



Chipsmall Limited consists of a professional team with an average of over 10 year of expertise in the distribution of electronic components. Based in Hongkong, we have already established firm and mutual-benefit business relationships with customers from,Europe,America and south Asia,supplying obsolete and hard-to-find components to meet their specific needs.

With the principle of "Quality Parts,Customers Priority,Honest Operation,and Considerate Service",our business mainly focus on the distribution of electronic components. Line cards we deal with include Microchip,ALPS,ROHM,Xilinx,Pulse,ON,Everlight and Freescale. Main products comprise IC,Modules,Potentiometer,IC Socket,Relay,Connector.Our parts cover such applications as commercial,industrial, and automotives areas.

We are looking forward to setting up business relationship with you and hope to provide you with the best service and solution. Let us make a better world for our industry!



## Contact us

Tel: +86-755-8981 8866 Fax: +86-755-8427 6832

Email & Skype: info@chipsmall.com Web: www.chipsmall.com

Address: A1208, Overseas Decoration Building, #122 Zhenhua RD., Futian, Shenzhen, China



## Small Signal Zener Diodes, Dual

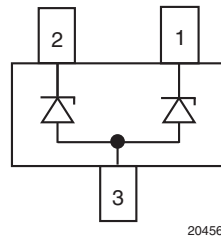

20456

### FEATURES

- Dual silicon planar Zener diodes, common anode
- The Zener voltages are graded according to the international E24 standard. Standard Zener voltage tolerance is  $\pm 5\%$ , indicated by the "C" in the ordering code. Replace "C" with "B" for 2% tolerance.
- The parameters are valid for both diodes in one case.  $\Delta V_Z$  and  $\Delta R_{zj}$  of the two diodes in one case is  $\leq 5\%$
- AEC-Q101 qualified available
- ESD capability according to AEC-Q101:  
Human body model > 8 kV  
Machine model > 800 V
- Base P/N-E3 - RoHS-compliant, commercial grade
- Base P/N-HE3 - RoHS-compliant, AEC-Q101 qualified
- Material categorization: for definitions of compliance please see [www.vishay.com/doc?99912](http://www.vishay.com/doc?99912)

 AUTOMOTIVE  
GRADE  
Available

**RoHS**  
COMPLIANT

### PRIMARY CHARACTERISTICS

| PARAMETER             | VALUE             | UNIT |
|-----------------------|-------------------|------|
| $V_Z$ range nom.      | 2.7 to 51         | V    |
| Test current $I_{ZT}$ | 5                 | mA   |
| $V_Z$ specification   | Pulse current     |      |
| Int. construction     | Dual common anode |      |

### ORDERING INFORMATION

| DEVICE NAME | ORDERING CODE                     | TAPED UNITS PER REEL           | MINIMUM ORDER QUANTITY |
|-------------|-----------------------------------|--------------------------------|------------------------|
| AZ23-series | AZ23C2V7-E3-08 to AZ23C51-E3-08   | 3000 (8 mm tape on 7" reel)    | 15 000                 |
|             | AZ23B2V7-E3-08 to AZ23B51-E3-08   |                                |                        |
|             | AZ23C2V7-HE3-08 to AZ23C51-HE3-08 |                                |                        |
|             | AZ23B2V7-HE3-08 to AZ23B51-HE3-08 |                                |                        |
|             | AZ23C2V7-E3-18 to AZ23C51-E3-18   | 10 000 (8 mm tape on 13" reel) | 10 000                 |
|             | AZ23B2V7-E3-18 to AZ23B51-E3-18   |                                |                        |
|             | AZ23C2V7-HE3-18 to AZ23C51-HE3-18 |                                |                        |
|             | AZ23B2V7-HE3-18 to AZ23B51-HE3-18 |                                |                        |

### PACKAGE

| PACKAGE NAME | WEIGHT | MOLDING COMPOUND<br>FLAMMABILITY RATING | MOISTURE SENSITIVITY<br>LEVEL        | SOLDERING<br>CONDITIONS  |
|--------------|--------|---|--------------------------------------|--------------------------|
| SOT-23       | 8.8 mg | UL 94 V-0                               | MSL level 1<br>(according J-STD-020) | 260 °C/10 s at terminals |

### ABSOLUTE MAXIMUM RATINGS ( $T_{amb} = 25\text{ °C}$ , unless otherwise specified)

| PARAMETER                                      | TEST CONDITION  | SYMBOL     | VALUE       | UNIT |
|--|---|------------|-------------|------|
| Power dissipation                              | Device on fiberglass substrate,<br>see layout on page 6 | $P_{tot}$  | 300         | mW   |
| Thermal resistance, junction<br>to ambient air | Device on fiberglass substrate,<br>see layout on page 6 | $R_{thJA}$ | 420         | K/W  |
| Junction temperature                           |   | $T_j$      | 150         | °C   |
| Storage temperature range                      |   | $T_{stg}$  | -65 to +150 | °C   |
| Operating temperature range                    |   | $T_{op}$   | -55 to +150 | °C   |



| <b>ELECTRICAL CHARACTERISTICS</b> ( $T_{amb} = 25\text{ }^{\circ}\text{C}$ , unless otherwise specified) |              |                                    |      |      |              |           |                 |     |                    |                       |  |      |
|--|--------------|------------------------------------|------|------|--------------|-----------|-----------------|-----|--------------------|-----------------------|--|------|
| PART NUMBER  | MARKING CODE | ZENER VOLTAGE RANGE <sup>(1)</sup> |      |      | TEST CURRENT |           | REVERSE VOLTAGE |     | DYNAMIC RESISTANCE |                       | TEMPERATURE COEFFICIENT OF ZENER VOLTAGE |      |
|  |              | $V_Z$ at $I_{ZT1}$                 |      |      | $I_{ZT1}$    | $I_{ZT2}$ | $V_R$ at $I_R$  |     | $Z_Z$ at $I_{ZT1}$ | $Z_{ZK}$ at $I_{ZT2}$ | $\alpha_{VZ}$ at $I_{ZT}$                |      |
|  |              | V                                  |      |      | mA           |           | V               | nA  | $\Omega$           |                       | $10^{-4}/^{\circ}\text{C}$               |      |
|  |              | MIN.                               | NOM. | MAX. |              |           |                 |     |                    |                       | MIN.                                     | MAX. |
| AZ23C2V7   | D1           | 2.5                                | 2.7  | 2.9  | 5            | 1         | -               | -   | 75 (< 83)          | < 500                 | -9                                       | -4   |
| AZ23C3V0   | D2           | 2.8                                | 3.0  | 3.2  | 5            | 1         | -               | -   | 80 (< 95)          | < 500                 | -9                                       | -3   |
| AZ23C3V3   | D3           | 3.1                                | 3.3  | 3.5  | 5            | 1         | -               | -   | 80 (< 95)          | < 500                 | -8                                       | -3   |
| AZ23C3V6   | D4           | 3.4                                | 3.6  | 3.8  | 5            | 1         | -               | -   | 80 (< 95)          | < 500                 | -8                                       | -3   |
| AZ23C3V9   | D5           | 3.7                                | 3.9  | 4.1  | 5            | 1         | -               | -   | 80 (< 95)          | < 500                 | -7                                       | -3   |
| AZ23C4V3   | D6           | 4                                  | 4.3  | 4.6  | 5            | 1         | -               | -   | 80 (< 95)          | < 500                 | -6                                       | -1   |
| AZ23C4V7   | D7           | 4.4                                | 4.7  | 5    | 5            | 1         | -               | -   | 70 (< 78)          | < 500                 | -5                                       | 2    |
| AZ23C5V1   | D8           | 4.8                                | 5.1  | 5.4  | 5            | 1         | > 0.8           | 100 | 30 (< 60)          | < 480                 | -3                                       | 4    |
| AZ23C5V6   | D9           | 5.2                                | 5.6  | 6    | 5            | 1         | > 1             | 100 | 10 (< 40)          | < 400                 | -2                                       | 6    |
| AZ23C6V2   | D10          | 5.8                                | 6.2  | 6.6  | 5            | 1         | > 2             | 100 | 4.8 (< 10)         | < 200                 | -1                                       | 7    |
| AZ23C6V8   | D11          | 6.4                                | 6.8  | 7.2  | 5            | 1         | > 3             | 100 | 4.5 (< 8)          | < 150                 | 2  | 7    |
| AZ23C7V5   | D12          | 7                                  | 7.5  | 7.9  | 5            | 1         | > 5             | 100 | 4 (< 7)            | < 50                  | 3  | 7    |
| AZ23C8V2   | D13          | 7.7                                | 8.2  | 8.7  | 5            | 1         | > 6             | 100 | 4.5 (< 7)          | < 50                  | 4  | 7    |
| AZ23C9V1   | D14          | 8.5                                | 9.1  | 9.6  | 5            | 1         | > 7             | 100 | 4.8 (< 10)         | < 50                  | 5  | 8    |
| AZ23C10  | D15          | 9.4                                | 10   | 10.6 | 5            | 1         | > 7.5           | 100 | 5.2 (< 15)         | < 70                  | 5  | 8    |
| AZ23C11  | D16          | 10.4                               | 11   | 11.6 | 5            | 1         | > 8.5           | 100 | 6 (< 20)           | < 70                  | 5  | 9    |
| AZ23C12  | D17          | 11.4                               | 12   | 12.7 | 5            | 1         | > 9             | 100 | 7 (< 20)           | < 90                  | 6  | 9    |
| AZ23C13  | D18          | 12.4                               | 13   | 14.1 | 5            | 1         | > 10            | 100 | 9 (< 25)           | < 110                 | 7  | 9    |
| AZ23C15  | D19          | 13.8                               | 15   | 15.6 | 5            | 1         | > 11            | 100 | 11 (< 30)          | < 110                 | 7  | 9    |
| AZ23C16  | D20          | 15.3                               | 16   | 17.1 | 5            | 1         | > 12            | 100 | 13 (< 40)          | < 170                 | 8  | 9.5  |
| AZ23C18  | D21          | 16.8                               | 18   | 19.1 | 5            | 1         | > 14            | 100 | 18 (< 50)          | < 170                 | 8  | 9.5  |
| AZ23C20  | D22          | 18.8                               | 20   | 21.2 | 5            | 1         | > 15            | 100 | 20 (< 50)          | < 220                 | 8  | 10   |
| AZ23C22  | D23          | 20.8                               | 22   | 23.3 | 5            | 1         | > 17            | 100 | 25 (< 55)          | < 220                 | 8  | 10   |
| AZ23C24  | D24          | 22.8                               | 24   | 25.6 | 5            | 1         | > 18            | 100 | 28 (< 80)          | < 220                 | 8  | 10   |
| AZ23C27  | D25          | 25.1                               | 27   | 28.9 | 5            | 1         | > 20            | 100 | 30 (< 80)          | < 250                 | 8  | 10   |
| AZ23C30  | D26          | 28                                 | 30   | 32   | 5            | 1         | > 22.5          | 100 | 35 (< 80)          | < 250                 | 8  | 10   |
| AZ23C33  | D27          | 31                                 | 33   | 35   | 5            | 1         | > 25            | 100 | 40 (< 80)          | < 250                 | 8  | 10   |
| AZ23C36  | D28          | 34                                 | 36   | 38   | 5            | 1         | > 27            | 100 | 40 (< 90)          | < 250                 | 8  | 10   |
| AZ23C39  | D29          | 37                                 | 39   | 41   | 5            | 1         | > 29            | 100 | 50 (< 90)          | < 300                 | 10                                       | 12   |
| AZ23C43  | D30          | 40                                 | 43   | 46   | 5            | 1         | > 32            | 100 | 60 (< 100)         | < 700                 | 10                                       | 12   |
| AZ23C47  | D31          | 44                                 | 47   | 50   | 5            | 1         | > 35            | 100 | 70 (< 100)         | < 750                 | 10                                       | 12   |
| AZ23C51  | D32          | 48                                 | 51   | 54   | 5            | 1         | > 38            | 100 | 70 (< 100)         | < 750                 | 10                                       | 12   |

**Note**

<sup>(1)</sup> Tested with pulses  $t_p = 5\text{ ms}$



| <b>ELECTRICAL CHARACTERISTICS</b> ( $T_{amb} = 25\text{ }^{\circ}\text{C}$ , unless otherwise specified) |              |                                    |      |      |              |           |                 |     |                    |                       |  |      |
|--|--------------|------------------------------------|------|------|--------------|-----------|-----------------|-----|--------------------|-----------------------|--|------|
| PART NUMBER  | MARKING CODE | ZENER VOLTAGE RANGE <sup>(1)</sup> |      |      | TEST CURRENT |           | REVERSE VOLTAGE |     | DYNAMIC RESISTANCE |                       | TEMPERATURE COEFFICIENT OF ZENER VOLTAGE |      |
|  |              | $V_Z$ at $I_{ZT1}$                 |      |      | $I_{ZT1}$    | $I_{ZT2}$ | $V_R$ at $I_R$  |     | $Z_Z$ at $I_{ZT1}$ | $Z_{ZK}$ at $I_{ZT2}$ | $\alpha_{VZ}$ at $I_{ZT}$                |      |
|  |              | V                                  |      |      | mA           |           | V               | nA  | $\Omega$           |                       | $10^{-4}/^{\circ}\text{C}$               |      |
|  |              | MIN.                               | NOM. | MAX. |              |           |                 |     |                    |                       | MIN.                                     | MAX. |
| AZ23B2V7   | D1           | 2.65                               | 2.7  | 2.75 | 5            | 1         | -               | -   | 75 (< 83)          | < 500                 | -9                                       | -4   |
| AZ23B3V0   | D2           | 2.94                               | 3.0  | 3.06 | 5            | 1         | -               | -   | 80 (< 95)          | < 500                 | -9                                       | -3   |
| AZ23B3V3   | D3           | 3.23                               | 3.3  | 3.37 | 5            | 1         | -               | -   | 80 (< 95)          | < 500                 | -8                                       | -3   |
| AZ23B3V6   | D4           | 3.53                               | 3.6  | 3.67 | 5            | 1         | -               | -   | 80 (< 95)          | < 500                 | -8                                       | -3   |
| AZ23B3V9   | D5           | 3.82                               | 3.9  | 3.98 | 5            | 1         | -               | -   | 80 (< 95)          | < 500                 | -7                                       | -3   |
| AZ23B4V3   | D6           | 4.21                               | 4.3  | 4.39 | 5            | 1         | -               | -   | 80 (< 95)          | < 500                 | -6                                       | -1   |
| AZ23B4V7   | D7           | 4.61                               | 4.7  | 4.79 | 5            | 1         | -               | -   | 70 (< 78)          | < 500                 | -5                                       | 2    |
| AZ23B5V1   | D8           | 5                                  | 5.1  | 5.2  | 5            | 1         | > 0.8           | 100 | 30 (< 60)          | < 480                 | -3                                       | 4    |
| AZ23B5V6   | D9           | 5.49                               | 5.6  | 5.71 | 5            | 1         | > 1             | 100 | 10 (< 40)          | < 400                 | -2                                       | 6    |
| AZ23B6V2   | D10          | 6.08                               | 6.2  | 6.32 | 5            | 1         | > 2             | 100 | 4.8 (< 10)         | < 200                 | -1                                       | 7    |
| AZ23B6V8   | D11          | 6.66                               | 6.8  | 6.94 | 5            | 1         | > 3             | 100 | 4.5 (< 8)          | < 150                 | 2  | 7    |
| AZ23B7V5   | D12          | 7.35                               | 7.5  | 7.65 | 5            | 1         | > 5             | 100 | 4 (< 7)            | < 50                  | 3  | 7    |
| AZ23B8V2   | D13          | 8.04                               | 8.2  | 8.36 | 5            | 1         | > 6             | 100 | 4.5 (< 7)          | < 50                  | 4  | 7    |
| AZ23B9V1   | D14          | 8.92                               | 9.1  | 9.28 | 5            | 1         | > 7             | 100 | 4.8 (< 10)         | < 50                  | 5  | 8    |
| AZ23B10  | D15          | 9.8                                | 10   | 10.2 | 5            | 1         | > 7.5           | 100 | 5.2 (< 15)         | < 70                  | 5  | 8    |
| AZ23B11  | D16          | 10.8                               | 11   | 11.2 | 5            | 1         | > 8.5           | 100 | 6 (< 20)           | < 70                  | 5  | 9    |
| AZ23B12  | D17          | 11.8                               | 12   | 12.2 | 5            | 1         | > 9             | 100 | 7 (< 20)           | < 90                  | 6  | 9    |
| AZ23B13  | D18          | 12.7                               | 13   | 13.3 | 5            | 1         | > 10            | 100 | 9 (< 25)           | < 110                 | 7  | 9    |
| AZ23B15  | D19          | 14.7                               | 15   | 15.3 | 5            | 1         | > 11            | 100 | 11 (< 30)          | < 110                 | 7  | 9    |
| AZ23B16  | D20          | 15.7                               | 16   | 16.3 | 5            | 1         | > 12            | 100 | 13 (< 40)          | < 170                 | 8  | 0.5  |
| AZ23B18  | D21          | 17.6                               | 18   | 18.4 | 5            | 1         | > 14            | 100 | 18 (< 50)          | < 170                 | 8  | 0.5  |
| AZ23B20  | D22          | 19.6                               | 20   | 20.4 | 5            | 1         | > 15            | 100 | 20 (< 50)          | < 220                 | 8  | 10   |
| AZ23B22  | D23          | 21.6                               | 22   | 22.4 | 5            | 1         | > 17            | 100 | 25 (< 55)          | < 220                 | 8  | 10   |
| AZ23B24  | D24          | 23.5                               | 24   | 24.5 | 5            | 1         | > 18            | 100 | 28 (< 80)          | < 220                 | 8  | 10   |
| AZ23B27  | D25          | 26.5                               | 27   | 27.5 | 5            | 1         | > 20            | 100 | 30 (< 80)          | < 250                 | 8  | 10   |
| AZ23B30  | D26          | 29.4                               | 30   | 30.6 | 5            | 1         | > 22.5          | 100 | 35 (< 80)          | < 250                 | 8  | 10   |
| AZ23B33  | D27          | 32.3                               | 33   | 33.7 | 5            | 1         | > 25            | 100 | 40 (< 80)          | < 250                 | 8  | 10   |
| AZ23B36  | D28          | 35.3                               | 36   | 36.7 | 5            | 1         | > 27            | 100 | 40 (< 90)          | < 250                 | 8  | 10   |
| AZ23B39  | D29          | 38.2                               | 39   | 39.8 | 5            | 1         | > 29            | 100 | 50 (< 90)          | < 300                 | 10                                       | 12   |
| AZ23B43  | D30          | 42.1                               | 43   | 43.9 | 5            | 1         | > 32            | 100 | 60 (< 100)         | < 700                 | 10                                       | 12   |
| AZ23B47  | D31          | 46.1                               | 47   | 47.9 | 5            | 1         | > 35            | 100 | 70 (< 100)         | < 750                 | 10                                       | 12   |
| AZ23B51  | D32          | 50                                 | 51   | 52   | 5            | 1         | > 38            | 100 | 70 (< 100)         | < 750                 | 10                                       | 12   |

**Note**

<sup>(1)</sup> Tested with pulses  $t_p = 5\text{ ms}$

**TYPICAL CHARACTERISTICS** ( $T_{amb} = 25\text{ }^{\circ}\text{C}$ , unless otherwise specified)

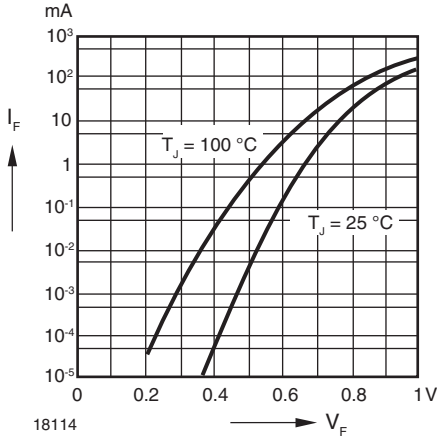

Fig. 1 - Forward Characteristics

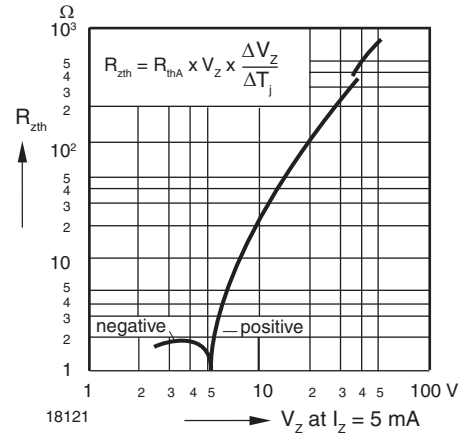

Fig. 4 - Thermal Differential Resistance vs. Zener Voltage

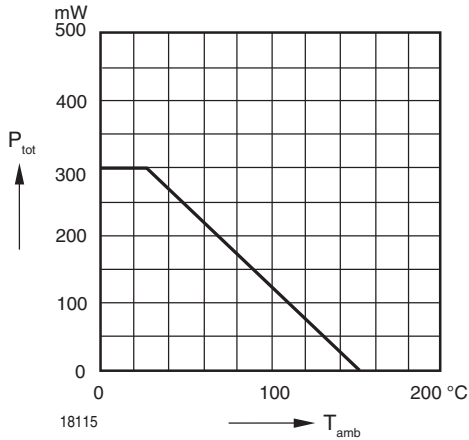

Fig. 2 - Admissible Power Dissipation vs. Ambient Temperature

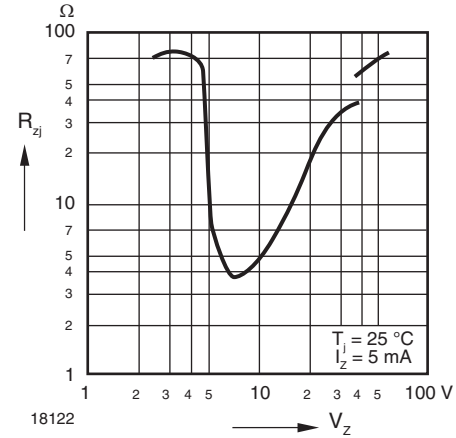

Fig. 5 - Dynamic Resistance vs. Zener Voltage

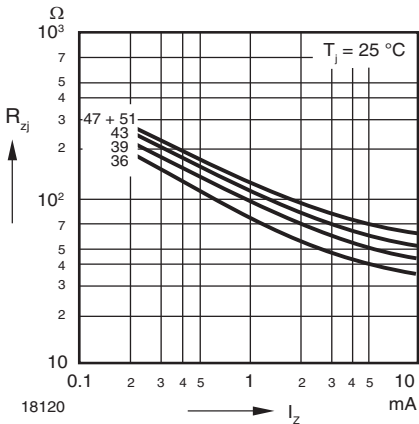

Fig. 3 - Dynamic Resistance vs. Zener Current

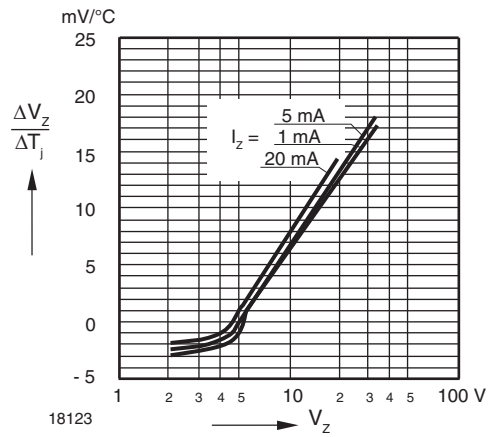

Fig. 6 - Temperature Dependence of Zener Voltage vs. Zener Voltage

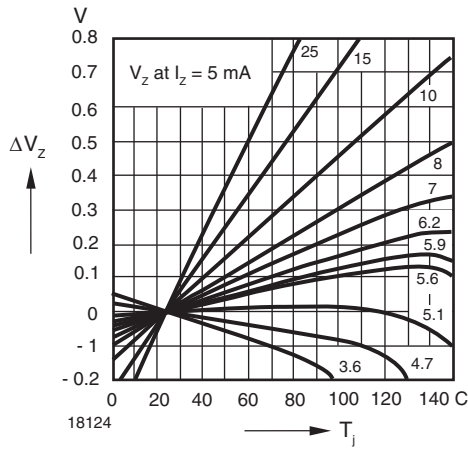

Fig. 7 - Change of Zener Voltage vs. Junction Temperature

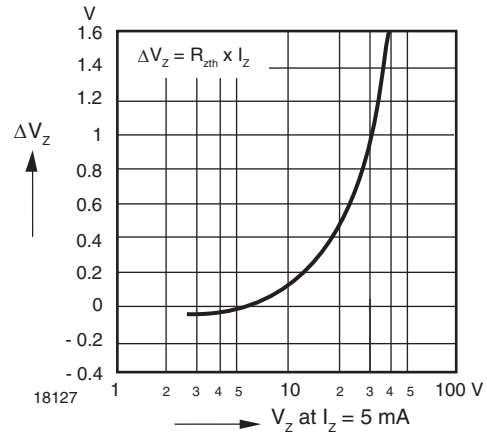

Fig. 10 - Change of Zener Voltage from Turn-on up to the Point of Thermal Equilibrium vs. Zener Voltage

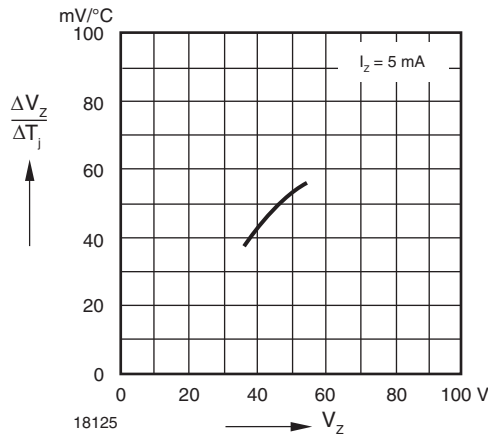

Fig. 8 - Temperature Dependence of Zener Voltage vs. Zener Voltage

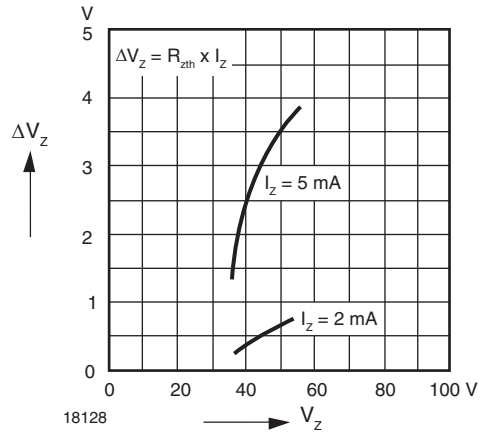

Fig. 11 - Change of Zener Voltage from Turn-on up to the Point of Thermal Equilibrium vs. Zener Voltage

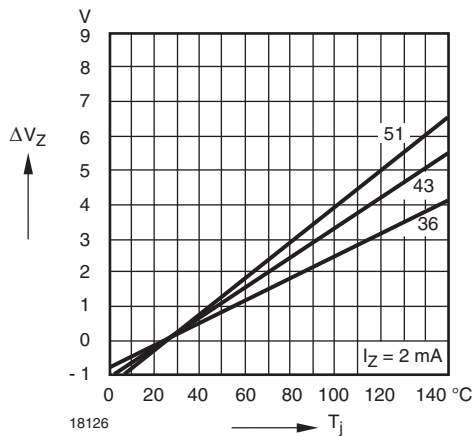

Fig. 9 - Change of Zener Voltage vs. Junction Temperature

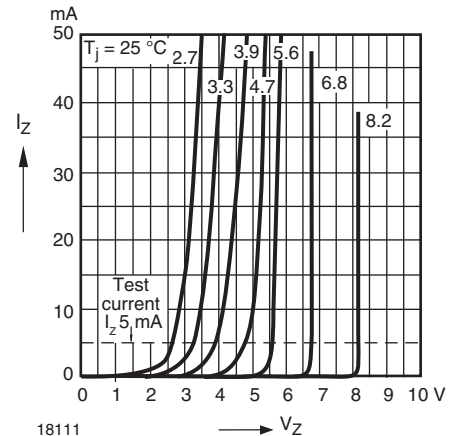

Fig. 12 - Breakdown Characteristics

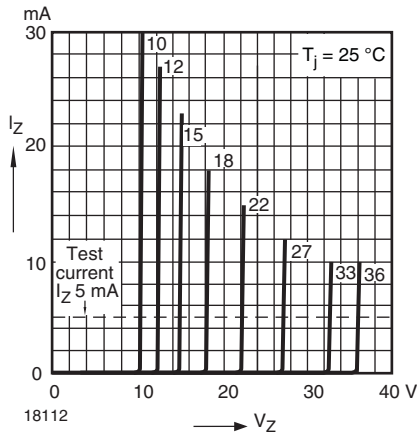

Fig. 13 - Breakdown Characteristics

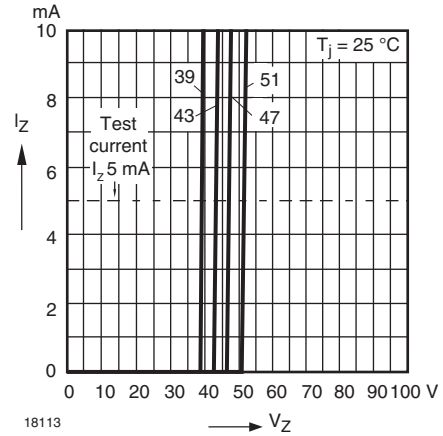
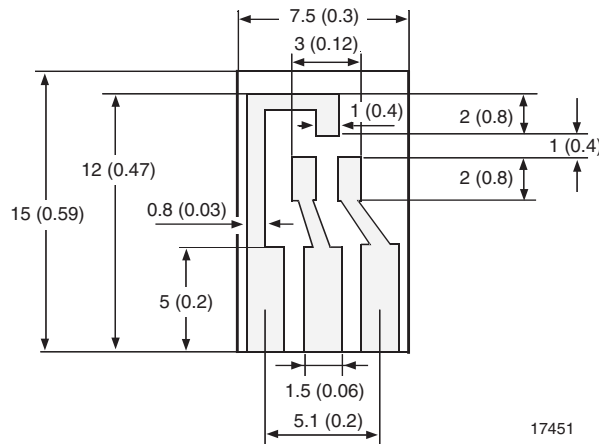

Fig. 14 - Breakdown Characteristics

**LAYOUT FOR R<sub>thJA</sub> TEST**

Thickness: fiberglass 0.059" (1.5 mm)

Copper leads 0.012" (0.3 mm)





### PACKAGE DIMENSIONS in millimeters (inches): SOT-23

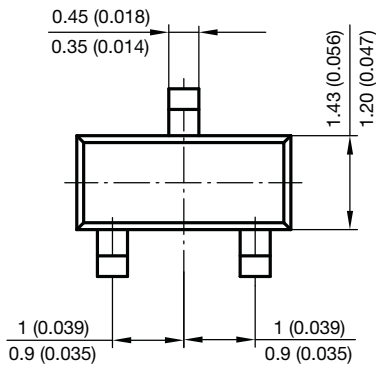
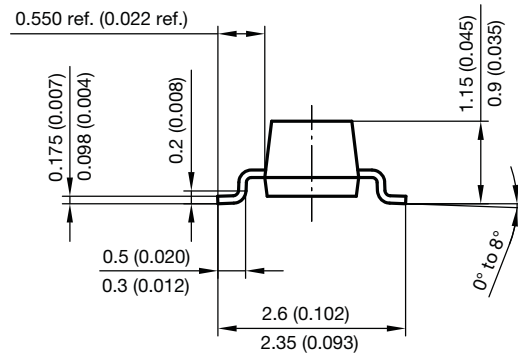
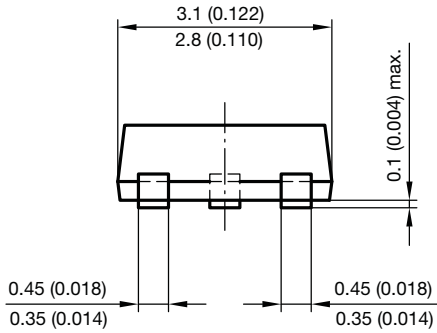

Foot print recommendation:

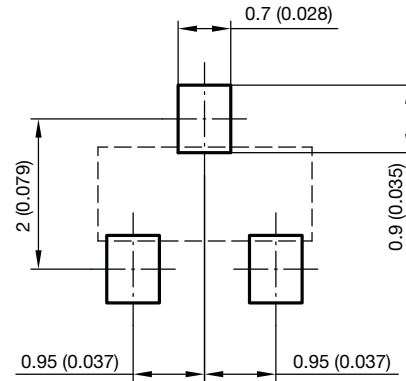

Document no.: 6.541-5014.01-4  
Rev. 8 - Date: 23.Sept.2009  
17418





## **Disclaimer**

ALL PRODUCT, PRODUCT SPECIFICATIONS AND DATA ARE SUBJECT TO CHANGE WITHOUT NOTICE TO IMPROVE RELIABILITY, FUNCTION OR DESIGN OR OTHERWISE.

Vishay Intertechnology, Inc., its affiliates, agents, and employees, and all persons acting on its or their behalf (collectively, "Vishay"), disclaim any and all liability for any errors, inaccuracies or incompleteness contained in any datasheet or in any other disclosure relating to any product.

Vishay makes no warranty, representation or guarantee regarding the suitability of the products for any particular purpose or the continuing production of any product. To the maximum extent permitted by applicable law, Vishay disclaims (i) any and all liability arising out of the application or use of any product, (ii) any and all liability, including without limitation special, consequential or incidental damages, and (iii) any and all implied warranties, including warranties of fitness for particular purpose, non-infringement and merchantability.

Statements regarding the suitability of products for certain types of applications are based on Vishay's knowledge of typical requirements that are often placed on Vishay products in generic applications. Such statements are not binding statements about the suitability of products for a particular application. It is the customer's responsibility to validate that a particular product with the properties described in the product specification is suitable for use in a particular application. Parameters provided in datasheets and / or specifications may vary in different applications and performance may vary over time. All operating parameters, including typical parameters, must be validated for each customer application by the customer's technical experts. Product specifications do not expand or otherwise modify Vishay's terms and conditions of purchase, including but not limited to the warranty expressed therein.

Except as expressly indicated in writing, Vishay products are not designed for use in medical, life-saving, or life-sustaining applications or for any other application in which the failure of the Vishay product could result in personal injury or death. Customers using or selling Vishay products not expressly indicated for use in such applications do so at their own risk. Please contact authorized Vishay personnel to obtain written terms and conditions regarding products designed for such applications.

No license, express or implied, by estoppel or otherwise, to any intellectual property rights is granted by this document or by any conduct of Vishay. Product names and markings noted herein may be trademarks of their respective owners.