



Chipsmall Limited consists of a professional team with an average of over 10 year of expertise in the distribution of electronic components. Based in Hongkong, we have already established firm and mutual-benefit business relationships with customers from,Europe,America and south Asia,supplying obsolete and hard-to-find components to meet their specific needs.

With the principle of “Quality Parts,Customers Priority,Honest Operation,and Considerate Service”,our business mainly focus on the distribution of electronic components. Line cards we deal with include Microchip,ALPS,ROHM,Xilinx,Pulse,ON,Everlight and Freescale. Main products comprise IC,Modules,Potentiometer,IC Socket,Relay,Connector.Our parts cover such applications as commercial,industrial, and automotives areas.

We are looking forward to setting up business relationship with you and hope to provide you with the best service and solution. Let us make a better world for our industry!



## Contact us

Tel: +86-755-8981 8866 Fax: +86-755-8427 6832

Email & Skype: info@chipsmall.com Web: www.chipsmall.com

Address: A1208, Overseas Decoration Building, #122 Zhenhua RD., Futian, Shenzhen, China



# Inductors And Common Mode Chokes

For Use in ADSL POTS Low Pass Filters

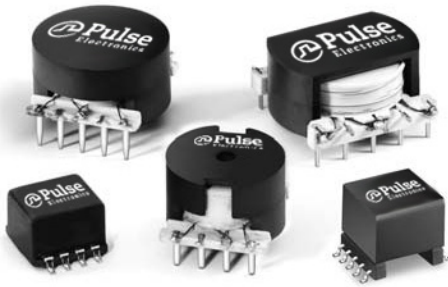

- Excellent longitudinal balance
- Inductors also available in surface mount packages
- Customized inductance values available
- Inductance is stable within  $\pm 10\%$  with DC current from 0 to 100mA

## Electrical Specifications @ 25°C - Operating Temperature -40°C to +125°C

RoHS-5 Compliant Part No.	RoHS-6 Compliant Part No.	Inductance (each winding) (mH)	DC Resistance (each winding) ( $\Omega$ MAX)	Isolation Voltage (between windings) (Vrms)	Function	Mounting
B2005	B2005NL	9.0 $\pm$ 30%	0.60	1500	Common Mode Choke	THT
B2013 <sup>3</sup>	B20013NL <sup>3</sup>	9.0 $\pm$ 30%	1.00	1500	Common Mode Choke	SMT
B2023	-	6.0 $\pm$ 5%	4.00	1500	Coupled Inductor for POTS Low Pass Filter	THT
B2024	-	4.0 $\pm$ 5%	3.00	1500	Coupled Inductor for POTS Low Pass Filter	THT
B2025	-	3.0 $\pm$ 5%	2.50	1500	Coupled Inductor for POTS Low Pass Filter	THT
B2026	-	10.0 $\pm$ 5%	4.50	1500	Coupled Inductor for POTS Low Pass Filter	THT
B2086 <sup>3</sup>	B2086NL <sup>3</sup>	4.0 $\pm$ 10%	3.60	1250	Coupled Inductor for POTS Low Pass Filter	SMT
B2113	-	2.25 $\pm$ 10%	2.25	500	Coupled Inductor for POTS Low Pass Filter	THT
B2114	-	1.425 $\pm$ 10%	2.25	500	Coupled Inductor for POTS Low Pass Filter	THT
B2116	-	1.65 $\pm$ 10%	2.25	500	Coupled Inductor for POTS Low Pass Filter	THT
B2117	-	1.35 $\pm$ 10%	2.25	500	Coupled Inductor for POTS Low Pass Filter	THT
B2118	-	0.8 $\pm$ 10%	2.00	500	Coupled Inductor for POTS Low Pass Filter	THT
B8098 <sup>3</sup>	B8098NL <sup>3</sup>	4.0 $\pm$ 10%	3.60	1250	Coupled Inductor for POTS Low Pass Filter	SMT

1. 100kHz, 20mVrms. 2. 1.0kHz, 1.0Vrms, 0 mA (each winding). 3. For Tape & Reel packaging, add the suffix "T" to this part number (B2013T or B2013NLT)

**Notes:** The B2005 and B2013 are common mode chokes that reduce common mode voltages in the low frequency range that may be caused by telephone ringing signals or by interference from radio transmitters in the ADSL frequency range. The chokes are also designed to accommodate DC currents up to 100mA.

### Mechanical

### Schematic

#### B2024 / B2025 / B2113 / B2114 / B2116 / B2117

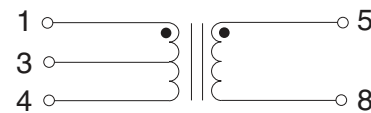
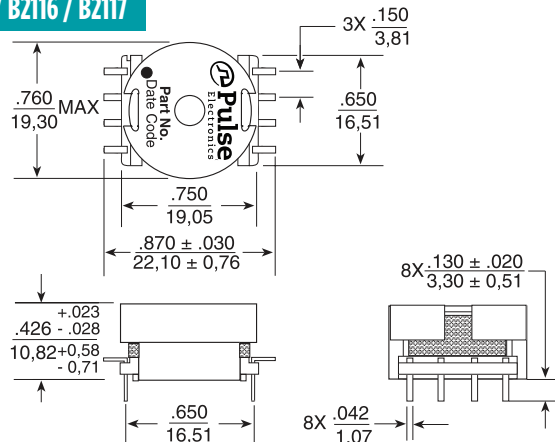

Weight .....9.5 grams

Tray .....30/tray

Dimensions:  $\frac{\text{Inches}}{\text{mm}}$

Unless otherwise specified, all tolerances are  $\pm \frac{.010}{0,25}$

USA 858 674 8100

Germany 49 7032 7806 0

Singapore 65 6287 8998

Shanghai 86 21 62787060

China 86 755 33966678

Taiwan 886 3 4356768

# Inductors And Common Mode Chokes

For Use in ADSL POTS Low Pass Filters



## Mechanicals

## Schematics

### B2118

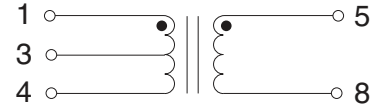
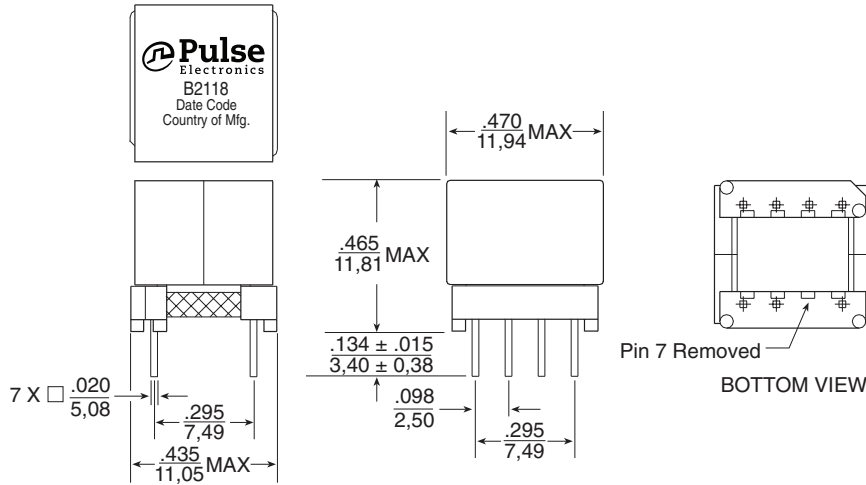

Weight .....3.6 grams

Tray .....75/tray

Dimensions:  $\frac{\text{Inches}}{\text{mm}}$

Unless otherwise specified,  
all tolerances are ±  $\frac{.010}{0,25}$

### B2023

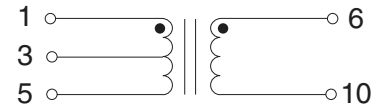
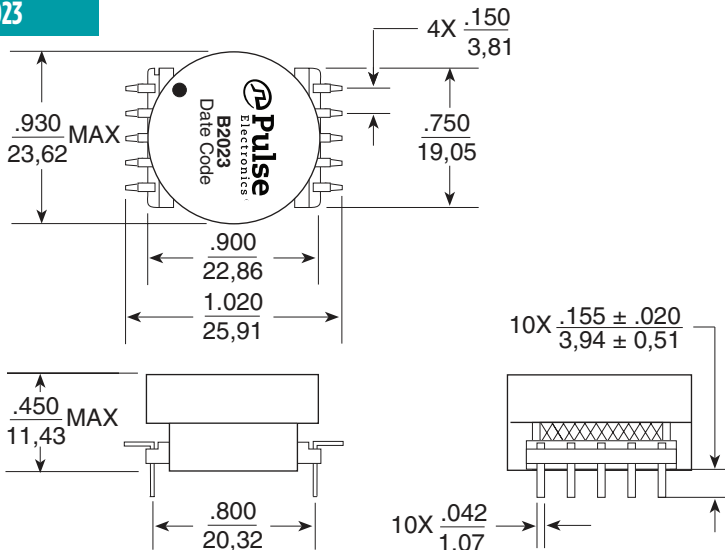

Weight .....15.0 grams

Tray .....45/tray

Dimensions:  $\frac{\text{Inches}}{\text{mm}}$

Unless otherwise specified,  
all tolerances are ±  $\frac{.010}{0,25}$

### B2026

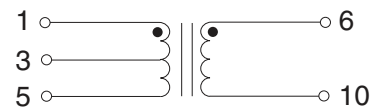
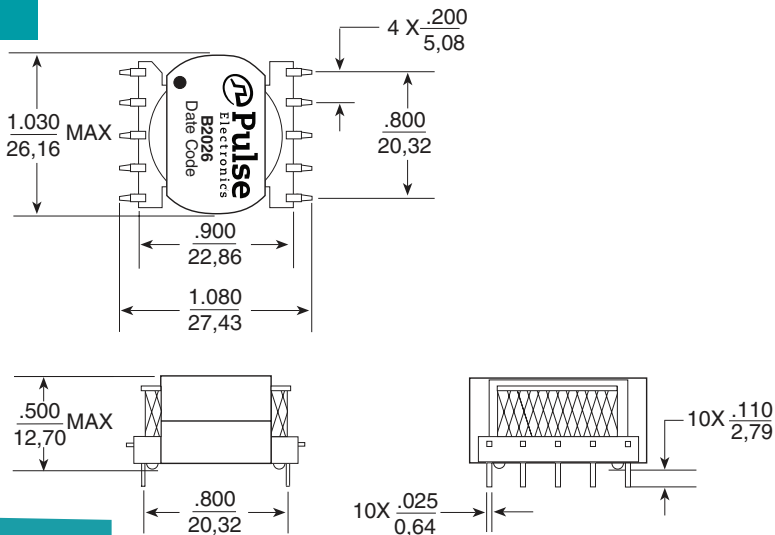

Weight .....17.5 grams

Tray .....25/tray

Dimensions:  $\frac{\text{Inches}}{\text{mm}}$

Unless otherwise specified,  
all tolerances are ±  $\frac{.010}{0,25}$

# Inductors And Common Mode Chokes

For Use in ADSL POTS Low Pass Filters



## Mechanicals

## Schematics

### B2086 / B2086NL / B8098 / B8098NL

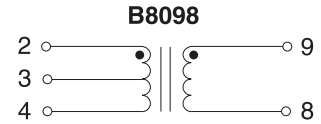
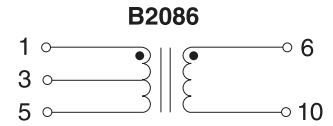
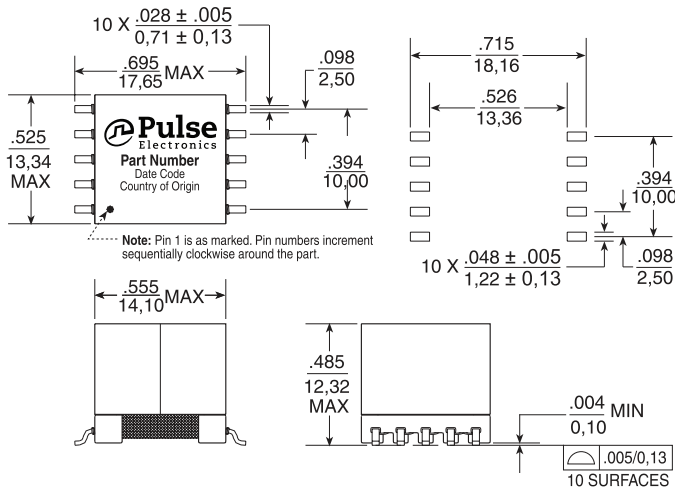

Weight .....6.2 grams  
 Tape & Reel .....150/reel  
 Tray .....60/tray  
 Dimensions:  $\frac{\text{Inches}}{\text{mm}}$

Unless otherwise specified,  
 all tolerances are  $\pm \frac{.010}{0,25}$

### B2005 / B2005NL

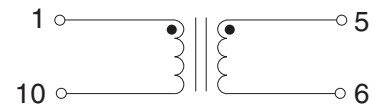
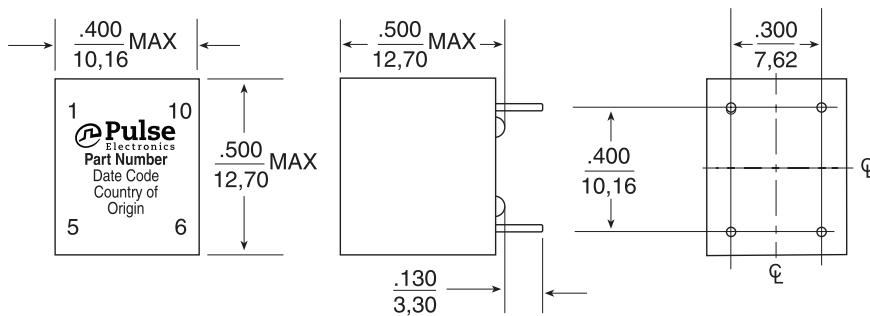

Weight .....3.7 grams  
 Tray .....40/tray  
 Dimensions:  $\frac{\text{Inches}}{\text{mm}}$

Unless otherwise specified,  
 all tolerances are  $\pm \frac{.010}{0,25}$

### B2013 / B2013NL

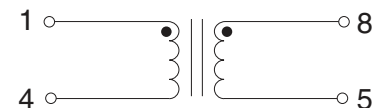
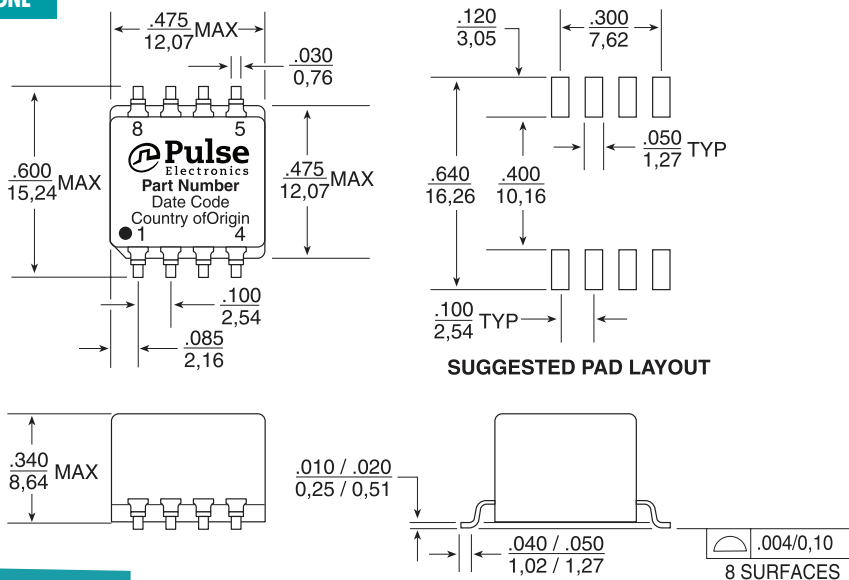

Weight .....2.5 grams  
 Tape & Reel .....250/reel  
 Tray .....40/tray  
 Dimensions:  $\frac{\text{Inches}}{\text{mm}}$

Unless otherwise specified,  
 all tolerances are  $\pm \frac{.010}{0,25}$

# Inductors And Common Mode Chokes

For Use in ADSL POTS Low Pass Filters

## Performance Description

The series of coupled inductors shown on this data sheet are current and temperature, high self-resonant frequency, low ideal for use in Asymmetrical Digital Subscriber Line (ADSL) applications where a low pass filter is required to separate the voice frequencies from the data frequencies that are carried on an ADSL line. In spite of their small footprint and low profile, these coupled inductors provide excellent electrical performance. They have stable inductance with varying DC current and temperature, high self-resonant frequency, low coupling capacitance, and excellent balance. The common mode chokes were developed to reduce common mode voltages in the low frequency range that is used for voice transmission. The chokes are also designed to accommodate DC currents up to 100 mA.

## Application Circuit

The following schematic depicts a typical LC filter that incorporates the use of a common mode choke in addition to the LC network. As shown in the frequency response graph below, at low frequencies, the amplitude of the output signal is roughly equal to the amplitude of the

input signal. At higher frequencies, the amplitude of the output decreases. Thus, the network passes low frequency voice signals with only a small degree of attenuation, while it suppresses high frequency signals and acts as a low pass filter.

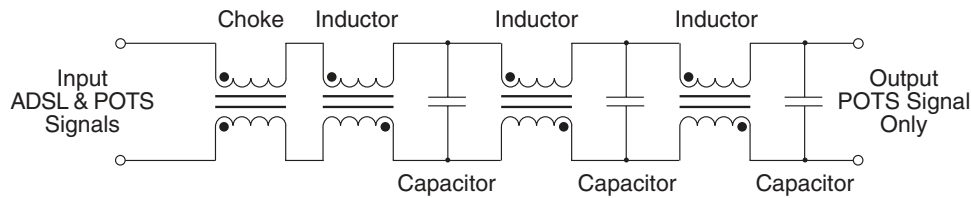

## Frequency Response

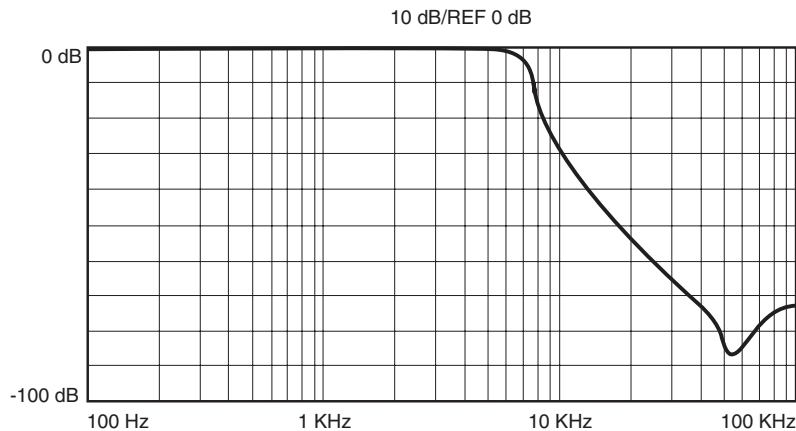

## For More Information

**Pulse Worldwide Headquarters**  
12220 World Trade Drive  
San Diego, CA  
92128  
U.S.A.

Tel: 858 674 8100  
Fax: 858 674 8262

**Pulse Europe**  
Einsteinstrasse 1  
D-71083 Herrenberg  
Germany

Tel: 49 7032 78060  
Fax: 49 7032 7806 135

**Pulse China Headquarters**  
B402, Shenzhen Academy of  
Aerospace Technol-  
ogy Bldg.  
10th Kejinan Road  
High-Tech Zone  
Nanshan District  
Shenzhen, PR China  
518057  
Tel: 86 755 33966678  
Fax: 86 755 33966700

**Pulse North China**  
Room 2704/2705  
Super Ocean Finance  
Ctr.  
2067 Yan An Road  
West  
Shanghai 200336  
China  
Tel: 86 21 62787060  
Fax: 86 2162786973

**Pulse South Asia**  
135 Joo Seng Road  
#03-02  
PM Industrial Bldg.  
Singapore 368363  
Tel: 65 6287 8998  
Fax: 65 6287 8998

**Pulse North Asia**  
3F, No. 198  
Zhongyuan Road  
Zhongli City  
Taoyuan County 320  
Taiwan R. O. C.  
Tel: 886 3 4356768  
Fax: 886 3 4356823 (Pulse)  
Fax: 886 3 4356820 (FRE)

Performance warranty of products offered on this data sheet is limited to the parameters specified. Data is subject to change without notice. Other brand and product names mentioned herein may be trademarks or registered trademarks of their respective owners. © Copyright, 2012. Pulse Electronics, Inc. All rights reserved.