



Chipsmall Limited consists of a professional team with an average of over 10 year of expertise in the distribution of electronic components. Based in Hongkong, we have already established firm and mutual-benefit business relationships with customers from,Europe,America and south Asia,supplying obsolete and hard-to-find components to meet their specific needs.

With the principle of "Quality Parts,Customers Priority,Honest Operation,and Considerate Service",our business mainly focus on the distribution of electronic components. Line cards we deal with include Microchip,ALPS,ROHM,Xilinx,Pulse,ON,Everlight and Freescale. Main products comprise IC,Modules,Potentiometer,IC Socket,Relay,Connector.Our parts cover such applications as commercial,industrial, and automotives areas.

We are looking forward to setting up business relationship with you and hope to provide you with the best service and solution. Let us make a better world for our industry!



## Contact us

Tel: +86-755-8981 8866 Fax: +86-755-8427 6832

Email & Skype: info@chipsmall.com Web: www.chipsmall.com

Address: A1208, Overseas Decoration Building, #122 Zhenhua RD., Futian, Shenzhen, China





### FEATURES

- Wide input voltage range, 18~60V
- 200W Output @ 18V~27V Vin range(for A/B/C/D/H)
- 300W Output @ 27~60V Vin range (for A/B/C/D/H)
- 300W Output @ 18V~60V Vin range(for DP)
- Full Load Efficiency up to 88.3% @48Vin
- Intergrated fuse holder (option)
- Parallel Connection of multiple units
- Box type package with metal base plate
- Package Dimension:  
190.0x76.0x44.0mm (7.48"x2.99"x1.73")
- Operating Temperature Range - 40°C to +75°C
- Input Reverse Polarity Protection
- Minimized Inrush current
- Input UVLO, Output OCL, Short circuit protection, OVP, OTP
- Enable on/off (option)
- 2250VDC Isolation
- IP67 protection for selective model
- RoHs Compliant
- ISO 9001, ISO 14001 certified manufacturing facility
- UL60950
- CE Mark
- EMC compatible: EN12895, CISPR11 ClassA
- Electrical transient conduction: ISO7637-2

The B40SR12424, a wide input voltage range of 18~60V, and single isolated output converter, is the latest product offering from a world leader in power systems technology and manufacturing — Delta Electronics, Inc. Such box type DCDC converter can provide 300W (200W at Vin < 27V for A/B/C/D/H), 12.4V regulated DC output voltage with full load efficiency up to 88.3% @48Vin; The B40SR12424 offers input UVLO, output over current limit, short circuit, output over voltage, over temperature, and input reverse polarity protections. It has an option for intergrated fuse holder and enable on/off function. It also has parallel function; and allows a wide operating temperature range of -40°C to +75°C. With creative design technology and optimization of component placement, this converter possess outstanding electrical and thermal performance, as well as high reliability under extremly harsh operating conditions. The B40SR12424 meet IP67 protection(refer to "water protection level" specification).

### Input Characteristics

Item	Condition	Min.	Typ.	Max.	Unit
Continuous Input Voltage		18	48	60	VDC
Max Input voltage	10 minutes, normal operating			80	VDC
Input Under-Voltage Lockout, Turn-On Voltage Threshold		16	17	18	VDC
Input Under-Voltage Lockout, Turn-Off Voltage Threshold		14	15	16	VDC
Lockout Hysteresis Voltage		1	2	3	VDC
Maximum Input Current	Vin=18V, 100% Load(for A/B/C/D/H)		12.6	13.1	A
	Vin=18V, 100% Load(for DP)		18.8	19.5	A
No-Load Input Current	Vin=24V		85	110	mA
	Vin=48V		40	70	mA
Off converter input current	Vin=48V, enable off (C version)		8	15	mA
Reflected input ripple current	Vin=48V, Vpp			0.2	A
Max Reverse Polarity Input Voltage				60	VDC
Max Inrush current				10	A
Internal Input Fuse	Ø6.35mm*31.75mm	250V/30A Fast-acting fuse			



## Output Characteristics

Item	Conditions	Min.	Typ.	Max.	Unit
Operating Output Current Range	Vin=18V~27V(for A/B/C/D/H)	0		16	A
	Vin=27V~60V(for A/B/C/D/H)	0		24	A
	Vin=18V~60V(for DP)	0		24	A
Output Voltage Set Point	Vin=24V,36V,48V, Io=0	12.4	12.6	12.8	V
	Vin=24V, Io=16A(for A/B/C/D/H)	12.13	12.33	12.53	V
	Vin=24V, Io=24A(for DP)	12.0	12.2	12.4	V
	Vin=36V,48V, Io=24A	12.0	12.2	12.4	V
Output Voltage Ripple and Noise,	Vin=36V, 48V, peak to peak, 20MHz bandwidth		100	160	mV
	RMS		35	50	mV
	Vin=24V, Io=16A(for A/B/C/D/H) peak to peak, 20MHz bandwidth		60	90	mV
	RMS, Vin=24V, Io=16A(for A/B/C/D/H)		20	30	mV
	Vin=24V, Io=24A(for DP) peak to peak, 20MHz bandwidth		70	100	mV
Output Current Limit	RMS, Vin=24V, Io=24A(for DP)		25	35	mV
	Vin=24V (for A/B/C/D/H)	16.5	18.5	20.5	A
	Vin=24V (for DP)	25	28	31	A
Current share accuracy	Vin=36V, 48V	25	28	31	A
	Vin=36V, 48V		6	10	%
Start-up time(start _up time by Vin)	Vin=48V,full load (for A/B/C/D/DP/H)		750	900	mS
Start-up time(start _up time by Enable)	Vin=48V,full load (for C)		250	350	mS
Rise time			30	50	mS
Output Voltage Protection		13	15	17	V
Output Voltage Current Transient, positive and negative voltage step	Vin=24V, 8A to 12A load dynamic, 0.1A/us slew rate(for A/B/C/D/H)		100	150	mV
	Vin=36V,48V, 12A to 18A load dynamic, 0.1A/us slew rate		100	150	mV
	Vin=24V, 12A to 18A load dynamic, 0.1A/us slew rate(for DP)		160	260	mV
Maximum Output Capacitance	ESR>10mohm			5000	μF
Output overshoot				3	%
Efficiency @ 100% Load(16A)	Vin=24V(for A/B/C/D/H)	86.8	88.8		%
Efficiency @ 100% Load(24A)	Vin=24V(for DP)	86.5	88.5		%
Efficiency @ 100% Load(24A)	Vin=36V	86.5	88.5		%
Efficiency @ 100% Load(24A)	Vin=48V	86.3	88.3		%
Efficiency @ 60% Load(9.6A)	Vin=24V(for A/B/C/D/H)	87.6	89.6		%
Efficiency @ 60% Load(14.4A)	Vin=24V(for DP)	88.2	90.2		%
Efficiency @ 60% Load(14.4A)	Vin=36V	87.8	89.8		%
Efficiency @ 60% Load(14.4A)	Vin=48V	87.3	89.3		%

## General Characteristics

Item	Conditions	Min.	Typ.	Max.	Unit
Isolation Voltage,	Input to Output, Input to Case			2250	VDC
	Output to Case			550	VDC
Isolation Resistance, Input to Output		10			MΩ
Isolation Capacitance, Input to Output			6000		pF
Switching Frequency			175		KHz
MTBF	Ta=25°C, 80%load		0.7		Mhours
Weight			900		g

## Environmental Specifications

Parameter	Conditions	Min.	Max.	Unit
Storage Temperature Range		-40	+125	°C
Operating Temperature Range	Ambient Temperature	-40	+75	°C
Over Temperature Protection	NTC Temperature		118	°C
Humidity (non condensing)			95	% rel. H
Water Protection Level	With connector&fuseholder for B Without connector&fuseholder for A/C/D/DP/H	IP67		
Vibration	IEC 60068-2-6	10G/15~200HZ/3 PLANES		
Shock	IEC 60068-2-27	50G 3 PLANES		
Emission	EN12895	30-1000MHz 34-45dBuV/m		
Immunity	EN12895, EN61000-4-3	10V/m /27-1000MHz AM; 10V/m /900MHz PM		
ESD	EN12895, EN61000-4-2	Direct: ±2KV ±4KV; Air: ±2KV ±4KV ±8KV		

## Notes

- 1 Specifications typical at Ta=+25°C, nominal input voltage and rated full load output current unless otherwise noted.
- 2 Specifications are subject to change without notice.

## ELECTRICAL CURVES

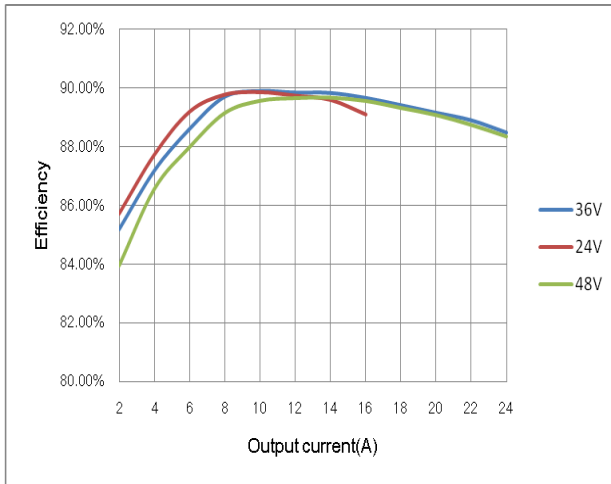

**Figure 1:** Efficiency vs. Output current  
Vin=24V,36V,48V (for A/B/C/D/H)

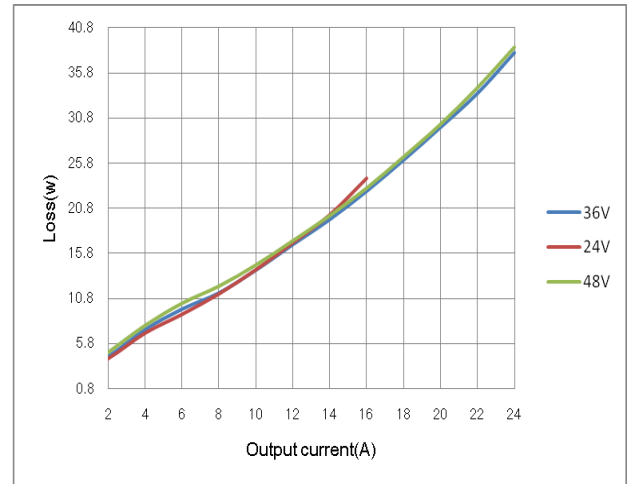

**Figure 2:** Loss vs. Output current  
@ Vin=24V,36V,48V (for A/B/C/D/H)

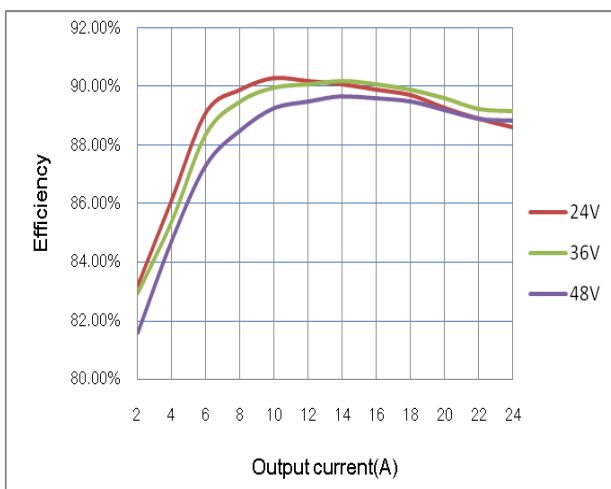

**Figure 3:** Efficiency vs. Output current  
Vin=24V,36V,48V (for DP)

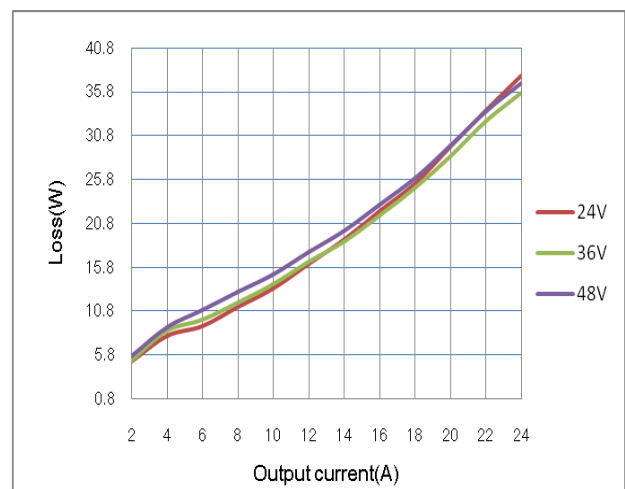

**Figure 4:** Loss vs. Output current  
@ Vin=24V,36V,48V(for DP)

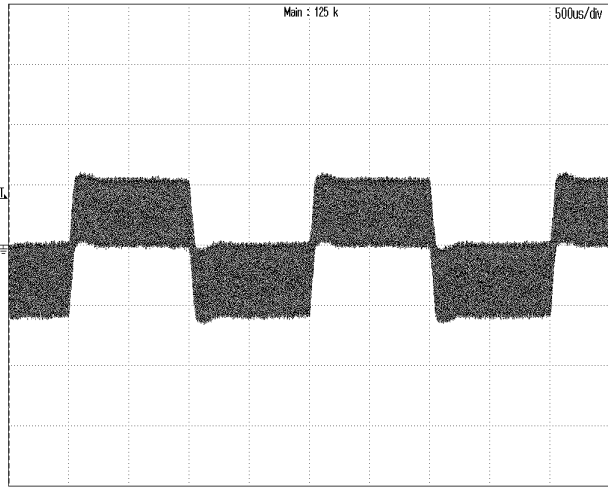

**Figure 5:** Dynamic response to load step 12A~18A with 0.1A/µS slew rate at 48Vin  
CH1:VOUT, 100mV/div, 500µS/div

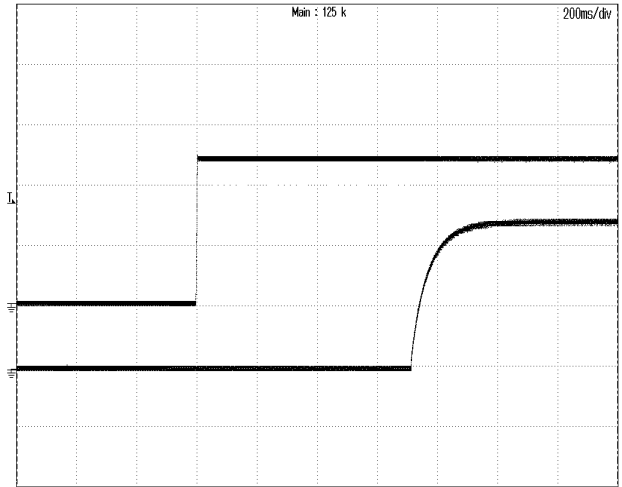

**Figure 6:** Vout start up with Vin on at 48Vin, 24A lout,  
TOP:VIN, 20V/div, 200mS/div  
BOTTOM: VOUT, 5V/div, 200mS/div

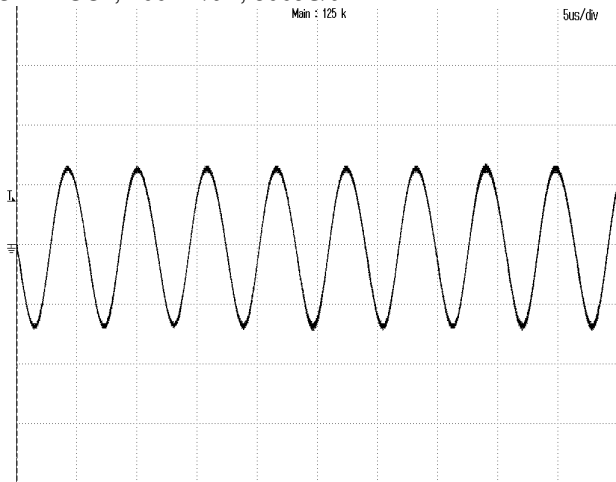

**Figure 7:** Output ripple & noise at 48Vin, 24A lout  
CH1:VOUT, 50mV/div, 5µS/div

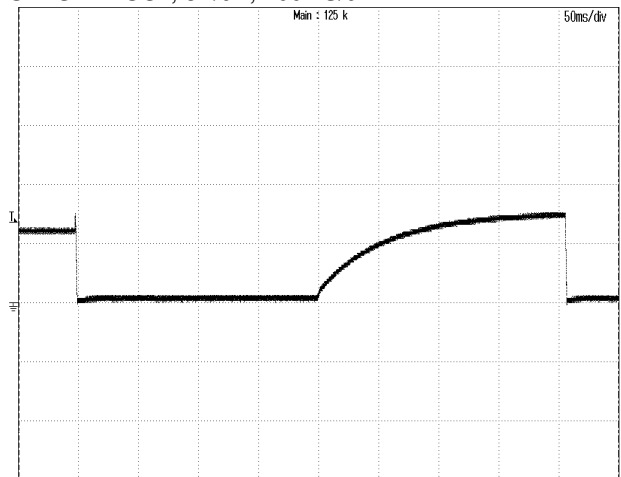

**Figure 8:** Output over voltage protection at 48Vin, 24A lout  
CH1:VOUT, 10V/div, 50mS/div

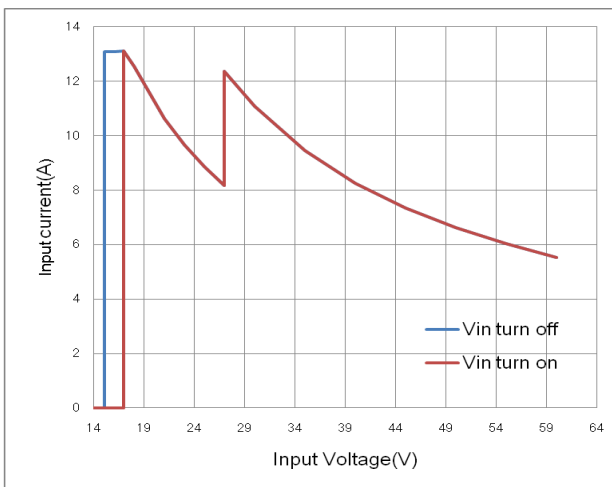

**Figure 9:** Input current vs. Input voltage  
@ Vin=18V~27V, 200W;  
Vin=27V~60V, 300W(for A/B/C/D/H)

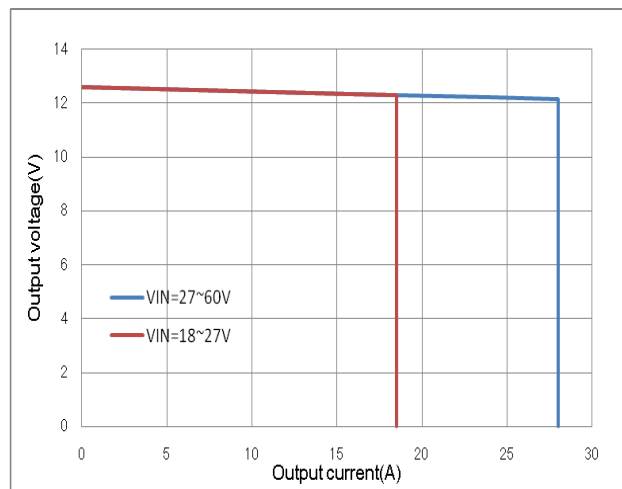

**Figure 10:** Output voltage vs. Output current  
OCL Performance (for A/B/C/D/H)

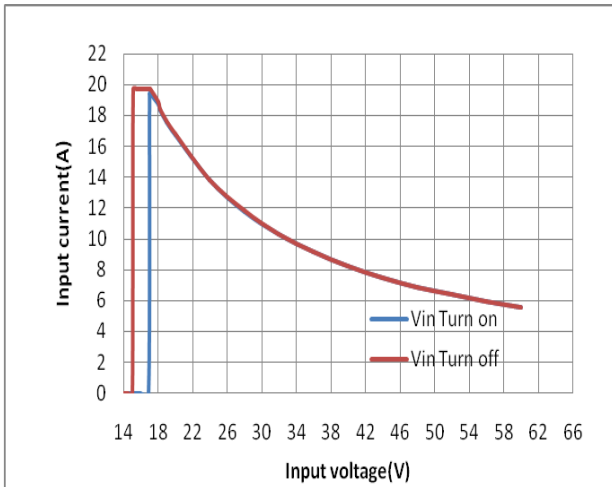

**Figure 11: Input current vs. Input voltage @ Vin=18V~60V, 300W (for DP)**

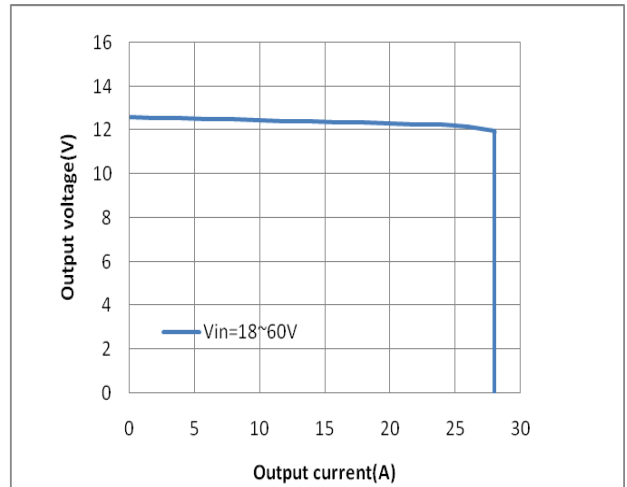

**Figure 12: Output voltage vs. Output current OCL Performance (for DP)**

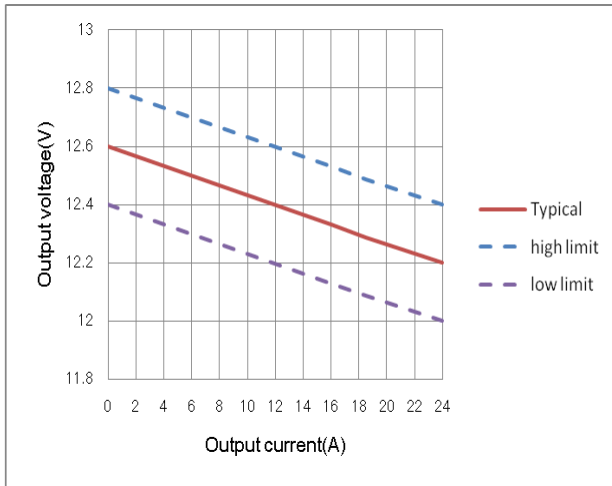

**Figure 13: Output voltage vs. Output current @ Vin=48V. Droop function.**

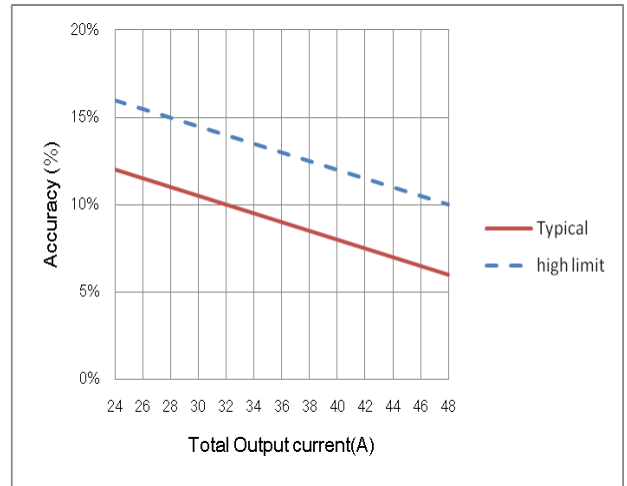

**Figure 14: Current share accuracy vs. Total output current 2 in parallel.**

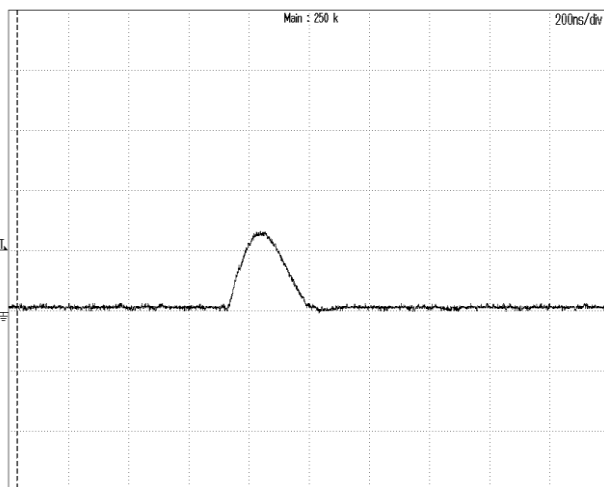

**Figure 15: Inrush current @ Vin=48V  
CH1:lin, 2A/div, 200nS/div  
Max current 2.7A, I2t=1.24E-7 A<sup>2</sup>S**

**Output Over-Current Limit and Short Protection**

The modules include internal output over-current limit (OCL) and short circuit protection (SCP) circuits, the OCL set point is lower than that of the SCP; The response of SCP circuit is much fast than that of the OCL circuit. The slowly increase of the output current will let module enter OCL protection when the current exceeds the OCL set point, while the fast increase of the output current will let module enter SCP when the current exceeds the SCP set point.

When the modules enter OCL protection, the output voltage will decrease while the output current is kept constant, the output voltage will soft start to set point when the overload condition is removed.

The module will enter hiccup mode when it triggers the SCP set point. The module will try to restart after shutdown. If the overload condition still exists, the module will shut down again. This restart trial will continue until the overload condition is removed.

**Output Over-Voltage Protection**

The power module includes an internal output over-voltage protection(OVP) circuit, which monitors the voltage on the output terminals. If this voltage exceeds the OVP set point, the module will shut down, and then restart after a fixed delay time (hiccup mode), please refer to figure8 for detail.

**Over-Temperature Protection**

The over-temperature protection consists of circuitry that provides protection from thermal damage. If the temperature exceeds the preset temperature threshold the module will shut down, and all components will not exceed their absolute maximum temperature ratings. The module will restart after the temperature is within specification.

**Remote On/Off**

B40SR12424C has Enable control function. This Enable PIN is designed on the primary side of converter, the converter will turn on when the Enable PIN connected to VIN+, and turn off when the Enable PIN connected to VIN- or floating.

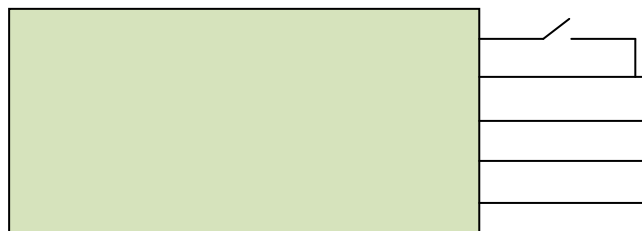

*Figure 16: suggested Enable connection*

**Input Reverse Voltage Protection**

The input reverse voltage protection is provided by an diode on the input line, the standoff voltage for the reverse protection shall be no less than -60V.

## DESIGN CONSIDERATIONS

### Parallel connection of multiple units

Two units parallel operation is verified, please contact Delta if more than two units need to be paralleled. While paralleling multiple units, the impedance of the cables from unit to junction point of each unit should be within  $\pm 5\%$  of each other.

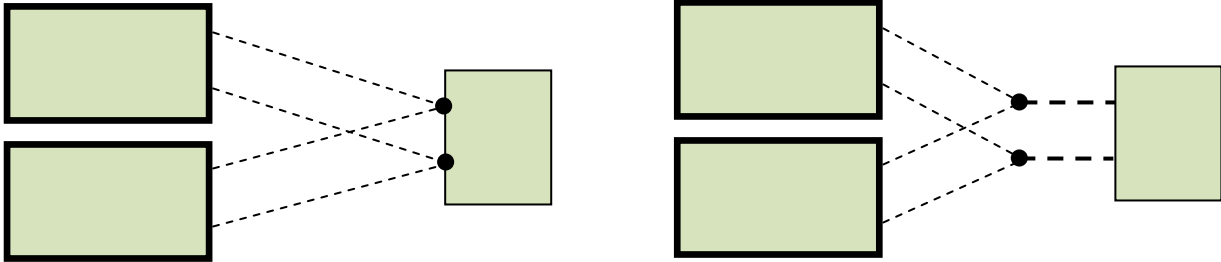

Figure 17: suggested parallel connections

### EMC

The converter has the internal EMI filters and meet the EMC standards EN12895 30-100MHz 34-45dBuV/m. The test result is showed as below

**Conditions:**  $V_{in}=48V$ ,  $I_o=24A$ , 10m measure distance

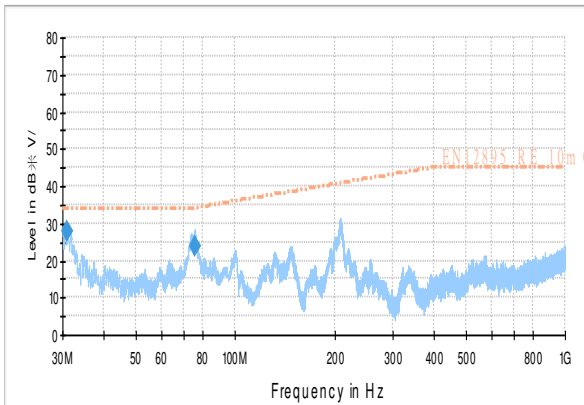

Figure 18: test result(Vertical)

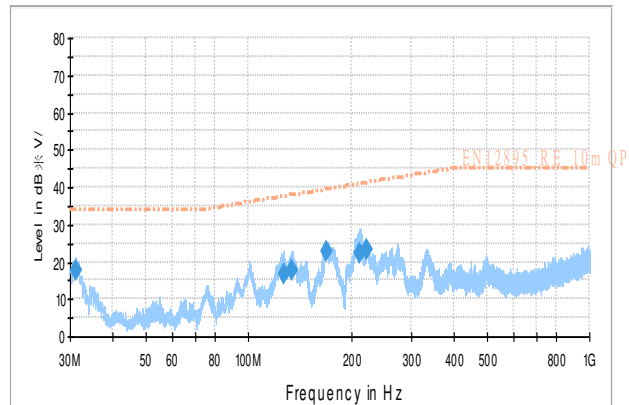

Figure 19: test result(Horizontal)

### Fuse replacement

For the versions with the intergrated the fuse holder, when the fuse needs to be replaced, it can be taken down in an anticlockwise direction by slotted type screwdrivers .

Recommended fuse replacement P/N:

Littlefuse 0314030.MXP



## THERMAL CONSIDERATION

The thermal curve (Figure21~23) is based on a 250x300x5 AL table, shown as below figure.

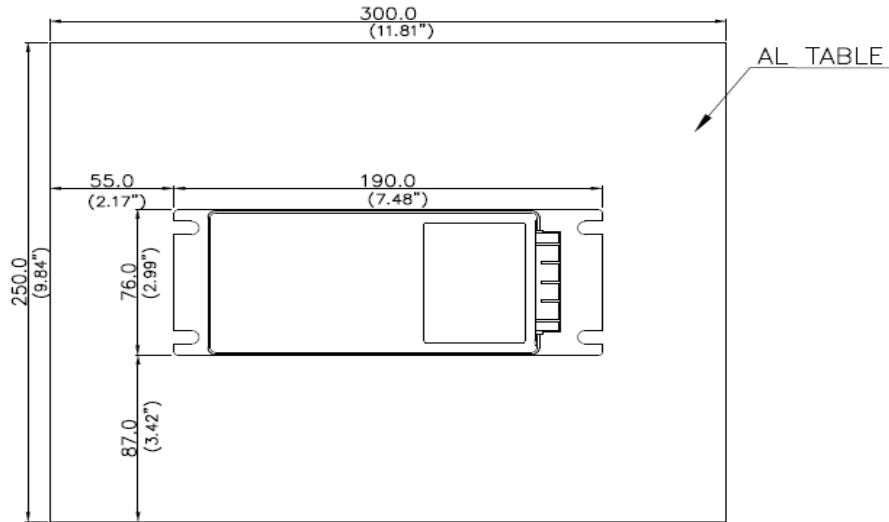

Figure 20: Thermal consideration

## THERMAL CURVE

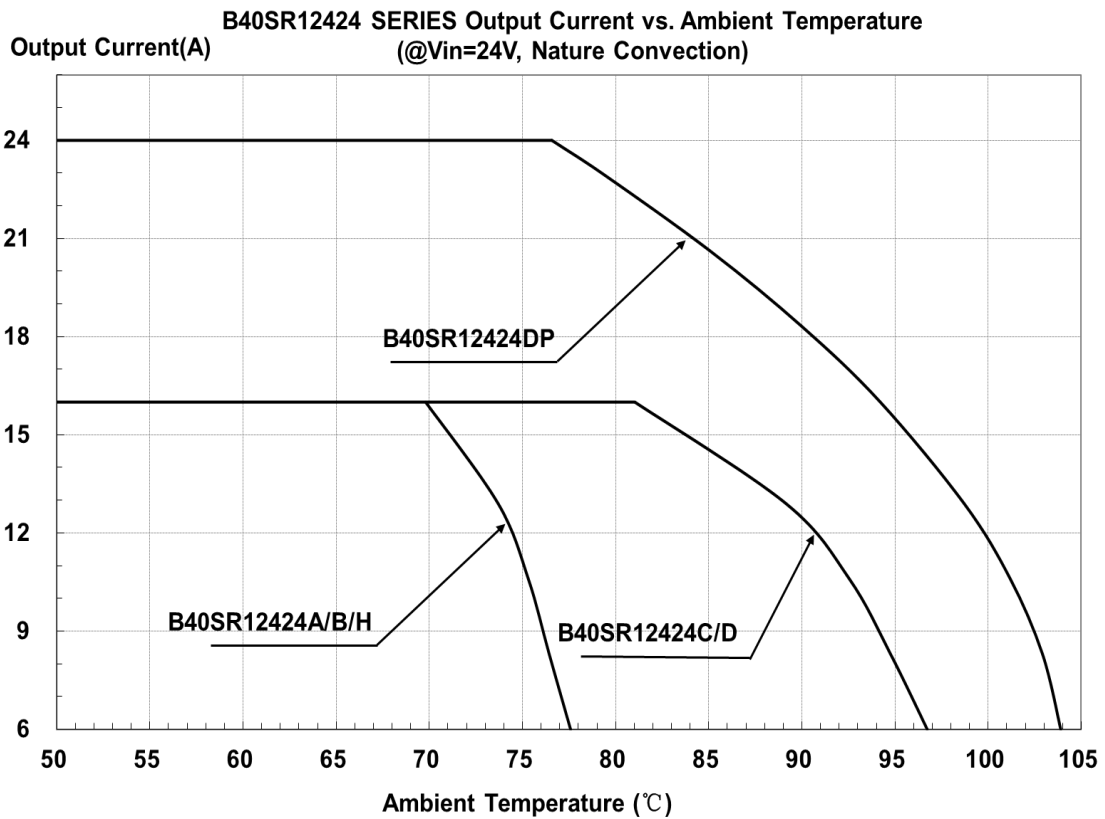

Figure 21: Output Current vs. Ambient temperature @Vin=24V

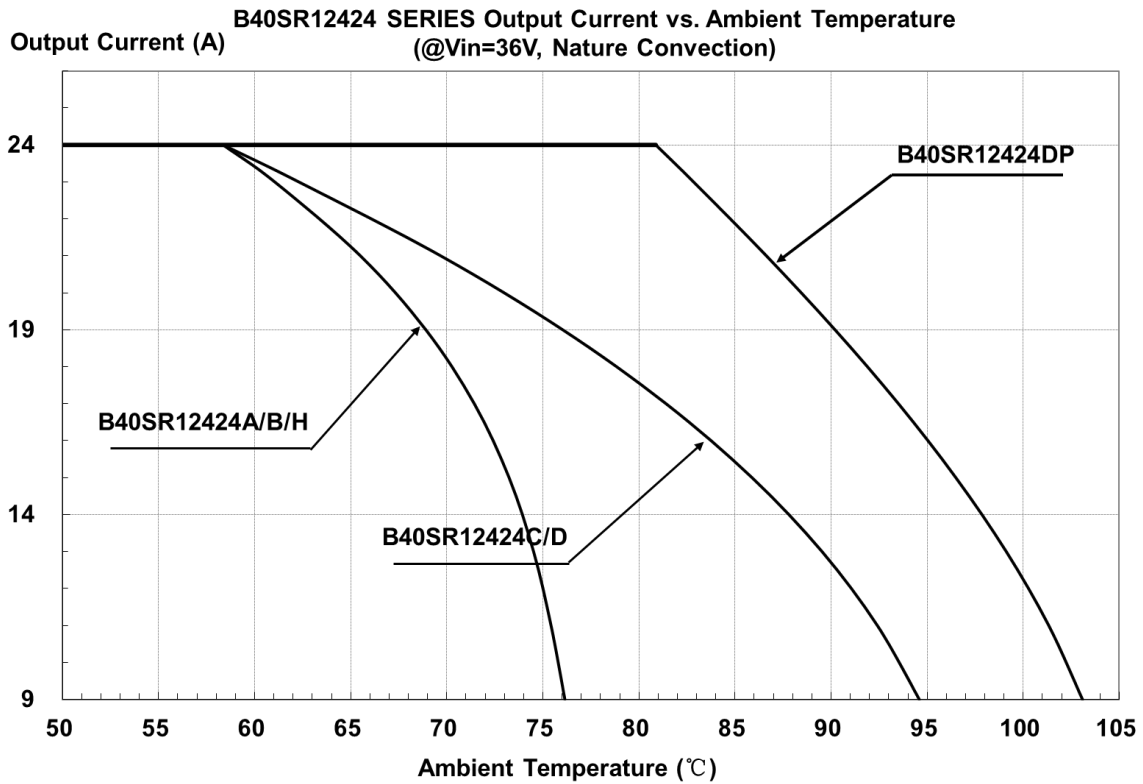

Figure 22: Output Current vs. Ambient temperature @ Vin=36V

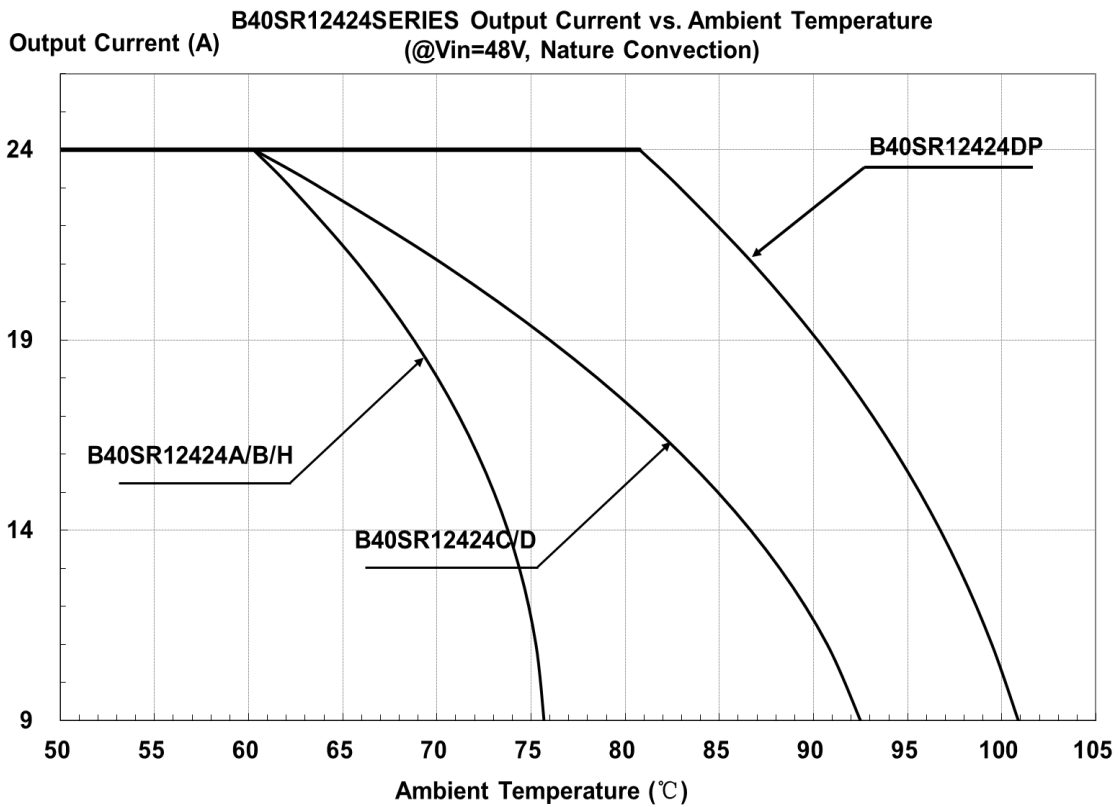
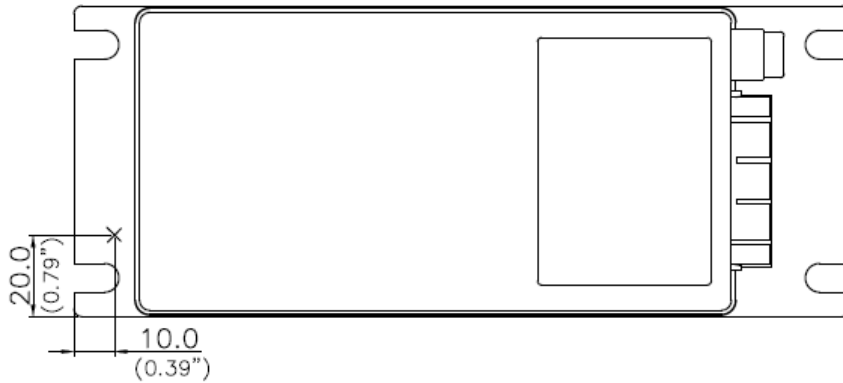

Figure 23: Output Current vs. Ambient temperature @ Vin=48V

## THERMAL CONSIDERATION

The following figure shows the location to monitor the temperature of base plate. Before customer decides to use this DCDC converter, a thermal evaluation need to be did to make sure the temperature of base plate is lower than that read from below thermal curves (Figure25~27 base on different input voltage).



**Figure 24:** Thermal consideration

## THERMAL CURVE

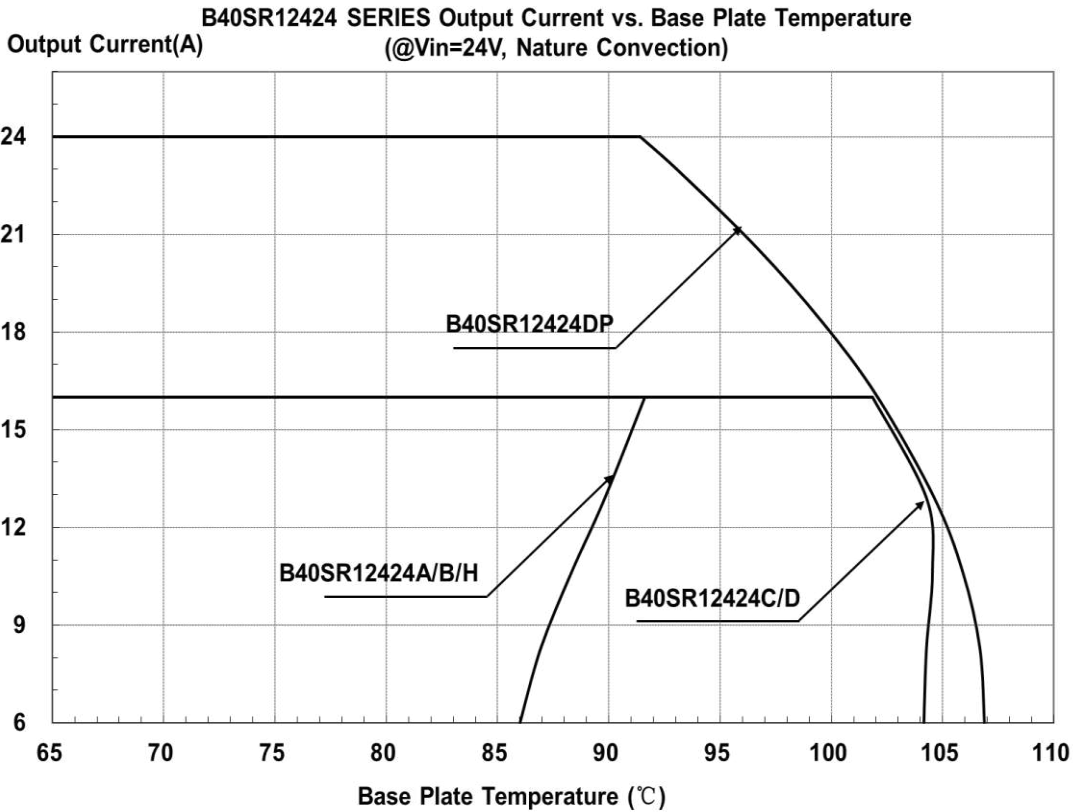

**Figure 25:** Output Current vs. Base Plate temperature @Vin=24V

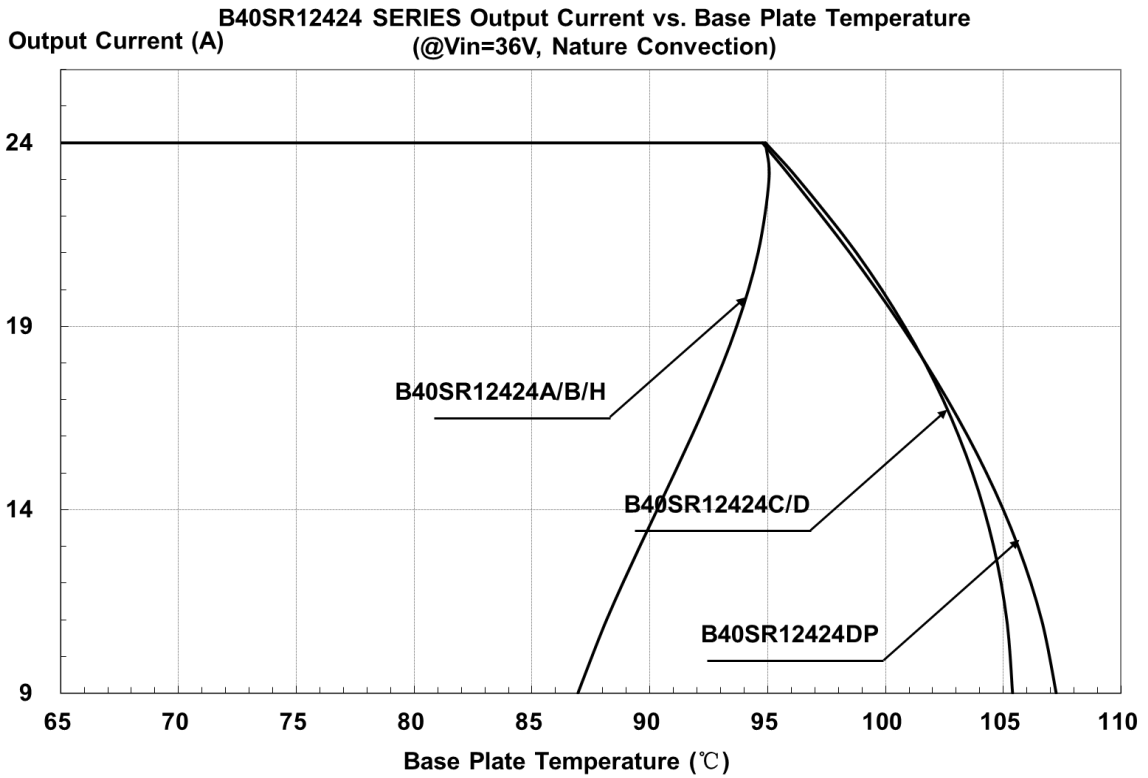

Figure 26: Output Current vs. Base Table temperature @ Vin=36V

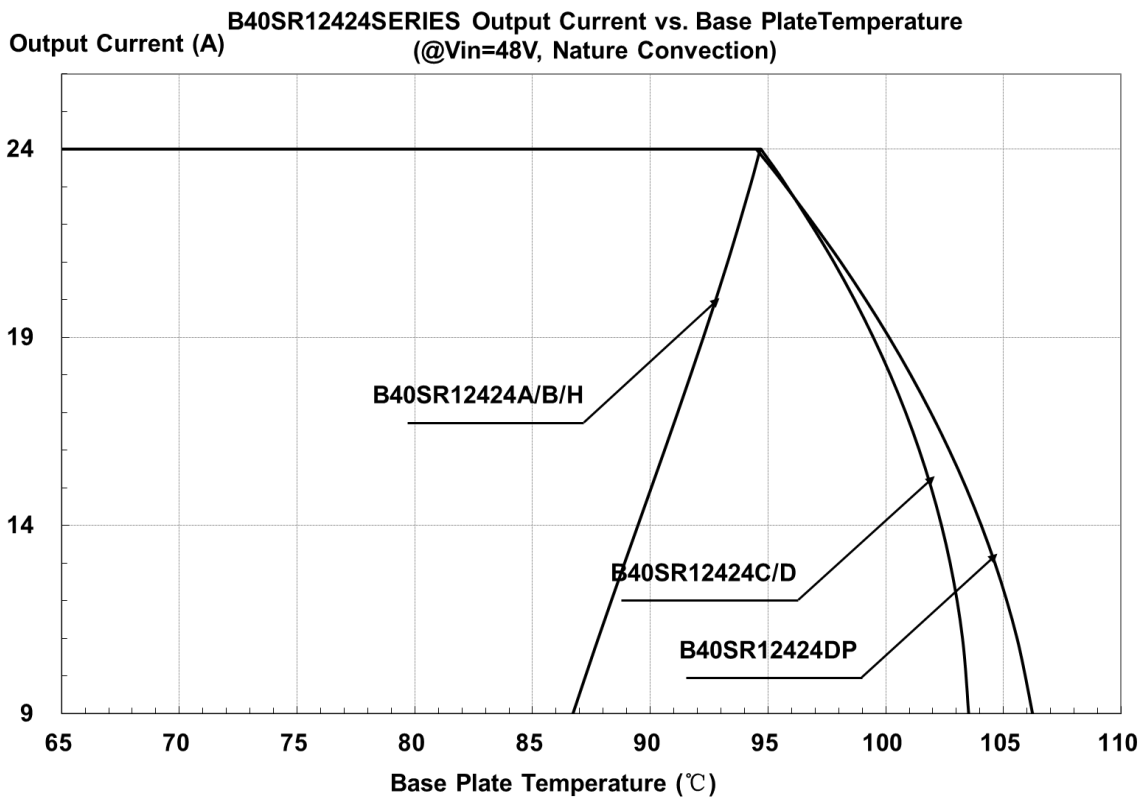
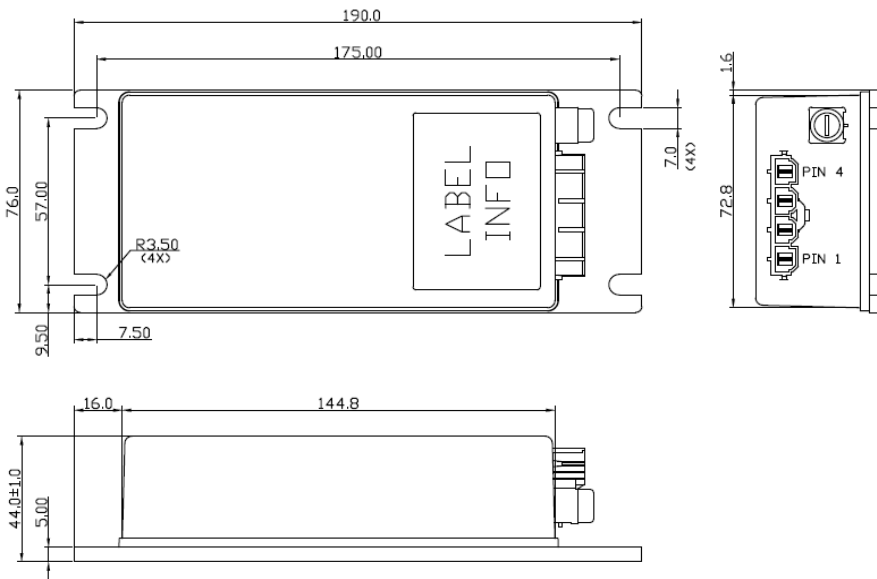

Figure 27: Output Current vs. Base Table temperature @ Vin=48V

## Mechanical Drawing

### Mechanical Dimensions



B40SR12424A

### Pin Connections

Pin	Function Description
1	OUTPUT -
2	OUTPUT +
3	INPUT -
4	INPUT +

- All dimensions in mm (inches)
- Tolerance: X.X±0.5 (X.XX±0.02)  
X.XX±0.25 ( X.XXX±0.010)
- Connector:  
MOLEX MINI-FIT Sr™ Header  
(MOLEX P/N :42819-4213)

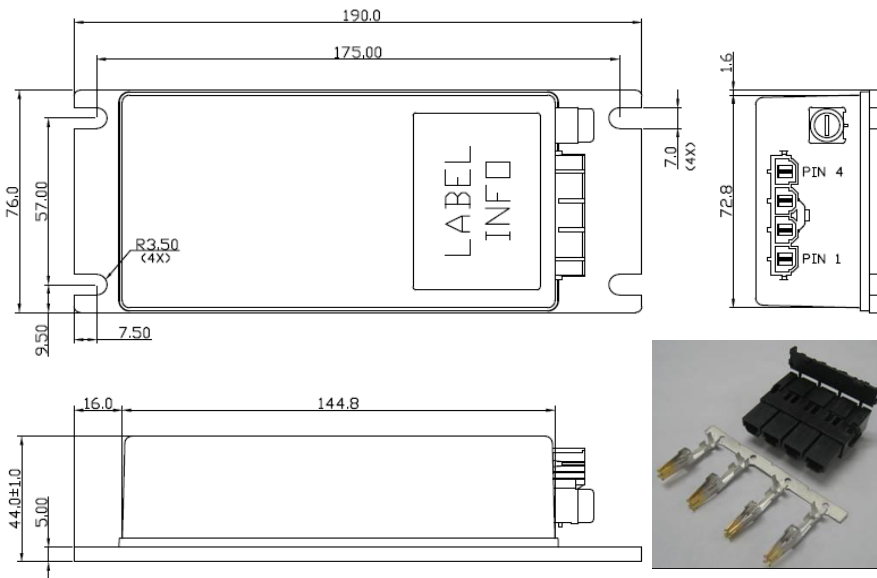

B40SR12424AC

Pin	Function Description
1	OUTPUT -
2	OUTPUT +
3	INPUT -
4	INPUT +

- All dimensions in mm (inches)
- Tolerance: X.X±0.5 (X.XX±0.02)  
X.XX±0.25 ( X.XXX±0.010)
- Connector:  
MOLEX MINI-FIT Sr™ Header  
(MOLEX P/N :42819-4213)
- Connector kit :  
Housing: 42816-0412  
Terminal: 42815-0042

## Mechanical Drawing

### Mechanical Dimensions

### Pin Connections

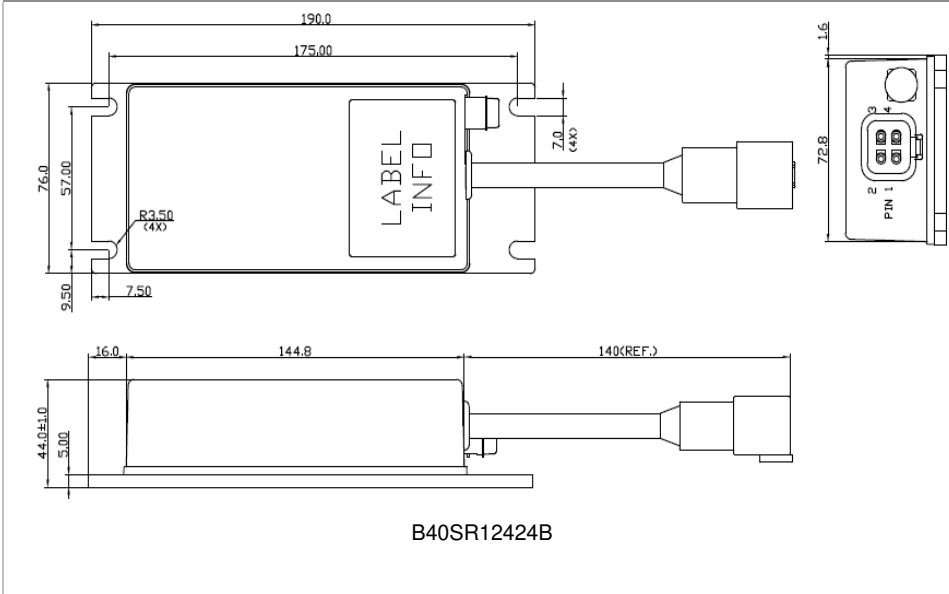

Pin	Function Description
1	OUTPUT -
2	OUTPUT +
3	INPUT -
4	INPUT +

- All dimensions in mm (inches)
- Tolerance: X.X±0.5 (X.XX±0.02)  
X.XX±0.25 ( X.XXX±0.010)
- Connector:  
Deutsch DTP Receptacles  
(DEUTSCH P/N :DTP04-4P)

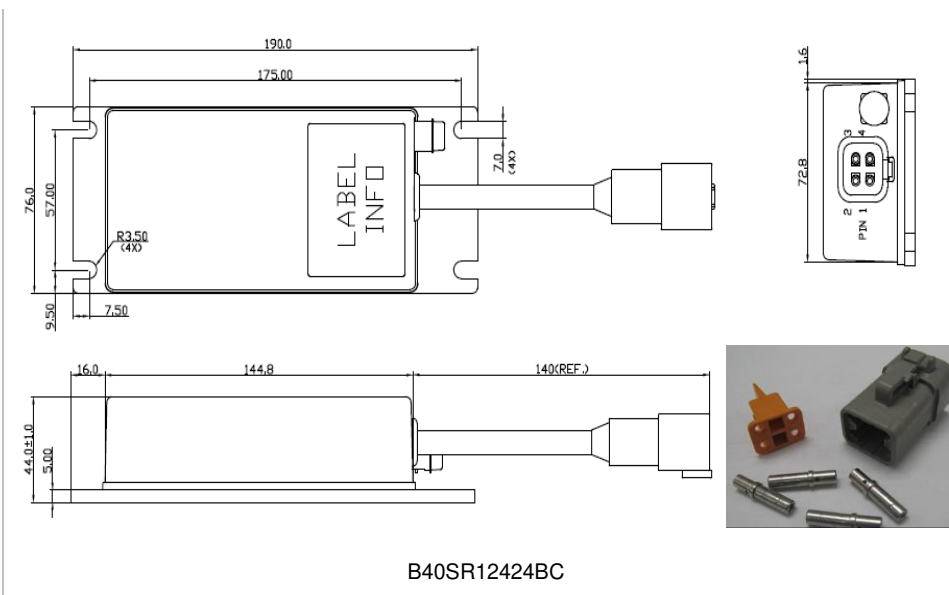

Pin	Function Description
1	OUTPUT -
2	OUTPUT +
3	INPUT -
4	INPUT +

- All dimensions in mm (inches)
- Tolerance: X.X±0.5 (X.XX±0.02)  
X.XX±0.25 ( X.XXX±0.010)
- Connector:  
Deutsch DTP Receptacles  
(DEUTSCH P/N :DTP04-4P)
- Connector kit :  
Housing: DTP06-4S  
Wedge lock: WP-4S  
Terminal: 0462-203-12141

## Mechanical Drawing

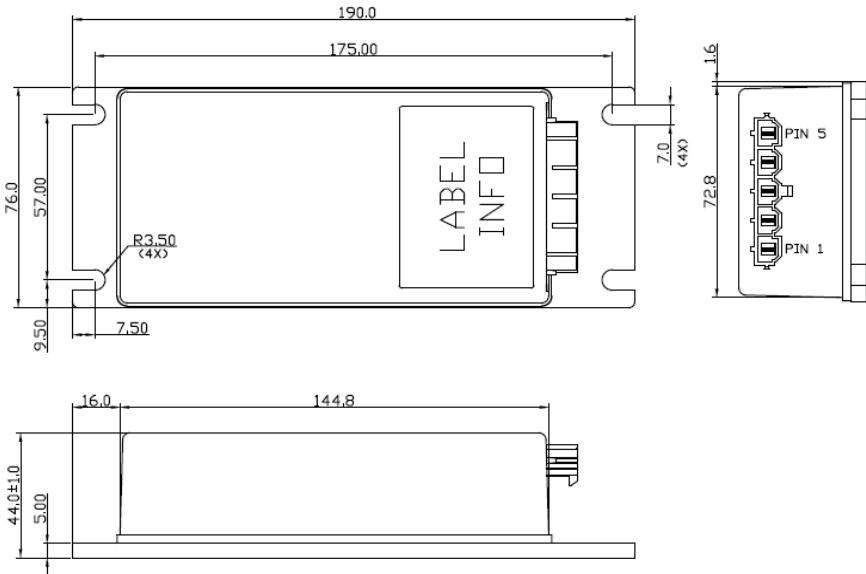
Mechanical Dimensions		Pin Connections	
		Pin	Function Description
		1	OUTPUT -
<p style="text-align: center;">LABEL INFO</p>		2	OUTPUT +
		3	INPUT -
		4	INPUT +
		5	ENABLE
		<p>➤ All dimensions in mm (inches)</p> <p>➤ Tolerance: X.X±0.5 (X.XX±0.02) X.XX±0.25 ( X.XXX±0.010)</p> <p>➤ Connector: MOLEX MINI-FIT Sr™ Header (MOLEX P/N :42819-5213)</p>	
B40SR12424C			

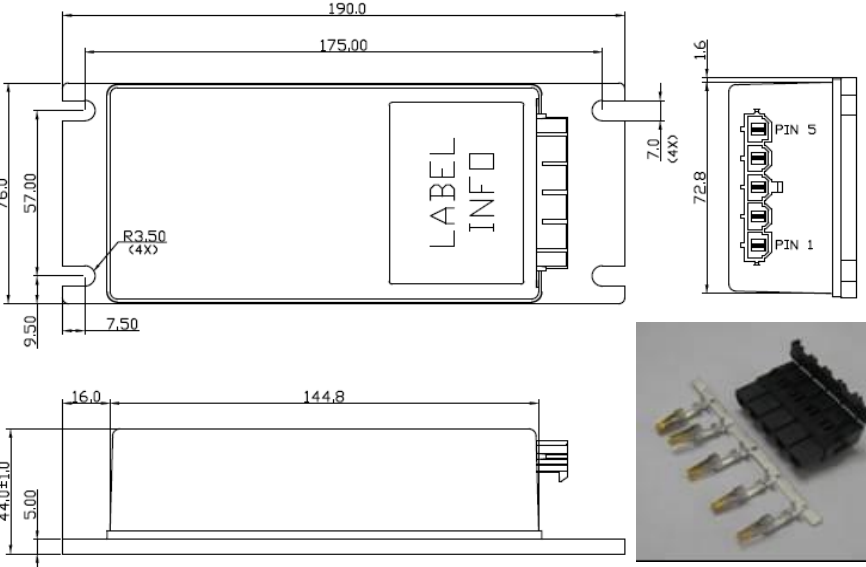
		Pin	Function Description
		1	OUTPUT -
<p style="text-align: center;">LABEL INFO</p>		2	OUTPUT +
		3	INPUT -
		4	INPUT +
		5	ENABLE
		<p>➤ All dimensions in mm (inches)</p> <p>➤ Tolerance: X.X±0.5 (X.XX±0.02) X.XX±0.25 ( X.XXX±0.010)</p> <p>➤ Connector: MOLEX MINI-FIT Sr™ Header (MOLEX P/N :42819-5213)</p> <p>➤ Connector kit : Housing: 42816-0512 Terminal: 42815-0042</p>	
B40SR12424CC			

## Mechanical Drawing

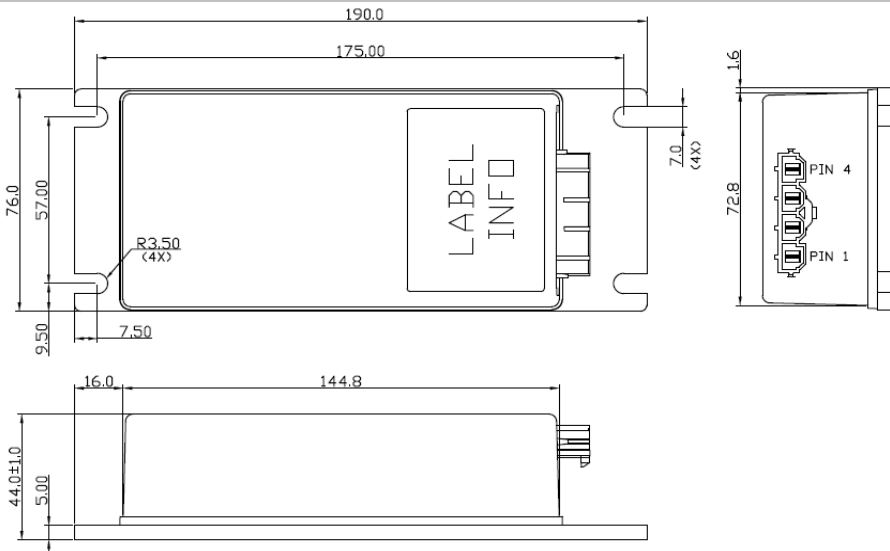
Mechanical Dimensions		Pin Connections	
 <p>Top view dimensions: 190.0 (total width), 175.0 (inner width), 76.0 (total height), 57.0 (inner height), R3.50 (4X) (corner radius), 9.50 (left offset), 7.50 (right offset), 7.0 (4X) (pin height).</p> <p>Side view dimensions: 144.8 (length), 44.0±1.0 (height), 5.00 (bottom offset), 16.0 (top offset).</p> <p>Connector view dimensions: 72.8 (width), 1.6 (height).</p> <p>Pin labels: PIN 4, PIN 1.</p>		Pin	Function Description
		1	OUTPUT -
		2	OUTPUT +
		3	INPUT -
4	INPUT +		
		<ul style="list-style-type: none"> <li>➤ All dimensions in mm (inches)</li> <li>➤ Tolerance: X.X±0.5 (X.XX±0.02) X.XX±0.25 (X.XXX±0.010)</li> <li>➤ Connector: MOLEX MINI-FIT Sr™ Header (MOLEX P/N :42819-4213)</li> </ul>	
B40SR12424D\DP			

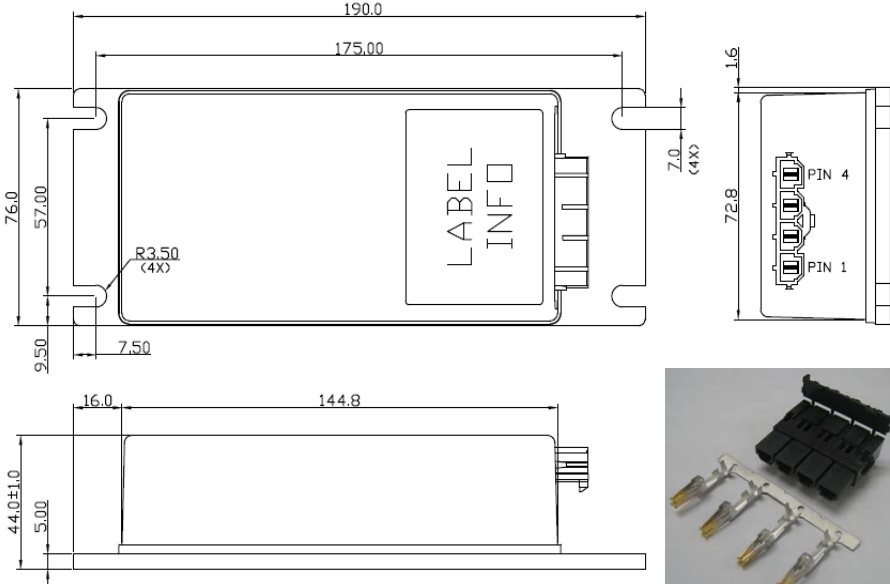
 <p>Top view dimensions: 190.0 (total width), 175.0 (inner width), 76.0 (total height), 57.0 (inner height), R3.50 (4X) (corner radius), 9.50 (left offset), 7.50 (right offset), 7.0 (4X) (pin height).</p> <p>Side view dimensions: 144.8 (length), 44.0±1.0 (height), 5.00 (bottom offset), 16.0 (top offset).</p> <p>Connector view dimensions: 72.8 (width), 1.6 (height).</p> <p>Pin labels: PIN 4, PIN 1.</p>		Pin	Function Description
		1	OUTPUT -
		2	OUTPUT +
		3	INPUT -
4	INPUT +		
		<ul style="list-style-type: none"> <li>➤ All dimensions in mm (inches)</li> <li>➤ Tolerance: X.X±0.5 (X.XX±0.02) X.XX±0.25 (X.XXX±0.010)</li> <li>➤ Connector: MOLEX MINI-FIT Sr™ Header (MOLEX P/N :42819-4213)</li> <li>➤ Connector kit : Housing: 42816-0412 Terminal: 42815-0042</li> </ul>	
B40SR12424DC\DPC			

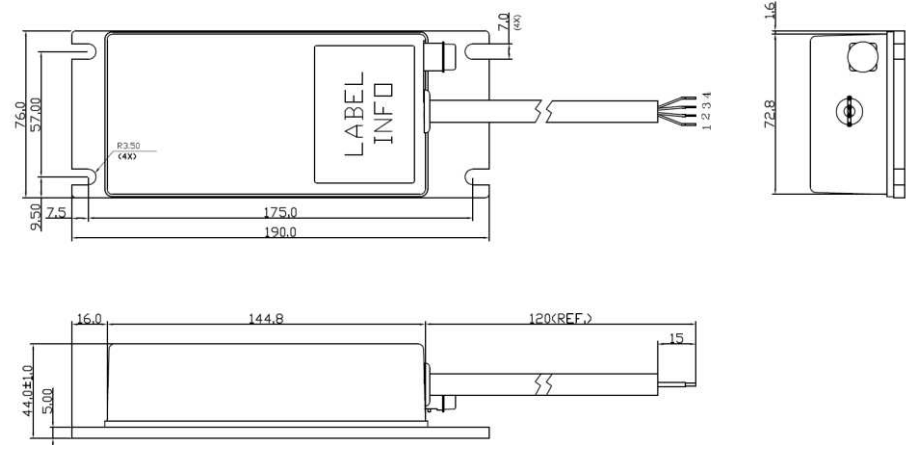

## Mechanical Drawing

Mechanical Dimensions		Pin Connections	
B40SR12424H SERIES		Pin	Function / Wire Color
		1	OUTPUT -, YELLOW
		2	OUTPUT +, BLUE
		3	INPUT -, BLACK
		4	INPUT +, RED
		<ul style="list-style-type: none"> <li>➤ All dimensions in mm (inches)</li> <li>➤ Tolerance: X.X±0.5 (X.XX±0.02) X.XX±0.25 ( X.XXX±0.010)</li> </ul>	
B40SR12424H			

## Physical Outline

Case Size	: 190.0x76.0x44.0 mm (7.48"x2.99"x1.73")
Case Material	: Case: PC; Plate: AL6063



## Part Numbering System

B	40	S	R	124	24	A			C	
Form Factor	Input Voltage	Number of Outputs	Product Series	Output Voltage	Output Current	Option Code			Option Fitting	
B-Box	40 – 18V~60V	S – Single	R – Regular	124 – 12.4V	24 – 24A		With Built-in fuse holder	Enable pin	Sealed connector & fuse holder	Connector Kit
						A	YES	NO	NO	1xhousing+ 4 terminals
						B	YES	NO	YES	1xhousing+ 4 terminals
						C	NO	YES	NO	1xhousing+ 5 terminals
						D	NO	NO	NO	1xhousing+ 4 terminals
						DP	NO	NO	NO	1xhousing+ 4 terminals
						H	YES	NO	NO	N/A

## Model List

Input Voltage Range	Input		Output		EFF @48VIN 100% LOAD
B40SR12424(A\B\C\D\H)	18V~60V	13.1A	12.4V	24A	88.3%
B40SR12424(DP)	18V~60V	19.5A	12.4V	24A	88.3%

**CONTACT:** [www.deltaww.com/dcdc](http://www.deltaww.com/dcdc)

**Email:** [dcdc@deltaww.com](mailto:dcdc@deltaww.com)

**USA:**

Telephone:  
East Coast: 978-656-3993  
West Coast: 510-668-5100  
Fax: (978) 656 3964

**Europe:**

Phone: +31-20-655-0967  
Fax: +31-20-655-0999

**Asia & the rest of world:**

Telephone: +886 3 4526107  
ext 6220~6224  
Fax: +886 3 4513485

**WARRANTY**

Delta offers a two (2) years limited warranty. Complete warranty information is listed on our web site or is available upon request from Delta.

Information furnished by Delta is believed to be accurate and reliable. However, no responsibility is assumed by Delta for its use, nor for any infringements of patents or other rights of third parties, which may result from its use. No license is granted by implication or otherwise under any patent or patent rights of Delta. Delta reserves the right to revise these specifications at any time, without notice.