



Chipsmall Limited consists of a professional team with an average of over 10 year of expertise in the distribution of electronic components. Based in Hongkong, we have already established firm and mutual-benefit business relationships with customers from,Europe,America and south Asia,supplying obsolete and hard-to-find components to meet their specific needs.

With the principle of "Quality Parts,Customers Priority,Honest Operation,and Considerate Service",our business mainly focus on the distribution of electronic components. Line cards we deal with include Microchip,ALPS,ROHM,Xilinx,Pulse,ON,Everlight and Freescale. Main products comprise IC,Modules,Potentiometer,IC Socket,Relay,Connector.Our parts cover such applications as commercial,industrial, and automotives areas.

We are looking forward to setting up business relationship with you and hope to provide you with the best service and solution. Let us make a better world for our industry!



## Contact us

Tel: +86-755-8981 8866 Fax: +86-755-8427 6832

Email & Skype: info@chipsmall.com Web: www.chipsmall.com

Address: A1208, Overseas Decoration Building, #122 Zhenhua RD., Futian, Shenzhen, China



### FEATURES

- Wide input voltage range, 36~106V
- 300W Output
- Full Load Efficiency up to 89.5% @48Vin; 90%@72Vin
- Intergrated fuse holder (option)
- Parallel Connection of multiple units
- Box type package with metal base plate
- Package Dimension: 190.0x76.0x44.0 mm (7.48"x2.99"x1.73")
- Operating Temperature Range - 40°C to +75°C
- Input Reverse Polarity Protection
- Minimized Inrush current
- Input UVLO, Output OCL, Short circuit protection, OVP, OTP
- Enable on/off (option)
- 2250VDC Isolation
- IP67 protection for selective model
- RoHs Compliant
- ISO 9001, ISO 14001 certified manufacturing facility
- UL60950
- CE Mark
- EMC compatible: EN12895, CISPR11 ClassA
- Electrical transient conduction: ISO7637-2



The B70SR12424, a wide input voltage range of 36~106V, and single isolated output converter, is the latest product offering from a world leader in power systems technology and manufacturing — Delta Electronics, Inc. Such box type DCDC converter can provide 300W, 12.4V regulated DC output voltage with full load efficiency up to 90% @72Vin; The B70SR12424 offers input UVLO, output over current limit, short circuit, output over voltage, over temperature, and input reverse polarity protections, It has an option for intergrated fuse holder and enable on/off function. It also has parallel function; and allows a wide operating temperature range of -40°C to +75°C. With creative design technology and optimization of component placement, this converter possess outstanding electrical and thermal performance, as well as high reliability under extrmely harsh operating conditions. The B70SR12424 meets IP67 protection (refer to “water protection level” specification).

### Input Characteristics

Item	Condition	Min.	Typ.	Max.	Unit
Continuous Input Voltage		36	72	106	VDC
Max Input voltage	10 minutes, normal operating			126	VDC
Input Under-Voltage Lockout, Turn-On Voltage Threshold		33	34	35	VDC
Input Under-Voltage Lockout, Turn-Off Voltage Threshold		31	32	33	VDC
Lockout Hysteresis Voltage		1	2	3	VDC
Maximum Input Current	Vin=36V, 100% Load		9.2	10	A
No-Load Input Current	Vin=48V		35	60	mA
	Vin=72V, 80V		25	50	mA
Off converter input current	Vin=72V, enable off (C version)		7	12	mA
Reflected input ripple current	Vin=72V, Vpp			0.2	A
Max Reverse Polarity Input Voltage				106	VDC
Max Inrush current				10	A
Internal Input Fuse	Ø6.35mm*31.75mm	250V/25A Fast-acting fuse			



## Output Characteristics

Item	Conditions	Min.	Typ.	Max.	Unit
Operating Output Current Range		0		24	A
Output Voltage Set Point	Io=0	12.4	12.6	12.8	V
	Io=24A	12.0	12.2	12.4	V
Output Voltage Ripple and Noise,	Vin=48V, Io=24A, peak to peak, 20MHz bandwidth		100	150	mV
	RMS		30	50	mV
	Vin=72V, 80V, Io=24A, peak to peak, 20MHz bandwidth		150	200	mV
	RMS		50	80	mV
Output Current Limit		25	28	31	A
Current share accuracy	24A for each module		6	10	%
Start-up time(start _up time by Vin)	Vin=48V,full load (for A/B/C/D)		500	600	mS
Start-up time(start _up time by Enable)	Vin=48V,full load (for C)		250	350	mS
Rise time			30	50	mS
Output Voltage Protection		13	15	17	V
Output Voltage Current Transient	Positive voltage step, 18A to 12A load dynamic, 0.1A/us slew rate		150	250	mV
	Negative voltage step, 12A to 18A load dynamic, 0.1A/us slew rate		150	250	mV
Maximum Output Capacitance	ESR>10mohm			5000	μF
Output overshoot				3	%
Efficiency @ 100% Load	Vin=48V	87.5	89.5		%
Efficiency @ 100% Load	Vin=72V	88.0	90.0		%
Efficiency @ 100% Load	Vin=80V	88.0	90.0		%
Efficiency @ 60% Load	Vin=48V	88.0	90.0		%
Efficiency @ 60% Load	Vin=72V	88.3	90.3		%
Efficiency @ 60% Load	Vin=80V	88.3	90.3		%

## General Characteristics

Item	Conditions	Min.	Typ.	Max.	Unit
Isolation Voltage,	Input to Output, Input to Case			2250	VDC
	Output to Case			550	VDC
Isolation Resistance, Input to Output		10			MΩ
Isolation Capacitance, Input to Output			5000		pF
Switching Frequency			175		KHz
MTBF	Ta=25°C, 80%load		1.08		Mhours
Weight			900		g

## Environmental Specifications

Parameter	Conditions	Min.	Typ.	Max.	Unit
Storage Temperature Range		-40		+125	°C
Operating Temperature Range	Ambient Temperature	-40		+75	°C
Over Temperature Protection	NTC Temperature		122		°C
Humidity (non condensing)				95	% rel. H
Water Protection Level	For model P/N with suffix B	IP67			
Vibration	IEC 60068-2-6	10G/15~200HZ/3 PLANES			
Shock	IEC 60068-2-27	50G 3 PLANES			
Emission	EN12895	30-1000MHz 34-45dBuV/m			
Immunity	EN12895, EN61000-4-3	10V/m /27-1000MHz AM; 10V/m /900MHz PM			
ESD	EN12895, EN61000-4-2	Direct: ±2KV ±4KV; Air: ±2KV ±4KV ±8KV			

## Notes

- Specifications typical at Ta=+25°C, nominal input voltage and rated full load output current unless otherwise noted.
- Specifications are subject to change without notice.

## ELECTRICAL CURVES

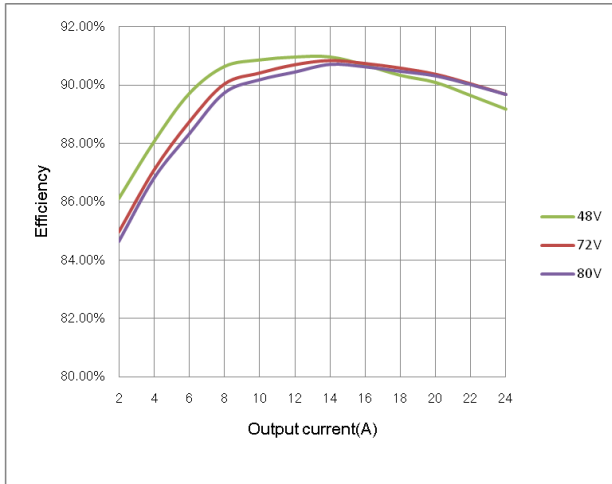

**Figure 1: Efficiency vs. Output current**  
@ Vin=48V,72V,80V

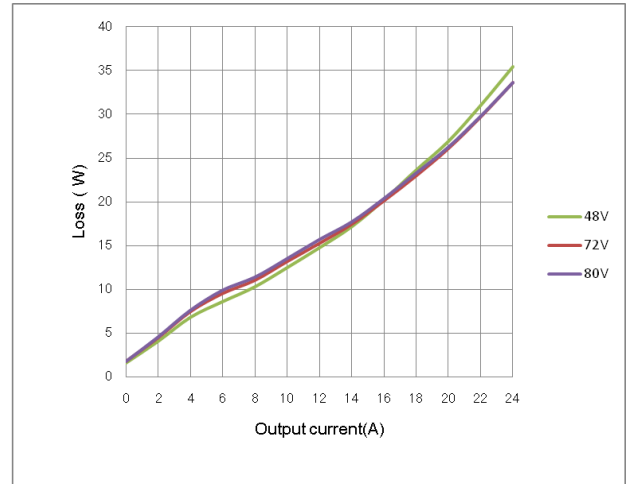

**Figure 2: Loss vs. Output current**  
@ Vin=48V,72V,80V

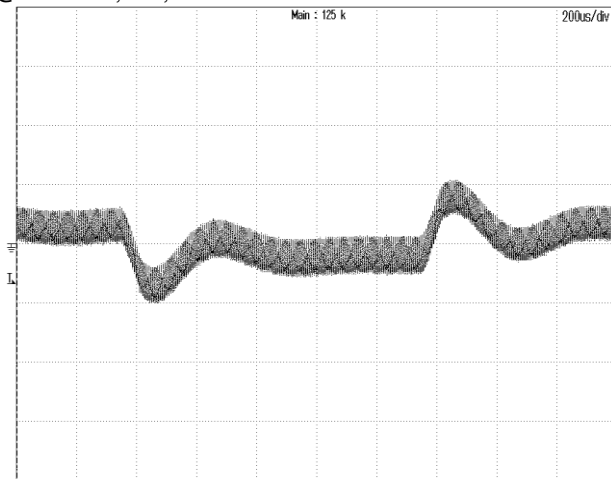

**Figure 3: Dynamic response to load step 12A~18A with 0.1A/uS slew rate at 72Vin**  
CH1:VOUT, 200mV/div, 200uS/div

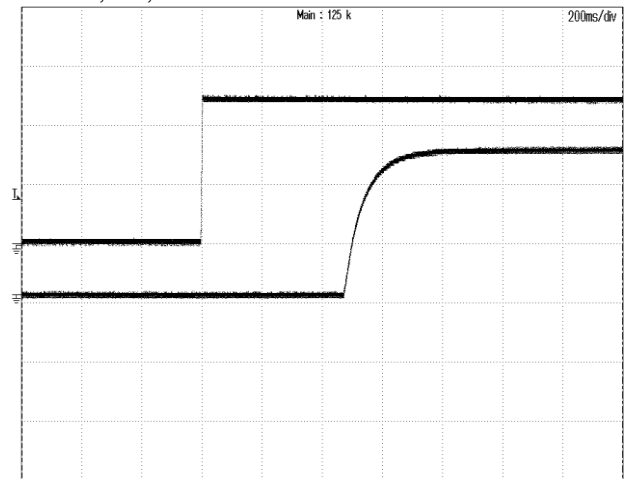

**Figure 4: Vout start up with Vin on at 72Vin,24A Iout,**  
TOP:VIN, 20V/div, 200mS/div  
BOTTOM: VOUT, 5V/div, 200mS/div

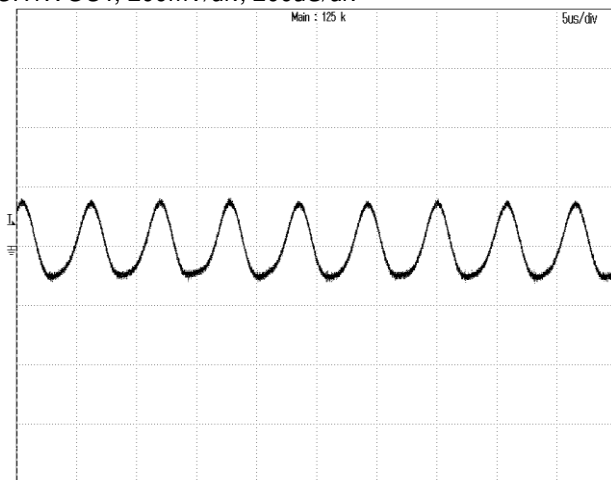
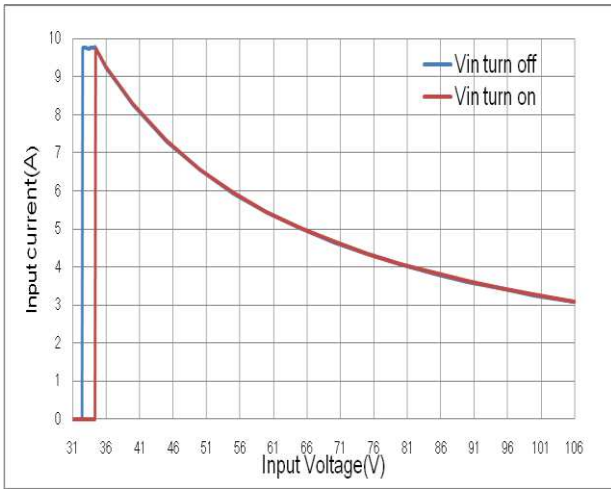

**Figure 5: Output ripple & noise at 72Vin, 24A Iout**  
CH1:VOUT, 100mV/div, 5uS/div

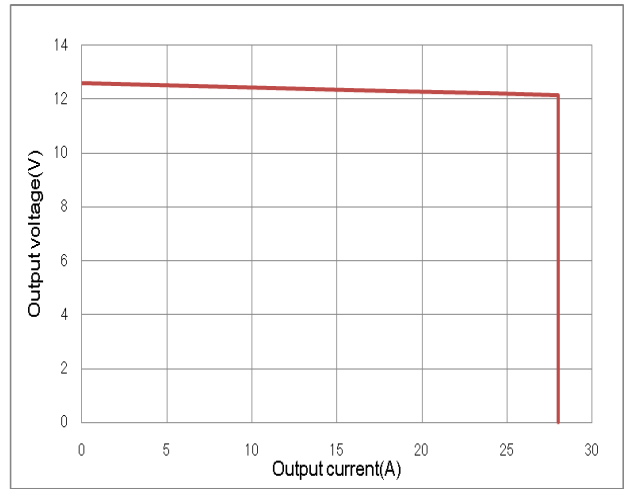

**Figure 6: Output over voltage protection at 72Vin, 24A Iout**  
CH1:VOUT, 10V/div, 50mS/div

## ELECTRICAL CURVES (continuous)



**Figure 7:** Input current vs. Input voltage @ Full load



**Figure 8:** Output voltage vs. Output current OCL Performance

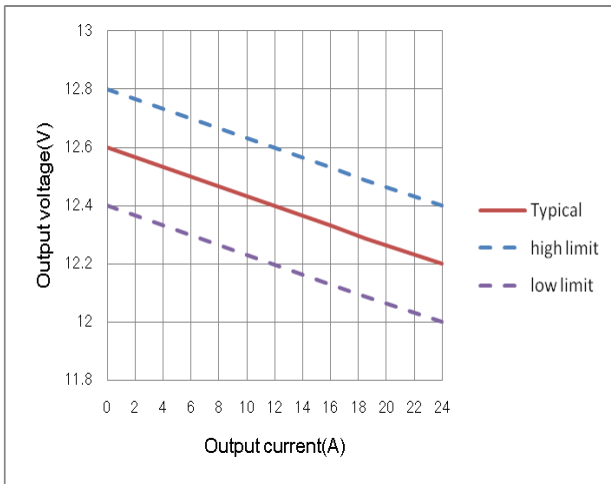

**Figure 9:** Output voltage vs. Output current @ Vin=72V. Droop function.

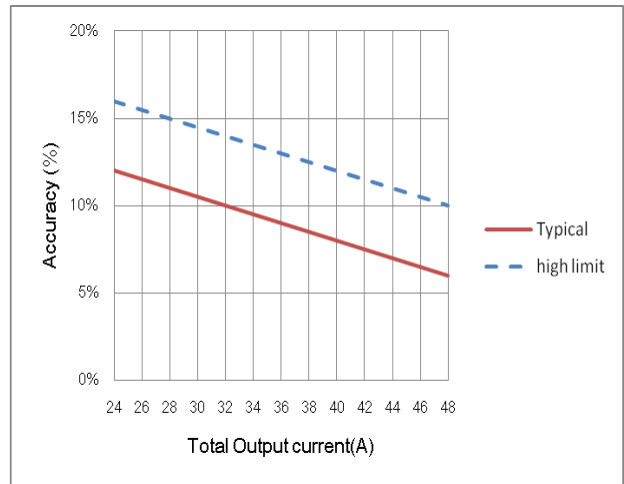

**Figure 10:** Current share accuracy vs. Total output current 2 in parallel.

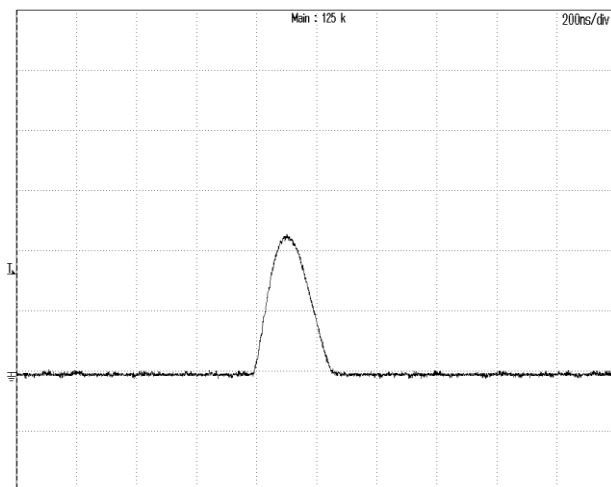

**Figure 11:** Inrush current @ Vin=72V  
CH1:lin, 2A/div, 200ns/div; Max current 4.3A,  $I_2t=1.5E-7$  A<sup>2</sup>S

## FEATURES DESCRIPTIONS

### Output Over-Current Limit and Short Protection

The modules include internal output over-current limit (OCL) and short circuit protection (SCP) circuits, the OCL set point is lower than that of the SCP; The response of SCP circuit is much fast than that of the OCL circuit. The slowly increase of the output current will let module enter OCL protection when the current exceeds the OCL set point, while the fast increase of the output current will let module enter SCP when the current exceeds the SCP set point.

When the modules enter OCL protection, the output voltage will decrease while the output current is kept constant, the output voltage will soft start to set point when the overload condition is removed.

The module will enter hiccup mode when it triggers the SCP set point. The module will try to restart after shutdown. If the overload condition still exists, the module will shut down again. This restart trial will continue until the overload condition is removed.

### Output Over-Voltage Protection

The power module includes an internal output over-voltage protection(OVP) circuit, which monitors the voltage on the output terminals. If this voltage exceeds the OVP set point, the module will shut down, and then restart after a fixed delay time (hiccup mode), please refer to figure6 for detail.

### Over-Temperature Protection

The over-temperature protection consists of circuitry that provides protection from thermal damage. If the temperature exceeds the preset temperature threshold the module will shut down, and all components will not exceed their absolute maximum temperature ratings. The module will restart after the temperature is within specification.

### Remote On/Off

B70SR12424C has Enable control function. This Enable PIN is designed on the primary side of converter, the converter will turn on when the Enable PIN connected to VIN+, and turn off when the Enable PIN connected to VIN- or floating..

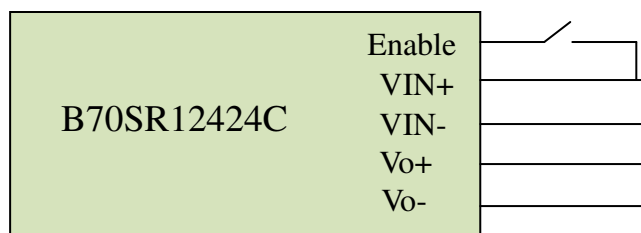

*Figure 12: suggested Enable connection*

### Input Reverse Voltage Protection

The input reverse voltage protection is provided by an diode on the input line, the standoff voltage for the reverse protection shall be no less than -106V.

## DESIGN CONSIDERATIONS

### Parallel connection of multiple units

Two units parallel operation is verified, please contact Delta if more than two units need to be paralleled. While paralleling multiple units, the impedance of the cables from unit to junction point of each unit should be within  $\pm 5\%$  of each other.

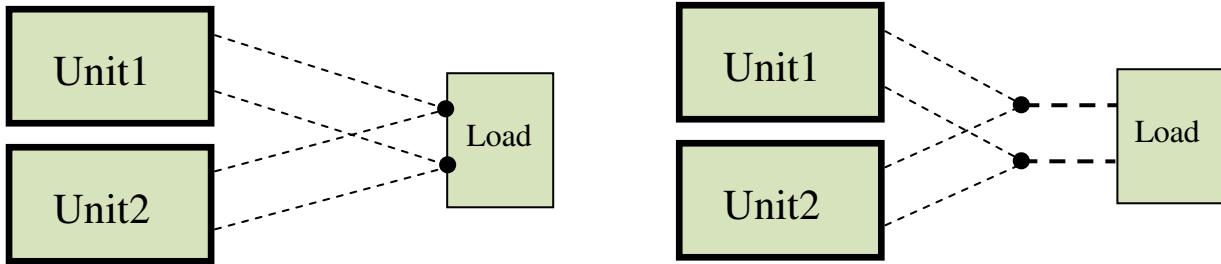

Figure 13: suggested parallel connections

### EMC

The converter has the internal EMI filters and meet the EMC standards EN12895 30-1000MHz 34-45dBuV/m. The test result is showed as below

**Conditions:** Vin=72V, Io=24A, 10m measure distance

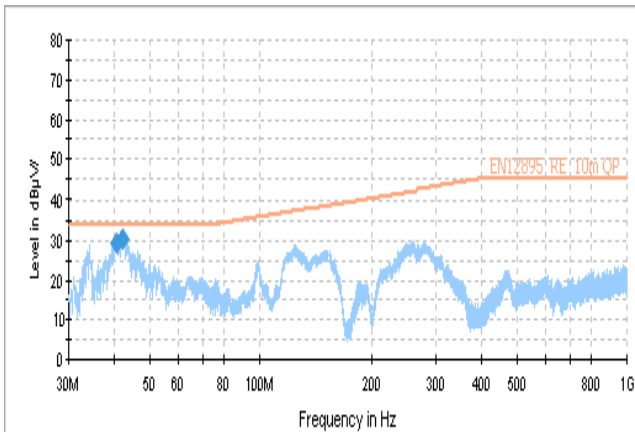

Figure 14: test result(Vertical)

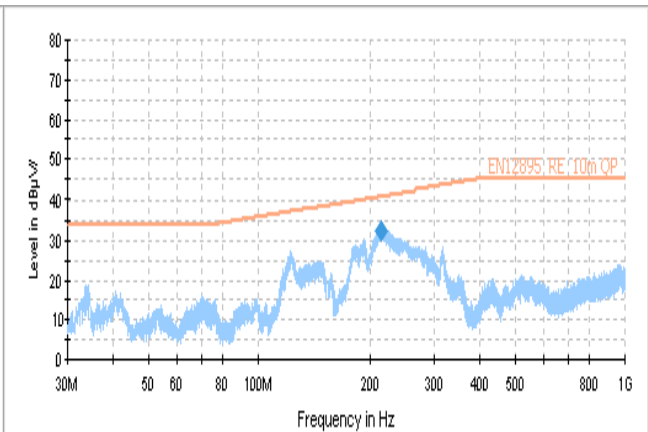

Figure 15: test result(Horizontal)

### Fuse replacement

For the versions with the intergrated the fuse holder, when the fuse needs to be replaced, it can be taken down in an anticlockwise direction by slotted type screwdrivers .

Recommended fuse replacement P/N:

Littlefuse 0314025.MXP

## THERMAL CONSIDERATION

The thermal curve (Figure17~19) is based on a 250x300x5 AL table, shown as below figure.

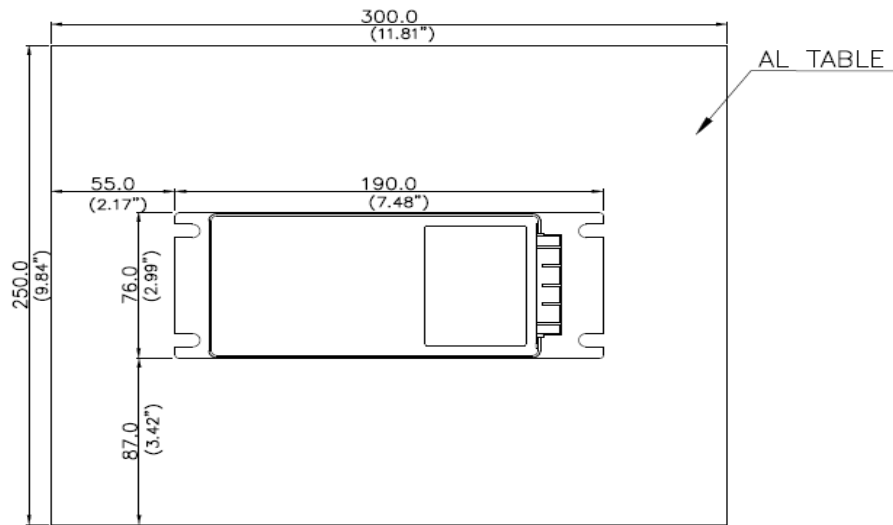

Figure 16: Thermal consideration

## THERMAL CURVE

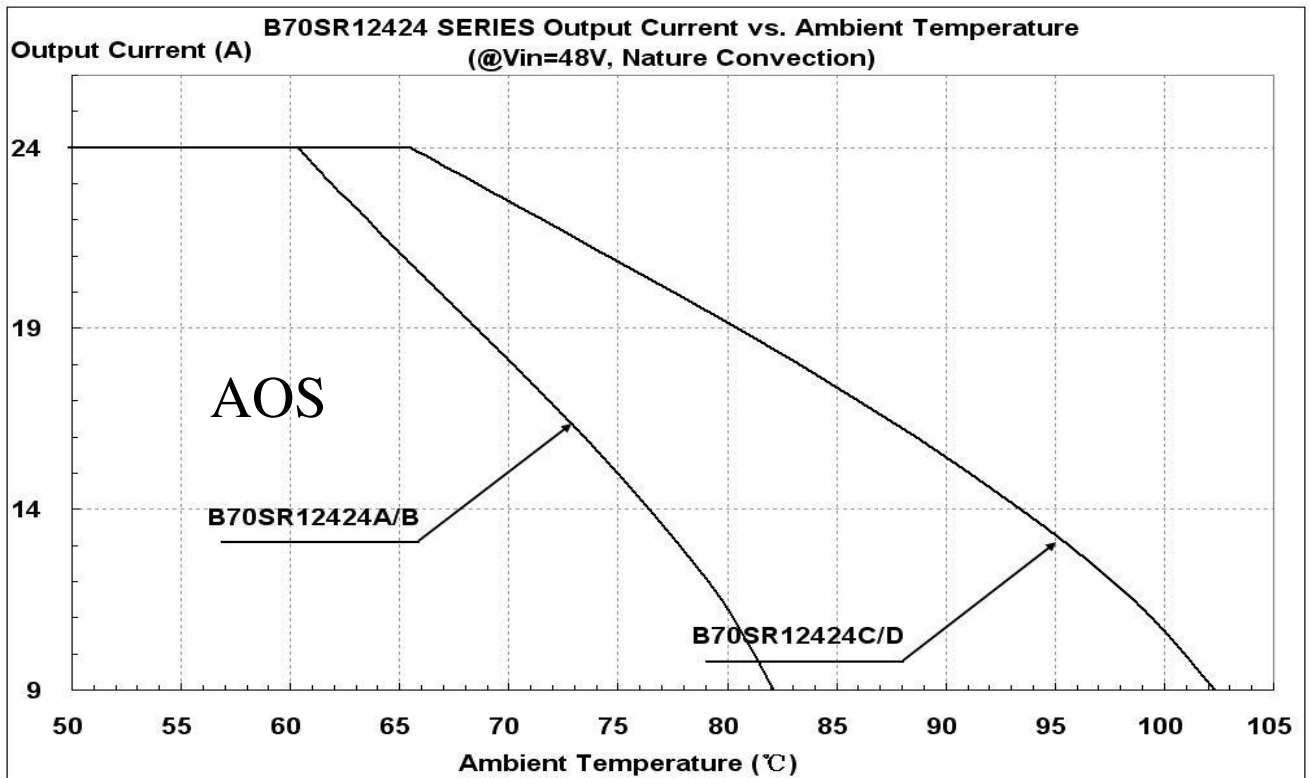

Figure 17: Output Current vs. ambient temperature @Vin=48V



**THERMAL CURVES**

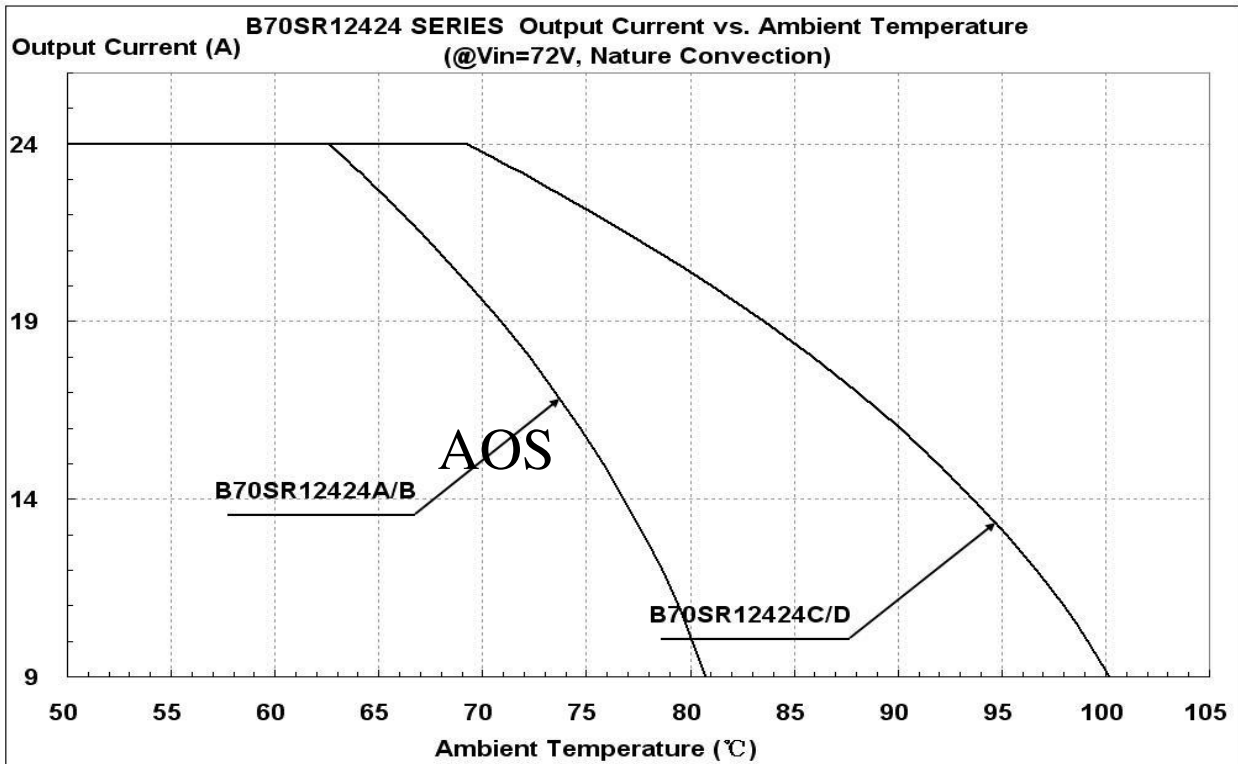

Figure 18: Output Current vs. ambient temperature @Vin=72V

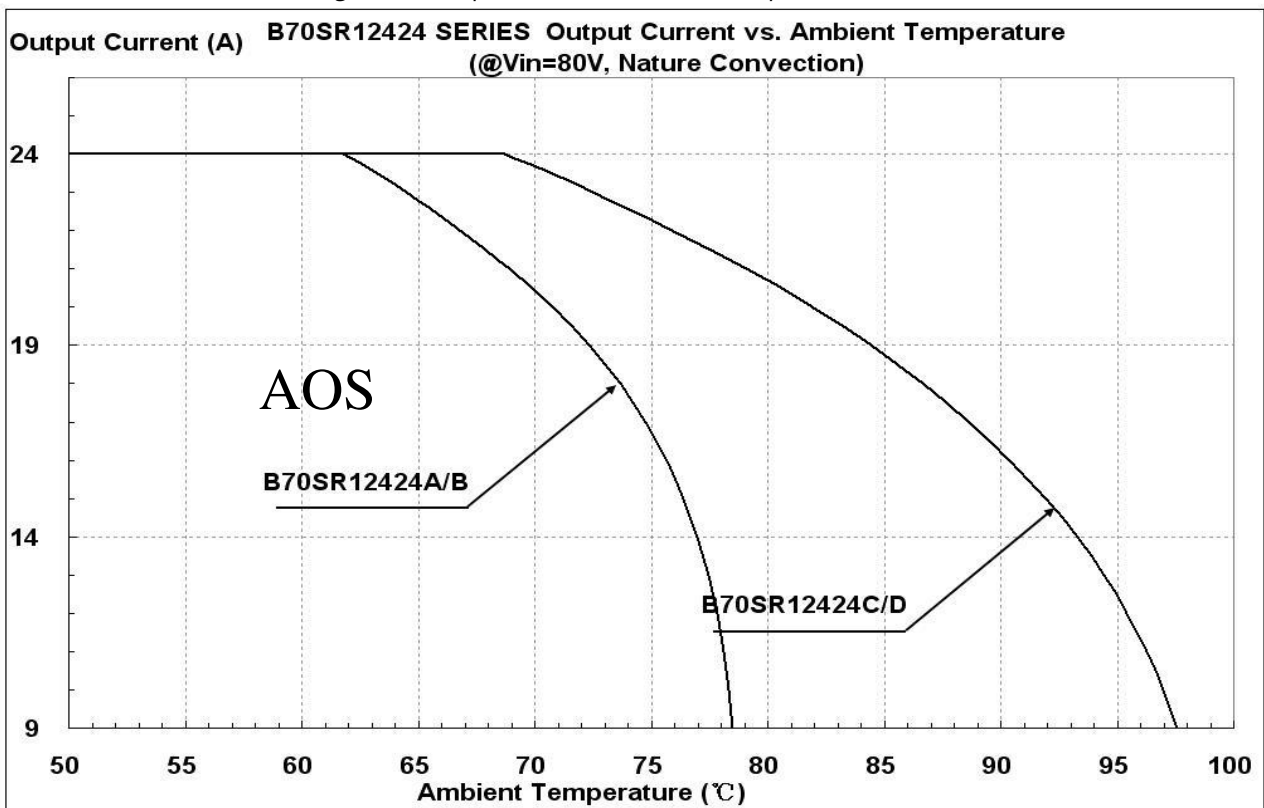

Figure 19: Output Current vs. ambient temperature @Vin=80V

## THERMAL CONSIDERATION

The following figure shows the location to monitor the temperature of base plate. Before customer decides to use this DCDC converter, a thermal evaluation need to be did to make sure the temperature of base plate is lower than that read from below thermal curves (Figure21~23 base on different input voltage).

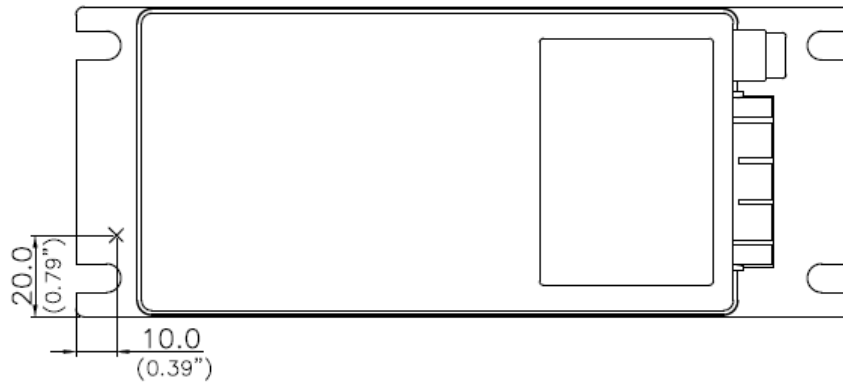

Figure 20: Thermal consideration

## THERMAL CURVE

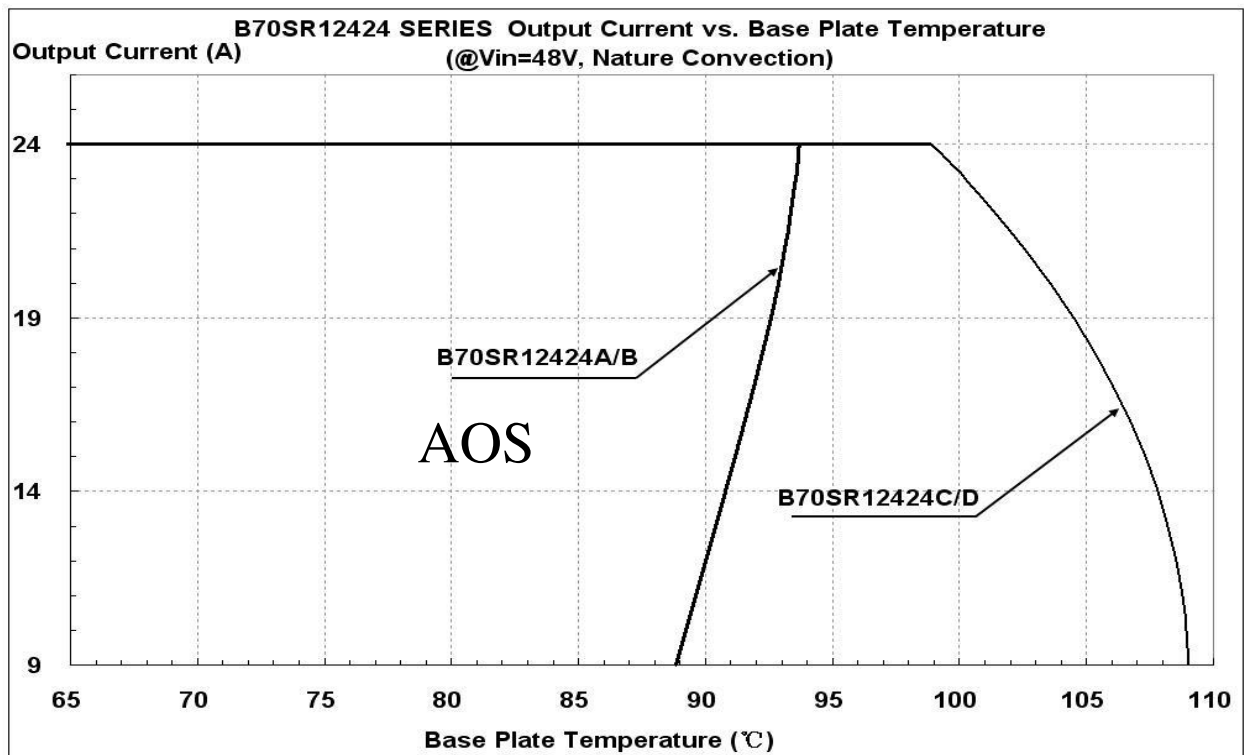

Figure 21: Output Current vs. base plate temperature @Vin=48V

## THERMAL CURVES

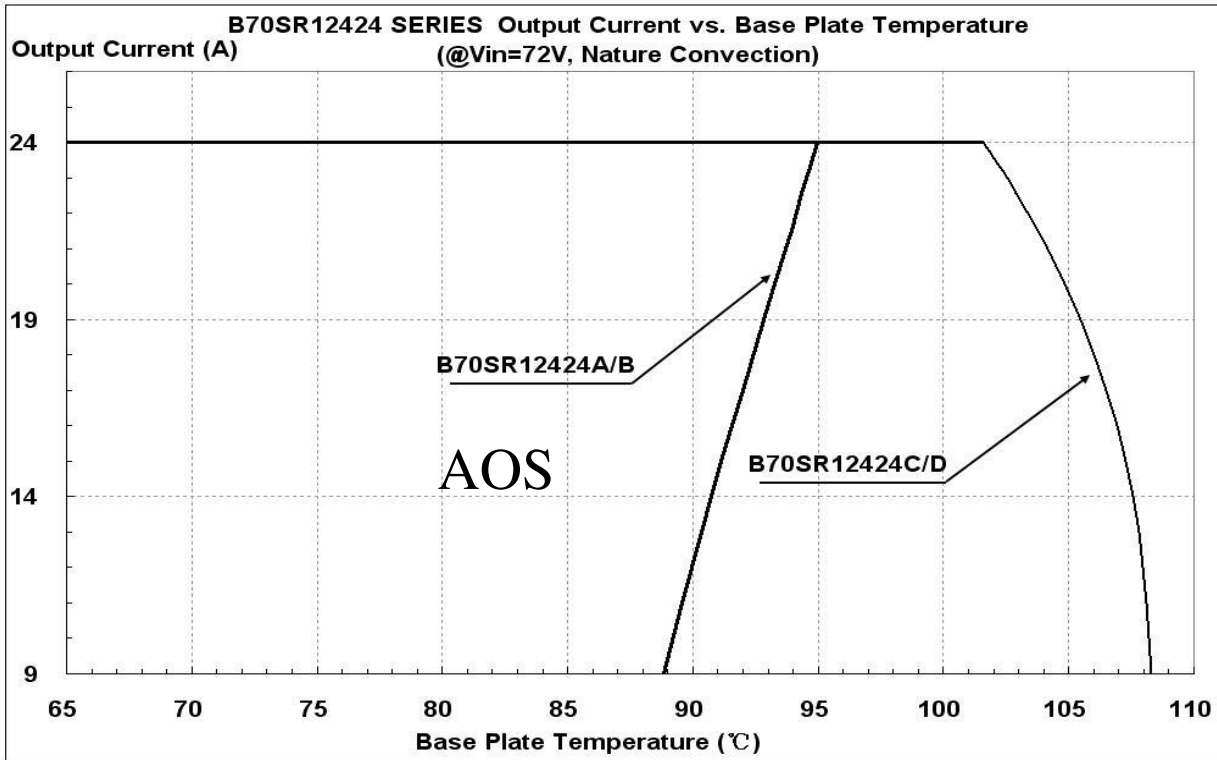

Figure 22: Output Current vs. base plate temperature @Vin=72V

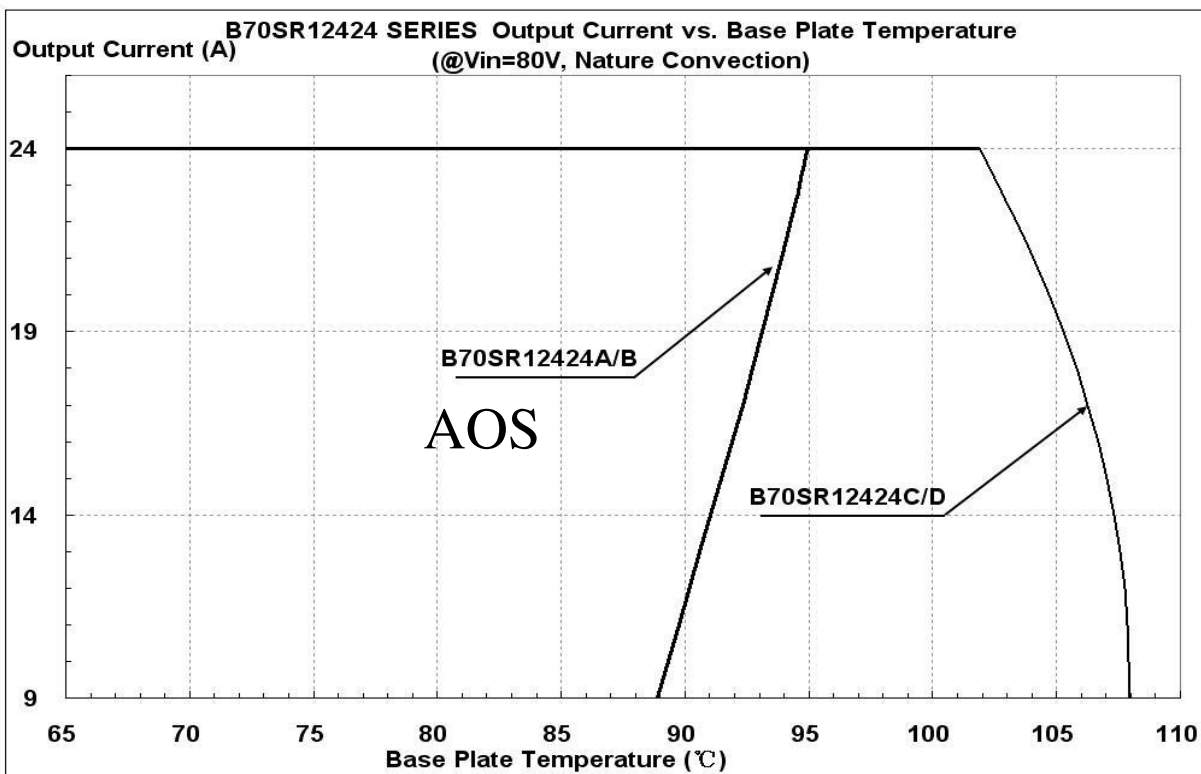
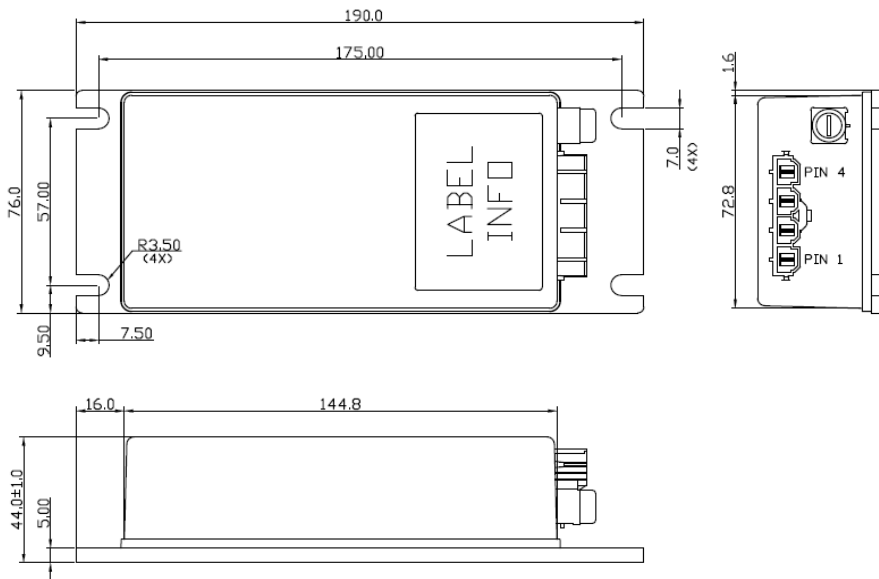

Figure 23: Output Current vs. base plate temperature @Vin=80V

## Mechanical Drawing

### Mechanical Dimensions



B70SR12424A

### Pin Connections

Pin	Function Description
1	OUTPUT -
2	OUTPUT +
3	INPUT -
4	INPUT +

- All dimensions in mm (inches)
- Tolerance: X.X±0.5 (X.XX±0.02)  
X.XX±0.25 ( X.XXX±0.010)
- Connector:  
MOLEX MINI-FIT Sr™ Header  
(MOLEX P/N :42819-4213)

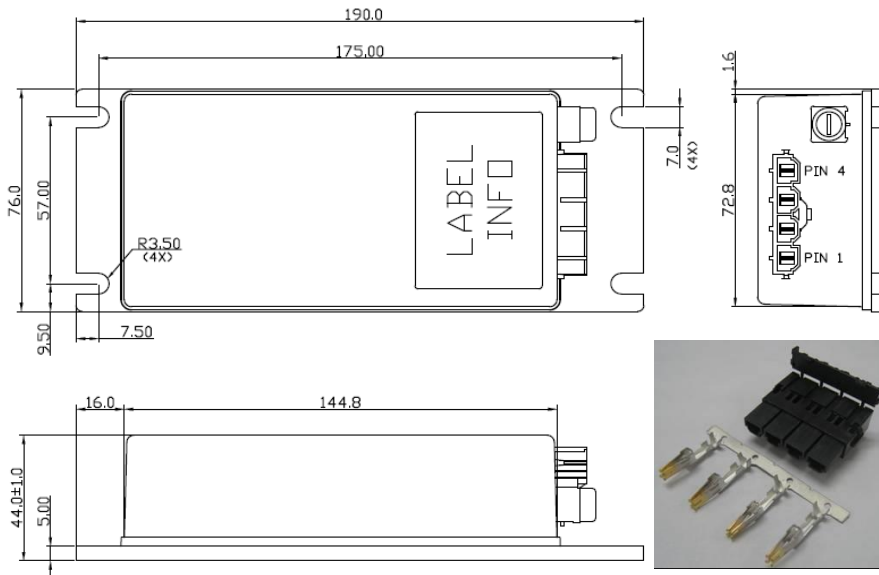

B70SR12424AC

Pin	Function Description
1	OUTPUT -
2	OUTPUT +
3	INPUT -
4	INPUT +

- All dimensions in mm (inches)
- Tolerance: X.X±0.5 (X.XX±0.02)  
X.XX±0.25 ( X.XXX±0.010)
- Connector:  
MOLEX MINI-FIT Sr™ Header  
(MOLEX P/N :42819-4213)
- Connector kit :  
Housing: 42816-0412  
Terminal: 42815-0042

## Mechanical Drawing

### Mechanical Dimensions

### Pin Connections

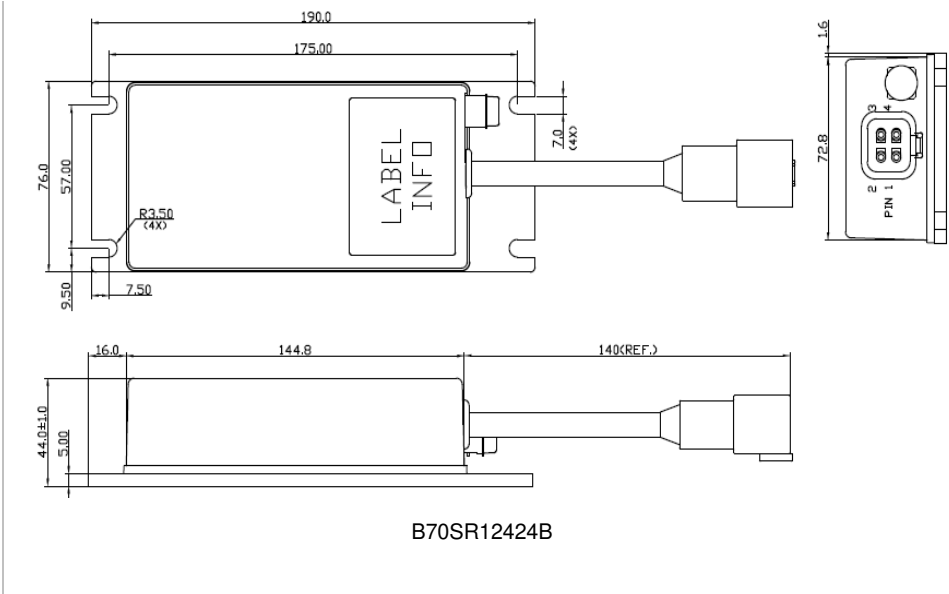

Pin	Function Description
1	OUTPUT -
2	OUTPUT +
3	INPUT -
4	INPUT +

- All dimensions in mm (inches)
- Tolerance: X.X±0.5 (X.XX±0.02)  
X.XX±0.25 ( X.XXX±0.010)
- Connector:  
Deutsch DTP Receptacles  
(DEUTSCH P/N :DTP04-4P)

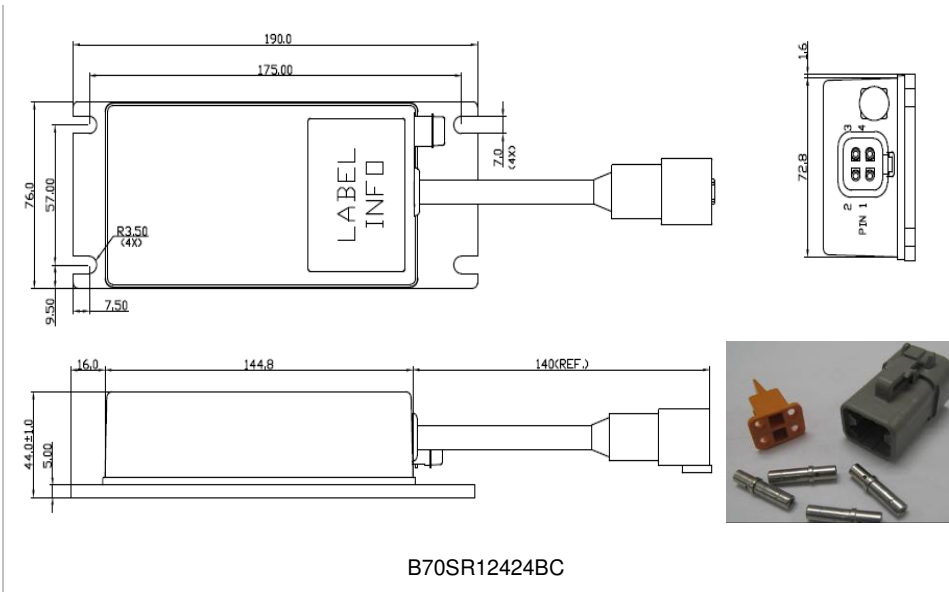

Pin	Function Description
1	OUTPUT -
2	OUTPUT +
3	INPUT -
4	INPUT +

- All dimensions in mm (inches)
- Tolerance: X.X±0.5 (X.XX±0.02)  
X.XX±0.25 ( X.XXX±0.010)
- Connector:  
Deutsch DTP Receptacles  
(DEUTSCH P/N :DTP04-4P)
- Connector kit :  
Housing: DTP06-4S  
Wedge lock: WP-4S  
Terminal: 0462-203-12141

## Mechanical Drawing

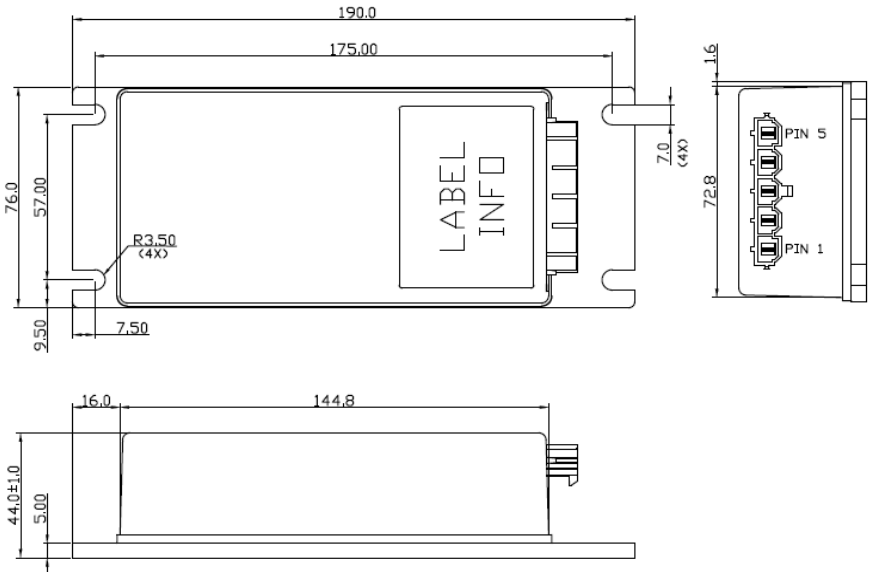
Mechanical Dimensions		Pin Connections	
		Pin	Function Description
		1	OUTPUT -
		2	OUTPUT +
		3	INPUT -
		4	INPUT +
		5	ENABLE
		<ul style="list-style-type: none"> <li>➤ All dimensions in mm (inches)</li> <li>➤ Tolerance: X.X±0.5 (X.XX±0.02) X.XX±0.25 (X.XXX±0.010)</li> <li>➤ Connector: MOLEX MINI-FIT Sr™ Header (MOLEX P/N :42819-5213)</li> </ul>	
B70SR12424C			

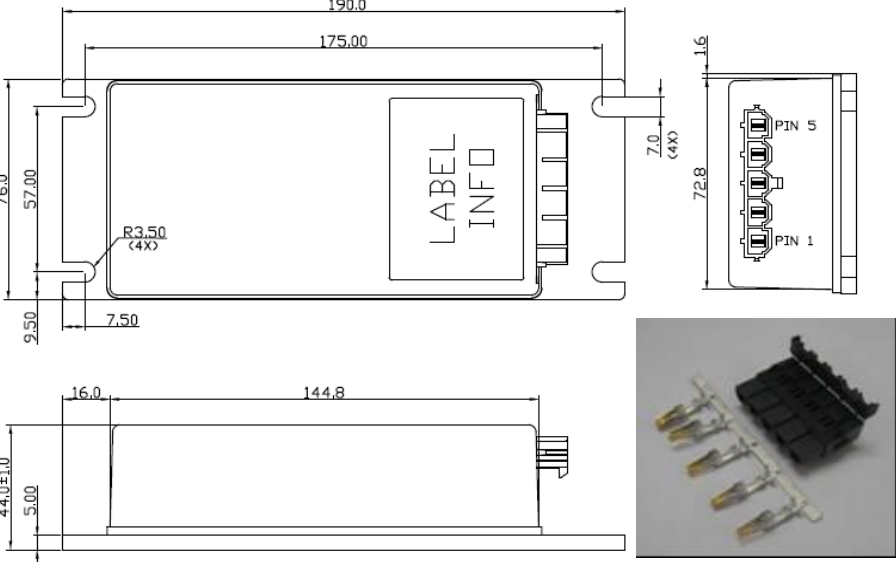
		Pin	Function Description
		1	OUTPUT -
		2	OUTPUT +
		3	INPUT -
		4	INPUT +
		5	ENABLE
		<ul style="list-style-type: none"> <li>➤ All dimensions in mm (inches)</li> <li>➤ Tolerance: X.X±0.5 (X.XX±0.02) X.XX±0.25 (X.XXX±0.010)</li> <li>➤ Connector: MOLEX MINI-FIT Sr™ Header (MOLEX P/N :42819-5213)</li> <li>➤ Connector kit : Housing: 42816-0512 Terminal: 42815-0042</li> </ul>	
B70SR12424CC			

## Mechanical Drawing

Mechanical Dimensions		Pin Connections											
		<table border="1"> <thead> <tr> <th>Pin</th> <th>Function Description</th> </tr> </thead> <tbody> <tr> <td>1</td> <td>OUTPUT -</td> </tr> <tr> <td>2</td> <td>OUTPUT +</td> </tr> <tr> <td>3</td> <td>INPUT -</td> </tr> <tr> <td>4</td> <td>INPUT +</td> </tr> </tbody> </table>		Pin	Function Description	1	OUTPUT -	2	OUTPUT +	3	INPUT -	4	INPUT +
Pin	Function Description												
1	OUTPUT -												
2	OUTPUT +												
3	INPUT -												
4	INPUT +												
<p>B70SR12424D</p>		<ul style="list-style-type: none"> <li>➤ All dimensions in mm (inches)</li> <li>➤ Tolerance: X.X±0.5 (X.XX±0.02) X.XX±0.25 ( X.XXX±0.010)</li> <li>➤ Connector: MOLEX MINI-FIT Sr™ Header (MOLEX P/N :42819-4213)</li> </ul>											

		<table border="1"> <thead> <tr> <th>Pin</th> <th>Function Description</th> </tr> </thead> <tbody> <tr> <td>1</td> <td>OUTPUT -</td> </tr> <tr> <td>2</td> <td>OUTPUT +</td> </tr> <tr> <td>3</td> <td>INPUT -</td> </tr> <tr> <td>4</td> <td>INPUT +</td> </tr> </tbody> </table>		Pin	Function Description	1	OUTPUT -	2	OUTPUT +	3	INPUT -	4	INPUT +
Pin	Function Description												
1	OUTPUT -												
2	OUTPUT +												
3	INPUT -												
4	INPUT +												
<p>B70SR12424DC</p>		<ul style="list-style-type: none"> <li>➤ All dimensions in mm (inches)</li> <li>➤ Tolerance: X.X±0.5 (X.XX±0.02) X.XX±0.25 ( X.XXX±0.010)</li> <li>➤ Connector: MOLEX MINI-FIT Sr™ Header (MOLEX P/N :42819-4213)</li> <li>➤ Connector kit : Housing: 42816-0412 Terminal: 42815-0042</li> </ul>											

## Physical Outline

Case Size	: 190.0x76.0x44.0 mm (7.48"x2.99"x1.73")
Case Material	: Case: PC; Plate: AL6063



### Part Numbering System

B	70	S	R	124	24	A			C	
Form Factor	Input Voltage	Number of Outputs	Product Series	Output Voltage	Output Current	Option Code			Option Fitting	
B-Box	70 – 36V~106V	S – Single	R – Regular	124 – 12.4V	24 – 24A		With Built-in fuse holder	Enable pin	Sealed connector & fuse holder	Connector Kit
						A	YES	NO	NO	1xhousing+ 4 terminals
						B	YES	NO	YES	1xhousing+ 4 terminals
						C	NO	YES	NO	1xhousing+ 5 terminals
D	NO	NO	NO	1xhousing+ 4 terminals						

### Model List

Input Voltage Range	Input		Output		EFF @72VIN 100% LOAD
B70SR12424(A\B\C\D)	36V~106V	10A	12.4V	24A	90.0%

**CONTACT:** [www.deltaww.com/dcdc](http://www.deltaww.com/dcdc)

**Email:** [dcdc@deltaww.com](mailto:dcdc@deltaww.com)

**USA:**

Telephone:  
East Coast: 978-656-3993  
West Coast: 510-668-5100  
Fax: (978) 656 3964

**Europe:**

Phone: +31-20-655-0967  
Fax: +31-20-655-0999

**Asia & the rest of world:**

Telephone: +886 3 4526107  
ext 6220~6224  
Fax: +886 3 4513485

**WARRANTY**

Delta offers a two (2) years limited warranty. Complete warranty information is listed on our web site or is available upon request from Delta.

Information furnished by Delta is believed to be accurate and reliable. However, no responsibility is assumed by Delta for its use, nor for any infringements of patents or other rights of third parties, which may result from its use. No license is granted by implication or otherwise under any patent or patent rights of Delta. Delta reserves the right to revise these specifications at any time, without notice.