



Chipsmall Limited consists of a professional team with an average of over 10 year of expertise in the distribution of electronic components. Based in Hongkong, we have already established firm and mutual-benefit business relationships with customers from,Europe,America and south Asia,supplying obsolete and hard-to-find components to meet their specific needs.

With the principle of “Quality Parts,Customers Priority,Honest Operation,and Considerate Service”,our business mainly focus on the distribution of electronic components. Line cards we deal with include Microchip,ALPS,ROHM,Xilinx,Pulse,ON,Everlight and Freescale. Main products comprise IC,Modules,Potentiometer,IC Socket,Relay,Connector.Our parts cover such applications as commercial,industrial, and automotives areas.

We are looking forward to setting up business relationship with you and hope to provide you with the best service and solution. Let us make a better world for our industry!



Contact us

Tel: +86-755-8981 8866 Fax: +86-755-8427 6832

Email & Skype: info@chipsmall.com Web: www.chipsmall.com

Address: A1208, Overseas Decoration Building, #122 Zhenhua RD., Futian, Shenzhen, China



SIOV metal oxide varistors

Strap varistors, HighE, AdvanceD, LS41 series

Series/Type: B722*

Date: January 2018

© EPCOS AG 2018. Reproduction, publication and dissemination of this publication, enclosures hereto and the information contained therein without EPCOS' prior express consent is prohibited.

EPCOS AG is a TDK Group Company.

Construction

- Rectangular varistor element
- Coating: epoxy resin, flame-retardant to UL 94 V-0
- Bolt-holed strap terminals for screw fixing or soldering
- Bent or straight strap terminals

Features

- Dimensions equivalent to SIOV-LS40
- High surge current up to 50 kA
- Wide operating voltage range 130 ... 460 V_{RMS}
- Designed in accordance with the requirements of IEC 61643-1, class II, for low-voltage surge protection devices

Approvals

- UL
- CSA

Delivery mode

- Vacuum-packed styrofoam box

General technical data

Climatic category	to IEC 60068-1	40/85/56	
Operating temperature	to CECC 42000	-25 ... + 85	°C
Storage temperature		-25 ... +110	°C
Electric strength	to CECC 42 000	≥ 2.5	kV _{RMS}
Insulation resistance	to CECC 42 000	≥ 10	MΩ

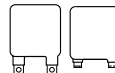
Electrical specifications and ordering codes
Maximum ratings ($T_A = 85\text{ °C}$)

Ordering code	Type	V_{RMS}	V_{DC}	$I_{max}^{(1)}$ (8/20 μ s) 1 time	$I_n^{(2)}$ (8/20 μ s) 15 times	W_{max} (2 ms)	P_{max}
	SIOV-	V	V	A	A	J	W
Bent strap terminals							
B72241L0131K100	LS41K130QP	130	170	50000	20000	310	1.4
B72241L0141K100	LS41K140QP	140	180	50000	20000	340	1.4
B72241L0151K100	LS41K150QP	150	200	50000	20000	360	1.4
B72241L0231K100	LS41K230QP	230	300	50000	20000	460	1.4
B72241L0251K100	LS41K250QP	250	320	50000	20000	490	1.4
B72241L0271K100	LS41K275QP	275	350	50000	20000	550	1.4
B72241L0321K100	LS41K320QP	320	420	50000	20000	640	1.4
B72241L0381K100	LS41K385QP	385	505	50000	20000	800	1.4
B72241L0421K100	LS41K420QP	420	560	50000	20000	910	1.4
B72241L0441K100	LS41K440QP	440	585	50000	20000	950	1.4
B72241L0461K100	LS41K460QP	460	615	50000	20000	960	1.4
Straight strap terminals							
B72241L0131K102	LS41K130QPK2	130	170	50000	20000	310	1.4
B72241L0141K102	LS41K140QPK2	140	180	50000	20000	340	1.4
B72241L0151K102	LS41K150QPK2	150	200	50000	20000	360	1.4
B72241L0231K102	LS41K230QPK2	230	300	50000	20000	460	1.4
B72241L0251K102	LS41K250QPK2	250	320	50000	20000	490	1.4
B72241L0271K102	LS41K275QPK2	275	350	50000	20000	550	1.4
B72241L0321K102	LS41K320QPK2	320	420	50000	20000	640	1.4
B72241L0381K102	LS41K385QPK2	385	505	50000	20000	800	1.4
B72241L0421K102	LS41K420QPK2	420	560	50000	20000	910	1.4
B72241L0441K102	LS41K440QPK2	440	585	50000	20000	950	1.4
B72241L0461K102	LS41K460QPK2	460	615	50000	20000	960	1.4

 1) I_{max} = Maximum discharge current to IEC 61643-11, class II

 2) I_n = Nominal discharge current to IEC 61643-11, class II

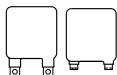
Strap varistors
B722*
HighE, AdvanceD, LS41 series
Characteristics (T_A = 25 °C)

Ordering code	Type	V _v	ΔV _v	V _{c,max}	i _c	C _{typ}
		(1 mA) V	(1 mA) %	(I _c) V	A	(1 kHz) pF
Bent strap terminals						
B72241L0131K100	LS41K130QP	205	±10	340	300	5600
B72241L0141K100	LS41K140QP	220	±10	365	300	5200
B72241L0151K100	LS41K150QP	240	±10	395	300	4800
B72241L0231K100	LS41K230QP	360	±10	595	300	3200
B72241L0251K100	LS41K250QP	390	±10	650	300	2900
B72241L0271K100	LS41K275QP	430	±10	710	300	2700
B72241L0321K100	LS41K320QP	510	±10	840	300	2300
B72241L0381K100	LS41K385QP	620	±10	1025	300	1900
B72241L0421K100	LS41K420QP	680	±10	1120	300	1800
B72241L0441K100	LS41K440QP	715	±10	1180	300	1700
B72241L0461K100	LS41K460QP	750	±10	1240	300	1600
Straight strap terminals						
B72241L0131K102	LS41K130QPK2	205	±10	340	300	5600
B72241L0141K102	LS41K140QPK2	220	±10	365	300	5200
B72241L0151K102	LS41K150QPK2	240	±10	395	300	4800
B72241L0231K102	LS41K230QPK2	360	±10	595	300	3200
B72241L0251K102	LS41K250QPK2	390	±10	650	300	2900
B72241L0271K102	LS41K275QPK2	430	±10	710	300	2700
B72241L0321K102	LS41K320QPK2	510	±10	840	300	2300
B72241L0381K102	LS41K385QPK2	620	±10	1025	300	1900
B72241L0421K102	LS41K420QPK2	680	±10	1120	300	1800
B72241L0441K102	LS41K440QPK2	715	±10	1180	300	1700
B72241L0461K102	LS41K460QPK2	750	±10	1240	300	1600

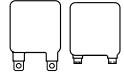
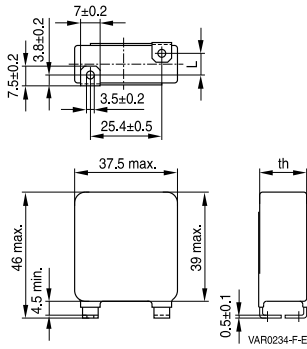

Dimensional drawings
Bent strap terminals

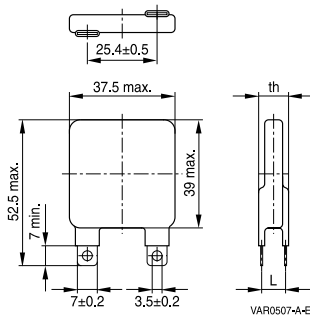
SIOV-LS41K ... QP

Weight: 20 ... 40 g

Straight strap terminals

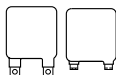
SIOV-LS41K ... QPK2

Weight: 20 ... 40 g

Ordering code	th _{max} mm	L ±1.0 mm
Bent strap terminals		
B72241L0131K100	8.1	-3.5
B72241L0141K100	8.2	-3.3
B72241L0151K100	8.3	-3.2
B72241L0231K100	9.0	-2.0
B72241L0251K100	9.2	-1.8
B72241L0271K100	9.4	-1.6
B72241L0321K100	9.9	-1.1
B72241L0381K100	10.6	-0.4
B72241L0421K100	10.9	0.0
B72241L0441K100	11.1	0.2
B72241L0461K100	11.4	0.4
Straight strap terminals		
B72241L0131K102	8.1	4.4
B72241L0141K102	8.2	4.5
B72241L0151K102	8.3	4.6
B72241L0231K102	9.0	5.4
B72241L0251K102	9.2	5.6
B72241L0271K102	9.4	5.8
B72241L0321K102	9.9	6.3
B72241L0381K102	10.6	6.9
B72241L0421K102	10.9	7.3
B72241L0441K102	11.1	7.6
B72241L0461K102	11.4	7.8



Strap varistors
B722*
HighE, AdvanceD, LS41 series
Reliability data

Test	Test methods/conditions	Requirement
Varistor voltage	The voltage between two terminals with the specified measuring current applied is called V_V (1 mA _{DC} @ 0.2 ... 2 s).	To meet the specified value
Clamping voltage	The maximum voltage between two terminals with the specified standard impulse current (8/20 μ s) applied.	To meet the specified value
Max. DC operating voltage	The maximum allowable DC operating voltage V_{DC} at UCT +5/-0 °C is applied for 1000 \pm 48 h. The leakage current I_{leak} (t) during test is recorded. Then the specimen shall be stored at room temperature and normal humidity for 1 to 2 h. Thereafter, the change of V_V shall be measured.	I_{leak} (t = 1000 h) \leq I_{leak} (t = 0 h) $ \Delta V/V$ (1 mA) \leq 10%
Surge current derating, 8/20 μ s	10 surge currents (8/20 μ s), unipolar, interval \geq 60 s, amplitude corresponding to derating curve for 10 impulses at 20 μ s	$ \Delta V/V$ (1 mA) \leq 10% (measured in direction of surge current) No visible damage
Fast temperature cycling	IEC 60068-2-14, test Na, LCT/UCT, dwell time 30 min, 5 cycles	$ \Delta V/V$ (1 mA) \leq 10% No visible damage
Damp heat, steady state	IEC 60068-2-78 The specimen shall be subjected to 40 \pm 2 °C, 90 to 95% r. H. for 56 \pm 2 days with 10% of the maximum continuous DC operating voltage V_{DC} . Then stored at room temperature and normal humidity for 1 to 2 h. Thereafter, the change of V_V shall be measured.	$ \Delta V/V$ (1 mA) \leq 10%

Note:

UCT = Upper category temperature

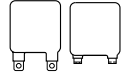
LCT = Lower category temperature



v/i characteristics

$v = f(i)$ for explanation of the characteristics refer to "General technical information", chapter 1.6.3
 A = Leakage current, B = Protection level } for worst-case varistor tolerances

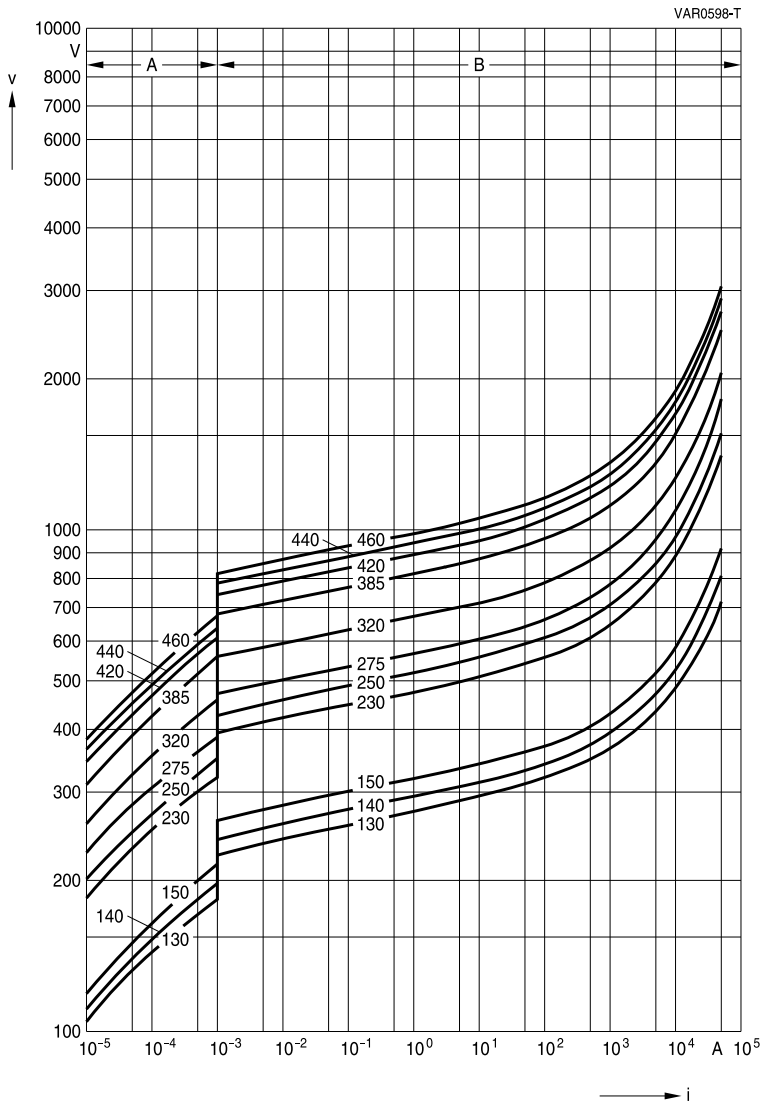

SIOV-LS41K130QP(K2) ... K460QP(K2)

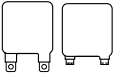

Derating curves

Maximum surge current $i_{max} = f(t_r, \text{pulse train})$

For explanation of the derating curves refer to "General technical information", section 1.8.1

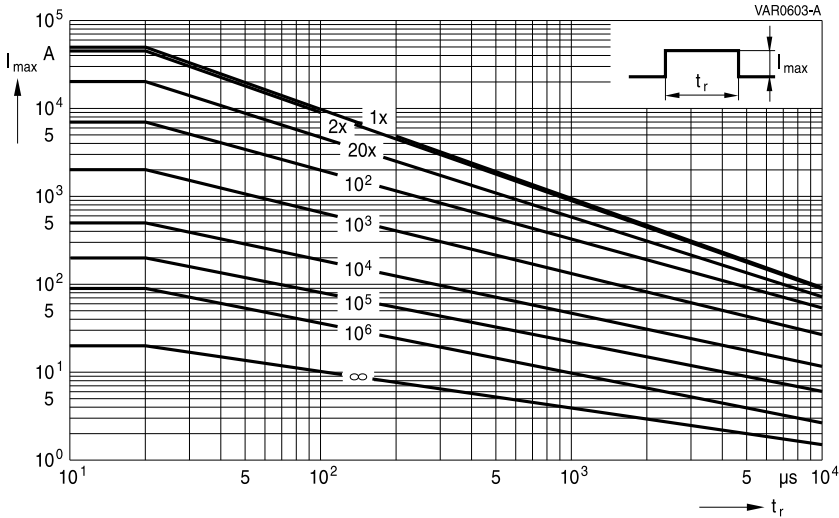

SIOV-LS41K130QP(K2) ... K150QP(K2)

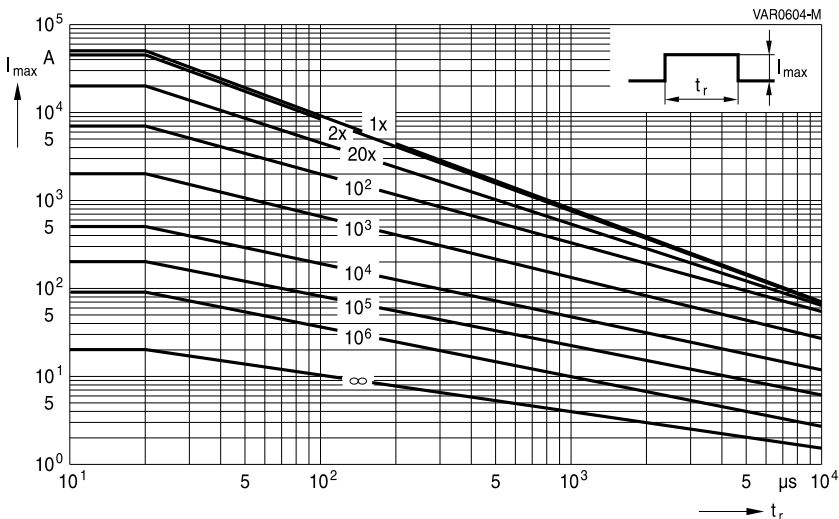

SIOV-LS41K230QP(K2) ... K460QP(K2)

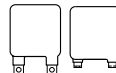

Cautions and warnings

General

1. EPCOS metal oxide varistors are designed for specific applications and should not be used for purposes not identified in our specifications, application notes and data books unless otherwise agreed with EPCOS during the design-in-phase.
2. Ensure suitability of SIOVs through reliability testing during the design-in phase. SIOVs should be evaluated taking into consideration worst-case conditions.
3. For applications of SIOVs in line-to-ground circuits based on various international and local standards there are restrictions existing or additional safety measures required.

Storage

1. Store SIOVs only in original packaging. Do not open the package prior to processing.
2. Recommended storage conditions in original packaging:
 Storage temperature: $-25\text{ }^{\circ}\text{C} \dots +45\text{ }^{\circ}\text{C}$,
 Relative humidity: $<75\%$ annual average,
 $<95\%$ on maximum 30 days a year.
 Dew precipitation: is to be avoided.
3. Avoid contamination of an SIOV's during storage, handling and processing.
4. Avoid storage of SIOVs in harmful environments that can affect the function during long-term operation (examples given under operation precautions).
5. The SIOV type series should be soldered after shipment from EPCOS within the time specified:

SIOV-S, -Q, -LS, -B, -SNF	24 months
ETFV/ T series, -CU	12 months.

Handling

1. SIOVs must not be dropped.
2. Components must not be touched with bare hands. Gloves are recommended.
3. Avoid contamination of the surface of SIOV electrodes during handling, be careful of the sharp edge of SIOV electrodes.

Soldering (where applicable)

1. Use rosin-type flux or non-activated flux.
2. Insufficient preheating may cause ceramic cracks.
3. Rapid cooling by dipping in solvent is not recommended.
4. Complete removal of flux is recommended.
5. Temperatures of all preheat stages and the solder bath must be strictly controlled especially for T series (T14 and T20).

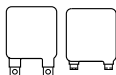

Mounting

1. Potting, sealing or adhesive compounds can produce chemical reactions in the SIOV ceramic that will degrade the component's electrical characteristics.
2. Overloading SIOVs may result in ruptured packages and expulsion of hot materials. For this reason SIOVs should be physically shielded from adjacent components.

Operation

1. Use SIOVs only within the specified temperature operating range.
2. Use SIOVs only within the specified voltage and current ranges.
3. Environmental conditions must not harm SIOVs. Use SIOVs only in normal atmospheric conditions. Avoid use in deoxidizing gases (chlorine gas, hydrogen sulfide gas, ammonia gas, sulfuric acid gas etc), corrosive agents, humid or salty conditions. Contact with any liquids and solvents should be prevented.

Display of ordering codes for EPCOS products

The ordering code for one and the same EPCOS product can be represented differently in data sheets, data books, other publications, on the EPCOS website, or in order-related documents such as shipping notes, order confirmations and product labels. **The varying representations of the ordering codes are due to different processes employed and do not affect the specifications of the respective products.** Detailed information can be found on the Internet under www.epcos.com/orderingcodes

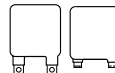
Symbols and terms

Symbol	Term
C	Capacitance
C_{typ}	Typical capacitance
i	Current
i_c	Current at which $V_{c, max}$ is measured
I_{leak}	Leakage current
i_{max}	Maximum surge current (also termed peak current)
I_{max}	Maximum discharge current
I_n	Nominal discharge current to UL 1449
LCT	Lower category temperature
L_{typ}	Typical inductance
P_{max}	Maximum average power dissipation
R_{ins}	Insulation resistance
R_{min}	Minimum resistance
T_A	Ambient temperature
t_r	Duration of equivalent rectangular wave
UCT	Upper category temperature
v	Voltage
V_{clamp}	Clamping voltage
$V_{c, max}$	Maximum clamping voltage at specified current i_c
V_{DC}	DC operating voltage
V_{jump}	Maximum jump start voltage
V_{max}	Maximum voltage
V_{op}	Operating voltage
V_{RMS}	AC operating voltage, root-mean-square value
$V_{RMS, op, max}$	Root-mean-square value of max. DC operating voltage incl. ripple current
V_{surge}	Super imposed surge voltage
V_V	Varistor voltage
ΔV_V	Tolerance of varistor voltage
W_{LD}	Maximum load dump
W_{max}	Maximum energy absorption
e	Lead spacing

All dimensions are given in mm.

The commas used in numerical values denote decimal points.

Important notes

The following applies to all products named in this publication:

1. Some parts of this publication contain **statements about the suitability of our products for certain areas of application**. These statements are based on our knowledge of typical requirements that are often placed on our products in the areas of application concerned. We nevertheless expressly point out **that such statements cannot be regarded as binding statements about the suitability of our products for a particular customer application**. As a rule, EPCOS is either unfamiliar with individual customer applications or less familiar with them than the customers themselves. For these reasons, it is always ultimately incumbent on the customer to check and decide whether an EPCOS product with the properties described in the product specification is suitable for use in a particular customer application.
2. We also point out that **in individual cases, a malfunction of electronic components or failure before the end of their usual service life cannot be completely ruled out in the current state of the art, even if they are operated as specified**. In customer applications requiring a very high level of operational safety and especially in customer applications in which the malfunction or failure of an electronic component could endanger human life or health (e.g. in accident prevention or lifesaving systems), it must therefore be ensured by means of suitable design of the customer application or other action taken by the customer (e.g. installation of protective circuitry or redundancy) that no injury or damage is sustained by third parties in the event of malfunction or failure of an electronic component.
3. **The warnings, cautions and product-specific notes must be observed.**
4. In order to satisfy certain technical requirements, **some of the products described in this publication may contain substances subject to restrictions in certain jurisdictions (e.g. because they are classed as hazardous)**. Useful information on this will be found in our Material Data Sheets on the Internet (www.epcos.com/material). Should you have any more detailed questions, please contact our sales offices.
5. We constantly strive to improve our products. Consequently, **the products described in this publication may change from time to time**. The same is true of the corresponding product specifications. Please check therefore to what extent product descriptions and specifications contained in this publication are still applicable before or when you place an order. We also **reserve the right to discontinue production and delivery of products**. Consequently, we cannot guarantee that all products named in this publication will always be available. The aforementioned does not apply in the case of individual agreements deviating from the foregoing for customer-specific products.
6. Unless otherwise agreed in individual contracts, **all orders are subject to the current version of the "General Terms of Delivery for Products and Services in the Electrical Industry" published by the German Electrical and Electronics Industry Association (ZVEI)**.

Important notes

7. The trade names EPCOS, CeraCharge, CeraDiode, CeraLink, CeraPad, CeraPlas, CSMP, CTVS, DeltaCap, DigiSiMic, ExoCore, FilterCap, FormFit, LeaXield, MiniBlue, MiniCell, MKD, MKK, MotorCap, PCC, PhaseCap, PhaseCube, PhaseMod, PhiCap, PowerHap, PQSine, PQvar, SIFERRIT, SIFI, SIKOREL, SilverCap, SIMDAD, SiMic, SIMID, SineFormer, SIOV, ThermoFuse, WindCap are **trademarks registered or pending** in Europe and in other countries. Further information will be found on the Internet at www.epcos.com/trademarks.