



Chipsmall Limited consists of a professional team with an average of over 10 year of expertise in the distribution of electronic components. Based in Hongkong, we have already established firm and mutual-benefit business relationships with customers from,Europe,America and south Asia,supplying obsolete and hard-to-find components to meet their specific needs.

With the principle of “Quality Parts,Customers Priority,Honest Operation,and Considerate Service”,our business mainly focus on the distribution of electronic components. Line cards we deal with include Microchip,ALPS,ROHM,Xilinx,Pulse,ON,Everlight and Freescale. Main products comprise IC,Modules,Potentiometer,IC Socket,Relay,Connector.Our parts cover such applications as commercial,industrial, and automotives areas.

We are looking forward to setting up business relationship with you and hope to provide you with the best service and solution. Let us make a better world for our industry!



Contact us

Tel: +86-755-8981 8866 Fax: +86-755-8427 6832

Email & Skype: info@chipsmall.com Web: www.chipsmall.com

Address: A1208, Overseas Decoration Building, #122 Zhenhua RD., Futian, Shenzhen, China



Comparator

Automotive Ground Sense Comparators

BA2903Yxxx-M BA2901Yxx-M

General Description

BA2903Yxxx-M and BA2901Yxx-M are manufactured for automotive. These products are open collector output comparators that can operate in single power supply. It features wide operating voltage range of 2V to 36V and with low supply current.

Applications are Car Navigation System, Car Audio, Automotive Body and Exteriors.

Features

- AEC-Q100 Qualified
- Single or Dual Power Supply Operation
- Wide Operating Supply Voltage
- Standard Comparator Pin-assignments
- Common-mode Input Voltage Range includes ground level.
- Wide Temperature Range

Application

- Car Navigation System
- Car Audio
- Automotive Body and Exteriors

Key Specifications

- Operating Supply Voltage Range
 - single supply : +2.0V to +36V
 - split supply : ±1.0V to ±18V
- Supply Current
 - BA2903Yxxx-M(Dual) 0.6mA(Typ)
 - BA2901Yxx-M(Quad) 0.8mA(Typ)
- Input Bias Current : 50nA(Typ)
- Input Offset Current : 5nA(Typ)
- Operating Temperature Range : -40°C to +125°C

Packages

	W(Typ) x D(Typ) x H(Max)
SOP8	5.00mm x 6.20mm x 1.71mm
SSOP-B8	3.00mm x 6.40mm x 1.35mm
MSOP8	2.90mm x 4.00mm x 0.90mm
SOP14	8.70mm x 6.20mm x 1.71mm
SSOP-B14	5.00mm x 6.40mm x 1.35mm

Simplified schematic

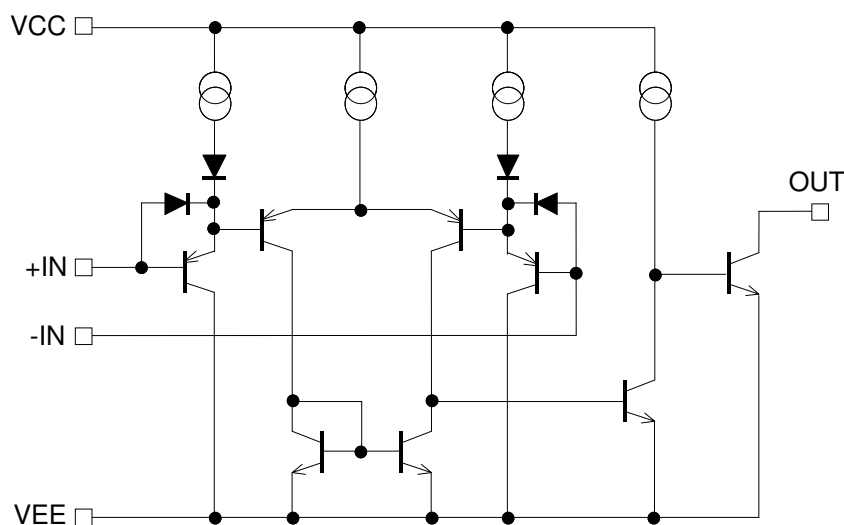
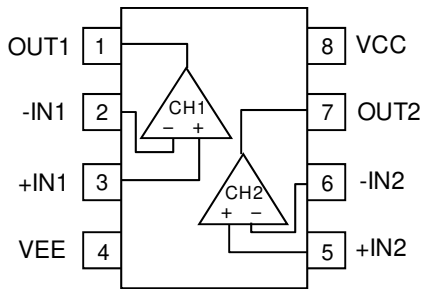

Figure 1. Simplified schematic (one channel only)

○Product structure : Silicon monolithic integrated circuit ○This product has no designed protection against radioactive rays

Pin Configuration

BA2903YF-M : SOP8
 BA2903YFV-M : SSOP-B8
 BA2903YFVM-M : MSOP8



Pin No.	Pin Name
1	OUT1
2	-IN1
3	+IN1
4	VEE
5	+IN2
6	-IN2
7	OUT2
8	VCC

BA2901YF-M : SOP14
 BA2901YFV-M : SSOP-B14

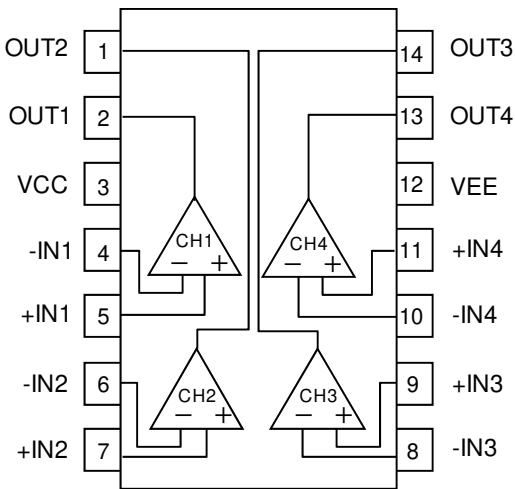

Pin No.	Pin Name
1	OUT2
2	OUT1
3	VCC
4	-IN1
5	+IN1
6	-IN2
7	+IN2
8	-IN3
9	+IN3
10	-IN4
11	+IN4
12	VEE
13	OUT4
14	OUT3

Package				
SOP8	SSOP-B8	MSOP8	SOP14	SSOP-B14
BA2903YF-M	BA2903YFV-M	BA2903YFVM-M	BA2901YF-M	BA2901YFV-M

Ordering Information

B	A	2	9	0	x	Y	x	x	x	-	M	x	x		
Part Number BA2903Yxxx BA2901Yxx										Package F : SOP8 SOP14 FV : SSOP-B8 SSOP-B14 FVM : MSOP8			Packaging and forming specification M: Automotive E2: Embossed tape and reel (SOP8/SOP14/SSOP-B8/ SSOP-B14) TR: Embossed tape and reel (MSOP8)		

Line-up

Topr	Operating Supply Voltage	Dual/Quad	Package		Orderable Part Number
-40°C to +125°C	+2.0V to +36V	Dual	SOP8	Reel of 2500	BA2903YF-ME2
			SSOP-B8	Reel of 2500	BA2903YFV-ME2
			MSOP8	Reel of 3000	BA2903YFVM-MTR
		Quad	SOP14	Reel of 2500	BA2901YF-ME2
			SSOP-B14	Reel of 2500	BA2901YFV-ME2

Absolute Maximum Ratings (T_A=25°C)

Parameter	Symbol	Ratings		Unit	
		BA2903Yxxx-C	BA2901Yxx-C		
Supply Voltage	VCC-VEE	+36		V	
Power dissipation	P _D	SOP8	0.77 (Note 1,6)	-	W
		SSOP-B8	0.62 (Note 2,6)	-	
		MSOP8	0.58 (Note 3,6)	-	
		SOP14	-	0.56 (Note 4,6)	
		SSOP-B14	-	0.87 (Note 5,6)	
Differential Input Voltage (Note 7)	V _{ID}	+36		V	
Input Common-mode Voltage Range	V _{ICM}	(VEE-0.3) to (VEE+36)		V	
Input Current (Note 8)	I _I	-10		mA	
Operating Supply Voltage	V _{opr}	+2.0 ~ +36 (±1.0 ~ ±18)		V	
Operating Temperature Range	T _{opr}	-40 to +125		°C	
Storage Temperature Range	T _{stg}	-55 to +150		°C	
Maximum junction Temperature	T _{Jmax}	+150		°C	

(Note 1) To use at temperature above T_A=25°C reduce 6.2mW/°C.

(Note 2) To use at temperature above T_A=25°C reduce 5.0mW/°C.

(Note 3) To use at temperature above T_A=25°C reduce 4.7mW/°C.

(Note 4) To use at temperature above T_A=25°C reduce 4.5mW/°C.

(Note 5) To use at temperature above T_A=25°C reduce 7.0mW/°C.

(Note 6) Mounted on a FR4 glass epoxy PCB 70mm×70mm×1.6mm (copper foil area less than 3%).

(Note 7) The voltage difference between inverting input and non-inverting input is the differential input voltage. Then input terminal voltage is set to more than VEE.

(Note 8) An excessive input current will flow when input voltages of less than VEE-0.6V are applied. The input current can be set to less than the rated current by adding a limiting resistor.

Caution: Operating the IC over the absolute maximum ratings may damage the IC. The damage can either be a short circuit between pins or an open circuit between pins and the internal circuitry. Therefore, it is important to consider circuit protection measures, such as adding a fuse, in case the IC is operated over the absolute maximum ratings.

Electrical Characteristics

OBA2903Yxxx-M (Unless otherwise specified VCC=+5V, VEE=0V)

Parameter	Symbol	Temperature range	Limits			Unit	Conditions
			Min	Typ	Max		
Input Offset Voltage ^(Note 9,10)	V _{IO}	25°C	-	2	7	mV	E _K =-1.4V
		Full range	-	-	15		VCC=5 to 36V, E _K =-1.4V
Input Offset Current ^(Note 9,10)	I _{IO}	25°C	-	5	50	nA	E _K =-1.4V
		Full range	-	-	200		
Input Bias Current ^(Note 10,11)	I _B	25°C	-	50	250	nA	E _K =-1.4V
		Full range	-	-	500		
Input Common-mode Voltage Range	V _{ICM}	25°C	0	-	VCC-1.5	V	-
Large Signal Voltage Gain	A _V	25°C	88	100	-	dB	VCC=15V, E _K =-1.4 to -11.4V R _L =15kΩ, V _{RL} =15V
		Full range	74	-	-		
Supply Current ^(Note 10)	I _{CC}	25°C	-	0.6	1	mA	OUT=open
		Full range	-	-	2.5		OUT=open, VCC=36V
Output Sink Current ^(Note 12)	I _{SINK}	25°C	6	16	-	mA	+IN=0V, -IN=1V OUT=1.5V
Output Saturation Voltage ^(Note 10) (Maximum Output Voltage Low)	V _{OL}	25°C	-	150	400	mV	+IN=0V, -IN= 1V I _{SINK} =4mA
		Full range	-	-	700		
Output Leakage Current ^(Note 10) (High level output current)	I _{LEAK}	25°C	-	0.1	-	μA	+IN=1V, -IN=0V OUT=5V
		Full range	-	-	1		+IN=1V, -IN=0V OUT=36V
Response Time	t _{RE}	25°C	-	1.3	-	μs	R _L =5.1kΩ, V _{RL} =5V V _{IN} =100mV _{P-P} , overdrive=5mV
			-	0.4	-		R _L =5.1kΩ, V _{RL} =5V, V _{IN} =TTL Logic Swing, V _{REF} =1.4V

(Note 9) Absolute value

(Note 10) Full range T_A=-40°C to +125°C

(Note 11) Current Direction: Since first input stage is composed with PNP transistor, input bias current flows out of IC.

(Note 12) Under high temperatures, please consider the power dissipation when selecting the output current.

When the output terminal is continuously shorted the output current reduces the internal temperature by flushing.

OBA2901Yxx-M (Unless otherwise specified VCC=+5V, VEE=0V)

Parameter	Symbol	Temperature range	Limits			Unit	Conditions
			Min	Typ	Max		
Input Offset Voltage ^(Note13,14)	V _{IO}	25°C	-	2	7	mV	E _K =-1.4V
		Full range	-	-	15		VCC=5 to 36V, E _K =-1.4V
Input Offset Current ^(Note13,14)	I _{IO}	25°C	-	5	50	nA	E _K =-1.4V
		Full range	-	-	200		
Input Bias Current ^(Note14,15)	I _B	25°C	-	50	250	nA	E _K =-1.4V
		Full range	-	-	500		
Input Common-mode Voltage Range	V _{ICM}	25°C	0	-	VCC-1.5	V	-
Large Signal Voltage Gain	A _V	25°C	88	100	-	dB	VCC=15V, E _K =-1.4 to -11.4V R _L =15kΩ, V _{RL} =15V
		Full range	74	-	-		
Supply Current ^(Note14)	I _{CC}	25°C	-	0.8	2	mA	OUT=open
		Full range	-	-	2.5		OUT=open, VCC=36V
Output Sink Current ^(Note16)	I _{SINK}	25°C	6	16	-	mA	+IN=0V, -IN=1V OUT=1.5V
Output Saturation Voltage ^(Note14) (Maximum Output Voltage Low)	V _{OL}	25°C	-	150	400	mV	+IN=0V, -IN= 1V I _{SINK} =4mA
		Full range	-	-	700		
Output Leakage Current ^(Note14) (High level output current)	I _{LEAK}	25°C	-	0.1	-	μA	+IN=1V, -IN=0V OUT=5V
		Full range	-	-	1		+IN=1V, -IN=0V OUT=36V
Response Time	t _{RE}	25°C	-	1.3	-	μs	R _L =5.1kΩ, V _{RL} =5V V _{IN} =100mV _{P-P} , overdrive=5mV
			-	0.4	-		R _L =5.1kΩ, V _{RL} =5V, V _{IN} =TTL Logic Swing, V _{REF} =1.4V

(Note 13) Absolute value

(Note 14) Full range T_A=-40°C to +125°C

(Note 15) Current Direction: Since first input stage is composed with PNP transistor, input bias current flows out of IC.

(Note 16) Under high temperatures, please consider the power dissipation when selecting the output current.

When the output terminal is continuously shorted the output current reduces the internal temperature by flushing.

Description of electrical characteristics

Described below are descriptions of the relevant electrical terms used in this datasheet. Items and symbols used are also shown. Note that item name and symbol and their meaning may differ from those on another manufacturer's document or general document.

1. Absolute maximum ratings

Absolute maximum rating items indicate the condition which must not be exceeded. Application of voltage in excess of absolute maximum rating or use out of absolute maximum rated temperature environment may cause deterioration of characteristics.

- (1) Supply Voltage (VCC/VEE)
Indicates the maximum voltage that can be applied between the positive power supply terminal and negative power supply terminal without deterioration or destruction of characteristics of internal circuit.
- (2) Differential Input Voltage (V_{ID})
Indicates the maximum voltage that can be applied between non-inverting and inverting terminals without damaging the IC.
- (3) Input Common-mode Voltage Range (V_{ICM})
Indicates the maximum voltage that can be applied to the non-inverting and inverting terminals without deterioration or destruction of electrical characteristics. Input common-mode voltage range of the maximum ratings does not assure normal operation of IC. For normal operation, use the IC within the input common-mode voltage range characteristics.
- (4) Operating and Storage Temperature Ranges (T_{opr}, T_{stg})
The operating temperature range indicates the temperature range within which the IC can operate. The higher the ambient temperature, the lower the power consumption of the IC. The storage temperature range denotes the range of temperatures the IC can be stored under without causing excessive deterioration of the electrical characteristics.
- (5) Power Dissipation (P_D)
Indicates the power that can be consumed by the IC when mounted on a specific board at the ambient temperature 25°C (normal temperature). As for package product, P_D is determined by the temperature that can be permitted by the IC in the package (maximum junction temperature) and the thermal resistance of the package.

2. Electrical characteristics

- (1) Input Offset Voltage (V_{IO})
Indicates the voltage difference between non-inverting terminal and inverting terminals. It can be translated into the input voltage difference required for setting the output voltage at 0 V.
- (2) Input Offset Current (I_{IO})
Indicates the difference of input bias current between the non-inverting and inverting terminals.
- (3) Input Bias Current (I_B)
Indicates the current that flows into or out of the input terminal. It is defined by the average of input bias currents at the non-inverting and inverting terminals.
- (4) Input Common-mode Voltage Range (V_{ICM})
Indicates the input voltage range where IC normally operates.
- (5) Large Signal Voltage Gain (A_V)
Indicates the amplifying rate (gain) of output voltage against the voltage difference between non-inverting terminal and inverting terminal. It is normally the amplifying rate (gain) with reference to DC voltage.
 $A_V = (\text{Output voltage}) / (\text{Differential Input voltage})$
- (6) Supply Current (I_{CC})
Indicates the current that flows within the IC under specified no-load conditions.
- (7) Output Sink Current (I_{SINK})
Denotes the maximum current that can be output under specific output conditions.
- (8) Output Saturation Voltage, Low Level Output Voltage (V_{OL})
Signifies the voltage range that can be output under specific output conditions.
- (9) Output Leakage Current, High Level Output Current (I_{LEAK})
Indicates the current that flows into the IC under specific input and output conditions.
- (10) Response Time (t_{RE})
Response time indicates the delay time between the input and output signal is determined by the time difference from the fifty percent of input signal swing to the fifty percent of output signal swing.

Typical Performance Curves

OBA2903Yxxx-M

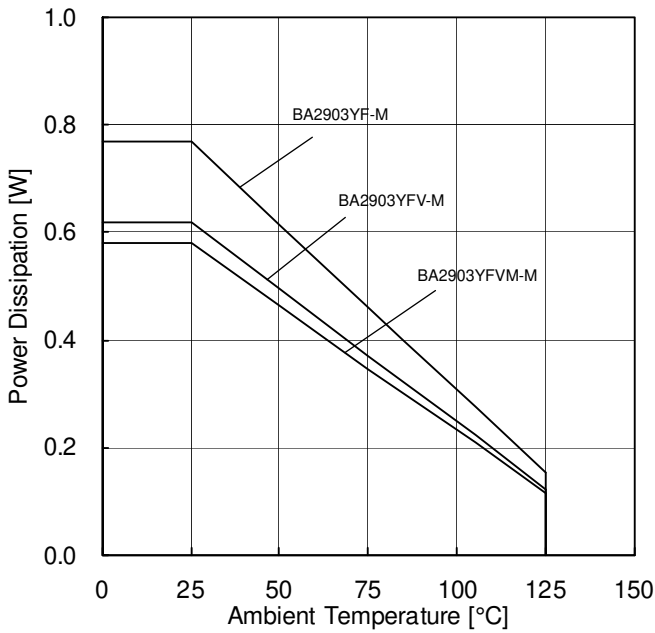

Figure 2.
Power Dissipation vs Ambient Temperature
(Derating Curve)

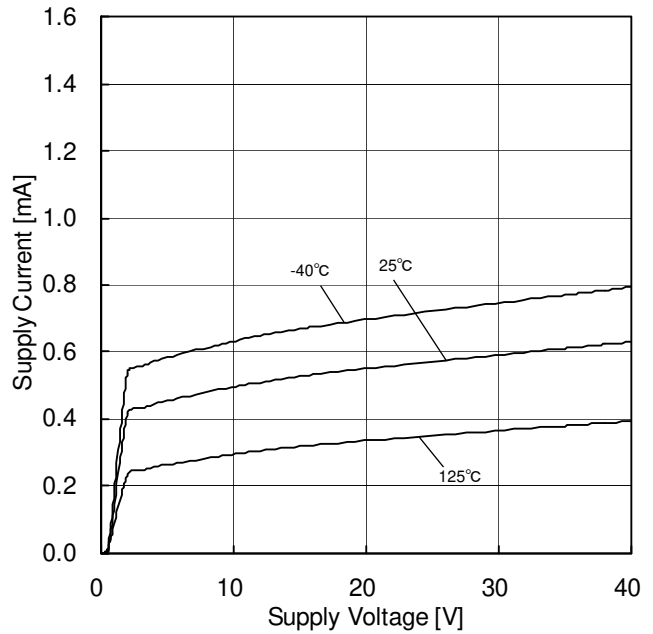

Figure 3.
Supply Current vs Supply Voltage

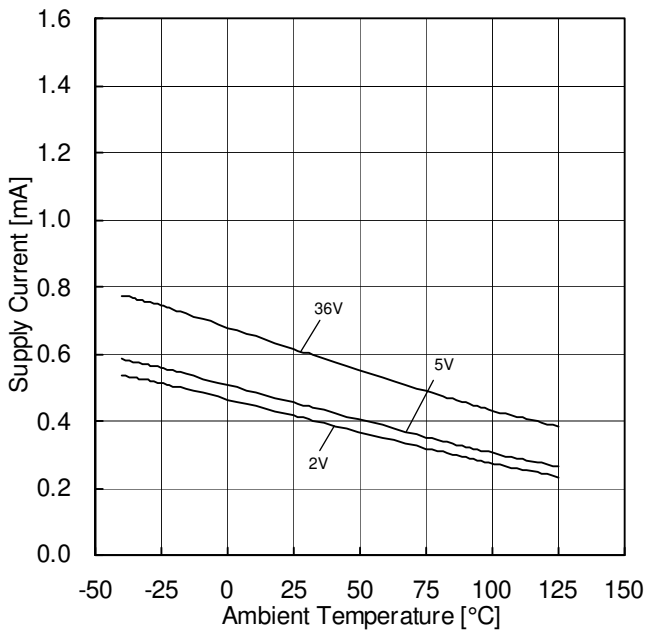

Figure 4.
Supply Current vs Ambient Temperature

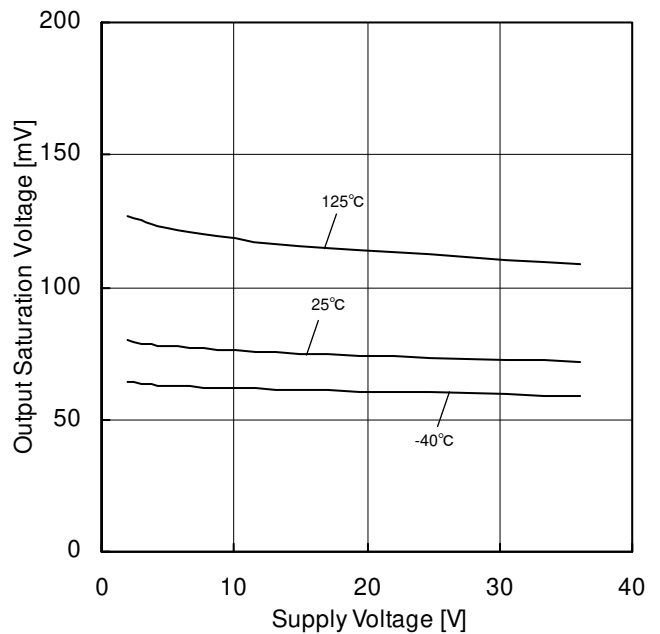

Figure 5.
Output Saturation Voltage vs Supply Voltage
($I_{SINK}=4mA$)

(*)The above characteristics are measurements of typical sample, they are not guaranteed.

Typical Performance Curves - continued

OBA2903Yxxx-M

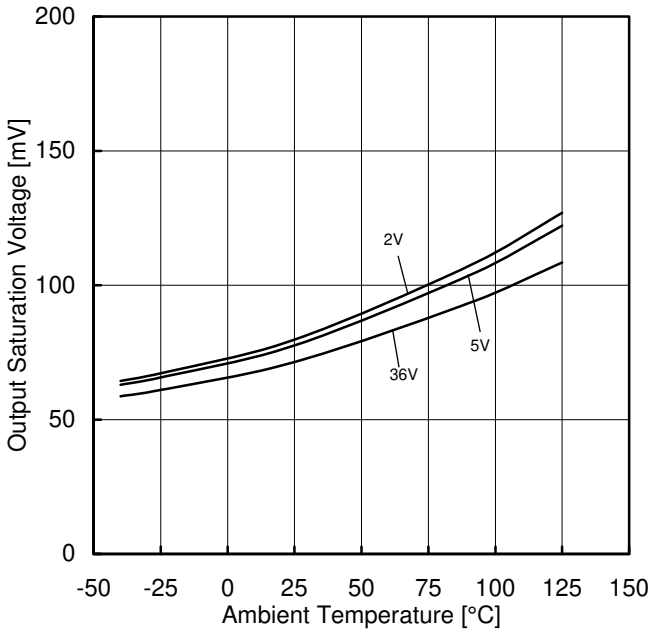

Figure 6.
Output Saturation Voltage vs Ambient Temperature
($I_{SINK}=4mA$)

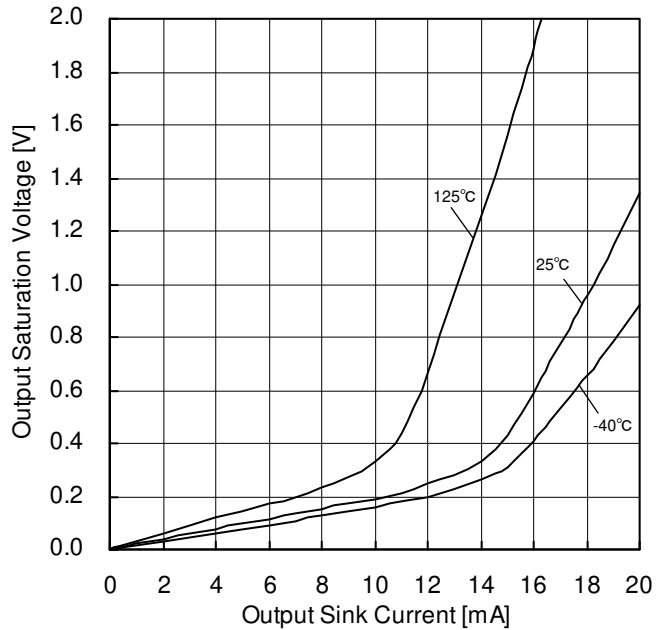

Figure 7.
Output Saturation Voltage vs
Output Sink Current
($VCC=5V$)

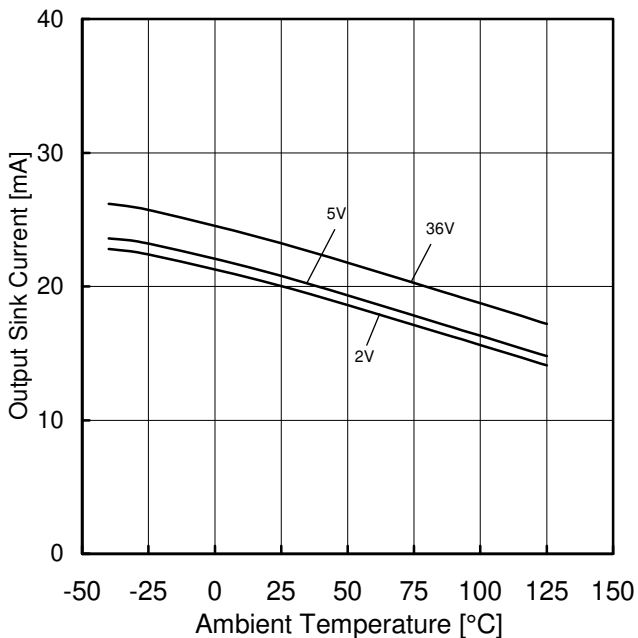

Figure 8.
Output Sink Current vs Ambient Temperature
($OUT=1.5V$)

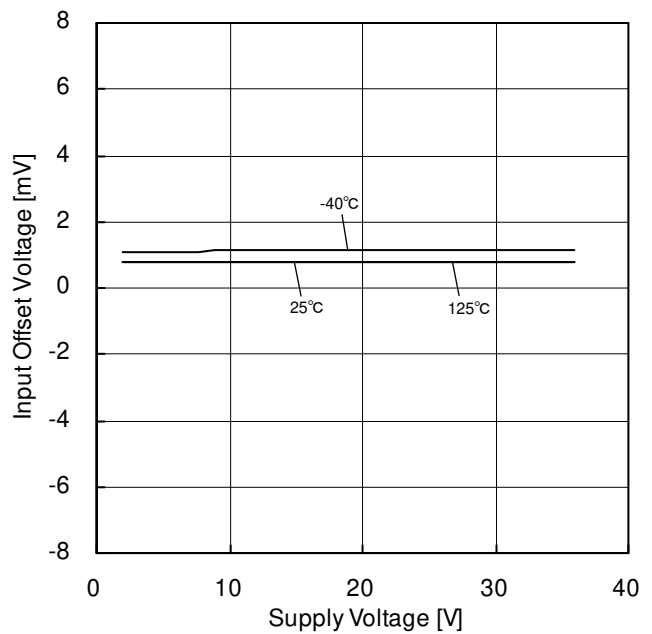

Figure 9.
Input Offset Voltage vs Supply Voltage

(*)The above characteristics are measurements of typical sample, they are not guaranteed.

Typical Performance Curves - continued

OBA2903Yxxx-M

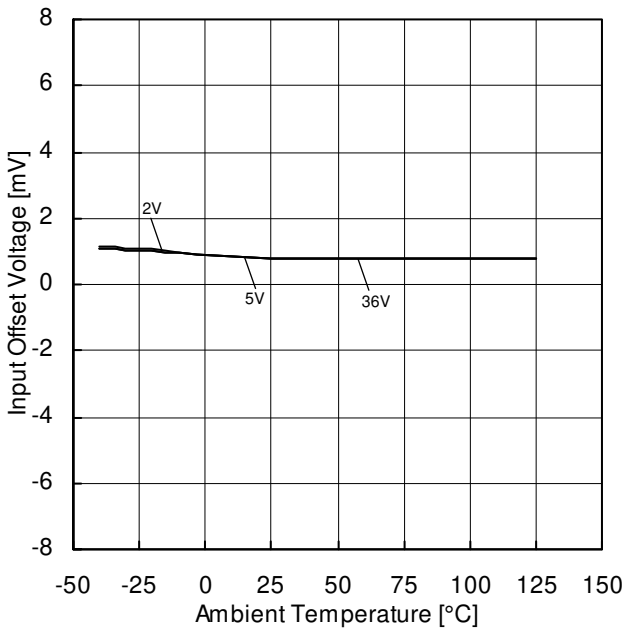

Figure 10.
Input Offset Voltage vs Ambient Temperature

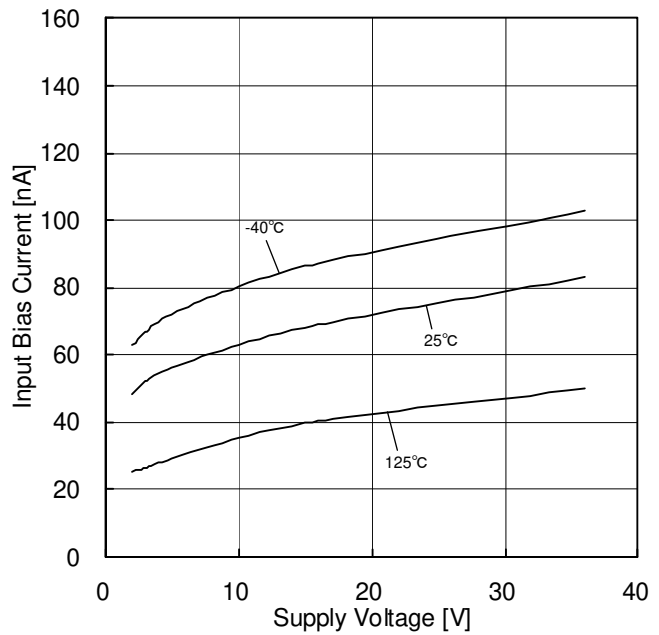

Figure 11.
Input Bias Current vs Supply Voltage

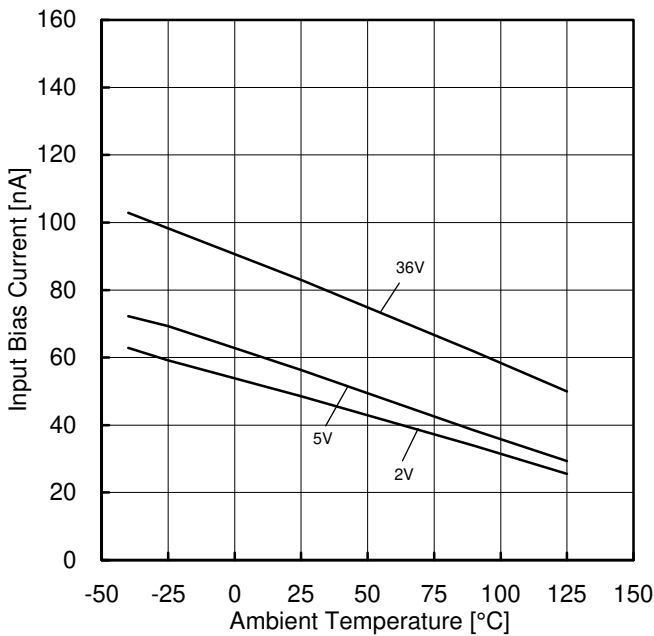

Figure 12.
Input Bias Current vs Ambient Temperature

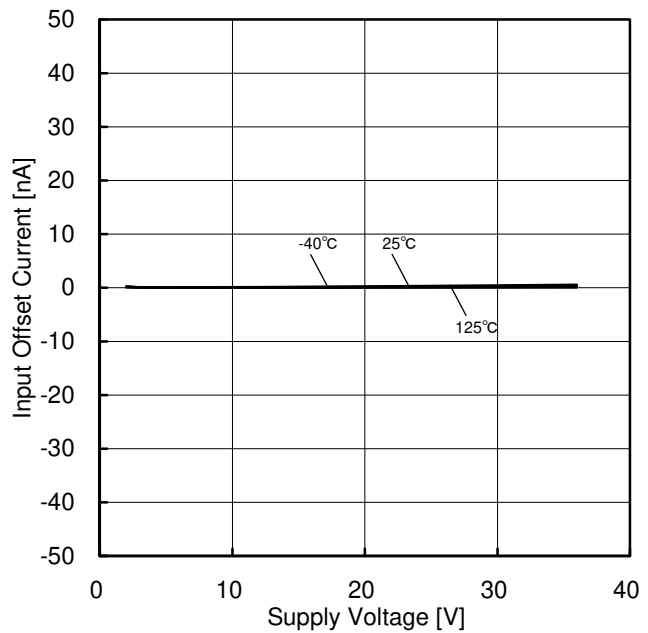

Figure 13.
Input Offset Current vs Supply Voltage

(*)The above characteristics are measurements of typical sample, they are not guaranteed.

Typical Performance Curves - continued

OBA2903Yxxx-M

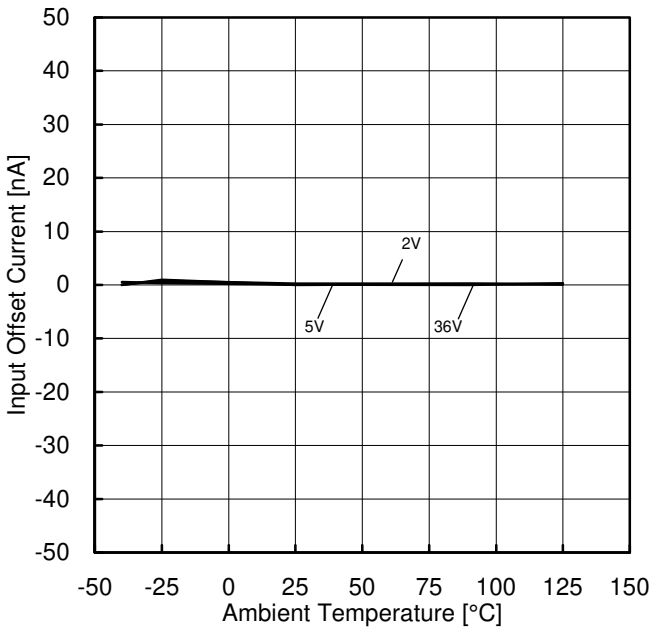

Figure 14.
Input Offset Current vs Ambient Temperature

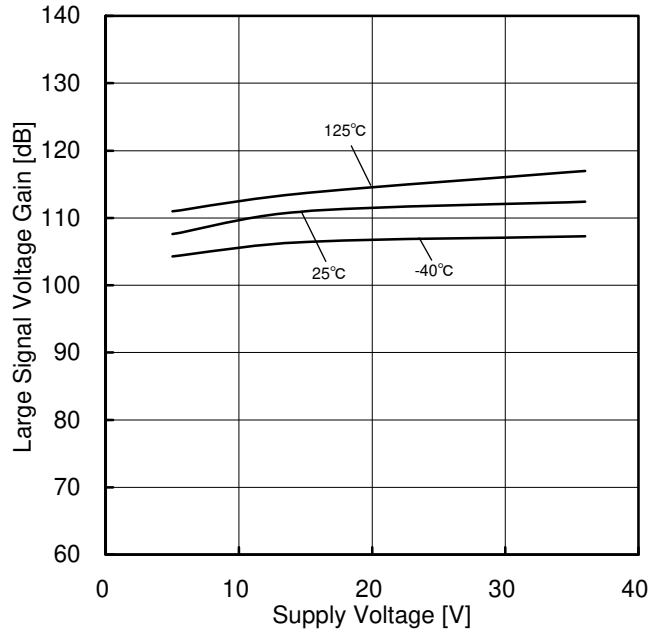

Figure 15.
Large Signal Voltage Gain vs Supply Voltage

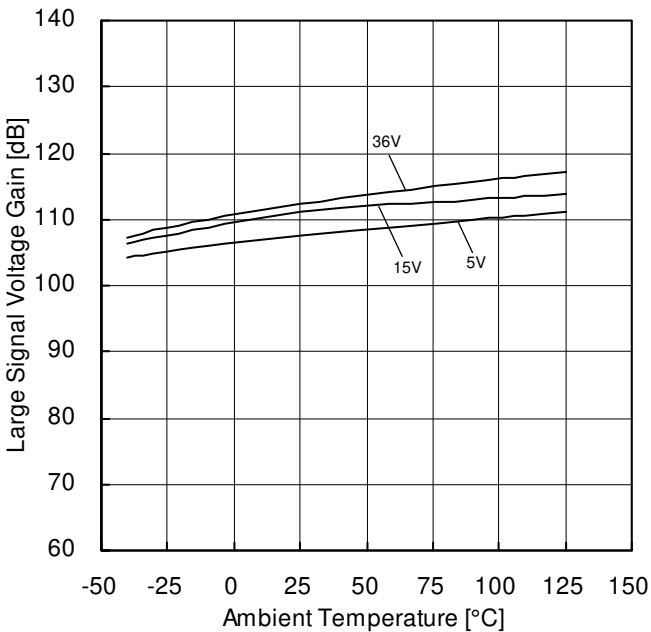

Figure 16.
Large Signal Voltage Gain vs Ambient Temperature

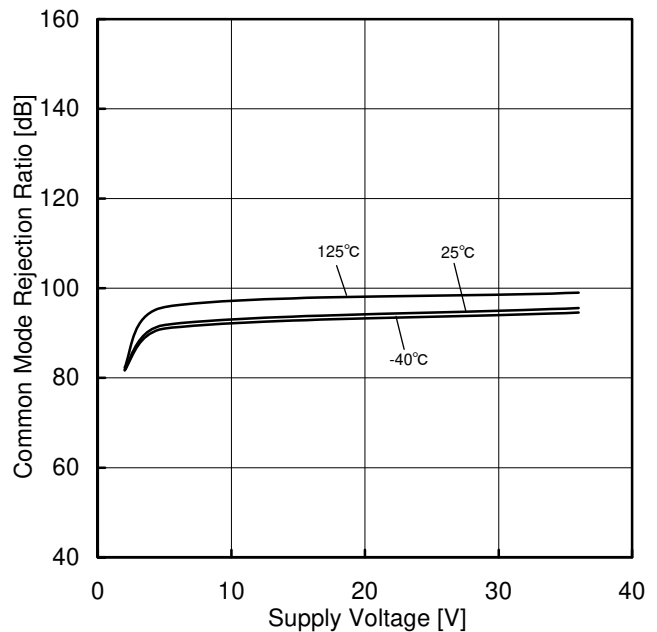

Figure 17.
Common Mode Rejection Ratio vs Supply Voltage

(*)The above characteristics are measurements of typical sample, they are not guaranteed.

Typical Performance Curves - continued

OBA2903Yxxx-M

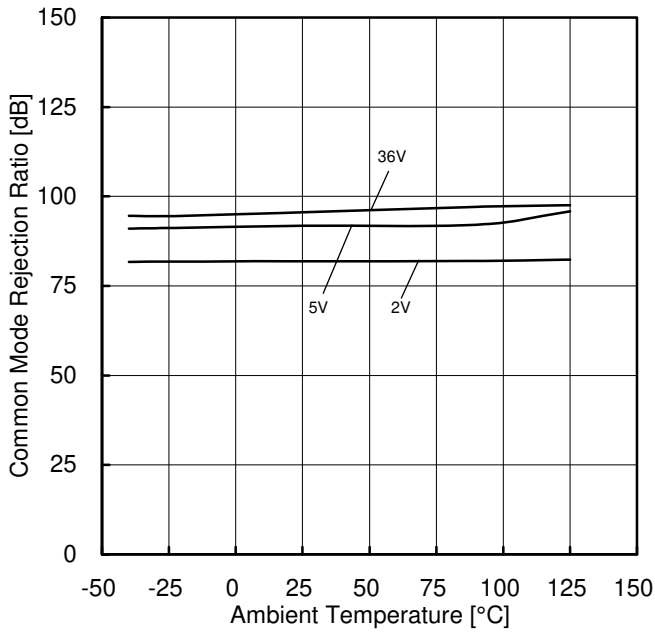

Figure 18.
Common Mode Rejection Ratio
vs Ambient Temperature

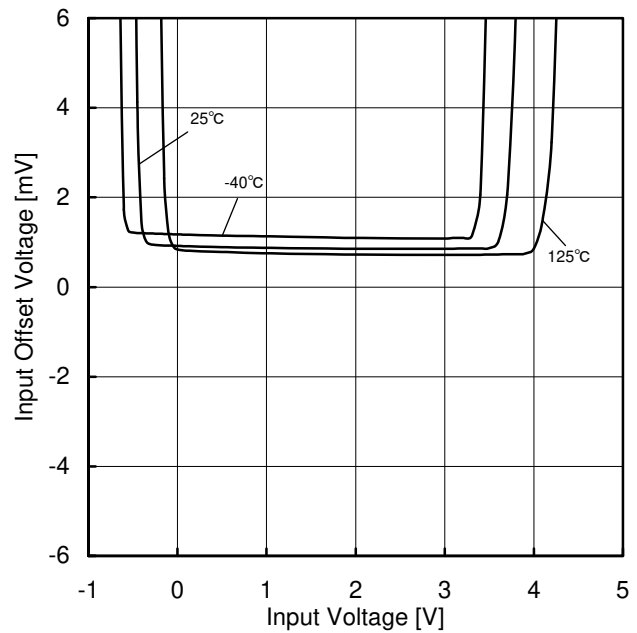

Figure 19.
Input Offset Voltage - Input Voltage
(VCC=5V)

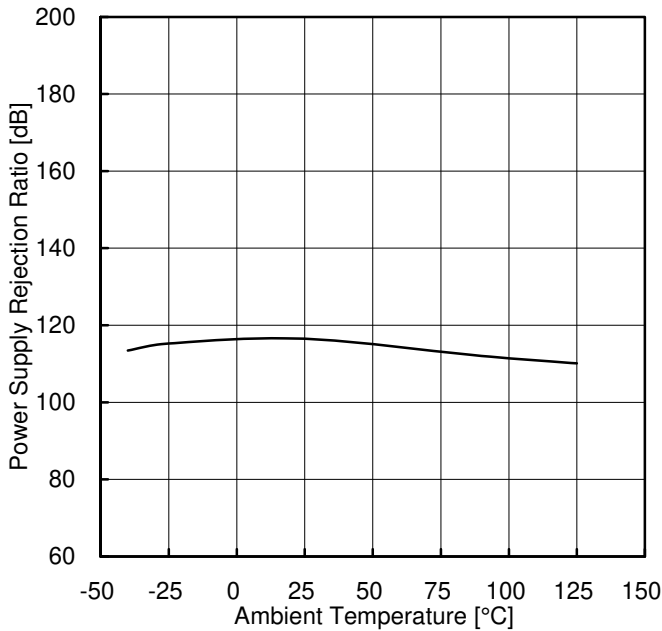

Figure 20.
Power Supply Rejection Ratio
vs Ambient Temperature

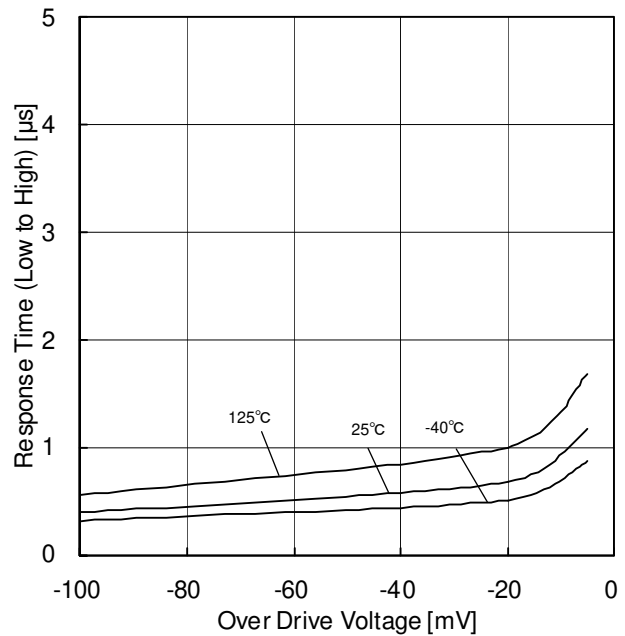

Figure 21.
Response Time (Low to High)
vs Over Drive Voltage
(VCC=5V, V_{RL}=5V, R_L=5.1kΩ)

(*)The above characteristics are measurements of typical sample, they are not guaranteed.

Typical Performance Curves - continued

OBA2903Yxxx-M

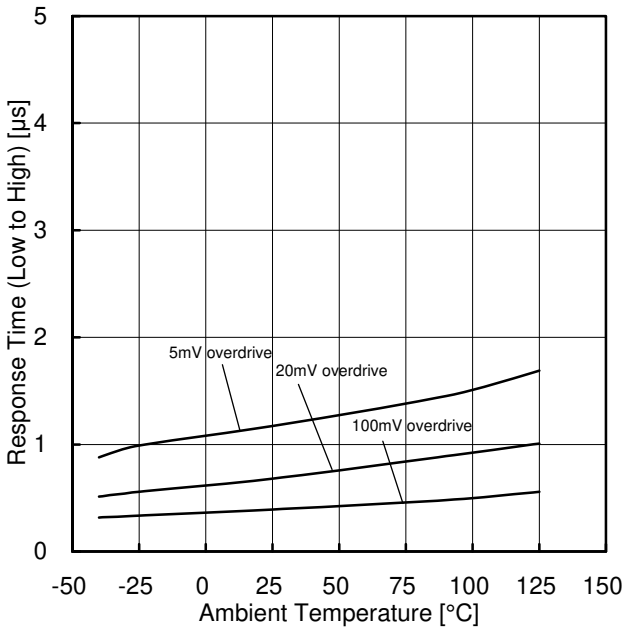

Figure 22.
Response Time (Low to High)
vs Ambient Temperature
(VCC=5V, V_{RL}=5V, R_L=5.1kΩ)

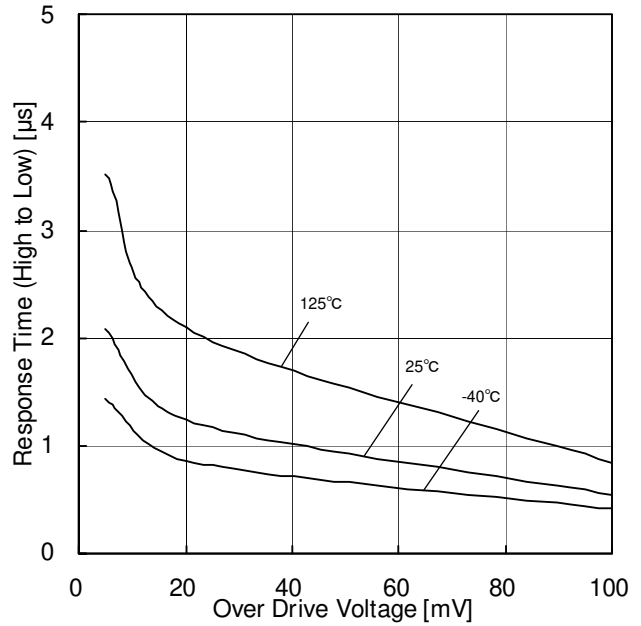

Figure 23.
Response Time (High to Low)
vs Over Drive Voltage
(VCC=5V, V_{RL}=5V, R_L=5.1kΩ)

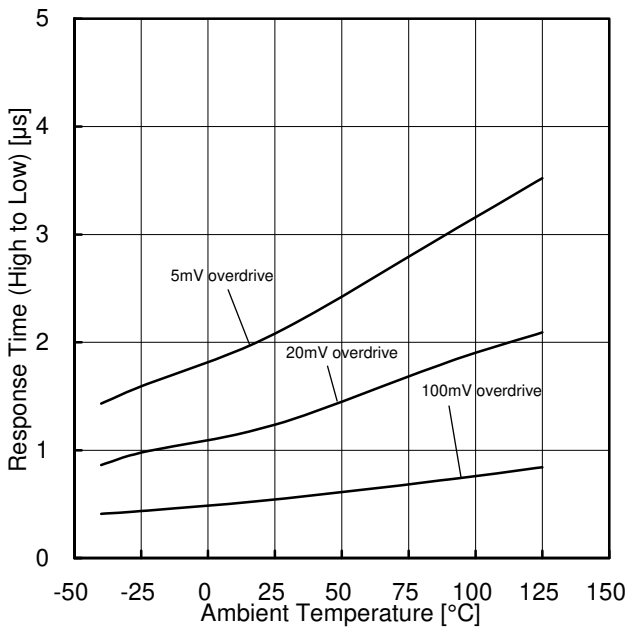

Figure 24.
Response Time (High to Low)
vs Ambient Temperature
(VCC=5V, V_{RL}=5V, R_L=5.1kΩ)

(*)The above characteristics are measurements of typical sample, they are not guaranteed.

Typical Performance Curves - continued

OBA2901Yxx-M

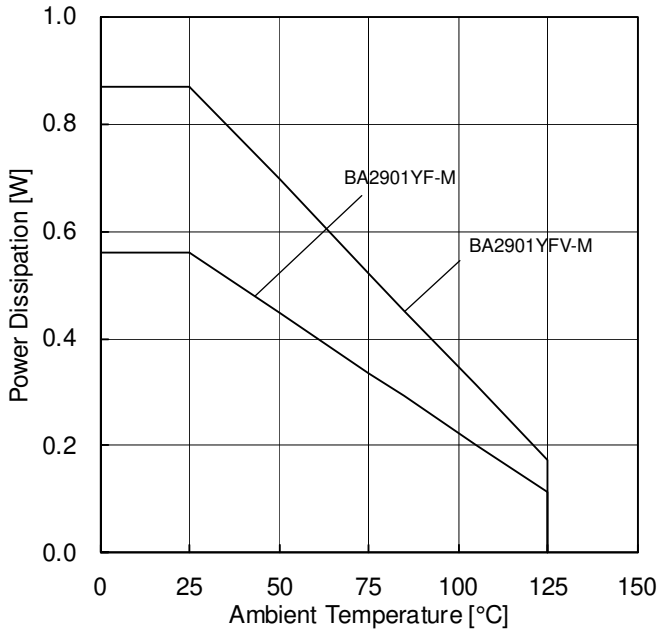

Figure 25.
Power Dissipation vs Ambient Temperature
(Derating Curve)

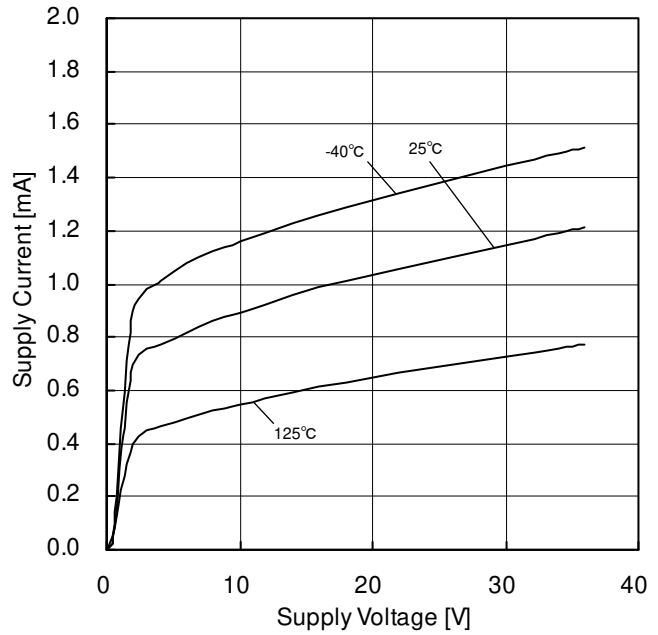

Figure 26.
Supply Current vs Supply Voltage

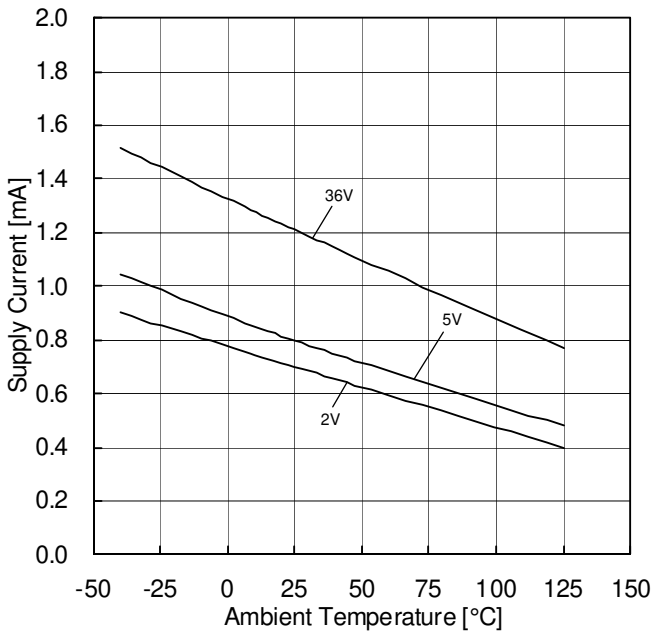

Figure 27.
Supply Current vs Ambient Temperature

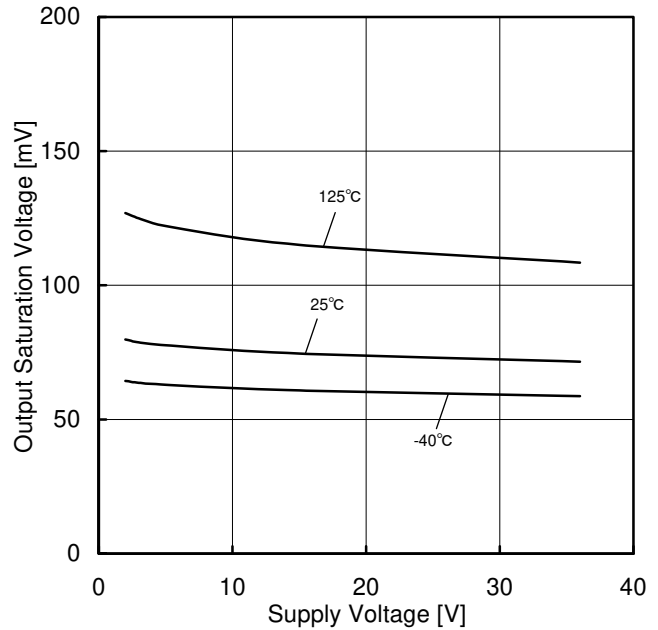

Figure 28.
Output Saturation Voltage vs Supply Voltage
(I_{SINK}=4mA)

(*)The above characteristics are measurements of typical sample, they are not guaranteed.

Typical Performance Curves - continued

OBA2901Yxx-M

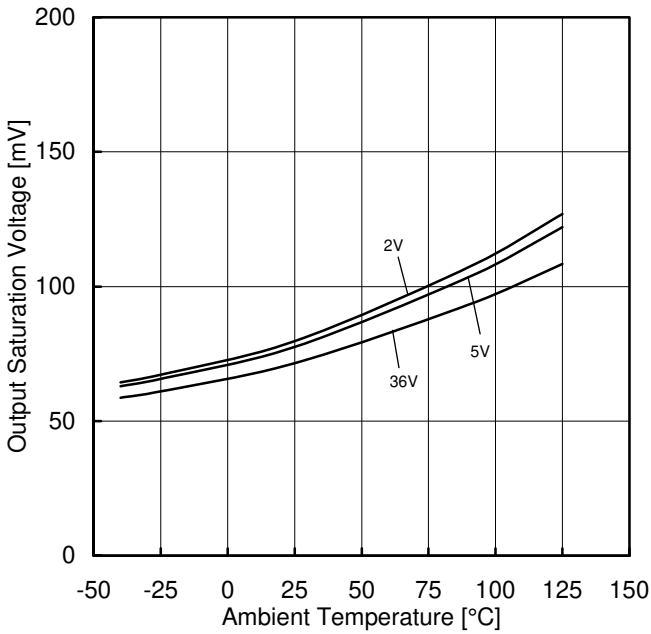

Figure 29.
Output Saturation Voltage vs Ambient Temperature
($I_{SINK}=4mA$)

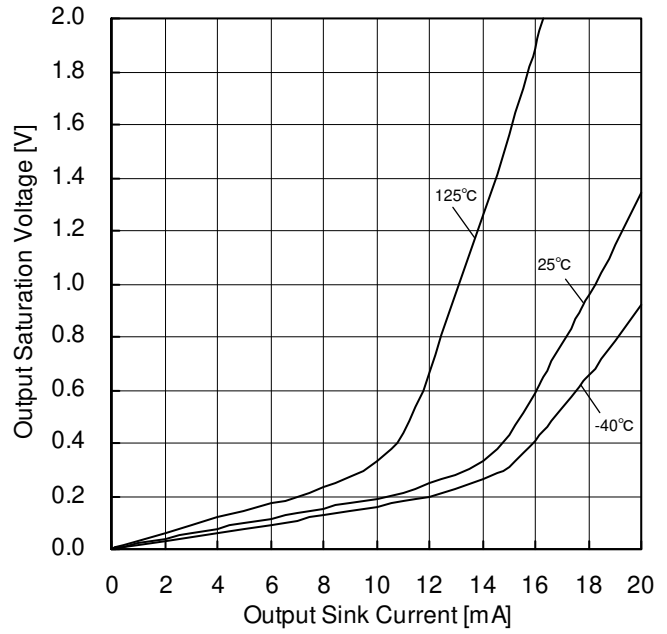

Figure 30.
Output Saturation Voltage vs Output Sink Current
($V_{CC}=5V$)

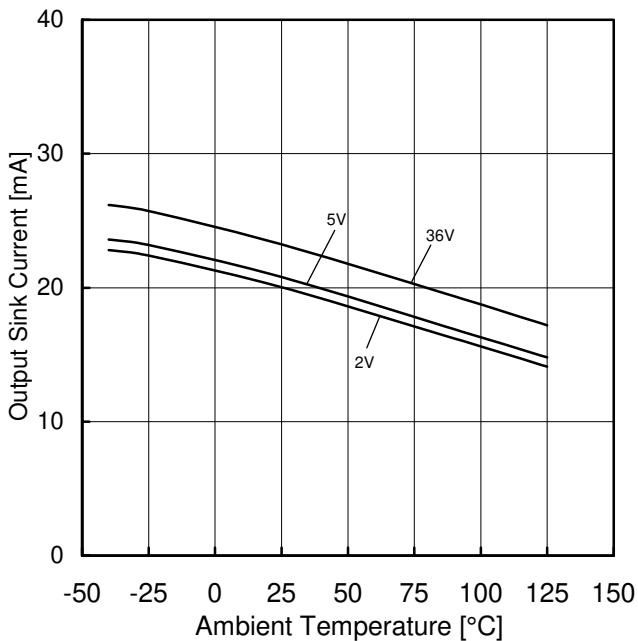

Figure 31.
Output Sink Current vs Ambient Temperature
($OUT=1.5V$)

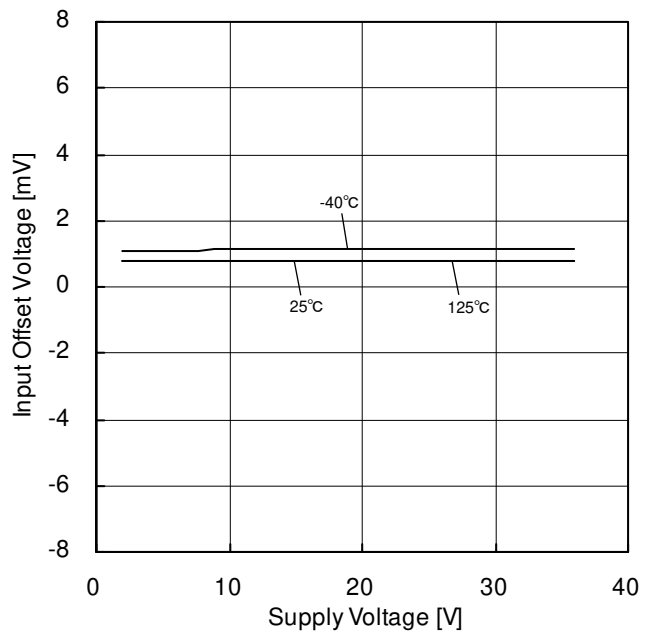

Figure 32.
Input Offset Voltage vs Supply Voltage

(*)The above characteristics are measurements of typical sample, they are not guaranteed.

Typical Performance Curves - continued

OBA2901Yxx-M

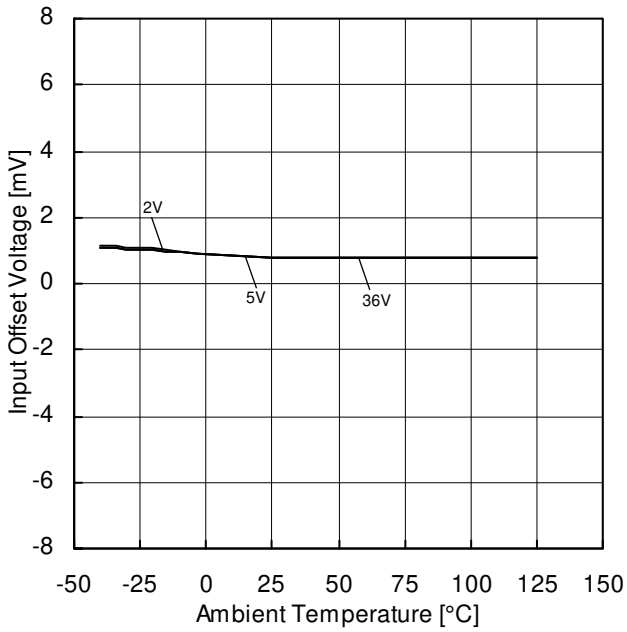

Figure 33.
Input Offset Voltage vs Ambient Temperature

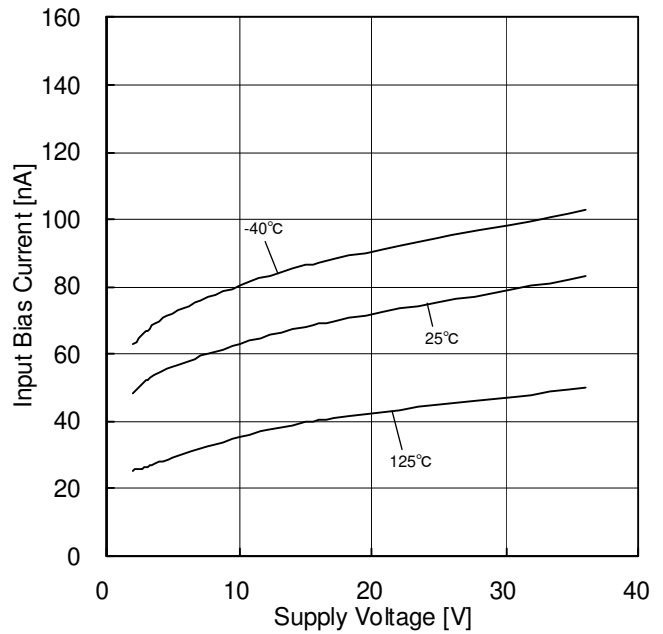

Figure 34.
Input Bias Current vs Supply Voltage

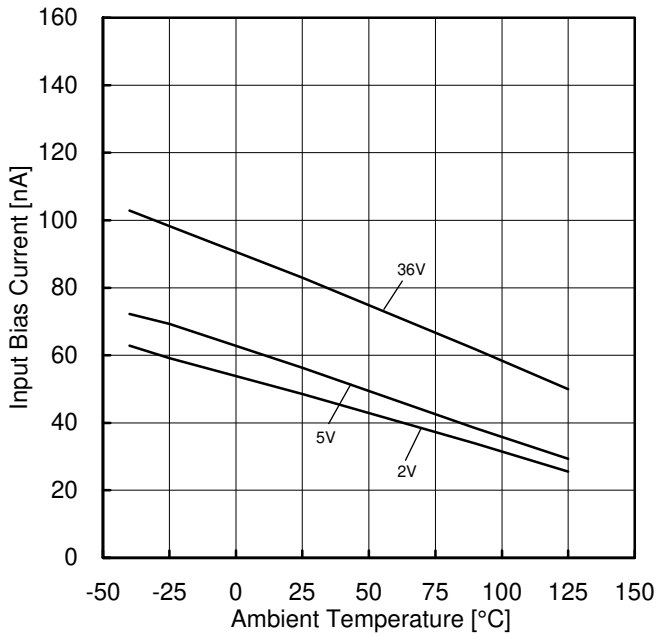

Figure 35.
Input Bias Current vs Ambient Temperature

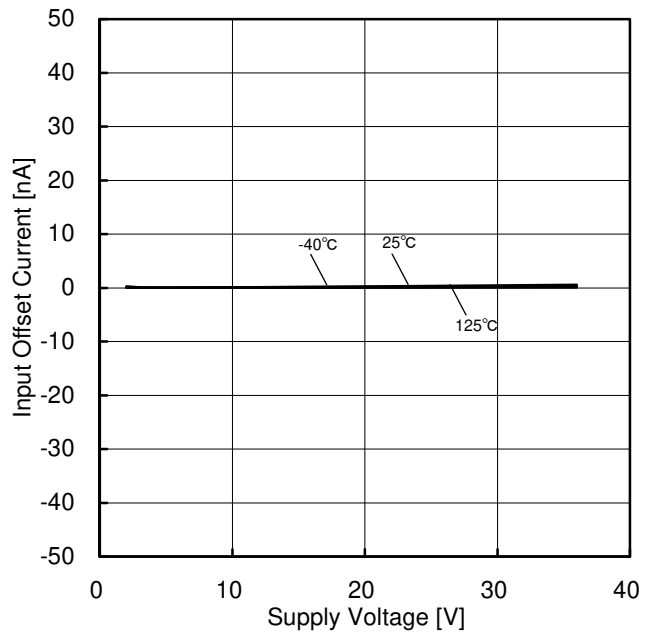

Figure 36.
Input Offset Current vs Supply Voltage

(*)The above characteristics are measurements of typical sample, they are not guaranteed.

Typical Performance Curves - continued

OBA2901Yxx-M

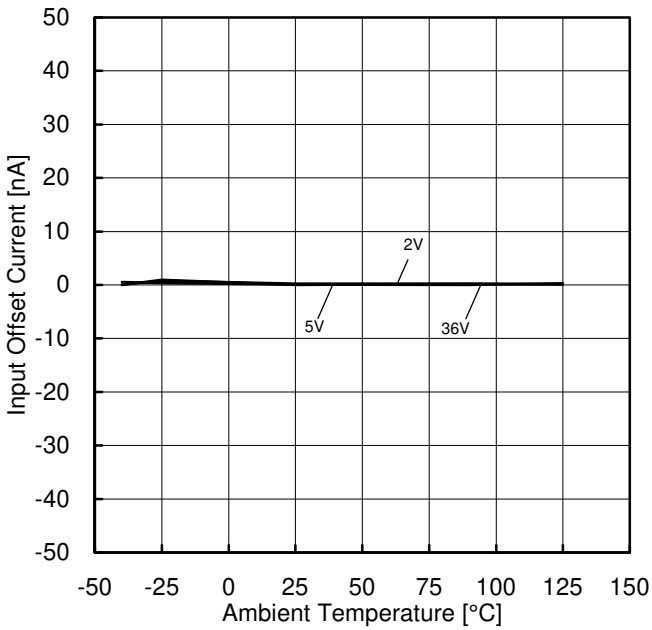

Figure 37.
Input Offset Current vs Ambient Temperature

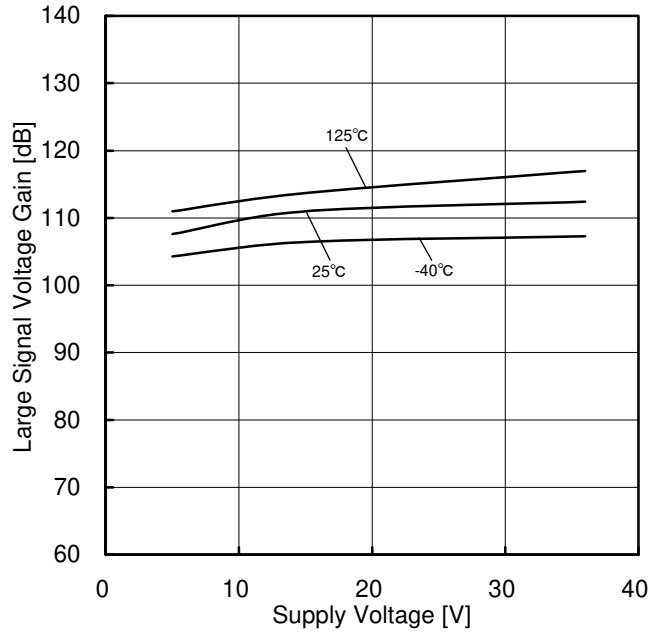

Figure 38.
Large Signal Voltage Gain vs Supply Voltage

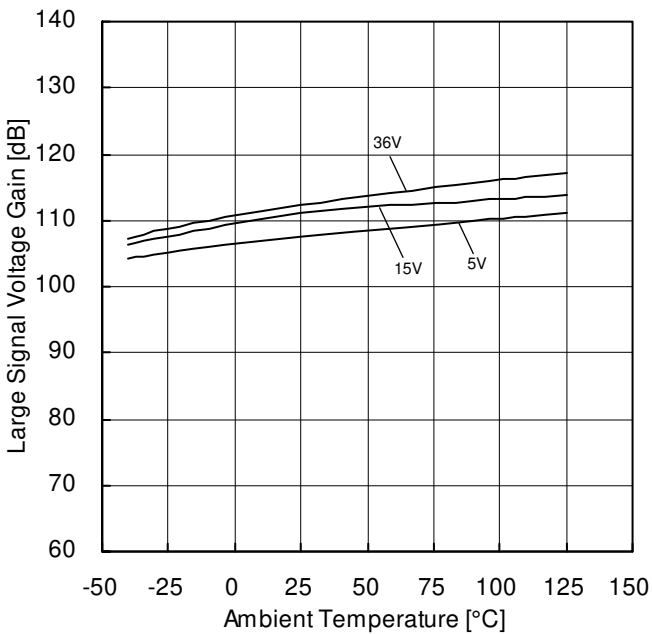

Figure 39.
Large Signal Voltage Gain vs Ambient Temperature

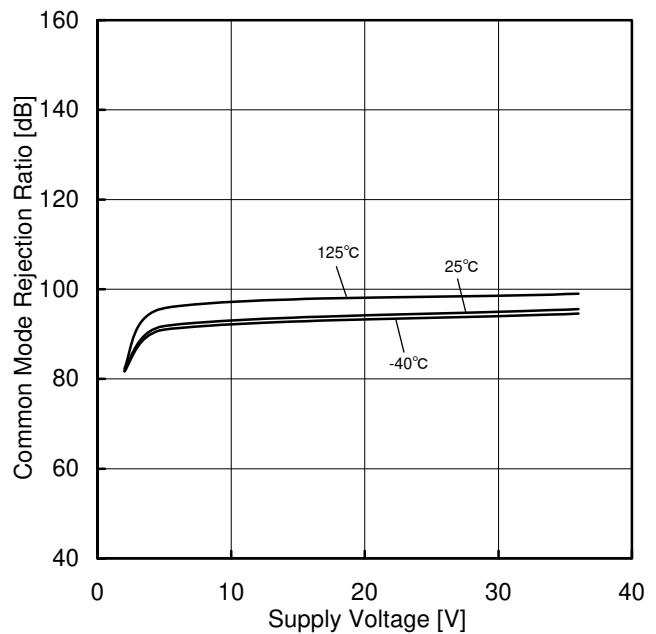

Figure 40.
Common Mode Rejection Ratio vs Supply Voltage

(*)The above characteristics are measurements of typical sample, they are not guaranteed.

Typical Performance Curves - continued

OBA2901Yxx-M

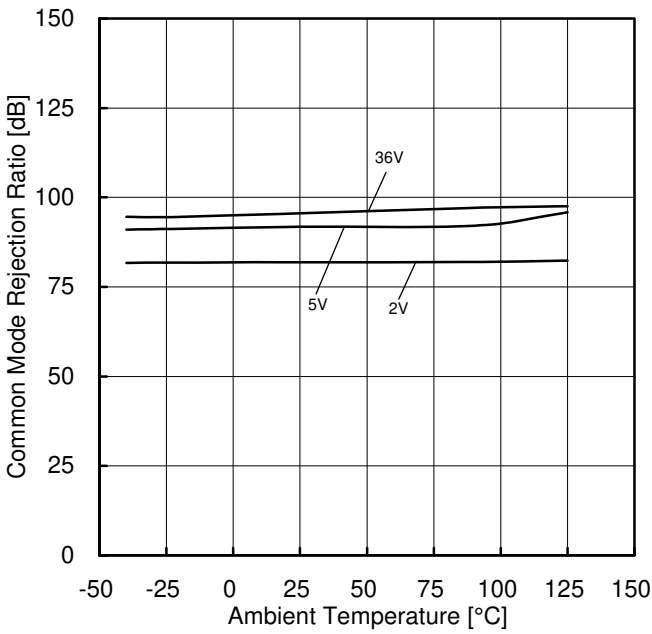

Figure 41.
Common Mode Rejection Ratio
vs Ambient Temperature

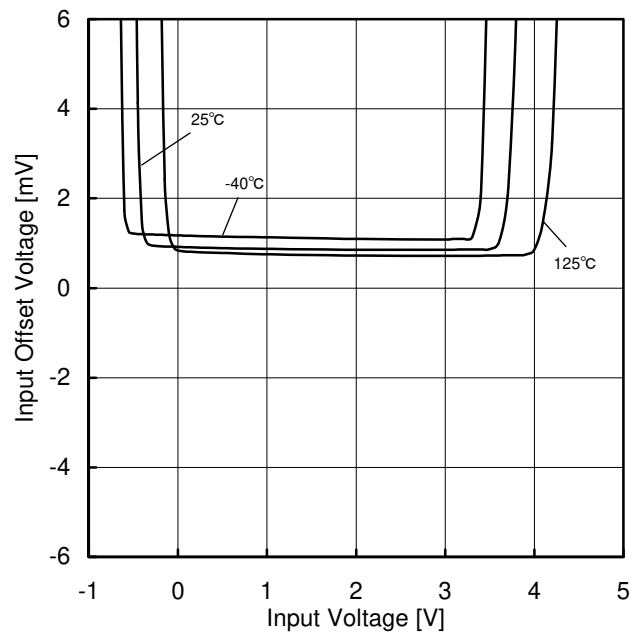

Figure 42.
Input Offset Voltage - Input Voltage
(VCC=5V)

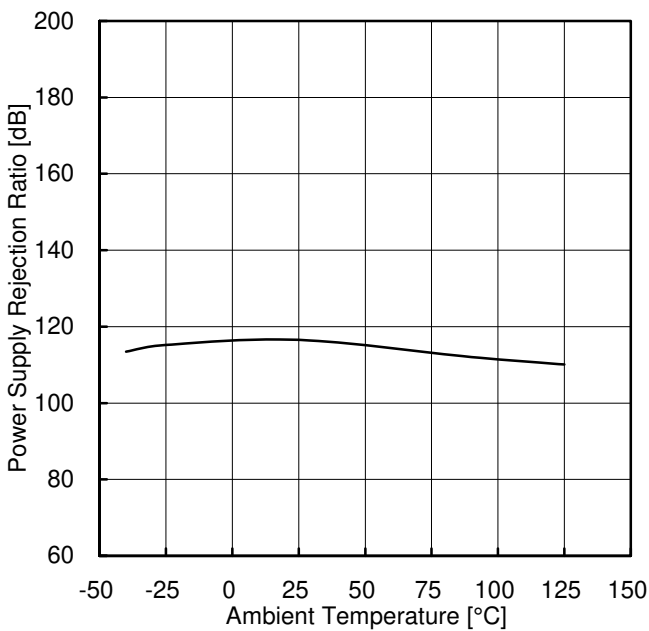

Figure 43.
Power Supply Rejection Ratio
vs Ambient Temperature

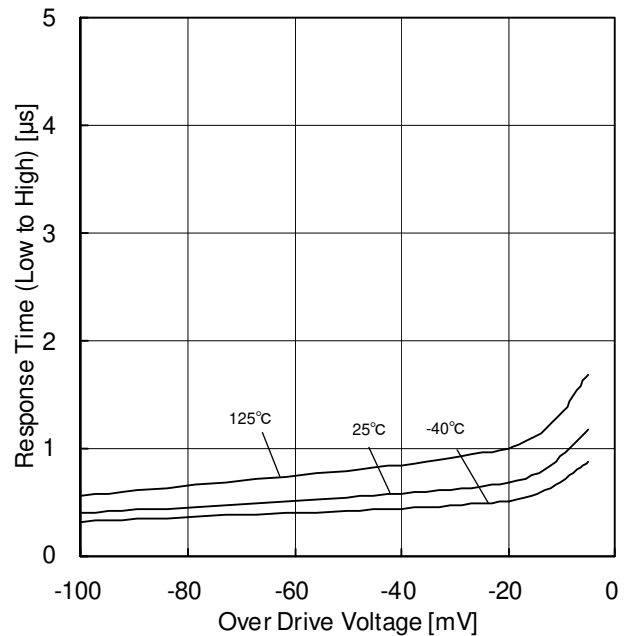

Figure 44.
Response Time (Low to High)
vs Over Drive Voltage
(VCC=5V, V_{RL}=5V, R_L=5.1kΩ)

(*)The above characteristics are measurements of typical sample, they are not guaranteed.

Typical Performance Curves - continued

OBA2901Yxx-M

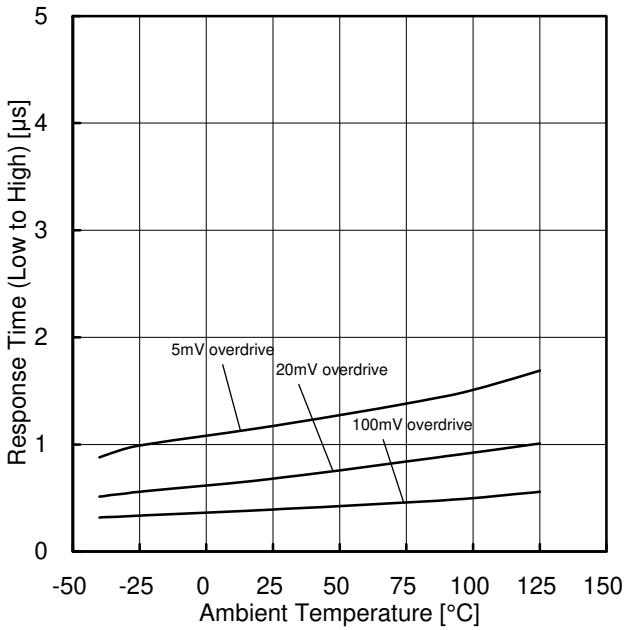

Figure 45.
Response Time (Low to High)
vs Ambient Temperature
(VCC=5V, V_{RL}=5V, R_L=5.1kΩ)

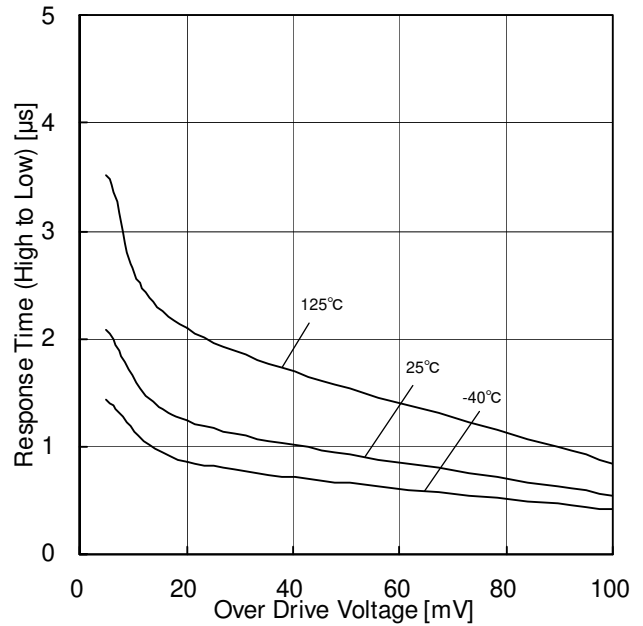

Figure 46.
Response Time (High to Low)
vs Over Drive Voltage
(VCC=5V, V_{RL}=5V, R_L=5.1kΩ)

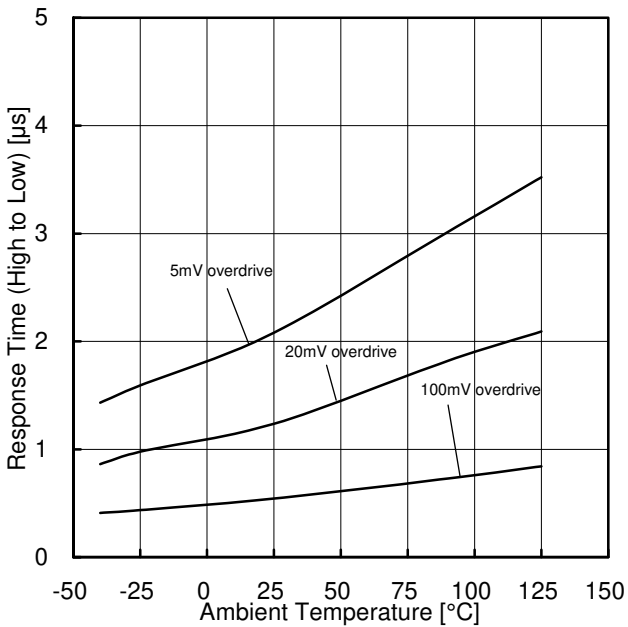

Figure 47.
Response Time (High to Low)
vs Ambient Temperature
(VCC=5V, V_{RL}=5V, R_L=5.1kΩ)

(*)The above characteristics are measurements of typical sample, they are not guaranteed.

Power Dissipation

Power dissipation (total loss) indicates the power that the IC can consume at $T_A=25^\circ\text{C}$ (normal temperature). As the IC consumes power, it heats up, causing its temperature to be higher than the ambient temperature. The allowable temperature that the IC can accept is limited. This depends on the circuit configuration, manufacturing process, and consumable power.

Power dissipation is determined by the allowable temperature within the IC (maximum junction temperature) and the thermal resistance of the package used (heat dissipation capability). Maximum junction temperature is typically equal to the maximum storage temperature. The heat generated through the consumption of power by the IC radiates from the mold resin or lead frame of the package. Thermal resistance, represented by the symbol $\theta_{JA}^\circ\text{C/W}$, indicates this heat dissipation capability. Similarly, the temperature of an IC inside its package can be estimated by thermal resistance.

Figure 48(a) shows the model of the thermal resistance of the package. The equation below shows how to compute for the Thermal resistance (θ_{JA}), given the ambient temperature (T_A), maximum junction temperature (T_{Jmax}), and power dissipation (P_D).

$$\theta_{JA} = (T_{Jmax} - T_A) / P_D \quad ^\circ\text{C/W}$$

The Derating curve in Figure 48(b) indicates the power that the IC can consume with reference to ambient temperature. Power consumption of the IC begins to attenuate at certain temperatures. This gradient is determined by Thermal resistance (θ_{JA}), which depends on the chip size, power consumption, package, ambient temperature, package condition, wind velocity, etc. This may also vary even when the same of package is used. Thermal reduction curve indicates a reference value measured at a specified condition. Figure 48(c) and (d) shows an example of the derating curve for BA2903Yxxx-M, BA2901Yxx-M.

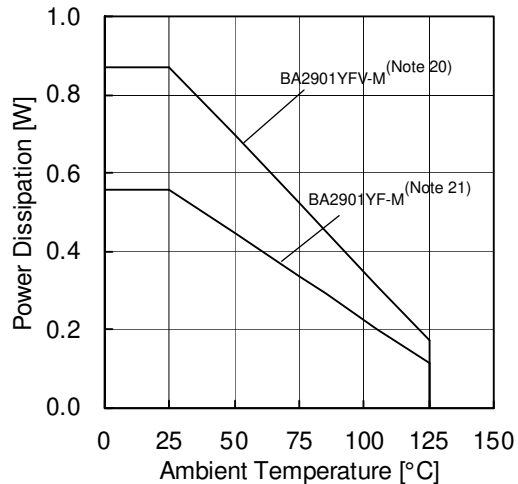
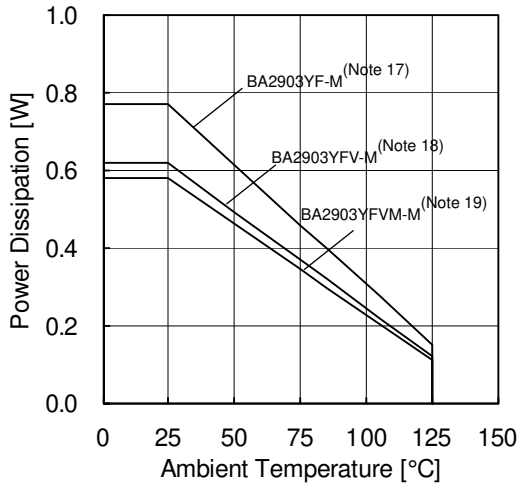
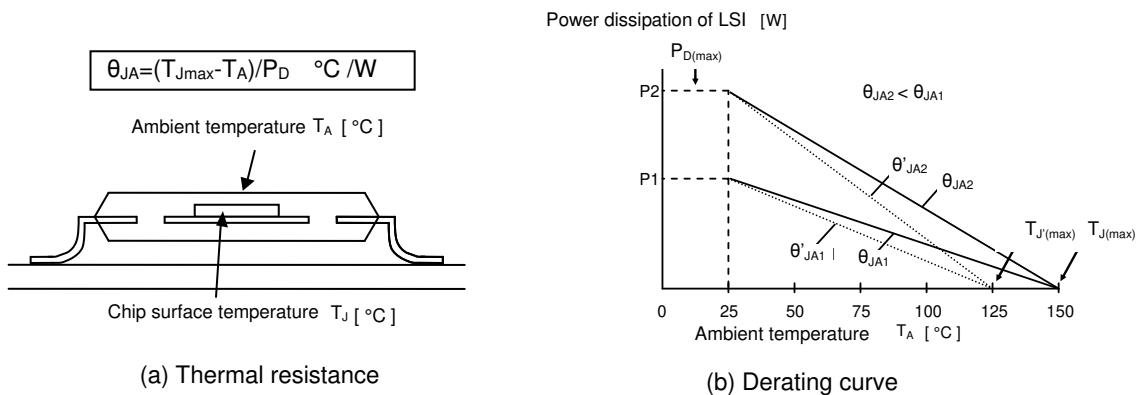

(Note17)	(Note18)	(Note19)	(Note20)	(Note21)	UNIT
6.2	5.0	4.7	7.0	4.5	mW/°C

When using the unit above $T_A=25^\circ\text{C}$, subtract the value above per Celsius degree.
Permissible dissipation is the value when FR4 glass epoxy board 70mm×70mm×1.6mm (copper foil area less than 3%) is mounted.

Figure 48. Thermal resistance and derating

Application Information

NULL method condition for Test circuit1

VCC,VEE,E_K,V_{ICM} Unit : V

Parameter	V _F	S1	S2	S3	VCC	VEE	E _K	V _{ICM}	Calculation
Input Offset Voltage	V _{F1}	ON	ON	ON	5 to 36	0	-1.4	0	1
Input Offset Current	V _{F2}	OFF	OFF	ON	5	0	-1.4	0	2
Input Bias Current	V _{F3}	OFF	ON	ON	5	0	-1.4	0	3
	V _{F4}	ON	OFF		5	0	-1.4	0	
Large Signal Voltage Gain	V _{F5}	ON	ON	ON	15	0	-1.4	0	4
	V _{F6}				15	0	-11.4	0	

- Calculation -

1. Input Offset Voltage (V_{IO})

$$V_{IO} = \frac{|V_{F1}|}{1+R_F/R_S} \text{ [V]}$$

2. Input Offset Current (I_{IO})

$$I_{IO} = \frac{|V_{F2}-V_{F1}|}{R_I \times (1+R_F/R_S)} \text{ [A]}$$

3. Input Bias Current (I_B)

$$I_B = \frac{|V_{F4}-V_{F3}|}{2 \times R_I \times (1+R_F/R_S)} \text{ [A]}$$

4. Large Signal Voltage Gain (A_V)

$$A_V = 20 \text{Log} \frac{\Delta E_K \times (1+R_F/R_S)}{|V_{F5}-V_{F6}|} \text{ [dB]}$$

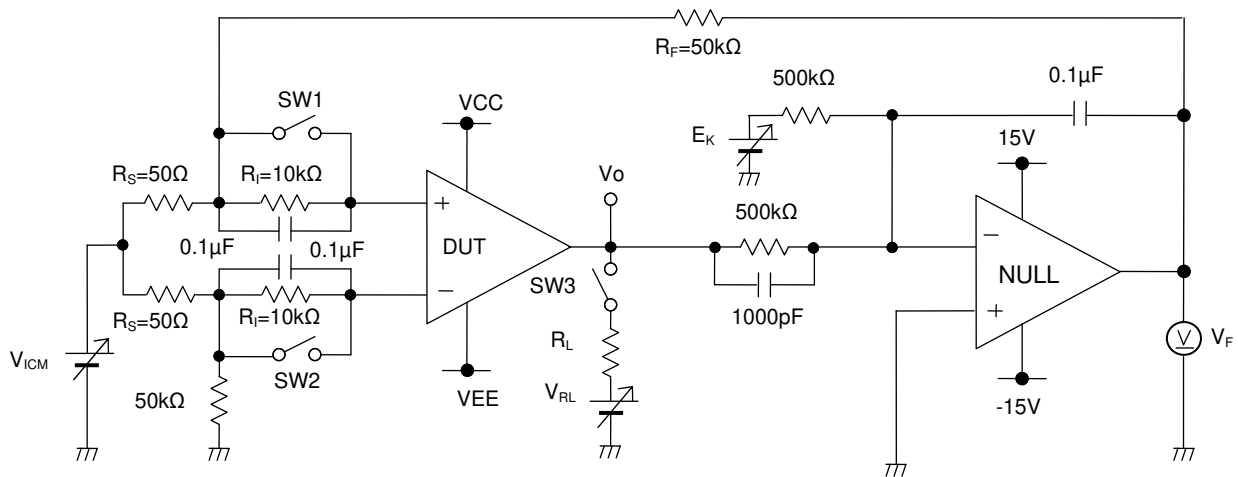

Figure 49. Test circuit1 (one channel only)

Switch Condition for Test Circuit 2

SW No.		SW 1	SW 2	SW 3	SW 4	SW 5	SW 6	SW 7
Supply Current		OFF	OFF	OFF	OFF	OFF	OFF	OFF
Output Sink Current	OUT=1.5V	OFF	ON	ON	OFF	OFF	OFF	ON
Output Saturation Voltage	ISINK=4mA	OFF	ON	ON	OFF	ON	ON	OFF
Output Leakage Current	OUT=36V	OFF	ON	ON	OFF	OFF	OFF	ON
Response Time	RL=5.1kΩ, VRL=5V	ON	OFF	ON	ON	OFF	OFF	OFF

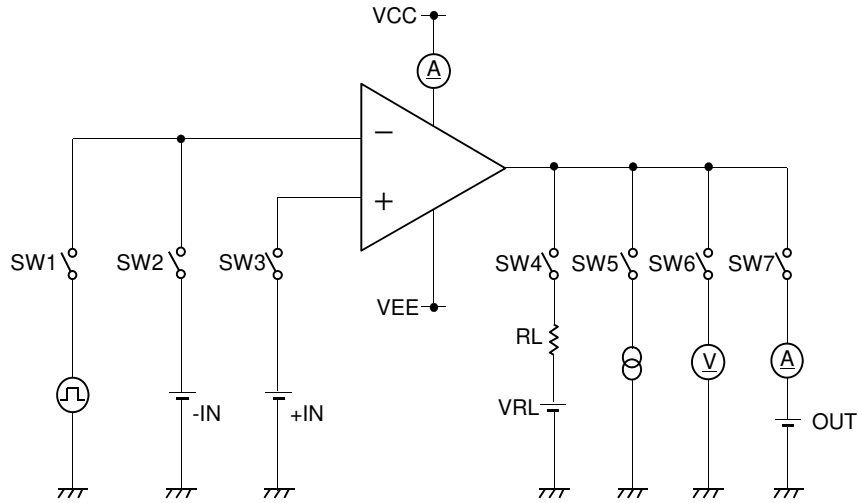

Figure 50. Test Circuit 2 (one channel only)

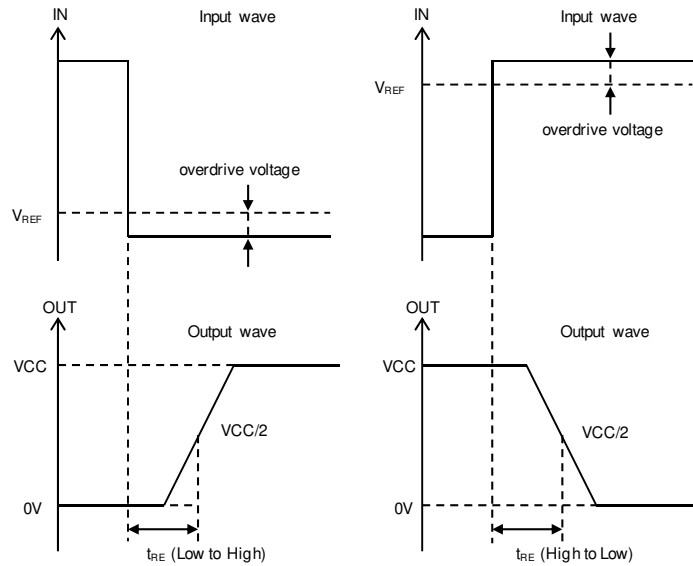
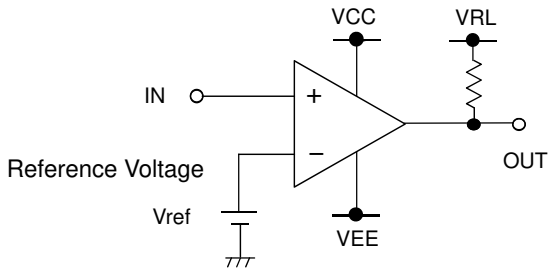

Figure 51. Response Time

Example of circuit

○Reference voltage is -IN



While the input voltage is higher than the reference voltage, the output voltage remains high. In case the input voltage becomes lower than the reference voltage, the output voltage will turn low.

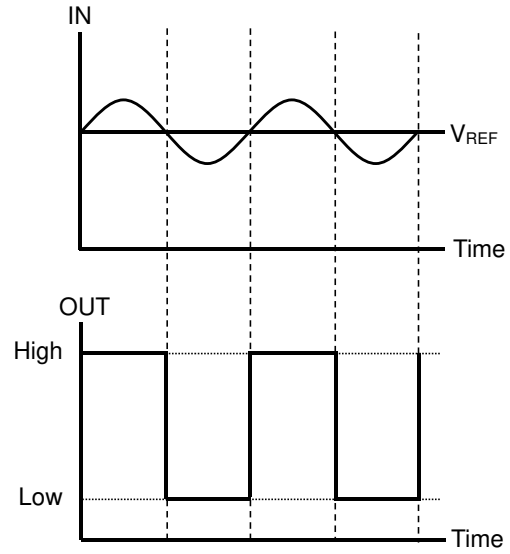

○Reference voltage is +IN

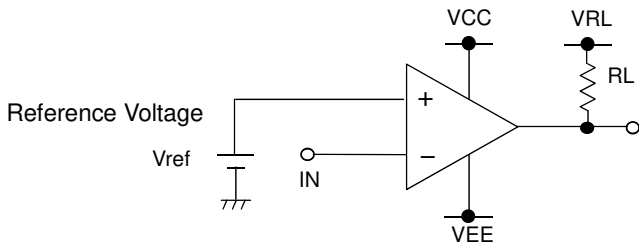

While the input voltage is smaller than the reference voltage, the output voltage remains high. In case the input voltage becomes higher than the reference voltage, the output voltage will turn low.

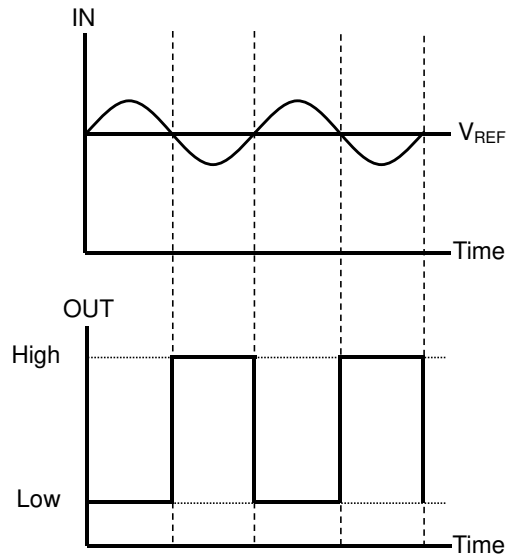

Operational Notes**1. Reverse Connection of Power Supply**

Connecting the power supply in reverse polarity can damage the IC. Take precautions against reverse polarity when connecting the power supply, such as mounting an external diode between the power supply and the IC's power supply terminals.

2. Power Supply Lines

Design the PCB layout pattern to provide low impedance ground and supply lines. Separate the ground and supply lines of the digital and analog blocks to prevent noise in the ground and supply lines of the digital block from affecting the analog block. Furthermore, connect a capacitor to ground at all power supply pins. Consider the effect of temperature and aging on the capacitance value when using electrolytic capacitors.

3. Ground Voltage

Ensure that no pins are at a voltage below that of the ground pin at any time, even during transient condition.

4. Ground Wiring Pattern

When using both small-signal and large-current GND traces, the two ground traces should be routed separately but connected to a single ground at the reference point of the application board to avoid fluctuations in the small-signal ground caused by large currents. Also ensure that the GND traces of external components do not cause variations on the GND voltage. The power supply and ground lines must be as short and thick as possible to reduce line impedance.

5. Thermal Consideration

Should by any chance the power dissipation rating be exceeded, the rise in temperature of the chip may result in deterioration of the properties of the chip. The absolute maximum rating of the Pd stated in this specification is when the IC is mounted on a 70mm x 70mm x 1.6mm glass epoxy board. In case of exceeding this absolute maximum rating, increase the board size and copper area to prevent exceeding the Pd rating.

6. Recommended Operating Conditions

These conditions represent a range within which the expected characteristics of the IC can be approximately obtained. The electrical characteristics are guaranteed under the conditions of each parameter.

7. Inrush Current

When power is first supplied to the IC, it is possible that the internal logic may be unstable and inrush current may flow instantaneously due to the internal powering sequence and delays, especially if the IC has more than one power supply. Therefore, give special consideration to power coupling capacitance, power wiring, width of GND wiring, and routing of connections.

8. Operation Under Strong Electromagnetic Field

Operating the IC in the presence of a strong electromagnetic field may cause the IC to malfunction.

9. Testing on Application Boards

When testing the IC on an application board, connecting a capacitor directly to a low-impedance output pin may subject the IC to stress. Always discharge capacitors completely after each process or step. The IC's power supply should always be turned off completely before connecting or removing it from the test setup during the inspection process. To prevent damage from static discharge, ground the IC during assembly and use similar precautions during transport and storage.

10. Inter-pin Short and Mounting Errors

Ensure that the direction and position are correct when mounting the IC on the PCB. Incorrect mounting may result in damaging the IC. Avoid nearby pins being shorted to each other especially to ground. Inter-pin shorts could be due to many reasons such as metal particles, water droplets (in very humid environment) and unintentional solder bridge deposited in between pins during assembly to name a few.

Operational Notes – continued

11. Regarding Input Pins of the IC

This monolithic IC contains P+ isolation and P substrate layers between adjacent elements in order to keep them isolated. P-N junctions are formed at the intersection of the P layers with the N layers of other elements, creating a parasitic diode or transistor. For example (refer to figure below):

- When $GND > Pin\ A$ and $GND > Pin\ B$, the P-N junction operates as a parasitic diode.
- When $GND > Pin\ B$, the P-N junction operates as a parasitic transistor.

Parasitic diodes inevitably occur in the structure of the IC. The operation of parasitic diodes can result in mutual interference among circuits, operational faults, or physical damage. Therefore, conditions that cause these diodes to operate, such as applying a voltage lower than the GND voltage to an input pin (and thus to the P substrate) should be avoided.

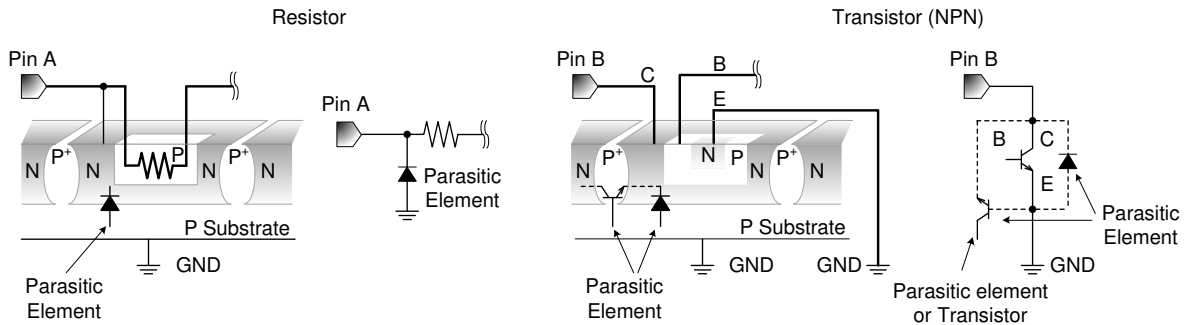

Figure 52. Example of Monolithic IC Structure

12. Unused Circuits

When there are unused circuits it is recommended that they be connected as in Figure 53, setting the non-inverting input terminal to a potential within the in-phase input voltage range (V_{ICM}).

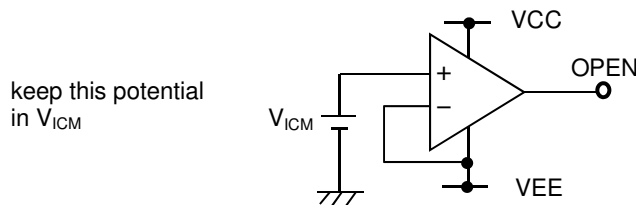

Figure 53. Disable Circuit Example

13. Input Terminal Voltage

Applying $VEE + 36V$ to the input terminal is possible without causing deterioration of the electrical characteristics or destruction, irrespective of the supply voltage. However, this does not ensure normal circuit operation. Please note that the circuit operates normally only when the input voltage is within the common mode input voltage range of the electric characteristics.

14. Power Supply (signal / dual)

The op-amp operates when the specified voltage supplied is between VCC and VEE. Therefore, the single supply op-amp can be used as a dual supply op-amp as well.

15. Terminal short-circuits

When the output and VCC terminals are shorted, excessive output current may flow, resulting in undue heat generation and, subsequently, destruction.

16. IC Handling

Applying mechanical stress to the IC by deflecting or bending the board may cause fluctuations in the electrical characteristics due to piezo resistance effects.

Physical Dimensions Tape and Reel Information

Package Name	SOP8
--------------	------

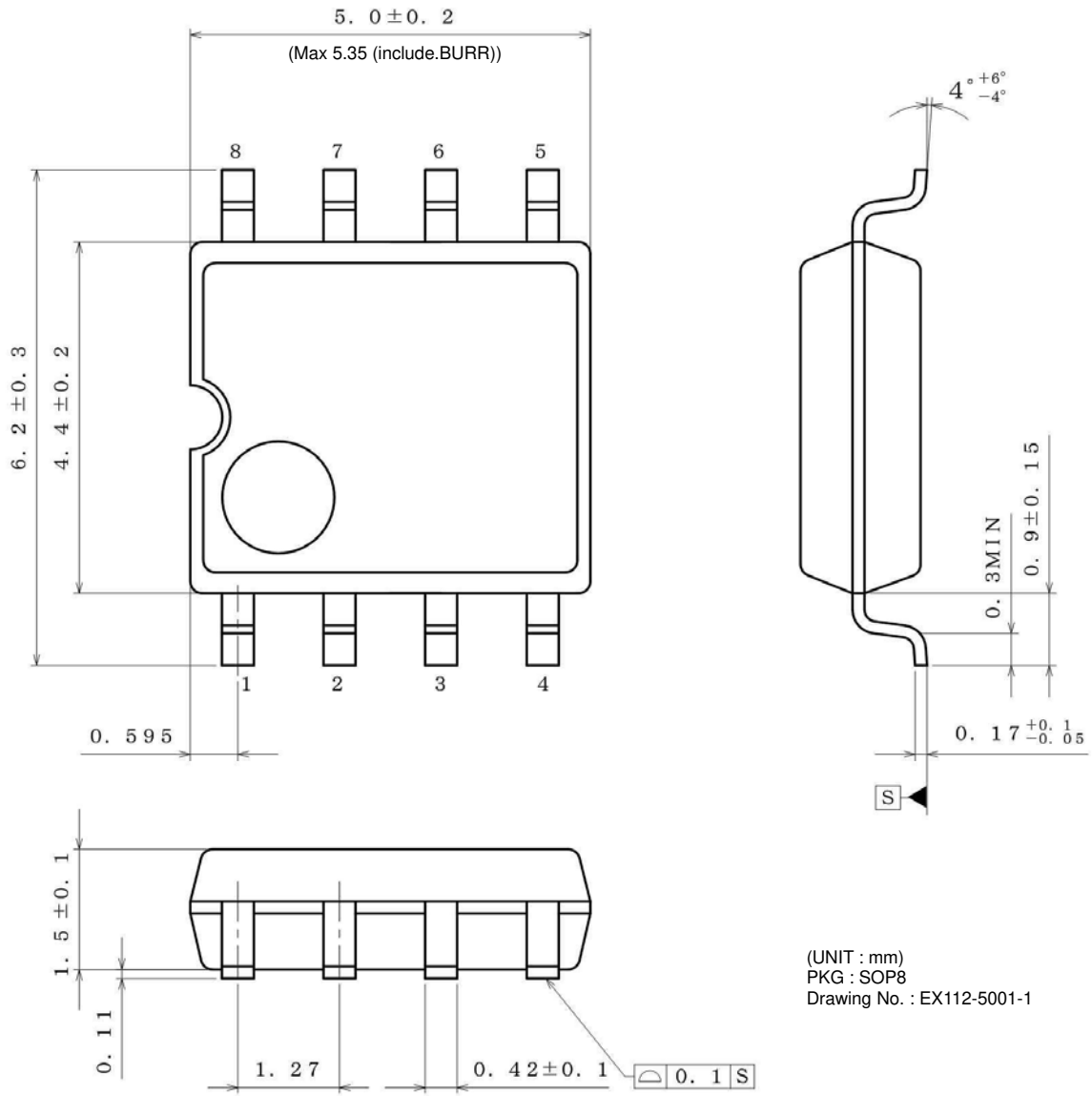

(UNIT : mm)
 PKG : SOP8
 Drawing No. : EX112-5001-1

