



Chipsmall Limited consists of a professional team with an average of over 10 year of expertise in the distribution of electronic components. Based in Hongkong, we have already established firm and mutual-benefit business relationships with customers from,Europe,America and south Asia,supplying obsolete and hard-to-find components to meet their specific needs.

With the principle of "Quality Parts,Customers Priority,Honest Operation,and Considerate Service",our business mainly focus on the distribution of electronic components. Line cards we deal with include Microchip,ALPS,ROHM,Xilinx,Pulse,ON,Everlight and Freescale. Main products comprise IC,Modules,Potentiometer,IC Socket,Relay,Connector.Our parts cover such applications as commercial,industrial, and automotives areas.

We are looking forward to setting up business relationship with you and hope to provide you with the best service and solution. Let us make a better world for our industry!



Contact us

Tel: +86-755-8981 8866 Fax: +86-755-8427 6832

Email & Skype: info@chipsmall.com Web: www.chipsmall.com

Address: A1208, Overseas Decoration Building, #122 Zhenhua RD., Futian, Shenzhen, China



Reversible Motor Drivers for Brush Motors

0.5A or Less Reversible Motor Driver (Single Motor)

BA6950FS



0.8A Reversible Motor Driver (Single Motor)

BA6951FS

No.11008ECT01

●Description

These drivers are reversible motor drivers that can directly drive brush motor which require forward and reverse rotations. Four modes of output setting are available by the use of input logic (2 inputs); forward, reverse, stop (idling), and braking. In addition, since voltage applied to motors varies in accord with the control terminal, motor rotating speed can be optionally set and by the built-in current feedback amplifier, the motor can be driven at a constant speed.

●Features

- 1) Four-mode outputs of forward, reverse, stop (idling), and braking are enabled in compliance with two inputs
- 2) Motors can be driven at a constant speed by a current feedback amplifier
- 3) Built-in thermal shutdown circuit
- 4) Built-in current limiting function (BA6951FS)

●Applications

Audio-visual equipment; PC peripherals; Car audios; Car navigation systems; OA equipments

●Absolute maximum ratings (Ta=25°C, All voltages are with respect to ground)

Parameter	Symbol	Ratings		Unit
		BA6950FS	BA6951FS	
Supply voltage	VCC	8		V
Supply voltage	VB	18		V
Output current	I _{OMAX}	0.4* ¹	0.8* ¹	A
Operating temperature	T _{OPR}	-20 ~ 75		°C
Storage temperature	T _{STG}	-55 ~ 150		°C
Power dissipation	Pd	0.813* ²		W
Junction temperature	T _{jmax}	150		°C

*1 Do not, exceed Pd or ASO.

*2 SSOP-A16 package. Mounted on a 70mm x 70mm x 1.6mm FR4 glass-epoxy board with less than 3% copper foil. Derated at 6.4mW/°C above 25°C.

●Operating conditions (Ta=25°C)

Parameter	Symbol	Ratings	Unit
Supply voltage	VCC	3 ~ 6	V
Supply voltage	VB	3 ~ 16	V
VTCL voltage	V _{CTL}	0 ~ (VCC-1.8)	V

● **Electrical characteristics** (BA6950FS, unless otherwise specified, Ta=25°C and VCC=4.8V, VB=4.8V)

Parameter	Symbol	Limits			Unit	Conditions
		Min.	Typ.	Max.		
Supply current 1	I _{CC1}	-	4.0	6.0	mA	FWD/REV mode, VCTL=0V
Supply current 2	I _{CC2}	-	0.7	1.5	mA	Standby mode, VCTL=0V
Supply current 3	I _{BOFF}	-	0	1	μA	VCC=0V
Input threshold voltage H	V _{R/FH}	2.0	-	VCC	V	
Input threshold voltage L	V _{R/FL}	0	-	0.8	V	
Input bias current	I _{R/FH}	-	80	135	μA	FIN=2V, RIN=2V
CTL amplifier offset voltage	V _{CTLOFS}	-5	0	5	mV	VCTL-RC, VCTL=0V, 1V
CTL amplifier gain	V _{CTLGA}	40	46	52	μA/V	ΔI _{RT1} , VCTL=2V, 1V
CTL output mirror ratio 1	I _{CTLR1}	0.85	1.00	1.15	ratio	I _{RT1} /I _{RC} , I _{RC} =20μA
CTL output mirror ratio 2	I _{CTLR2}	0.90	1.00	1.10	ratio	I _{RT1} /I _{RC} , I _{RC} =200μA
CS amplifier offset voltage	CS _{OFS}	-5	0	5	mV	CS1-CS2, CS1=0V, 0.1V
CS output mirror ratio 1	I _{CSR1}	0.85	1.00	1.15	ratio	I _{RT2} /I _{CS2} , I _{CS} =20μA
CS output mirror ratio 2	I _{CSR2}	0.90	1.00	1.10	ratio	I _{RT2} /I _{CS2} , I _{CS} =200μA
Output high voltage	V _H	2.0	4.6	-	V	M1, M2, VCTL=0.2V
Output saturation voltage H	V _{OH}	-	0.09	0.3	V	I _O =50mA, RT1=VCC
Output saturation voltage L	V _{OL}	-	0.07	0.2	V	I _O =50mA, RT1=VCC

● **Electrical characteristics** (BA6951FS, unless otherwise specified, Ta=25°C and VCC=4.8V, VB=4.8V)

Parameter	Symbol	Limits			Unit	Conditions
		Min.	Typ.	Max.		
Supply current 1	I _{CC1}	-	4.0	6.0	mA	FWD/REV mode, VCTL=0V
Supply current 2	I _{CC2}	-	0.7	1.5	mA	Standby mode, VCTL=0V
Supply current 3	I _{BOFF}	-	0	1	μA	VCC=0V
Input threshold voltage H	V _{R/FH}	2.0	-	VCC	V	
Input threshold voltage L	V _{R/FL}	0	-	0.8	V	
Input bias current	I _{R/FH}	-	80	135	μA	FIN=2V, RIN=2V
CTL amplifier offset voltage	V _{CTLOFS}	-5	0	5	mV	VCTL-RC, VCTL=0V, 1V
CTL amplifier gain	V _{CTLGA}	40	46	52	μA/V	ΔI _{RT1} , VCTL=2V, 1V
CTL output mirror ratio 1	I _{CTLR1}	0.85	1.00	1.15	ratio	I _{RT1} /I _{RC} , I _{RC} =20μA
CTL output mirror ratio 2	I _{CTLR2}	0.90	1.00	1.10	ratio	I _{RT1} /I _{RC} , I _{RC} =200μA
CS amplifier offset voltage	CS _{OFS}	-5	0	5	mV	ATC-CS, ATC=0V, 0.1V
CS output mirror ratio 1	I _{CSR1}	0.85	1.00	1.15	ratio	I _{RT2} /I _{CS} , I _{CS} =20μA
CS output mirror ratio 2	I _{CSR2}	0.90	1.00	1.10	ratio	I _{RT2} /I _{CS} , I _{CS} =200μA
TL-R _{AOFS} offset voltage	TL-R _{AOFS}	6	18	30	mV	TL=0.3V, R _{ATC} =1.0Ω
Output high voltage	V _H	1.85	2.20	2.55	V	M1, M2, VCTL=1.0V
Output saturation voltage H	V _{OH}	-	0.28	0.56	V	I _O =300mA, RT1=VCC
Output saturation voltage L	V _{OL}	-	0.32	0.64	V	I _O =300mA, RT1=VCC

●Electrical characteristic curves (Reference data)

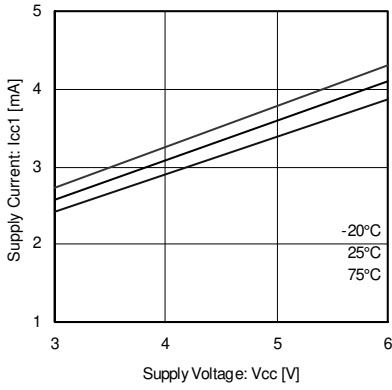

Fig.1 Supply current 1 (Forward) (BA6950FS)

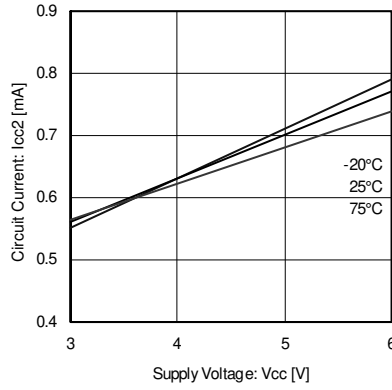

Fig.2 Supply current 2 (Standby) (BA6950FS)

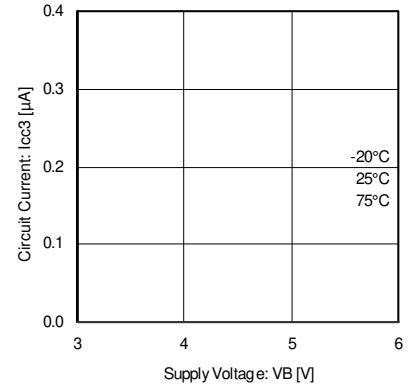

Fig.3 Supply current 3 (BA6950FS)

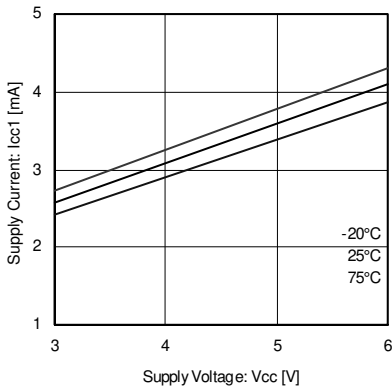

Fig.4 Supply current 1 (Forward) (BA6951FS)

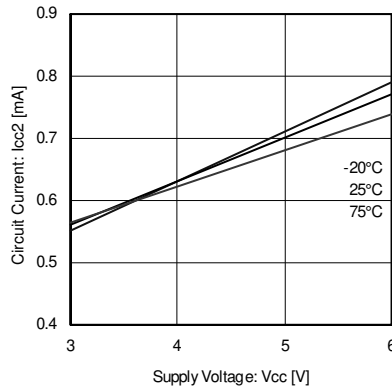

Fig.5 Supply current 2 (Standby) (BA6951FS)

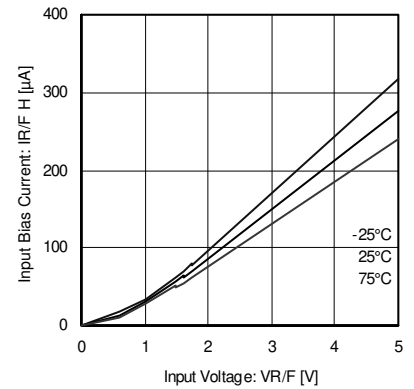

Fig.6 Input bias current (BA6950FS)

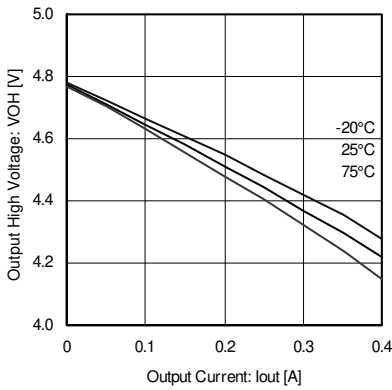

Fig.7 Output saturation voltage H (BA6950FS)

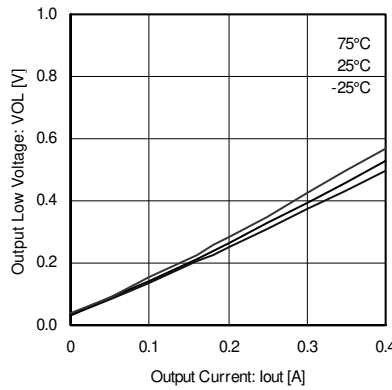

Fig.8 Output saturation voltage L (BA6950FS)

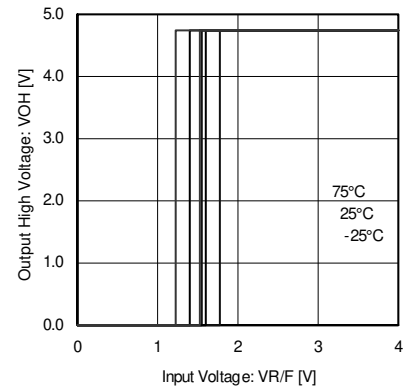

Fig.9 Input threshold voltage (BA6950FS)

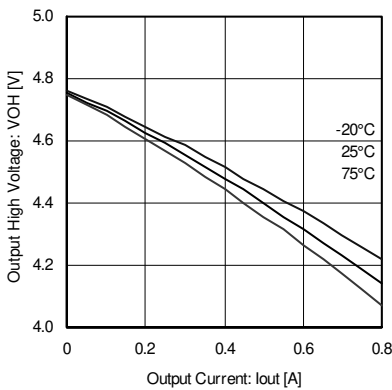

Fig.10 Output saturation voltage H (BA6951FS)

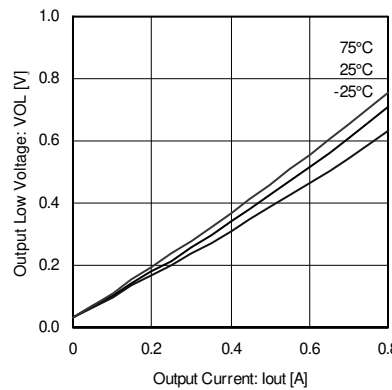

Fig.11 Output saturation voltage L (BA6951FS)

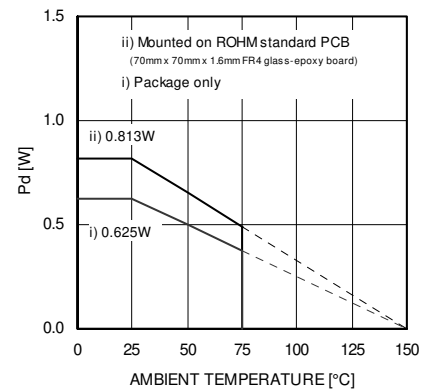

Fig.12 Thermal derating curve (SSOP-A16)

●Block diagram and pin configuration

BA6950FS

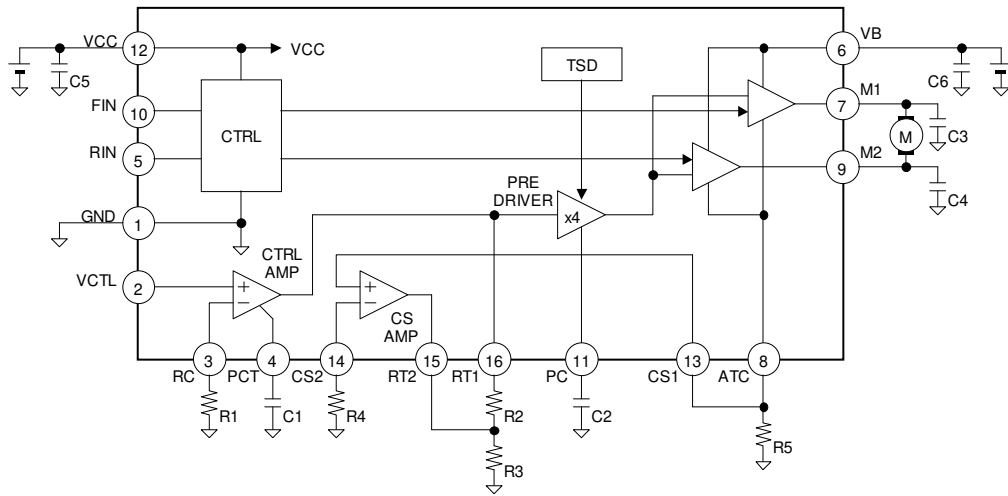

Fig.13 BA6950FS

Table 1 BA6950FS

Pin	Name	Function
1	GND	GND
2	VCTL	Control input
3	RC	Control gain setting
4	PCT	CTL amp phase compensation
5	RIN	Control input (reverse)
6	VB	Power supply (driver stage)
7	M1	Driver output
8	ATC	Current sense pin
9	M2	Driver output
10	FIN	Control input (forward)
11	PC	Phase compensation
12	VCC	Power supply (small signal)
13	CS1	CS amp gain setting
14	CS2	CS amp gain setting
15	RT2	CTL amp gain setting
16	RT1	CTL amp gain setting

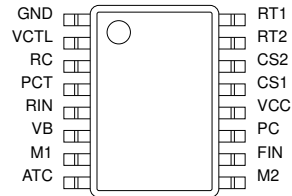

Fig.14 BA6950FS (SSOP-A16)

●Block diagram and pin configuration

BA6951FS

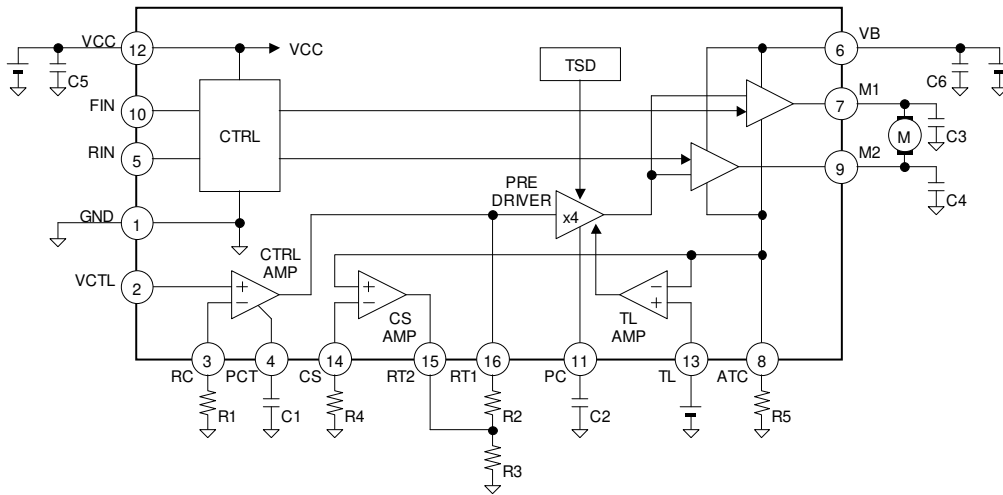

Fig.15 BA6951FS

Table 2 BA6951FS

Pin	Name	Function
1	GND	GND
2	VCTL	Control input
3	RC	Control gain setting
4	PCT	CTL amp phase compensation
5	RIN	Control input (reverse)
6	VB	Power supply (driver stage)
7	M1	Driver output
8	ATC	Current sense pin
9	M2	Driver output
10	FIN	Control input (forward)
11	PC	Phase compensation
12	VCC	Power supply (small signal)
13	TL	Torque limiter setting
14	CS	CS amp gain setting
15	RT2	CTL amp gain setting
16	RT1	CTL amp gain setting

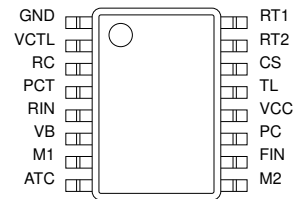

Fig.16 BA6951FS (SSOP-A16)

●External application components

- 1) Resistor for the current sensing, R5
This is a current sensing resistor, care must be taken to avoid changes in the ground wire pattern in any external connected component.
- 2) Control amplifier gain setting resistor, R1
VCTL pin voltage is buffered to RC pin, and the control gain - V_{CTLGA} - can be set by connecting R1. The current decided here is output to RT1 pin.
- 3) Control amplifier phase compensation capacitor, C1
This phase compensation capacitor for the control amplifier. Please monitor the RT1 pin voltage and confirm no oscillation. About 33pF is recommended.
- 4) Current feedback amplifier gain setting resistor, R4
CS1 pin voltage (the motor current detection) is buffered to CS2 pin - BA6950FS.
ATC pin voltage (the motor current detection) is buffered to CS pin - BA6951FS.
The current feedback gain can be set by R4 connecting to CS2 or CS pin. The current decided here is output to RT2 pin.
- 5) Pre-amplifier gain setting resistor, R2, R3
These resistors are to add the control amplifier output and the current feedback amplifier output. This amplifier has about fourfold gain.
- 6) Pre-amplifier phase compensation capacitor, C2
Please connect the capacitor about 0.1 μ F as the phase compensation of the pre-amplifier, and monitor the driver output no oscillation.
- 7) Stabilization capacitor for the power supply line, C5, C6
Please connect the capacitor of 1 μ F to 100 μ F for the stabilization of the power supply line, and confirm the motor operation.
- 8) Phase compensating capacitor, C3, C4
Noise is generated in output pins or oscillation results in accord with the set mounting state such as power supply circuit, motor characteristics, PCB pattern artwork, etc. As noise oscillation measures, connect 0.01 μ F to 0.1 μ F capacitors.
- 9) Torque limiter setting, TL pin, BA6951FS only
The motor current is limited so that ATC pin voltage should not exceed TL pin voltage.

●Functional descriptions

Table 3 Logic table

FIN	RIN	M1	M2	Operation
L	L	OPEN*	OPEN*	Stop (idling)
H	L	L	H	Forward ($M2 > M1$)
L	H	H	L	Reverse ($M1 > M2$)
H	H	L	L	Brake (stop)

* OPEN is the off state of all output transistors. Please note that this is the state of the connected diodes, which differs from that of the mechanical relay.

●External application components setting procedure

The relation between VCTL and the output high voltage is as follows.

- $I_{RT1} = VCTL / R1$ (1) VCTL: Torque control voltage
- $I_{RT2} = I_{ACT} \times R5 / R4$ (2) I_{ACT} : Motor current
- $V_{RT1} = R3 \times (I_{RT1} + I_{RT2}) + R2 \times I_{RT1}$ (3)
- $V_{MX} = 4 \times V_{RT1}$ (4) V_{M1}, V_{M2} : Output high voltage

$$V_{MX} = \frac{4 (R2 + R3)}{R1} \times VCTL + \frac{4 R3 R5}{R4} \times I_{ACT} \quad \dots (5)$$

To drive the motor by constant speed as follows.

$$R_L + R_{ON} + R5 = \frac{4 R3 R5}{R4} \quad \dots (6) \quad \begin{matrix} R_L: \text{Motor coil impedance} \\ R_{ON}: \text{On resistance of the driver IC} \end{matrix}$$

R3, R4, and R5 are first set, and then R1 and R2 are set afterwards.

Table 4 External components

Parts	Default value	Parameter	Recommended condition
R1	22kΩ	I_{RT1}	$I_{RT1} < 1\text{mA}$
R2 + R3	1kΩ + 1.5kΩ	V_{RT1}	$V_{RT1} \times 4 < V_B$
R4	560Ω	I_{RT2}	$I_{RT2} < 1\text{mA}$
R5	5.5Ω	V_{ATC}	$V_{ATC} < 1\text{V}$
C1	33pF	V_{PCT}	Please confirm the motor operation
C2	0.1μF	V_{PC}	
C3, C4	0.1μF	V_{M1}, V_{M2}	
C5, C6	1~100μF	V_{CC}, V_B	

●Interfaces

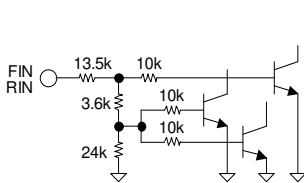

Fig. 17 FIN, RIN

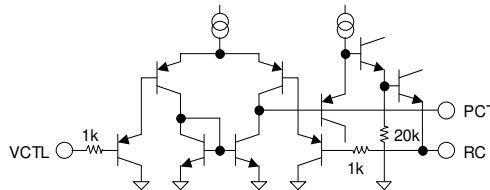

Fig.18 VCTL, RC, PCT

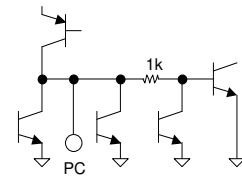

Fig.19 PC

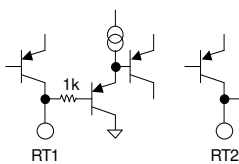

Fig. 20 RT1, RT2

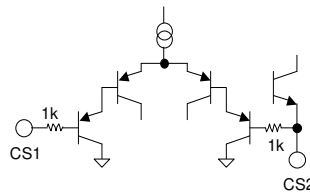

Fig.21 CS1, CS2 (BA6950FS)

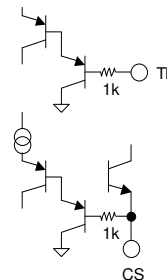

Fig.22 CS, TL (BA6951FS)

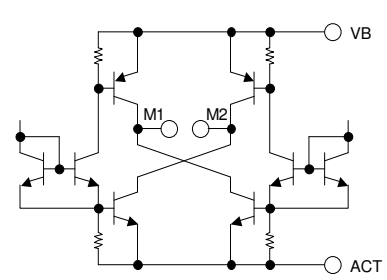

Fig.23 VB, ACT, M1, M2

●Notes for use

- 1) **Absolute maximum ratings**
Devices may be destroyed when supply voltage or operating temperature exceeds the absolute maximum rating. Because the cause of this damage cannot be identified as, for example, a short circuit or an open circuit, it is important to consider circuit protection measures – such as adding fuses – if any value in excess of absolute maximum ratings is to be implemented.
- 2) **Connecting the power supply connector backward**
Connecting the power supply in reverse polarity can damage the IC. Take precautions against reverse polarity when connecting the power supply lines, such as adding an external direction diode.
- 3) **Power supply lines**
Return current generated by the motor's Back-EMF requires countermeasures, such as providing a return current path by inserting capacitors across the power supply and GND (10 μ F, ceramic capacitor is recommended). In this case, it is important to conclusively confirm that none of the negative effects sometimes seen with electrolytic capacitors – including a capacitance drop at low temperatures - occurs. Also, the connected power supply must have sufficient current absorbing capability. Otherwise, the regenerated current will increase voltage on the power supply line, which may in turn cause problems with the product, including peripheral circuits exceeding the absolute maximum rating. To help protect against damage or degradation, physical safety measures should be taken, such as providing a voltage clamping diode across the power supply and GND.
- 4) **Electrical potential at GND**
Keep the GND terminal potential to the minimum potential under any operating condition. In addition, check to determine whether there is any terminal that provides voltage below GND, including the voltage during transient phenomena. When both a small signal GND and high current GND are present, single-point grounding (at the set's reference point) is recommended, in order to separate the small signal and high current GND, and to ensure that voltage changes due to the wiring resistance and high current do not affect the voltage at the small signal GND. In the same way, care must be taken to avoid changes in the GND wire pattern in any external connected component.
- 5) **Thermal design**
Use a thermal design that allows for a sufficient margin in light of the power dissipation (Pd) under actual operating conditions.
- 6) **Inter-pin shorts and mounting errors**
Use caution when positioning the IC for mounting on printed circuit boards. The IC may be damaged if there is any connection error, or if pins are shorted together.
- 7) **Operation in strong electromagnetic fields**
Using this product in strong electromagnetic fields may cause IC malfunctions. Use extreme caution with electromagnetic fields.
- 8) **ASO - Area of Safety Operation**
When using the IC, set the output transistor so that it does not exceed absolute maximum ratings or ASO.
- 9) **Built-in thermal shutdown (TSD) circuit**
The TSD circuit is designed only to shut the IC off to prevent thermal runaway. It is not designed to protect the IC or guarantee its operation in the presence of extreme heat. Do not continue to use the IC after the TSD circuit is activated, and do not operate the IC in an environment where activation of the circuit is assumed.
- 10) **Capacitor between output and GND**
In the event a large capacitor is connected between the output and GND, if VCC and VIN are short-circuited with 0V or GND for any reason, the current charged in the capacitor flows into the output and may destroy the IC. Use a capacitor smaller than 0.47 μ F between output and GND.
- 11) **Testing on application boards**
When testing the IC on an application board, connecting a capacitor to a low impedance pin subjects the IC to stress. Therefore, always discharge capacitors after each process or step. Always turn the IC's power supply off before connecting it to or removing it from the test setup during the inspection process. Ground the IC during assembly steps as an antistatic measure. Use similar precaution when transporting or storing the IC.
- 12) **Switching of rotating direction (FWD/REV)**
When the rotating direction is changed over by the motor rotating condition, switch the direction after the motor is temporarily brought to the BRAKE condition or OPEN condition. It is recommended to keep the relevant conditions as follows: via BRAKE: Longer than braking time*.
(* the time required for the output voltage to achieve potential below GND when brake is activated.)
via OPEN: The time longer than 1 ms is recommended.

13) Regarding the input pin of the IC

This monolithic IC contains P+ isolation and P substrate layers between adjacent elements, in order to keep them isolated. P-N junctions are formed at the intersection of these P layers with the N layers of other elements, creating a parasitic diode or transistor.

For example, the relation between each potential is as follows:
 When $GND > Pin A$ and $GND > Pin B$, the P-N junction operates as a parasitic diode.

When $GND > Pin B$, the P-N junction operates as a parasitic transistor.

Parasitic diodes inevitably occur in the structure of the IC. The operation of parasitic diodes can result in mutual interference among circuits, as well as operating malfunctions and physical damage. Therefore, do not use methods by which parasitic diodes operate, such as applying a voltage lower than the GND (P substrate) voltage to an input pin.

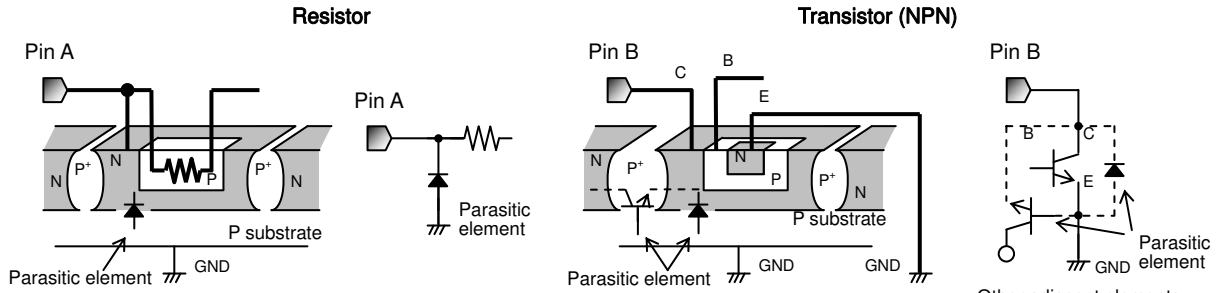

Appendix: Example of monolithic IC structure

●Ordering part number

B	A
---	---

Part No.

6	9	5	0
---	---	---	---

Part No.
6950
6951

F	S
---	---

Package
FS: SSOP-A16

E	2
---	---

Packaging and forming specification
E2: Embossed tape and reel

SSOP-A16

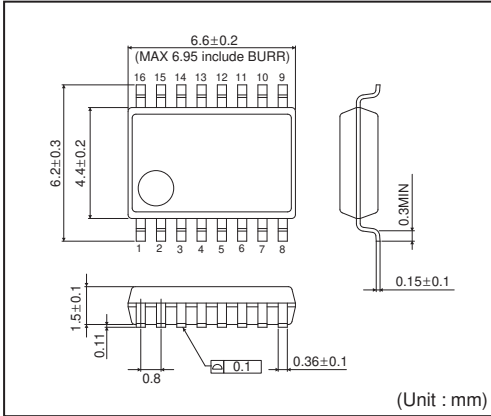

<Tape and Reel information>

Tape	Embossed carrier tape
Quantity	2500pcs
Direction of feed	E2 (The direction is the 1 pin of product is at the upper left when you hold reel on the left hand and you pull out the tape on the right hand)

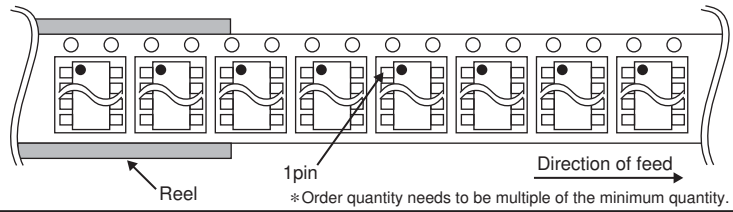

Notes

No copying or reproduction of this document, in part or in whole, is permitted without the consent of ROHM Co.,Ltd.

The content specified herein is subject to change for improvement without notice.

The content specified herein is for the purpose of introducing ROHM's products (hereinafter "Products"). If you wish to use any such Product, please be sure to refer to the specifications, which can be obtained from ROHM upon request.

Examples of application circuits, circuit constants and any other information contained herein illustrate the standard usage and operations of the Products. The peripheral conditions must be taken into account when designing circuits for mass production.

Great care was taken in ensuring the accuracy of the information specified in this document. However, should you incur any damage arising from any inaccuracy or misprint of such information, ROHM shall bear no responsibility for such damage.

The technical information specified herein is intended only to show the typical functions of and examples of application circuits for the Products. ROHM does not grant you, explicitly or implicitly, any license to use or exercise intellectual property or other rights held by ROHM and other parties. ROHM shall bear no responsibility whatsoever for any dispute arising from the use of such technical information.

The Products specified in this document are intended to be used with general-use electronic equipment or devices (such as audio visual equipment, office-automation equipment, communication devices, electronic appliances and amusement devices).

The Products specified in this document are not designed to be radiation tolerant.

While ROHM always makes efforts to enhance the quality and reliability of its Products, a Product may fail or malfunction for a variety of reasons.

Please be sure to implement in your equipment using the Products safety measures to guard against the possibility of physical injury, fire or any other damage caused in the event of the failure of any Product, such as derating, redundancy, fire control and fail-safe designs. ROHM shall bear no responsibility whatsoever for your use of any Product outside of the prescribed scope or not in accordance with the instruction manual.

The Products are not designed or manufactured to be used with any equipment, device or system which requires an extremely high level of reliability the failure or malfunction of which may result in a direct threat to human life or create a risk of human injury (such as a medical instrument, transportation equipment, aerospace machinery, nuclear-reactor controller, fuel-controller or other safety device). ROHM shall bear no responsibility in any way for use of any of the Products for the above special purposes. If a Product is intended to be used for any such special purpose, please contact a ROHM sales representative before purchasing.

If you intend to export or ship overseas any Product or technology specified herein that may be controlled under the Foreign Exchange and the Foreign Trade Law, you will be required to obtain a license or permit under the Law.



Thank you for your accessing to ROHM product informations.
More detail product informations and catalogs are available, please contact us.

ROHM Customer Support System

<http://www.rohm.com/contact/>