



Chipsmall Limited consists of a professional team with an average of over 10 year of expertise in the distribution of electronic components. Based in Hongkong, we have already established firm and mutual-benefit business relationships with customers from,Europe,America and south Asia,supplying obsolete and hard-to-find components to meet their specific needs.

With the principle of “Quality Parts,Customers Priority,Honest Operation,and Considerate Service”,our business mainly focus on the distribution of electronic components. Line cards we deal with include Microchip,ALPS,ROHM,Xilinx,Pulse,ON,Everlight and Freescale. Main products comprise IC,Modules,Potentiometer,IC Socket,Relay,Connector.Our parts cover such applications as commercial,industrial, and automotives areas.

We are looking forward to setting up business relationship with you and hope to provide you with the best service and solution. Let us make a better world for our industry!



Contact us

Tel: +86-755-8981 8866 Fax: +86-755-8427 6832

Email & Skype: info@chipsmall.com Web: www.chipsmall.com

Address: A1208, Overseas Decoration Building, #122 Zhenhua RD., Futian, Shenzhen, China



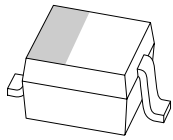

BAP50-03

General purpose PIN diode

Rev. 04 — 11 September 2009

Product data sheet

1. Product profile

1.1 General description

General purpose PIN diode in a SOD323 small plastic SMD package.

1.2 Features



- Low diode capacitance
- Low diode forward resistance

1.3 Applications

- General RF application

2. Pinning information

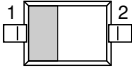
Table 1. Discrete pinning

Pin	Description	Simplified outline	Graphic symbol
1	cathode		 <i>sym006</i>
2	anode		

3. Ordering information

Table 2. Ordering information

Type number	Package		
	Name	Description	Version
BAP50-03	SC-76	plastic surface-mounted package; 2 leads	SOD323

4. Limiting values

Table 3. Limiting values

In accordance with the Absolute Maximum Rating System (IEC 60134).

Symbol	Parameter	Conditions	Min	Max	Unit
Per diode					
V_R	reverse voltage		-	50	V
I_F	forward current		-	50	mA
P_{tot}	total power dissipation	$T_{sp} = 90\text{ °C}$	-	500	mW
T_{stg}	storage temperature		-65	+150	°C
T_j	junction temperature		-65	+150	°C

5. Thermal characteristics

Table 4. Thermal characteristics

Symbol	Parameter	Conditions	Typ	Unit
$R_{th(j-sp)}$	thermal resistance from junction to soldering point		85	K/W

6. Characteristics

Table 5. Characteristics

$T_j = 25\text{ °C}$ unless otherwise specified.

Symbol	Parameter	Conditions	Min	Typ	Max	Unit	
V_F	forward voltage	$I_F = 50\text{ mA}$	-	0.95	1.1	V	
V_R	reverse voltage	$I_R = 10\text{ }\mu\text{A}$	50	-	-	V	
I_R	reverse current	$V_R = 50\text{ V}$	-	-	100	nA	
C_d	diode capacitance	$f = 1\text{ MHz}$; see Figure 1					
		$V_R = 0\text{ V}$	-	0.4	-	pF	
		$V_R = 1\text{ V}$	-	0.3	0.55	pF	
		$V_R = 5\text{ V}$	-	0.2	0.35	pF	
r_D	diode forward resistance	$f = 100\text{ MHz}$; see Figure 2					
		$I_F = 0.5\text{ mA}$	[1]	-	25	40	Ω
		$I_F = 1\text{ mA}$	[1]	-	14	25	Ω
		$I_F = 10\text{ mA}$	[1]	-	3	5	Ω

[1] Guaranteed on AQL basis: inspection level S4, AQL 1.0.

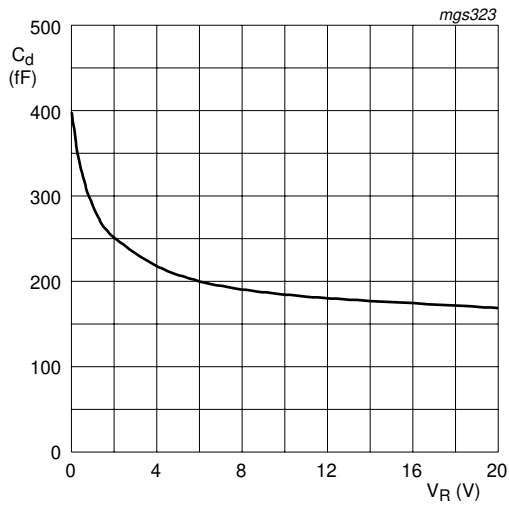

$f = 1 \text{ MHz}; T_j = 25 \text{ }^\circ\text{C}.$

Fig 1. Diode capacitance as a function of reverse voltage; typical values

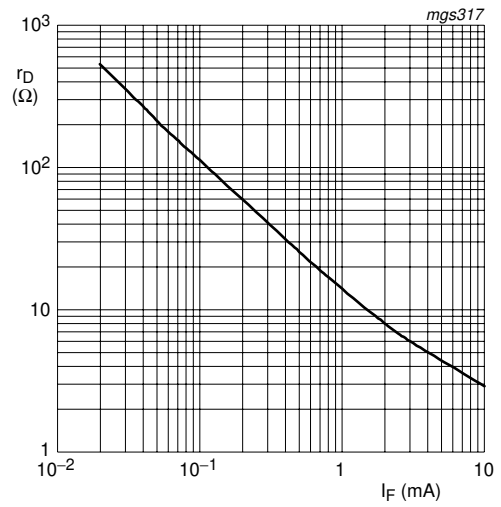

$f = 100 \text{ MHz}; T_j = 25 \text{ }^\circ\text{C}.$

Fig 2. Diode forward resistance as a function of forward current; typical values

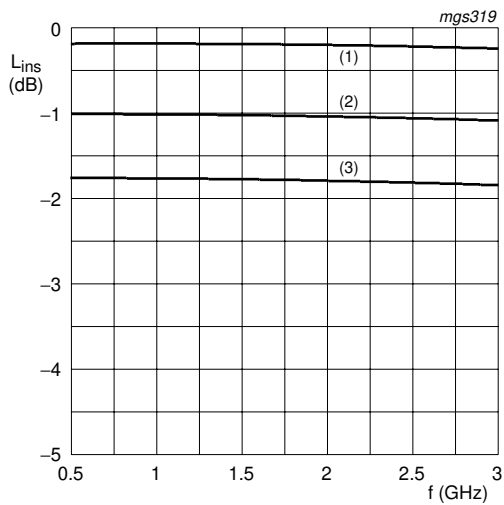

- (1) $I_F = 10 \text{ mA}$
 - (2) $I_F = 1 \text{ mA}$
 - (3) $I_F = 0.5 \text{ mA}$
- $T_{amb} = 25 \text{ }^\circ\text{C}.$

Diode inserted in series with a $50 \text{ } \Omega$ stripline circuit and biased via the analyzer Tee network.

Fig 3. Insertion loss of the diode as a function of frequency; typical values

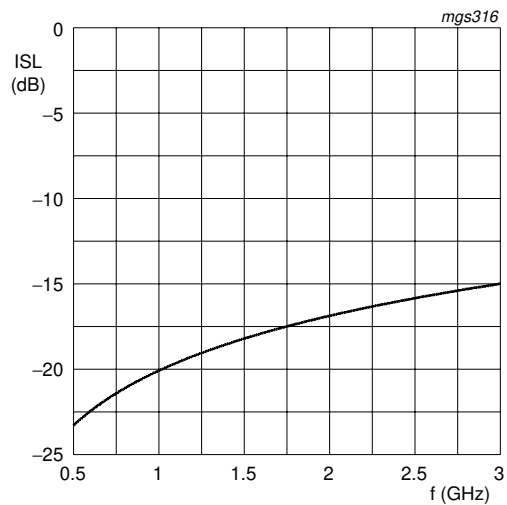

$T_{amb} = 25 \text{ }^\circ\text{C}.$

Diode zero biased and inserted in series with a $50 \text{ } \Omega$ stripline circuit.

Fig 4. Isolation of the diode as a function of frequency; typical values

7. Package outline

Plastic surface-mounted package; 2 leads

SOD323

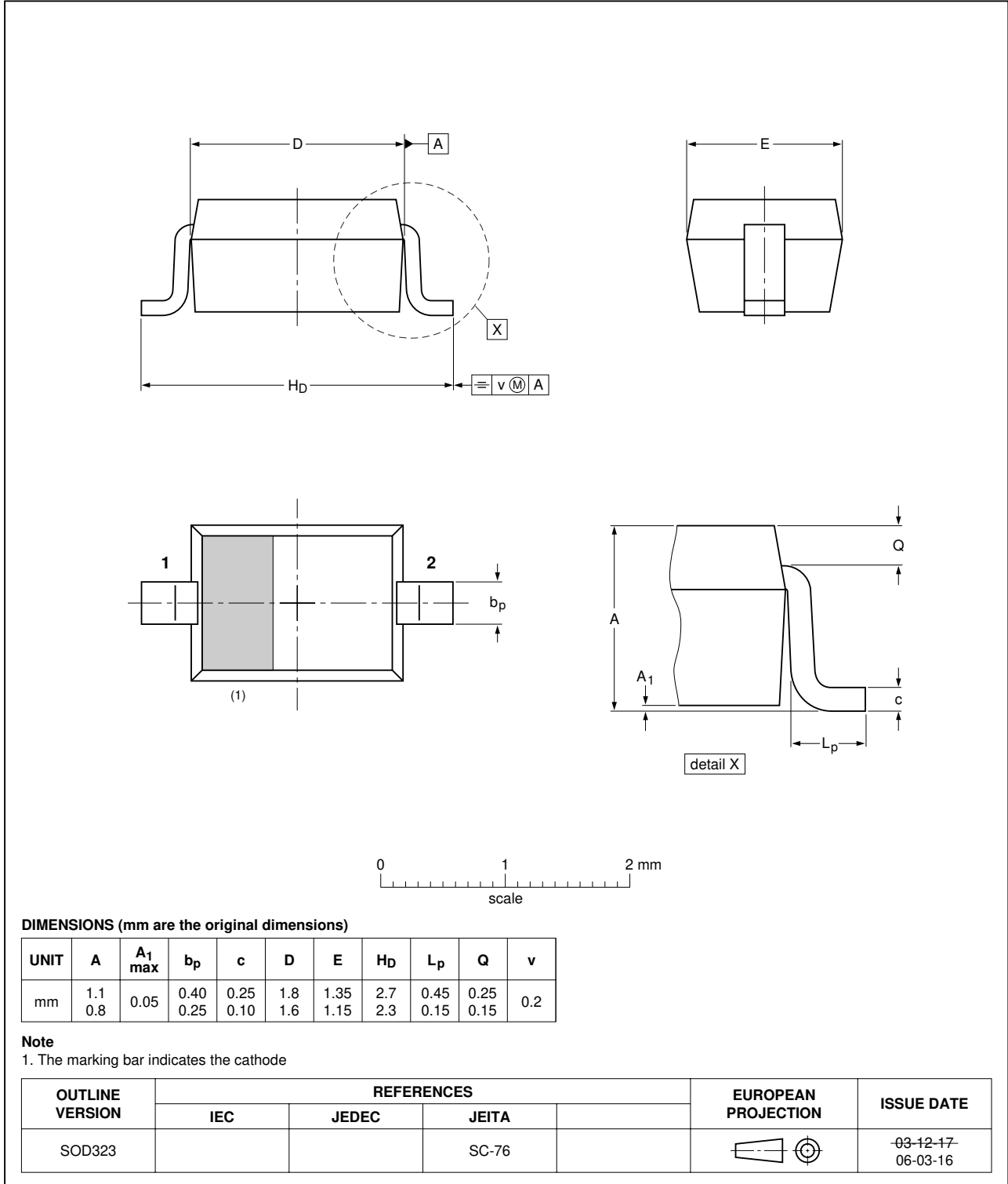

Fig 5. Package outline SOD323

8. Abbreviations

Table 6. Abbreviations

Acronym	Description
AQL	Acceptable Quality Level
PIN	P-type, Intrinsic, N-type
SMD	Surface Mounted Device
RF	Radio Frequency
S4	Special inspection level 4

9. Revision history

Table 7. Revision history

Document ID	Release date	Data sheet status	Change notice	Supersedes
BAP50-03_4	20090911	Product data sheet	-	BAP50-03_3
Modifications:	<ul style="list-style-type: none">The format of this data sheet has been redesigned to comply with the new identity guidelines of NXP Semiconductors.Legal texts have been adapted to the new company name where appropriate.			
BAP50-03_3	20040211	Product data sheet		BAP50-03_2
BAP50-03_2	19990510	Product data sheet		BAP50-03_N_1
BAP50-03_N_1	19990201	Preliminary data sheet		-

10. Legal information

10.1 Data sheet status

Document status ^{[1][2]}	Product status ^[3]	Definition
Objective [short] data sheet	Development	This document contains data from the objective specification for product development.
Preliminary [short] data sheet	Qualification	This document contains data from the preliminary specification.
Product [short] data sheet	Production	This document contains the product specification.

[1] Please consult the most recently issued document before initiating or completing a design.

[2] The term 'short data sheet' is explained in section "Definitions".

[3] The product status of device(s) described in this document may have changed since this document was published and may differ in case of multiple devices. The latest product status information is available on the Internet at URL <http://www.nxp.com>.

10.2 Definitions

Draft — The document is a draft version only. The content is still under internal review and subject to formal approval, which may result in modifications or additions. NXP Semiconductors does not give any representations or warranties as to the accuracy or completeness of information included herein and shall have no liability for the consequences of use of such information.

Short data sheet — A short data sheet is an extract from a full data sheet with the same product type number(s) and title. A short data sheet is intended for quick reference only and should not be relied upon to contain detailed and full information. For detailed and full information see the relevant full data sheet, which is available on request via the local NXP Semiconductors sales office. In case of any inconsistency or conflict with the short data sheet, the full data sheet shall prevail.

10.3 Disclaimers

General — Information in this document is believed to be accurate and reliable. However, NXP Semiconductors does not give any representations or warranties, expressed or implied, as to the accuracy or completeness of such information and shall have no liability for the consequences of use of such information.

Right to make changes — NXP Semiconductors reserves the right to make changes to information published in this document, including without limitation specifications and product descriptions, at any time and without notice. This document supersedes and replaces all information supplied prior to the publication hereof.

Suitability for use — NXP Semiconductors products are not designed, authorized or warranted to be suitable for use in medical, military, aircraft, space or life support equipment, nor in applications where failure or malfunction of an NXP Semiconductors product can reasonably be expected to result in personal injury, death or severe property or environmental

damage. NXP Semiconductors accepts no liability for inclusion and/or use of NXP Semiconductors products in such equipment or applications and therefore such inclusion and/or use is at the customer's own risk.

Applications — Applications that are described herein for any of these products are for illustrative purposes only. NXP Semiconductors makes no representation or warranty that such applications will be suitable for the specified use without further testing or modification.

Limiting values — Stress above one or more limiting values (as defined in the Absolute Maximum Ratings System of IEC 60134) may cause permanent damage to the device. Limiting values are stress ratings only and operation of the device at these or any other conditions above those given in the Characteristics sections of this document is not implied. Exposure to limiting values for extended periods may affect device reliability.

Terms and conditions of sale — NXP Semiconductors products are sold subject to the general terms and conditions of commercial sale, as published at <http://www.nxp.com/profile/terms>, including those pertaining to warranty, intellectual property rights infringement and limitation of liability, unless explicitly otherwise agreed to in writing by NXP Semiconductors. In case of any inconsistency or conflict between information in this document and such terms and conditions, the latter will prevail.

No offer to sell or license — Nothing in this document may be interpreted or construed as an offer to sell products that is open for acceptance or the grant, conveyance or implication of any license under any copyrights, patents or other industrial or intellectual property rights.

Export control — This document as well as the item(s) described herein may be subject to export control regulations. Export might require a prior authorization from national authorities.

10.4 Trademarks

Notice: All referenced brands, product names, service names and trademarks are the property of their respective owners.

11. Contact information

For more information, please visit: <http://www.nxp.com>

For sales office addresses, please send an email to: salesaddresses@nxp.com

12. Contents

1	Product profile	1
1.1	General description	1
1.2	Features	1
1.3	Applications	1
2	Pinning information	1
3	Ordering information	1
4	Limiting values	2
5	Thermal characteristics	2
6	Characteristics	2
7	Package outline	4
8	Abbreviations	5
9	Revision history	5
10	Legal information	6
10.1	Data sheet status	6
10.2	Definitions	6
10.3	Disclaimers	6
10.4	Trademarks	6
11	Contact information	6
12	Contents	7

Please be aware that important notices concerning this document and the product(s) described herein, have been included in section 'Legal information'.



© NXP B.V. 2009.

All rights reserved.

For more information, please visit: <http://www.nxp.com>

For sales office addresses, please send an email to: salesaddresses@nxp.com

Date of release: 11 September 2009

Document identifier: BAP50-03_4