



Chipsmall Limited consists of a professional team with an average of over 10 year of expertise in the distribution of electronic components. Based in Hongkong, we have already established firm and mutual-benefit business relationships with customers from,Europe,America and south Asia,supplying obsolete and hard-to-find components to meet their specific needs.

With the principle of “Quality Parts,Customers Priority,Honest Operation,and Considerate Service”,our business mainly focus on the distribution of electronic components. Line cards we deal with include Microchip,ALPS,ROHM,Xilinx,Pulse,ON,Everlight and Freescale. Main products comprise IC,Modules,Potentiometer,IC Socket,Relay,Connector.Our parts cover such applications as commercial,industrial, and automotives areas.

We are looking forward to setting up business relationship with you and hope to provide you with the best service and solution. Let us make a better world for our industry!



Contact us

Tel: +86-755-8981 8866 Fax: +86-755-8427 6832

Email & Skype: info@chipsmall.com Web: www.chipsmall.com

Address: A1208, Overseas Decoration Building, #122 Zhenhua RD., Futian, Shenzhen, China



SE400 Series

USER MANUAL



B+B SMARTWORX

Powered by

ADANTECH

Advantech B+B SmartWorx - Americas

707 Dayton Road
Ottawa, IL 61350 USA
Phone (815) 433-5100
Fax (815) 433-5105

Advantech B+B SmartWorx - European Headquarters

Westlink Commercial Park
Oranmore, Co. Galway, Ireland
Phone +353 91-792444
Fax +353 91-792445

www.advantech-bb.com
support@advantech-bb.com

CONTENTS

Product Overview..... 1

Supported Models..... 1
 Specifications..... 1
 Hardware Views..... 3
 Front View..... 3
 Rear View 8
 Top View..... 9
 Bottom View..... 10

Switch Installation..... 12

Installation Guidelines..... 12
 Connecting Hardware..... 12
 Verifying Switch Operation 12
 Installing the Switch 13
 DIN Rail Mounting..... 13
 Wall-Mounting..... 15
 Installing and Removing SFP Modules..... 17
 Installing SFP Modules..... 17
 Removing SFP Modules..... 19
 Connecting the Switch to Ethernet Ports 20
 RJ45 Ethernet Cable Wiring 20
 Power Supply Installation 20
 Overview..... 20
 Considerations..... 21
 Grounding the Device..... 22
 Wiring a Relay Contact..... 23
 Wiring the Power Inputs..... 23

Managing Switch..... 26

First Time set up..... 26
 Overview..... 26
 SCADA Requirements..... 26
 Administrative Interface Access..... 26
 Using the Graphical (Web) Interface 27
 Configuring the Switch for Network Access..... 27
 Configuring the Ethernet Ports 27
 Web Browser Configuration..... 29
 Preparing for Web Configuration 29
 Log In..... 29
 Recommended Practices..... 30
 Changing Default Password 30
 Monitoring 31
 Device Information..... 31
 Logging Message 32
 Port Monitoring 33
 Link Aggregation..... 34
 LLDP Statistics 34
 IGMP Statistics 35

System.....	36
IP Settings.....	36
DHCP Client Option 82.....	37
DHCP Auto Provision.....	38
IPv6 Settings.....	38
Management VLAN.....	39
System Time.....	40
L2 Switching.....	41
Port Configuration.....	41
Port Mirror.....	42
Link Aggregation.....	43
802.1Q VLAN.....	46
GARP.....	49
802.3az EEE.....	50
Multicast.....	51
SCADA Requirements.....	51
Jumbo Frame.....	56
Spanning Tree.....	57
X-Ring Elite.....	62
Loopback Detection.....	63
MAC Address Table.....	65
Static MAC.....	65
MAC Aging Time.....	66
Dynamic Forwarding Table.....	66
Security.....	67
Storm Control.....	67
Port Security.....	69
Protected Ports.....	69
DoS Prevention.....	70
Applications.....	72
802.1x.....	73
QoS.....	75
General.....	75
QoS Basic Mode.....	81
Rate Limit.....	82
Management.....	84
LLDP.....	84
SNMP.....	87
Diagnostics.....	91
Cable Diagnostics.....	91
Ping Test.....	92
IPv6 Ping Test.....	93
System Log.....	94
DDM.....	97
Tools.....	98
IXM.....	98
Backup Manager.....	99
Upgrade Manager.....	100
Dual Image.....	101
Save Configuration.....	101
User Account.....	102
Reset System.....	102
Reboot Device.....	102

Troubleshooting 103

Advantech B+B Smartworx Technical support 103

LIST OF FIGURES

Figure 1:	Front View	3
Figure 2:	Front View	4
Figure 3:	Front View	5
Figure 4:	Front View	6
Figure 5:	System LED Panel	7
Figure 6:	Rear View	8
Figure 7:	Rear View	9
Figure 8:	Top View.....	9
Figure 9:	Top View.....	10
Figure 10:	Bottom View	10
Figure 11:	Bottom View	11
Figure 12:	Installing the DIN-Rail Mounting Kit.....	13
Figure 13:	Removing the DIN-Rail.....	14
Figure 14:	Installing Wall Mount Plates	15
Figure 15:	Securing Wall Mounting Screws.....	16
Figure 16:	Wall Mount Installation	16
Figure 17:	Removing the Dust Plug from an SFP Slot	17
Figure 18:	Installing an SFP Transceiver.....	18
Figure 19:	Attaching a Fiber Optic Cable to a Transceiver.....	18
Figure 20:	Removing a Fiber Optic Cable to a Transceiver.....	19
Figure 21:	Removing an SFP Transceiver.....	19
Figure 22:	Ethernet Plug & Connector Pin Position	20
Figure 23:	Power Wiring for SE400 Series	21
Figure 24:	Grounding Connection.....	22
Figure 25:	Terminal Receptor: Relay Contact	23
Figure 26:	Terminal Receptor: Power Input Contacts.....	23
Figure 27:	Removing a Terminal Block.....	24
Figure 28:	Installing DC Wires in a Terminal Block	24
Figure 29:	Installing DC Wires in a Terminal Block	24
Figure 30:	Securing a Terminal Block to a Receptor	25
Figure 31:	Login Screen	29
Figure 32:	Changing a Default Password	30
Figure 33:	Monitoring > Device Information.....	31
Figure 34:	Monitoring > Logging Message	32
Figure 35:	Monitoring > Port Monitoring > Port Statistics	33
Figure 36:	Monitoring > Port Monitoring > Port Utilization	33
Figure 37:	Monitoring > LLDP Statistics	34
Figure 38:	Monitoring > IGMP Statistics	35
Figure 39:	System > IP Settings	36
Figure 40:	System > DHCP Client Option 82.....	37
Figure 41:	System > DHCP Auto Provision	38
Figure 42:	System > IPv6 Settings	38
Figure 43:	System > Management VLAN	39
Figure 44:	System > System Time.....	40
Figure 45:	L2 Switching > Port Configuration	41
Figure 46:	L2 Switching > Port Mirror	42
Figure 47:	L2 Switching > Link Aggregation > Load Balance	43
Figure 48:	L2 Switching > Link Aggregation > LAG Management.....	43
Figure 49:	L2 Switching > Link Aggregation > LAG Port Settings	44
Figure 50:	L2 Switching > Link Aggregation > LACP Priority Settings	45
Figure 51:	L2 Switching > Link Aggregation > LACP Port Settings.....	45
Figure 52:	L2 Switching > 802.1Q VLAN > VLAN Management	46
Figure 53:	L2 Switching > 802.1Q VLAN > PVID Settings	47
Figure 54:	L2 Switching > 802.1Q VLAN > Port to VLAN.....	48
Figure 55:	L2 Switching > GARP > GARP Settings.....	49

Figure 56:	L2 Switching > GARP > GVRP Settings.....	50
Figure 57:	L2 Switching > 802.3az EEE.....	50
Figure 58:	L2 Switching > Multicast > Multicast Filtering.....	51
Figure 59:	L2 Switching > Multicast > IGMP Snooping > IGMP Settings.....	52
Figure 60:	L2 Switching > Multicast > IGMP Snooping > IGMP Querier.....	52
Figure 61:	L2 Switching > Multicast > IGMP Snooping > IGMP Static Groups.....	53
Figure 62:	L2 Switching > Multicast > MLD Snooping > MLD Settings.....	54
Figure 63:	L2 Switching > Multicast > MLD Snooping > MLD Querier.....	55
Figure 64:	L2 Switching > Multicast > MLD Snooping > MLD Static Group.....	55
Figure 65:	L2 Switching > Jumbo Frame.....	56
Figure 66:	L2 Switching > Spanning Tree > STP Global Settings.....	57
Figure 67:	L2 Switching > Spanning Tree > STP Port Settings.....	58
Figure 68:	L2 Switching > Spanning Tree > STP Bridge Settings.....	59
Figure 69:	L2 Switching > Spanning Tree > STP Port Advanced Settings.....	60
Figure 70:	L2 Switching > Spanning Tree > MST Config Identification.....	60
Figure 71:	L2 Switching > Spanning Tree > MST Instance ID Settings.....	61
Figure 72:	L2 Switching > Spanning Tree > MST Instance Priority Settings.....	61
Figure 73:	L2 Switching > X-Ring Elite > X-Ring Elite Settings.....	62
Figure 74:	L2 Switching > X-Ring Elite > X-Ring Elite Groups.....	63
Figure 75:	L2 Switching > Loopback Detection > Global Settings.....	63
Figure 76:	L2 Switching > Loopback Detection > Port Settings.....	64
Figure 77:	MAC Address Table > Static MAC.....	65
Figure 78:	MAC Address Table > MAC Aging Time.....	66
Figure 79:	MAC Address Table > Dynamic Forwarding Table.....	66
Figure 80:	Security > Storm Control > Global Settings.....	67
Figure 81:	Security > Storm Control > Port Settings.....	68
Figure 82:	Security > Port Security.....	69
Figure 83:	Security > Protected Ports.....	69
Figure 84:	Security > DoS Prevention > DoS Global Settings.....	70
Figure 85:	Security > DoS Prevention > DoS Port Settings.....	72
Figure 86:	Security > Applications > HTTP.....	72
Figure 87:	Security > 802.1x > 802.1x Settings.....	73
Figure 88:	Security > 802.1x > 802.1x Port Configuration.....	74
Figure 89:	QoS > General > QoS Properties.....	75
Figure 90:	QoS > General > QoS Settings.....	76
Figure 91:	QoS > General > QoS Scheduling.....	77
Figure 92:	QoS > General > CoS Mapping.....	78
Figure 93:	QoS > General > DSCP Mapping.....	79
Figure 94:	QoS > General > IP Precedence Mapping.....	80
Figure 95:	QoS > QoS Basic Mode > Global Settings.....	81
Figure 96:	QoS > QoS Basic Mode > Port Settings.....	81
Figure 97:	QoS > Rate Limit > Ingress Bandwidth Control.....	82
Figure 98:	QoS > Rate Limit > Egress Bandwidth Control.....	83
Figure 99:	QoS > Rate Limit > Egress Queue.....	83
Figure 100:	Management > LLDP > LLDP System Settings.....	84
Figure 101:	Management > LLDP > LLDP Port Settings > LLDP Port Configuration.....	85
Figure 102:	Management > LLDP > LLDP Port Settings > Optional TLVs Selection.....	85
Figure 103:	Management > LLDP > LLDP Port Settings > VLAN Name TLV VLAN Selection.....	86
Figure 104:	Management > LLDP > LLDP Remote Device Info.....	86
Figure 105:	Management > SNMP > SNMP Settings.....	87
Figure 106:	Management > SNMP > SNMP Community.....	88
Figure 107:	Management > SNMP > SNMP User Settings.....	89
Figure 108:	Management > SNMP > SNMP Trap.....	90
Figure 109:	Diagnostics > Cable Diagnostics.....	91
Figure 110:	Diagnostics > Ping Test.....	92
Figure 111:	Diagnostics > IPv6 Ping Test.....	93
Figure 112:	Diagnostics > System Log > Logging Service.....	94
Figure 113:	Diagnostics > System Log > Local Logging.....	95

Figure 114: Diagnostics > System Log > System Log Server	96
Figure 115: Diagnostics > DDM.....	97
Figure 116: Diagnostics > DDM > Diagnostic Alarm Information	97
Figure 117: Tools > IXM	98
Figure 118: Tools > Backup Manager.....	99
Figure 119: Tools > Upgrade Manager.....	100
Figure 120: Tools > Dual Image	101
Figure 121: Tools > User Account	102

LIST OF TABLES

Table 1:	Standard Models	1
Table 2:	Wide Temperature Models	1
Table 3:	Specifications	1
Table 4:	Front View	3
Table 5:	Front View	4
Table 6:	Front View	5
Table 7:	Front View	6
Table 8:	System LED Panel	7
Table 9:	Rear View	8
Table 10:	Rear View	9
Table 11:	Top View.....	9
Table 12:	Top View.....	10
Table 13:	Bottom View	10
Table 14:	Bottom View	11
Table 15:	Pin Definition	20
Table 16:	Monitoring > Device Information.....	31
Table 17:	Monitoring > Logging Message	32
Table 18:	Monitoring > Port Monitoring > Port Statistics	33
Table 19:	Monitoring > Port Monitoring > Port Utilization	33
Table 20:	Monitoring > LLDP Statistics	34
Table 21:	Monitoring > IGMP Statistics	35
Table 22:	System > IP Settings	36
Table 23:	System > DHCP Client Option 82.....	37
Table 24:	System > DHCP Auto Provision	38
Table 25:	System > IPv6 Settings	38
Table 26:	System > Management VLAN	39
Table 27:	System > System Time.....	40
Table 28:	L2 Switching > Port Configuration	41
Table 29:	L2 Switching > Port Mirror	42
Table 30:	L2 Switching > Link Aggregation > Load Balance	43
Table 31:	L2 Switching > Link Aggregation > LAG Management.....	43
Table 32:	L2 Switching > Link Aggregation > LAG Port Settings	44
Table 33:	L2 Switching > Link Aggregation > LACP Priority Settings	45
Table 34:	L2 Switching > Link Aggregation > LACP Port Settings.....	45
Table 35:	L2 Switching > 802.1Q VLAN > VLAN Management	46
Table 36:	L2 Switching > 802.1Q VLAN > PVID Settings	47
Table 37:	L2 Switching > 802.1Q VLAN > Port to VLAN.....	48
Table 38:	L2 Switching > GARP > GARP Settings.....	49
Table 39:	L2 Switching > GARP > GVRP Settings.....	50
Table 40:	L2 Switching > 802.3az EEE	50
Table 41:	L2 Switching > Multicast > Multicast Filtering.....	51
Table 42:	L2 Switching > Multicast > IGMP Snooping > IGMP Settings	52
Table 43:	L2 Switching > Multicast > IGMP Snooping > IGMP Querier	53
Table 44:	L2 Switching > Multicast > IGMP Snooping > IGMP Static Groups	53
Table 45:	L2 Switching > Multicast > MLD Snooping > MLD Settings	54
Table 46:	L2 Switching > Multicast > MLD Snooping > MLD Querier	55
Table 47:	L2 Switching > Multicast > MLD Snooping > MLD Static Group	55
Table 48:	L2 Switching > Jumbo Frame	56
Table 49:	L2 Switching > Spanning Tree > STP Global Settings	57
Table 50:	L2 Switching > Spanning Tree > STP Port Settings	58
Table 51:	L2 Switching > Spanning Tree > STP Bridge Settings	59
Table 52:	L2 Switching > Spanning Tree > STP Port Advanced Settings.....	60
Table 53:	L2 Switching > Spanning Tree > MST Config Identification	60
Table 54:	L2 Switching > Spanning Tree > MST Instance ID Settings.....	61
Table 55:	L2 Switching > Spanning Tree > MST Instance Priority Settings	61

Table 56:	L2 Switching > X-Ring Elite > X-Ring Elite Settings	62
Table 57:	L2 Switching > Loopback Detection > Global Settings	63
Table 58:	L2 Switching > Loopback Detection > Port Settings	64
Table 59:	MAC Address Table > Static MAC	65
Table 60:	MAC Address Table > MAC Aging Time	66
Table 61:	MAC Address Table > Dynamic Forwarding Table	66
Table 62:	Security > Storm Control > Global Settings	67
Table 63:	Security > Storm Control > Port Settings	68
Table 64:	Security > Port Security	69
Table 65:	Security > Protected Ports	69
Table 66:	Security > DoS Prevention > DoS Global Settings	71
Table 67:	Security > DoS Prevention > DoS Port Settings	72
Table 68:	Security > Applications > HTTP	72
Table 69:	Security > 802.1x > 802.1x Settings	73
Table 70:	Security > 802.1x > 802.1x Port Configuration	74
Table 71:	QoS > General > QoS Properties	75
Table 72:	QoS > General > QoS Settings	76
Table 73:	QoS > General > QoS Scheduling	77
Table 74:	QoS > General > CoS Mapping	78
Table 75:	QoS > General > DSCP Mapping	79
Table 76:	QoS > General > IP Precedence Mapping	80
Table 77:	QoS > QoS Basic Mode > Global Settings	81
Table 78:	QoS > QoS Basic Mode > Port Settings	81
Table 79:	QoS > Rate Limit > Ingress Bandwidth Control	82
Table 80:	QoS > Rate Limit > Egress Bandwidth Control	83
Table 81:	QoS > Rate Limit > Egress Queue	83
Table 82:	Management > LLDP > LLDP System Settings	84
Table 83:	Management > LLDP > LLDP Port Settings > LLDP Port Configuration	85
Table 84:	Management > LLDP > LLDP Port Settings > Optional TLVs Selection	85
Table 85:	Management > LLDP > LLDP Port Settings > VLAN Name TLV VLAN Selection	86
Table 86:	Management > LLDP > LLDP Remote Device Info	86
Table 87:	Management > SNMP > SNMP Settings	87
Table 88:	Management > SNMP > SNMP Community	88
Table 89:	Management > SNMP > SNMP User Settings	89
Table 90:	Management > SNMP > SNMP Trap	90
Table 91:	Diagnostics > Cable Diagnostics	91
Table 92:	Diagnostics > Ping Test	92
Table 93:	Diagnostics > IPv6 Ping Test	93
Table 94:	Diagnostics > System Log > Logging Service	94
Table 95:	Diagnostics > System Log > Local Logging	95
Table 96:	Diagnostics > System Log > System Log Server	96
Table 97:	Diagnostics > DDM	97
Table 98:	Diagnostics > DDM > Diagnostic Alarm Information	97
Table 99:	Tools > IXM	98
Table 100:	Tools > Backup Manager	99
Table 101:	Tools > Upgrade Manager	100
Table 102:	Tools > Dual Image	101
Table 103:	Tools > User Account	102

DECLARATION OF CONFORMITY

CE

This product has passed the CE test for environmental specifications when shielded cables are used for external wiring. We recommend the use of shielded cables. This kind of cable is available from Advantech. Please contact your local supplier for ordering information.

This product has passed the CE test for environmental specifications. Test conditions for passing included the equipment being operated within an industrial enclosure. In order to protect the product from being damaged by ESD (Electrostatic Discharge) and EMI leakage, we strongly recommend the use of CE-compliant industrial enclosure products.

FCC Class A

This equipment has been tested and found to comply with the limits for a Class A digital device, pursuant to part 15 of the FCC Rules. These limits are designed to provide reasonable protection against harmful interference when the equipment is operated in a commercial environment. This equipment generates, uses, and can radiate radio frequency energy and, if not installed and used in accordance with the instruction manual, may cause harmful interference to radio communications. Operation of this equipment in a residential area is likely to cause harmful interference in which case the user will be required to correct the interference at his own expense.

Safety Instructions

- Read these safety instructions carefully.
- Keep this user manual for later reference.
- Disconnect this equipment from any AC outlet before cleaning. Use damp cloth. Do not use liquid or spray detergents for cleaning.
- For plug-in equipment, the power outlet socket must be located near the equipment and must be easily accessible.
- Keep this equipment away from humidity.
- Put this equipment on a reliable surface during installation. Dropping it or letting it fall may cause damage.
- The openings on the enclosure are for air convection. Protect the equipment from overheating. **DO NOT COVER THE OPENINGS.**
- Make sure the voltage of the power source is correct before connecting the equipment to the power outlet.
- Position the power cord so that people cannot step on it. Do not place anything over the power cord.
- All cautions and warning on the equipment should be noted.
- If the equipment is not used for a long time, disconnect it from the power source to avoid damage by transient over voltage.
- Never pour any liquid into an opening. This may cause fire or electrical shock.
- Never open the equipment. For safety reasons, the equipment should be opened only by qualified service personnel.
- If one of the following situations arises, get the equipment checked by service personnel:
 - The power cord or plug is damaged.
 - Liquid has penetrated into the equipment.

- The equipment has been exposed to moisture.
- The equipment does not work well, or you cannot get it to work according to the user manual
- The equipment has been dropped and damaged.
- The equipment has obvious signs of breakage.
- Instructions for installation in a pollution Degree 2 environment or equivalent statement.
- PoE requirements:
This product was in-door used and not connected to outside plant, so user manual shall have the description as below or equivalent: “The equipment is to be connected only to PoE networks without routing to the outside plant.”
- Do NOT LEAVE THIS EQUIPMENT IN AN ENVIRONMENT WHERE THE STORAGE TEMPERATURE MAY GO BELOW -40°C(-40°F) OR ABOVE 75°C(167°F) THIS COULD DAMAGE THE EQUIPMENT. THE EQUIPMENT SHOULD BE IN A CONTROLLED ENVIRONMENT.

PRODUCT WARRANTY – LIMITED LIFETIME

Effective for products of Advantech B+B SmartWorx shipped on or after May 1, 2013, Advantech B+B SmartWorx warrants that each such product shall be free from defects in material and workmanship for its lifetime. This limited lifetime warranty is applicable solely to the original user and is not transferable. Power supplies are exempt from the limited lifetime warranty and are covered by a six year warranty.

This warranty is expressly conditioned upon proper storage, installation, connection, operation and maintenance of products in accordance with their written specifications.

Pursuant to the warranty, within the warranty period, Advantech B+B SmartWorx, at its option will:

1. Replace the product with a functional equivalent;
2. Repair the product; or
3. Provide a partial refund of purchase price based on a depreciated value.

Products of other manufacturers sold by Advantech B+B SmartWorx are not subject to any warranty or indemnity offered by Advantech B+B SmartWorx, but may be subject to the warranties of the other manufacturers.

Notwithstanding the foregoing, under no circumstances shall Advantech B+B SmartWorx have any warranty obligations or any other liability for: (i) any defects resulting from wear and tear, accident, improper use by the buyer or use by any third party except in accordance with the written instructions or advice of the Advantech B+B SmartWorx or the manufacturer of the products, including without limitation surge and overvoltage conditions that exceed specified ratings, (ii) any products which have been adjusted, modified or repaired by any party other than Advantech B+B SmartWorx or (iii) any descriptions, illustrations, figures as to performance, drawings and particulars of weights and dimensions contained in the Advantech B+B SmartWorx' catalogs, price lists, marketing materials or elsewhere since they are merely intended to represent a general idea of the products and do not form part of this price quote and do not constitute a warranty of any kind, whether express or implied, as to any of the Advantech B+B SmartWorx's products.

THE REPAIR OR REPLACEMENT OF THE DEFECTIVE ITEMS IN ACCORDANCE WITH THE EXPRESS WARRANTY SET FORTH ABOVE IS ADVANTECH B+B SMARTWORX SOLE OBLIGATION UNDER THIS WARRANTY. THE WARRANTY CONTAINED IN THIS SECTION SHALL EXTEND TO THE ORIGINAL USER ONLY, IS IN LIEU OF ANY AND ALL OTHER WARRANTIES, EXPRESS OR IMPLIED, AND ALL SUCH WARRANTIES AND INDEMNITIES ARE EXPRESSLY DISCLAIMED, INCLUDING WITHOUT LIMITATION (I) THE IMPLIED WARRANTIES OF FITNESS FOR A PARTICULAR PURPOSE AND OF MER-

CHANTABILITY AND (II) ANY WARRANTY THAT THE PRODUCTS ARE DO NOT INFRINGE OR VIOLATE THE INTELLECTUAL PROPERTY RIGHTS OF ANY THIRD PARTY. IN NO EVENT SHALL ADVANTECH B+B SMARTWORX BE LIABLE FOR LOSS OF BUSINESS, LOSS OF USE OR OF DATA INTERRUPTION OF BUSINESS, LOST PROFITS OR GOODWILL OR OTHER SPECIAL, INCIDENTAL, EXEMPLARY OR CONSEQUENTIAL DAMAGES. ADVANTECH B+B SMARTWORX SHALL DISREGARD AND NOT BE BOUND BY ANY REPRESENTATIONS, WARRANTIES OR INDEMNITIES MADE BY ANY OTHER PERSON, INCLUDING WITHOUT LIMITATION EMPLOYEES, DISTRIBUTORS, RESELLERS OR DEALERS OF ADVANTECH B+B SMARTWORX WHICH ARE INCONSISTENT WITH THE WARRANTY, SET FORTH ABOVE.

RETURNS POLICY

Eligible items returned within 30 days of purchase qualify for a full refund (less shipping charges). Advantech B+B SmartWorx has the option to accept returns of products 30 days after the date of purchase and such returns are subject to a restocking fee of up to 20%. Software is not returnable if opened. Advantech B+B SmartWorx will not accept returns of products that were modified by a customer. All custom orders are non-returnable and non-cancelable.

REPAIR SERVICE: We offer a repair service for our products. Please call, FAX, or e-mail to request a Return Material Authorization (RMA) number and routing instructions. Shipping charges and any duties, taxes or brokerage fees are the customer's responsibility.

RETURN AND REPAIR CONTACT INFORMATION

Phone: (815) 433-5100 7:00 AM - 7:00 PM CST

Fax: (815) 433-5109

Email: orders@advantech-bb.com

WARNINGS, CAUTIONS AND NOTES

Warning! *Warnings indicate conditions, which if not observed, can cause personal injury!*



Caution! *Cautions are included to help you avoid damaging hardware or losing data. e.g.*



There is a danger of a new battery exploding if it is incorrectly installed. Do not attempt to recharge, force open, or heat the battery. Replace the battery only with the same or equivalent type recommended by the manufacturer. Discard used batteries according to the manufacturer's instructions.

Note! *Notes provide optional additional information.*



PRODUCT OVERVIEW

Supported Models

Standard Models:

Table 1: Standard Models

SE408	SEC410-2SFP	SE416
SEC418-2SFP		

Wide Temperature Models:

Table 2: Wide Temperature Models

SE408-EI-T	SE408-PN-T	SE408-PNMA-T
SE408-T	SEC410-2SFP-EI-T	SEC410-2SFP-PN-T
SEC410-2SFP-T	SE416-EI-T	SE416-PN-T
SE416-T	SEC418-2SFP-EI-T	SEC418-2SFP-PN-T
SEC418-2SFP-T		

Specifications

Table 3: Specifications

Specifications	Description	
Interface	I/O Port	<ul style="list-style-type: none"> ■ SE408 series: 8 x 10/100BaseT(X) ■ SE416 series: 16 x 10/100BaseT(X) ■ SEC410 series: 8 x 10/100BaseT(X) + 2 x 10/100Base-T(X) or 100Base-FX SFP ■ SEC418 series: 16 x 10/100BaseT(X) + 2 x 10/100Base-T(X) or 100Base-FX SFP
	Power Connector	6-pin screw Terminal Block (including relay)
Physical	Enclosure	Metal Shell
	Protection Class	IP30
	Installation	DIN-Rail and Wall-Mount
	Dimensions (W x H x D)	<ul style="list-style-type: none"> ■ SE408 series: 43mm x 120mm x 84mm (1.69in x 4.72in x 3.3in) ■ SE416 series: 74mm x 120mm x 84mm (2.91in x 4.72in x 3.3in) ■ SEC410 series: 74mm x 120mm x 84mm (2.91in x 4.72in x 3.3in) ■ SEC418 series: 74mm x 120mm x 84mm (2.91in x 4.72in x 3.3in)
LED Display	System LED	PWR1, PWR2, P-Fail, Loop detection PoE
	Port LED	Link / Speed / Activity

Table 3: Specifications (Continued)

Specifications	Description	
Environment	Operating Temperature	Standard Temperature: -10°C ~ 60°C (14°F ~ 140°F) Wide Temperature: -40°C ~ 75°C (-40°F ~ 167°F)
	Storage Temperature	-40°C ~ 85° C (-40°F ~ 185° F)
	Ambient Relative Humidity	10 ~ 95% (non-condensing)
Switch Properties	MAC Address	8K entries
	Switching Bandwidth	<ul style="list-style-type: none"> ■ SE408 series : 1.6Gbps ■ SE416 series : 3.2Gbps ■ SEC410 series: 5.6Gbps ■ SEC418 series: 7.2Gbps
Power	Power Consumption	<ul style="list-style-type: none"> ■ SE408 series: 5.2 watts ■ SE416 series: 8 watts ■ SEC410 series: 5.8 watts ■ SEC418 series: 8.2 watts
	Power Input	12V ~ 48V (8.4V ~ 52.8V), redundant dual inputs
Certifications	Safety	<ul style="list-style-type: none"> ■ IEC/EN 60950-1, UL508 ■ Class 1 Division 2, IECEx, ATEX
	EMC	CE, FCC
	EMI	EN 55011/ 55022 Class A, EN 61000-6-4, FCC Part 15 Subpart B Class A
	EMS	<ul style="list-style-type: none"> ■ EN 55024/ EN 61000-6-2 ■ EN 61000-4-2 (ESD) Level 3 ■ EN 61000-4-3 (RS) Level 3 ■ EN 61000-4-4 (EFT) Level 3 ■ EN 61000-4-5 (Surge) Level 3 ■ EN 61000-4-6 (CS) Level 3 ■ EN 61000-4-8 (Magnetic Field) Level 3
	Shock	IEC 60068-2-27
	Freefall	IEC 60068-2-32
	Vibration	IEC 60068-2-6

Hardware Views

Front View

The following view applies to SE408 series.

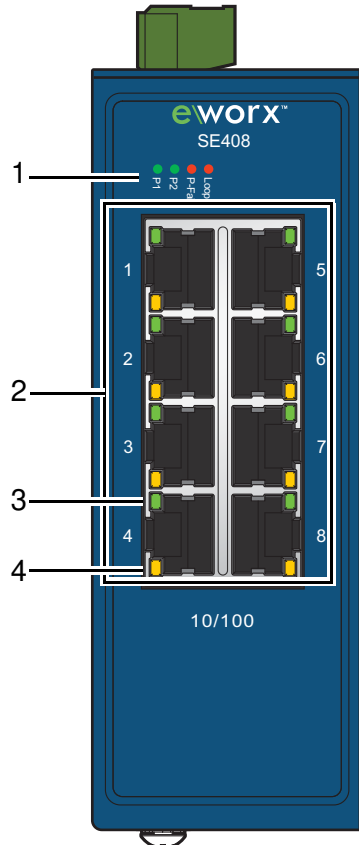

Figure 1: Front View

Table 4: Front View

No.	Item	Description
1	System LED panel	See "System LED Panel" on page 7 for further details.
2	ETH port	Eight 10/100BaseT(X) ports.
3	LNK/ACT LED	Link activity LED.
4	Speed LED	<ul style="list-style-type: none"> ■ Gigabit Ethernet: <ul style="list-style-type: none"> - Green: 1000M - Amber: 100M - Off: 10M ■ Fast Ethernet: <ul style="list-style-type: none"> - Amber: 100M - Off: 10M

The following view applies to SE416 series.

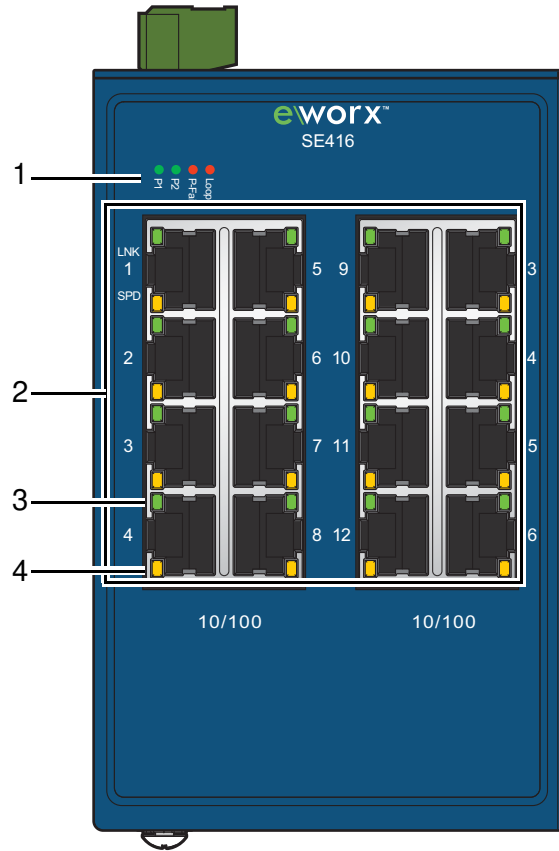

Figure 2: Front View

Table 5: Front View

No.	Item	Description
1	System LED panel	See "System LED Panel" on page 7 for further details.
2	ETH port	Sixteen 10/100BaseT(X) ports.
3	LNK/ACT LED	Link activity LED.
4	Speed LED	<ul style="list-style-type: none"> ■ Fast Ethernet: – Amber: 100M – Off: 10M

The following view applies to SEC410 series.

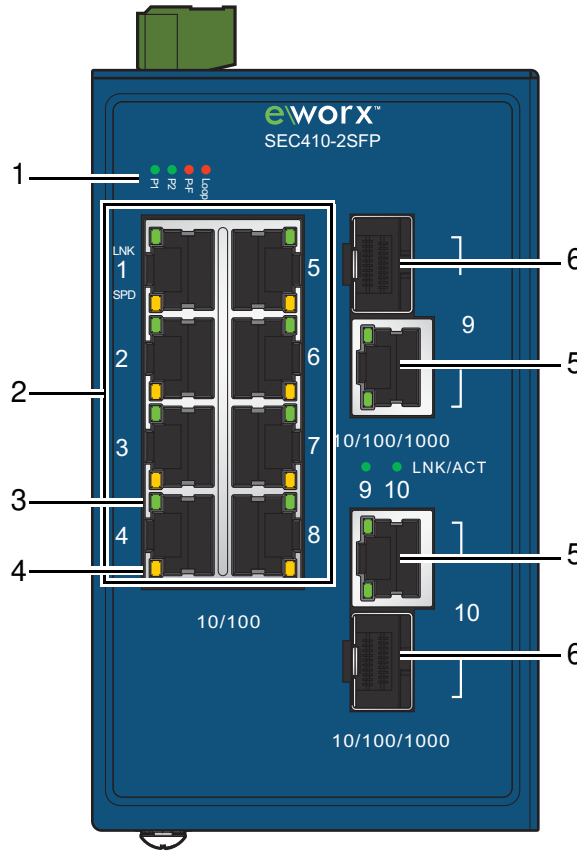

Figure 3: Front View

Table 6: Front View

No.	Item	Description
1	System LED panel	See “System LED Panel” on page 7 for further details.
2	ETH port	Eight 10/100BaseT(X) ports + two 100/1000BaseT(X) combo ports.
3	LNK/ACT LED	Link activity LED.
4	Speed LED	<ul style="list-style-type: none"> ■ Gigabit Ethernet: <ul style="list-style-type: none"> – Green: 1000M – Amber: 100M – Off: 10M
5	ETH port	Two 10/100/1000BaseT(X) ports.
6	ETH port	Two 100/1000Base-FX SFP ports.

The following view applies to SEC418 series.

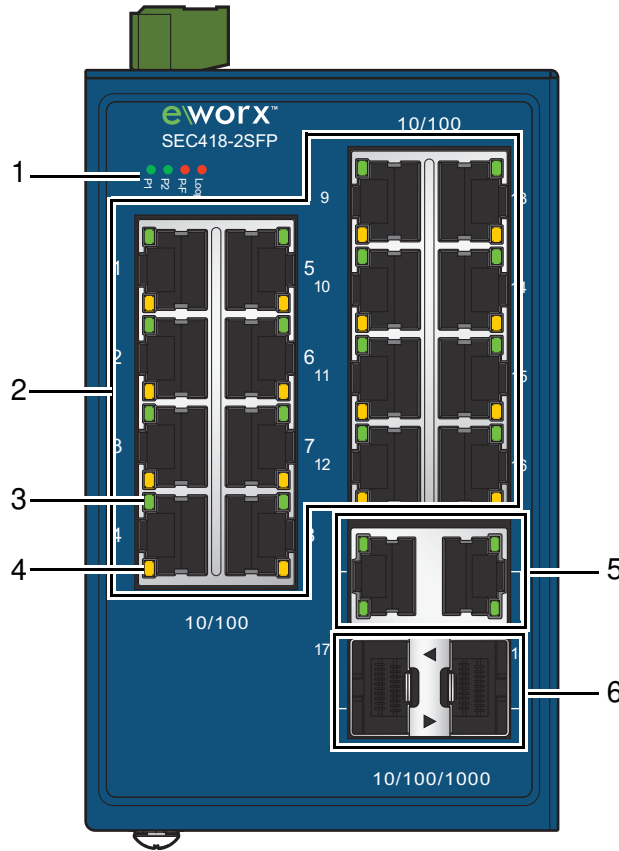

Figure 4: Front View

Table 7: Front View

No.	Item	Description
1	System LED panel	See “System LED Panel” on page 7 for further details.
2	ETH port	Sixteen 10/100BaseT(X) ports + two 100/1000BaseT(X) combo ports.
3	LNK/ACT LED	Link activity LED.
4	Speed LED	<ul style="list-style-type: none"> ■ Gigabit Ethernet: <ul style="list-style-type: none"> – Green: 1000M – Amber: 100M – Off: 10M
5	ETH port	Two 10/100/1000BaseT(X) ports.
6	ETH port	Two 100/1000Base-FX SFP ports.

System LED Panel

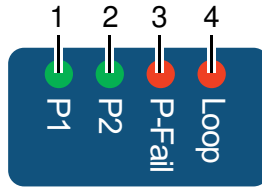

Figure 5: System LED Panel

Table 8: System LED Panel

No.	LED Name	LED Color	Description
1	PW1 LED	Solid green	Powered up.
		Off	Powered down or not installed.
2	PW2 LED	Solid green	Powered up.
		Off	Powered down or not installed.
3	P-Fail	Solid red	When PW1 or PW2 is disconnected, the LED lights.
		Off	When PW1 and PW2 is connected, the LED is off.
4	Loop	Solid red	When loop detected, the LED lights.
		Off	No loop detected.

Rear View

The following view applies to SE408 series.

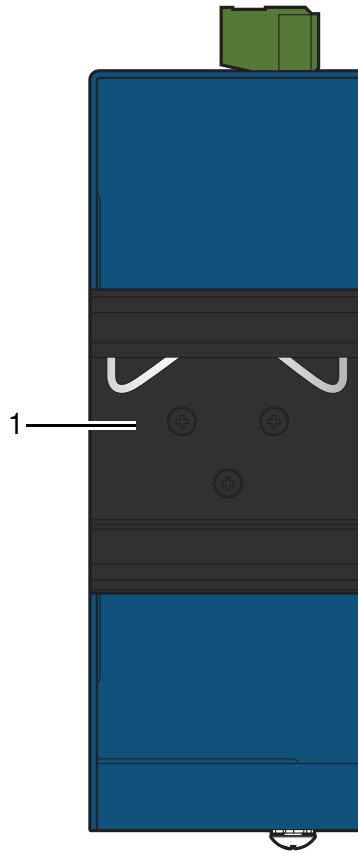

Figure 6: Rear View

Table 9: Rear View

No.	Item	Description
1	DIN-Rail mounting plate	Mounting plate used for the installation to a standard DIN rail.

The following view applies to SE416, SEC410, SEC418 series.

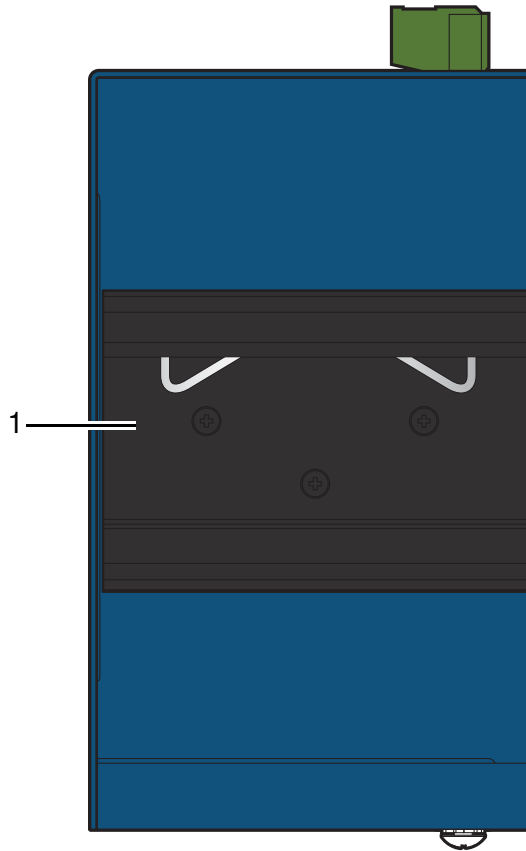

Figure 7: Rear View

Table 10: Rear View

No.	Item	Description
1	DIN-Rail mounting plate	Mounting plate used for the installation to a standard DIN rail.

Top View

The following view applies to SE408 series.

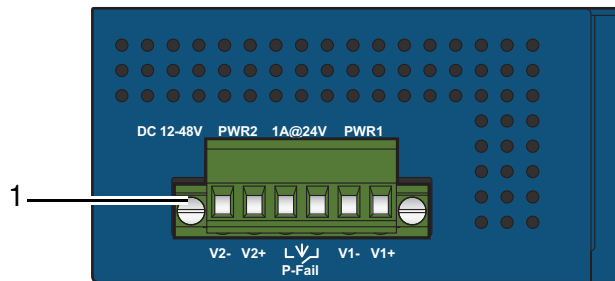

Figure 8: Top View

Table 11: Top View

No.	Item	Description
1	Terminal block	Connect cabling for power and alarm wiring.

The following view applies to SE416, SEC410, SEC418 series.

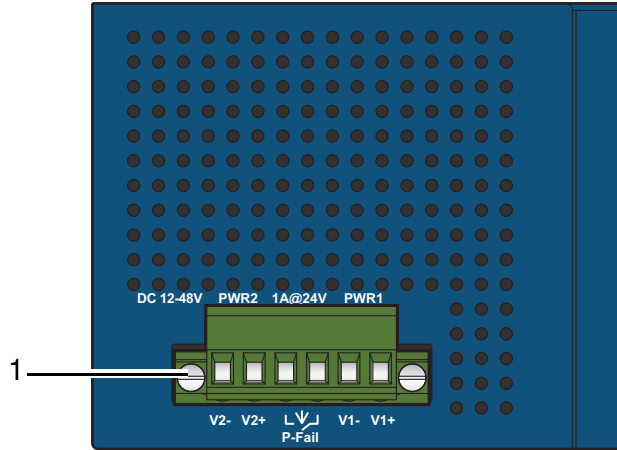

Figure 9: Top View

Table 12: Top View

No.	Item	Description
1	Terminal block	Connect cabling for power and alarm wiring.

Bottom View

The following view applies to SE408 series.

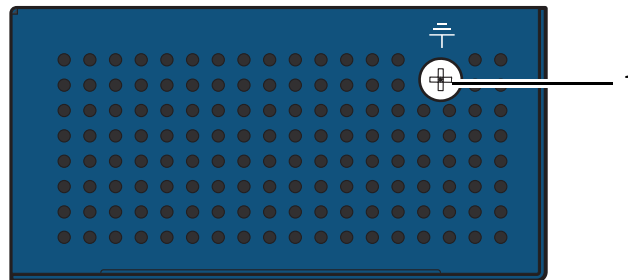

Figure 10: Bottom View

Table 13: Bottom View

No.	Item	Description
1	Ground terminal	Screw terminal used to ground chassis.

The following view applies to SE416, SEC410, SEC418 series.

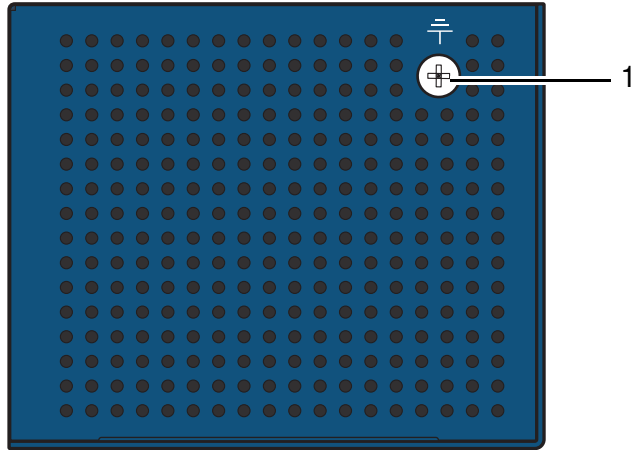

Figure 11: Bottom View

Table 14: Bottom View

No.	Item	Description
1	Ground terminal	Screw terminal used to ground chassis.

SWITCH INSTALLATION

Installation Guidelines

The following guidelines are provided to optimize the device performance. Review the guidelines before installing the device.

- Make sure cabling is away from sources of electrical noise. Radios, power lines, and fluorescent lighting fixtures can interfere with the device performance.
- Make sure the cabling is positioned away from equipment that can damage the cables.
- Operating environment is within the ranges listed range, see “Specifications” on page 1.
- Relative humidity around the switch does not exceed 95 percent (noncondensing).
- Altitude at the installation site is not higher than 10,000 feet.
- In 10/100 fixed port devices, the cable length from the switch to connected devices can not exceed 100 meters (328 feet).
- Make sure airflow around the switch and respective vents is unrestricted. Without proper airflow the switch can overheat. To prevent performance degradation and damage to the switch, make sure there is clearance at the top and bottom and around the exhaust vents.

Connecting Hardware

These instructions will explain how to find a proper location for your Modbus Gateways, how to connect to the network, hook up the power cable, and connect to the SE400 Series.

Verifying Switch Operation

Before installing the device in a rack or on a wall, power on the switch to verify that the switch passes the power-on self-test (POST). To connect the cabling to the power source see “Power Supply Installation” on page 20.

At startup (POST), the System LED blinks green, while the remaining LEDs are a solid green. Once the switch passes POST self-test, the System LED turns green. The other LEDs turn off and return to their operating status. If the switch fails POST, the System LED switches to an amber state.

After a successful self-test, power down the switch and disconnect the power cabling.

The switch is now ready for installation on its final location.