



Chipsmall Limited consists of a professional team with an average of over 10 year of expertise in the distribution of electronic components. Based in Hongkong, we have already established firm and mutual-benefit business relationships with customers from,Europe,America and south Asia,supplying obsolete and hard-to-find components to meet their specific needs.

With the principle of “Quality Parts,Customers Priority,Honest Operation,and Considerate Service”,our business mainly focus on the distribution of electronic components. Line cards we deal with include Microchip,ALPS,ROHM,Xilinx,Pulse,ON,Everlight and Freescale. Main products comprise IC,Modules,Potentiometer,IC Socket,Relay,Connector.Our parts cover such applications as commercial,industrial, and automotives areas.

We are looking forward to setting up business relationship with you and hope to provide you with the best service and solution. Let us make a better world for our industry!



Contact us

Tel: +86-755-8981 8866 Fax: +86-755-8427 6832

Email & Skype: info@chipsmall.com Web: www.chipsmall.com

Address: A1208, Overseas Decoration Building, #122 Zhenhua RD., Futian, Shenzhen, China



NPN Silicon AF Transistor

- For general AF applications
- High collector current
- High current gain
- Low collector-emitter saturation voltage
- Pb-free (RoHS compliant) package
- Qualified according AEC Q101

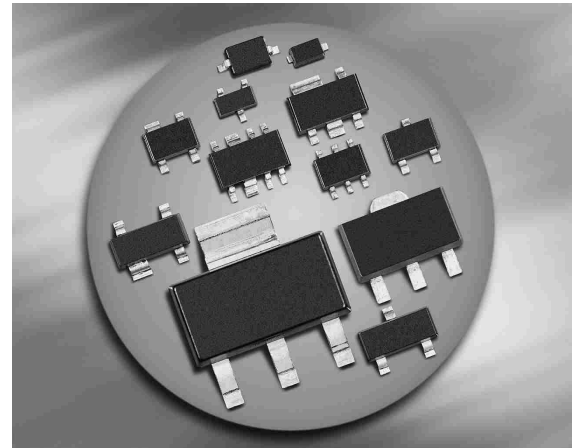

Type	Marking	Pin Configuration						Package
		1 = B	2 = E	3 = C	-	-	-	
BC817K-16	6As	1 = B	2 = E	3 = C	-	-	-	SOT23
BC817K-16W	6As	1 = B	2 = E	3 = C	-	-	-	SOT323
BC817K-25	6Bs	1 = B	2 = E	3 = C	-	-	-	SOT23
BC817K-25W	6Bs	1 = B	2 = E	3 = C	-	-	-	SOT323
BC817K-40	6Cs	1 = B	2 = E	3 = C	-	-	-	SOT23
BC817K-40W	6Cs	1 = B	2 = E	3 = C	-	-	-	SOT323
BC818K-16W	6Es	1 = B	2 = E	3 = C	-	-	-	SOT323
BC818K-40	6Gs	1 = B	2 = E	3 = C	-	-	-	SOT23

Maximum Ratings

Parameter	Symbol	Value	Unit
Collector-emitter voltage BC817... BC818...	V_{CEO}	45 25	V
Collector-base voltage BC817... BC818...	V_{CBO}	50 30	
Emitter-base voltage	V_{EBO}	5	
Collector current	I_C	500	mA
Peak collector current	I_{CM}	1000	
Base current	I_B	100	
Peak base current	I_{BM}	200	
Total power dissipation- $T_S \leq 115\text{ °C}$, BC817K, BC818K $T_S \leq 130\text{ °C}$, BC817KW, BC818KW	P_{tot}	500 250	mW
Junction temperature	T_j	150	°C
Storage temperature	T_{stg}	-65 ... 150	

Thermal Resistance

Parameter	Symbol	Value	Unit
Junction - soldering point ¹⁾ BC817K, BC818K BC817KW, BC818KW	R_{thJS}	≤ 70 ≤ 80	K/W

¹For calculation of R_{thJA} please refer to Application Note AN077 (Thermal Resistance Calculation)

Electrical Characteristics at $T_A = 25^\circ\text{C}$, unless otherwise specified

Parameter	Symbol	Values			Unit
		min.	typ.	max.	
DC Characteristics					
Collector-emitter breakdown voltage $I_C = 10\text{ mA}$, $I_B = 0$, BC817... $I_C = 10\text{ mA}$, $I_B = 0$, BC818...	$V_{(BR)CEO}$	45 25	- -	- -	V
Collector-base breakdown voltage $I_C = 10\text{ }\mu\text{A}$, $I_E = 0$, BC817... $I_C = 10\text{ }\mu\text{A}$, $I_E = 0$, BC818...	$V_{(BR)CBO}$	50 30	- -	- -	-
Emitter-base breakdown voltage $I_E = 10\text{ }\mu\text{A}$, $I_C = 0$	$V_{(BR)EBO}$	5	-	-	V
Collector-base cutoff current $V_{CB} = 25\text{ V}$, $I_E = 0$ $V_{CB} = 25\text{ V}$, $I_E = 0$, $T_A = 150^\circ\text{C}$	I_{CBO}	- -	- -	0.1 50	μA
Emitter-base cutoff current $V_{EB} = 4\text{ V}$, $I_C = 0$	I_{EBO}	-	-	100	nA
DC current gain ¹⁾ $I_C = 100\text{ mA}$, $V_{CE} = 1\text{ V}$, h_{FE} -grp.16 $I_C = 100\text{ mA}$, $V_{CE} = 1\text{ V}$, h_{FE} -grp.25 $I_C = 100\text{ mA}$, $V_{CE} = 1\text{ V}$, h_{FE} -grp.40 $I_C = 500\text{ mA}$, $V_{CE} = 1\text{ V}$, all h_{FE} -grps.	h_{FE}	100 160 250 40	160 250 350 -	250 400 630 -	-
Collector-emitter saturation voltage ¹⁾ $I_C = 500\text{ mA}$, $I_B = 50\text{ mA}$	V_{CEsat}	-	-	0.7	V
Base emitter saturation voltage ¹⁾ $I_C = 500\text{ mA}$, $I_B = 50\text{ mA}$	V_{BEsat}	-	-	1.2	

¹⁾Pulse test: $t < 300\mu\text{s}$; $D < 2\%$

Electrical Characteristics at $T_A = 25^\circ\text{C}$, unless otherwise specified

Parameter	Symbol	Values			Unit
		min.	typ.	max.	
AC Characteristics					
Transition frequency $I_C = 50\text{ mA}, V_{CE} = 5\text{ V}, f = 100\text{ MHz}$	f_T	-	170	-	MHz
Collector-base capacitance $V_{CB} = 10\text{ V}, f = 1\text{ MHz}$	C_{cb}	-	3	-	pF
Emitter-base capacitance $V_{EB} = 0.5\text{ V}, f = 1\text{ MHz}$	C_{eb}	-	40	-	

DC current gain $h_{FE} = f(I_C)$

$V_{CE} = 1\text{ V}$

$h_{FE}\text{-grp.16}$

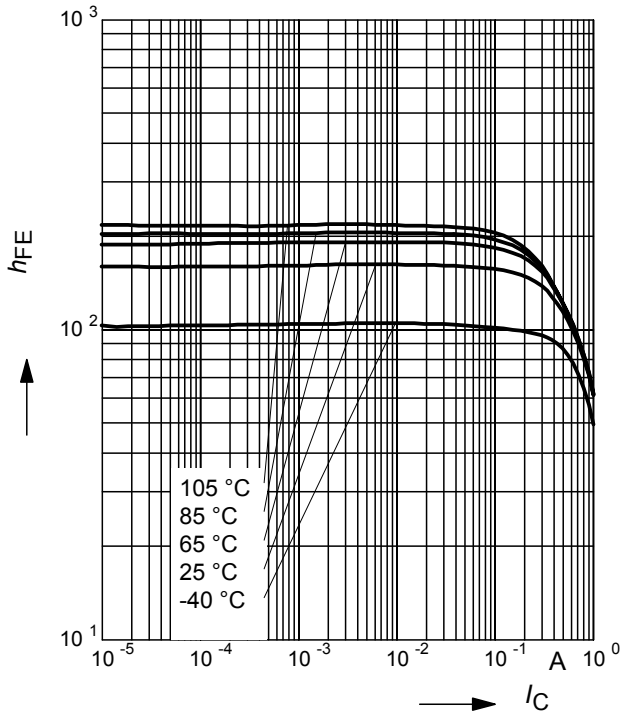

DC current gain $h_{FE} = f(I_C)$

$V_{CE} = 1\text{ V}$

$h_{FE}\text{-grp.25}$

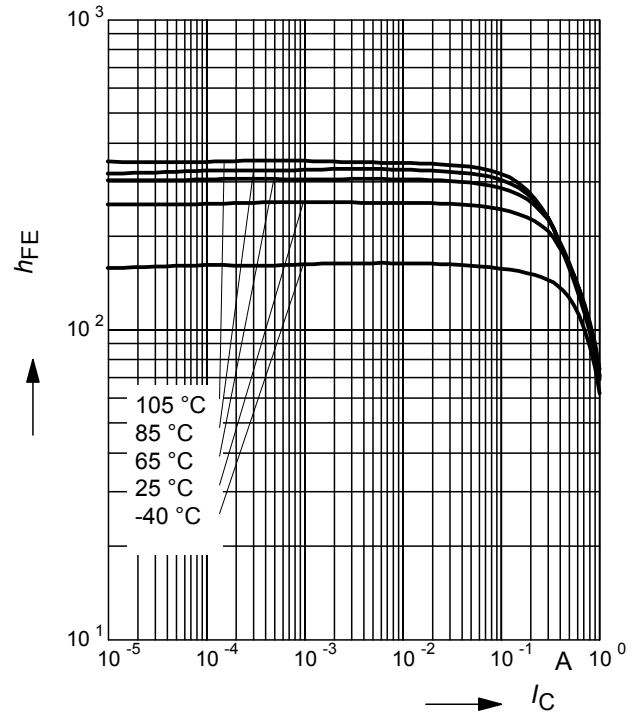

DC current gain $h_{FE} = f(I_C)$

$V_{CE} = 1\text{ V}$

$h_{FE}\text{-grp.40}$

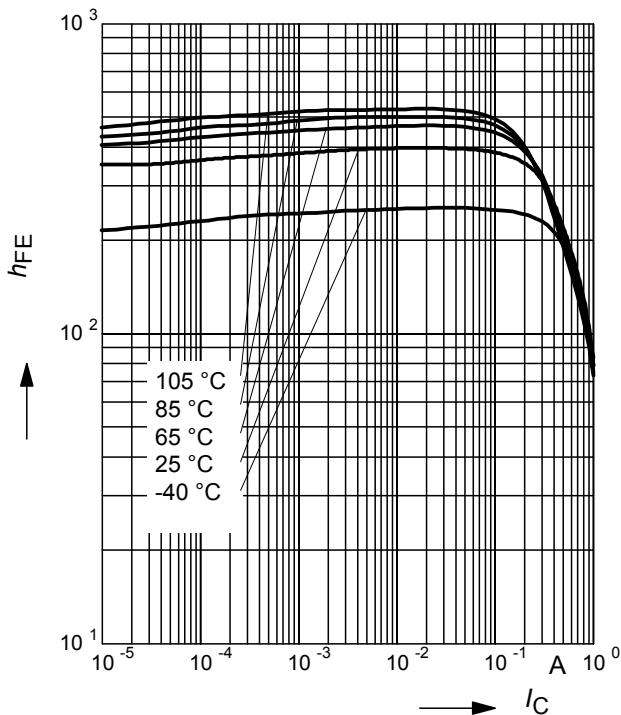

Collector-emitter saturation voltage

$I_C = f(V_{CEsat}), h_{FE} = 10$

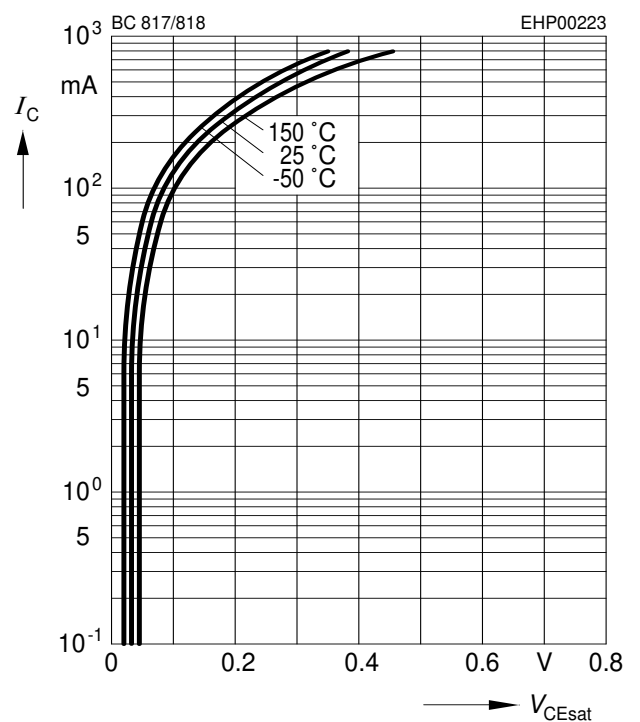

Base-emitter saturation voltage

$I_C = f(V_{BEsat}), h_{FE} = 10$

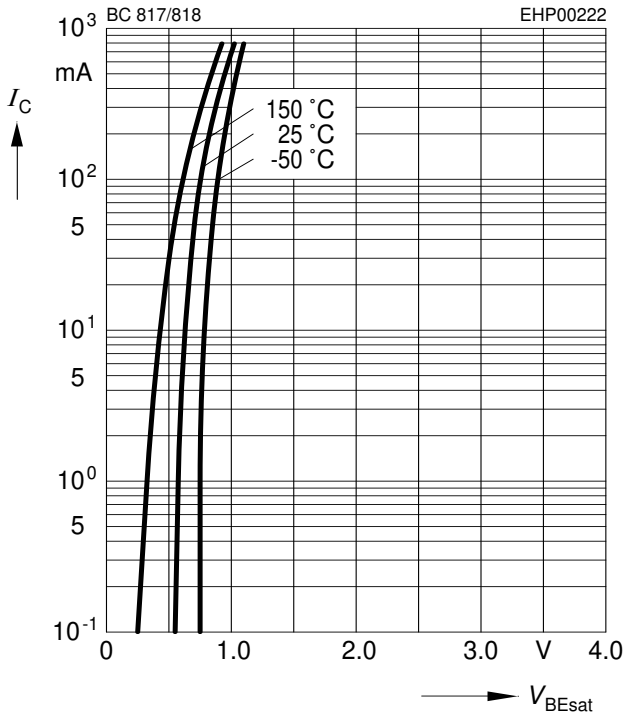

Collector cutoff current $I_{CBO} = f(T_A)$

$V_{CBO} = 25 V$

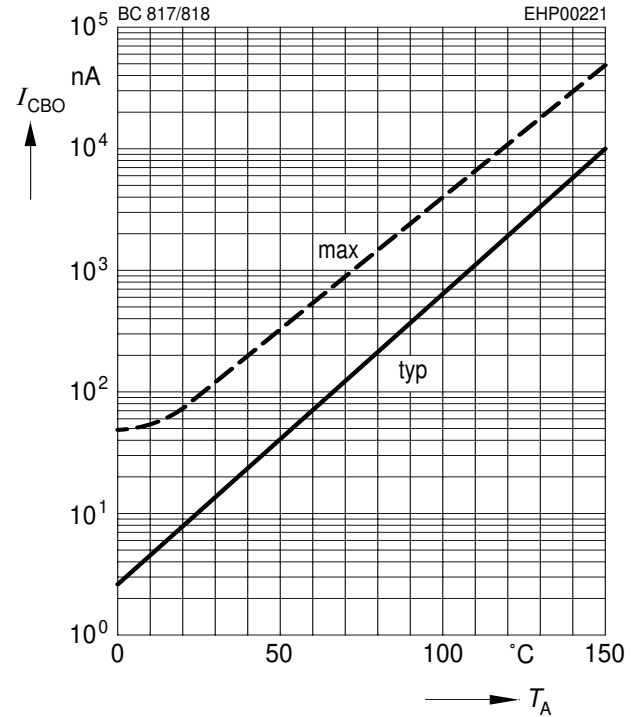

Transition frequency $f_T = f(I_C)$

$V_{CE} = \text{parameter in V}, f = 2 \text{ GHz}$

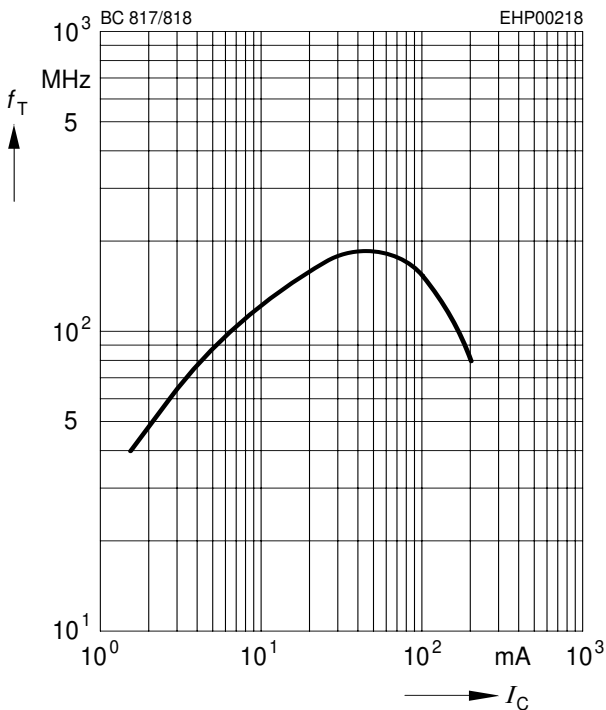

Collector-base capacitance $C_{cb} = f(V_{CB})$

Emitter-base capacitance $C_{eb} = f(V_{EB})$

BC817K, BC818K

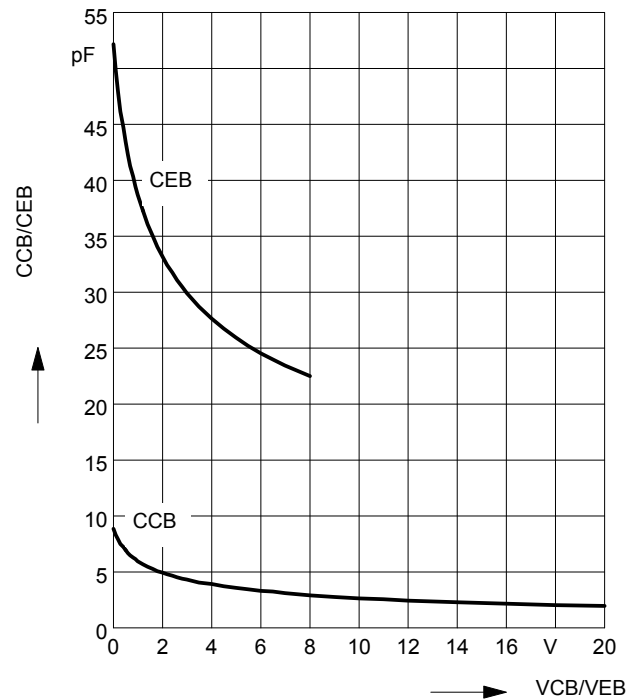

Total power dissipation $P_{tot} = f(T_S)$

BC817K, BC818K

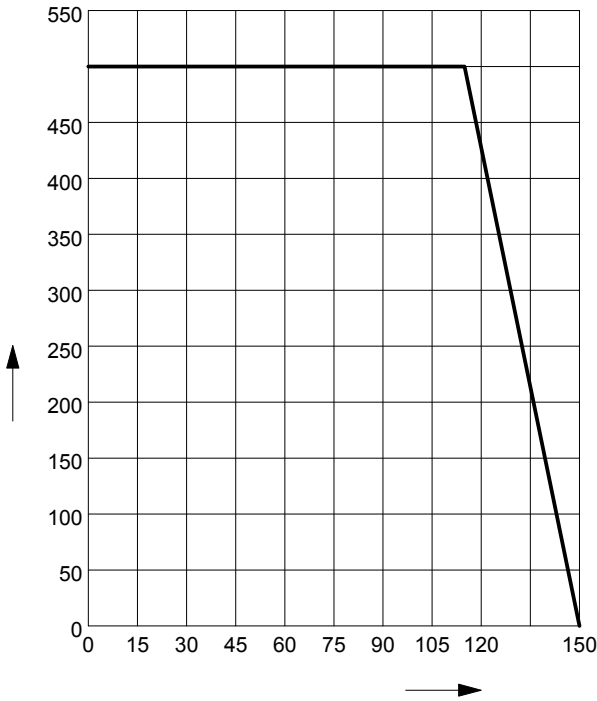

Total power dissipation $P_{tot} = f(T_S)$

BC817KW, BC818KW

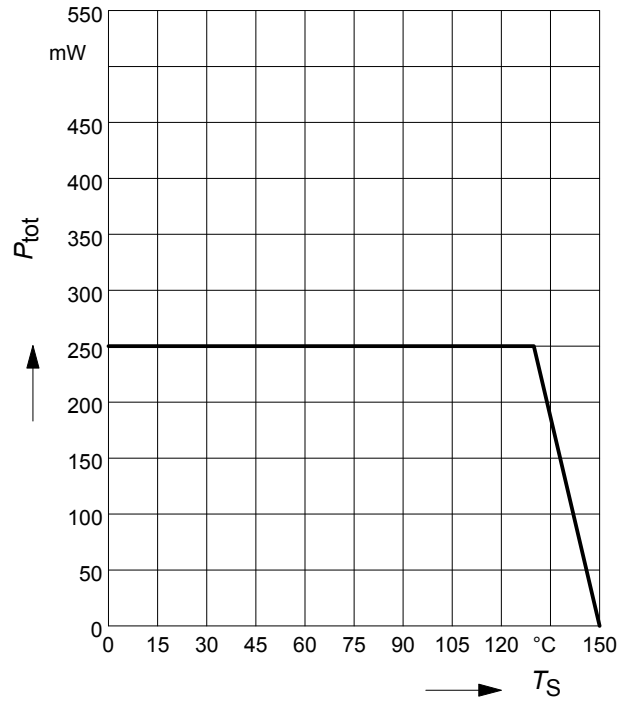

Permissible Pulse Load $R_{thJS} = f(t_p)$

BC817K, BC818K

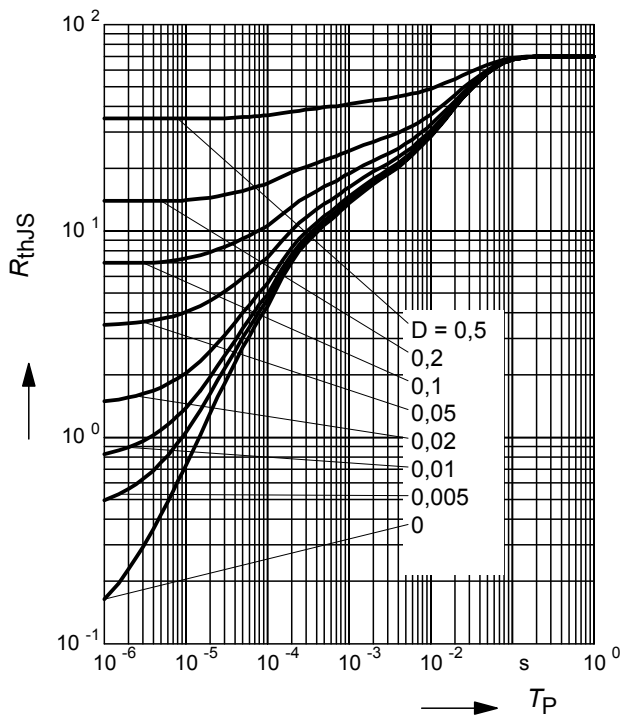

Permissible Pulse Load

$P_{totmax}/P_{totDC} = f(t_p)$

BC817K, BC818K

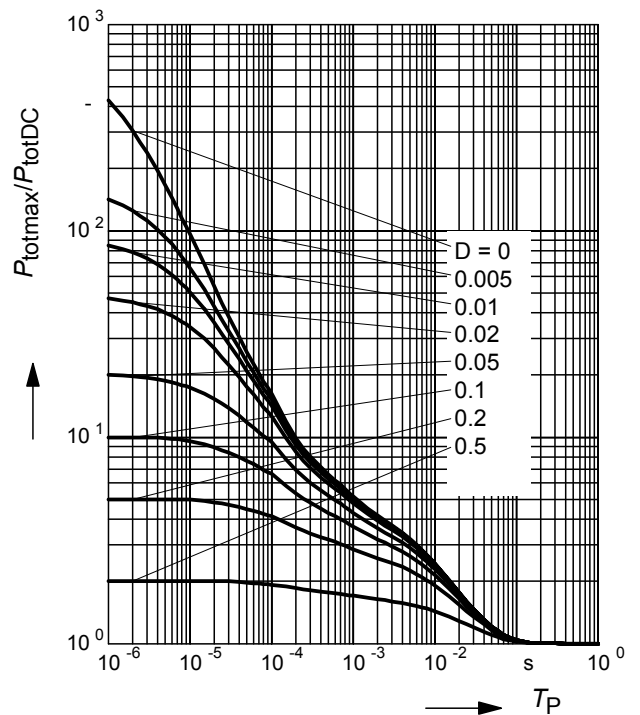

Permissible Puls Load $R_{thJS} = f(t_p)$

BC817KW, BC818KW

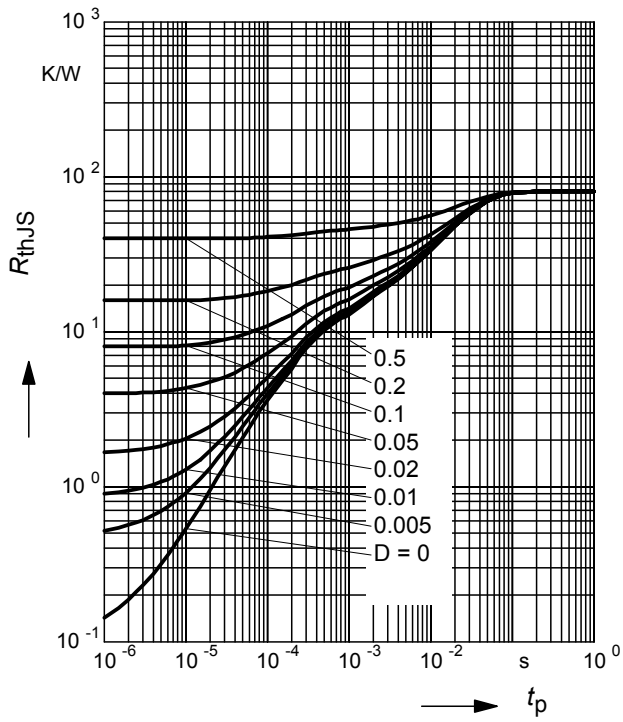

Permissible Pulse Load

$P_{totmax}/P_{totDC} = f(t_p)$

BC817KW, BC818KW

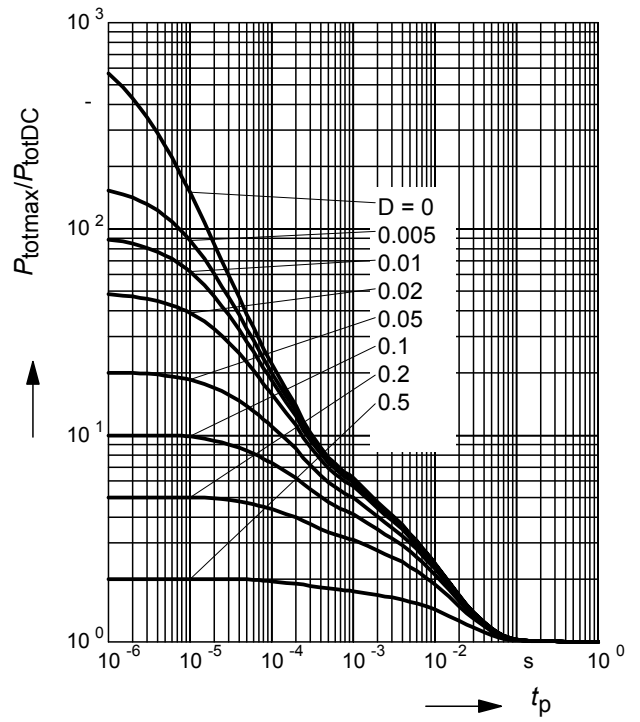

Package Outline

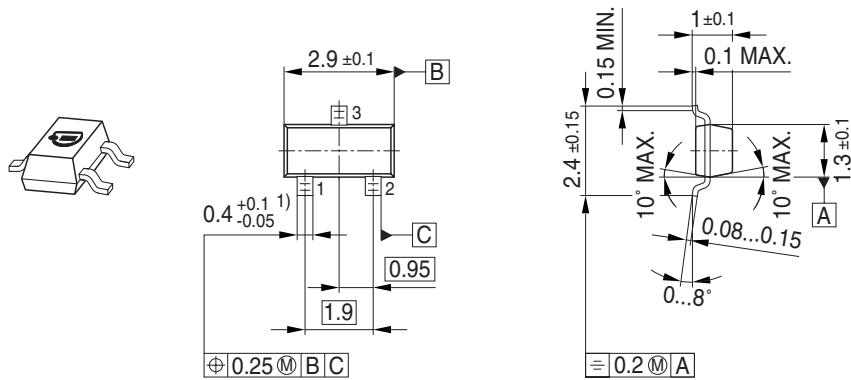

1) Lead width can be 0.6 max. in dambar area

Foot Print

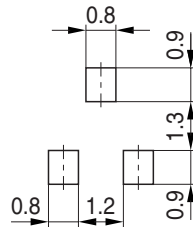

Marking Layout (Example)

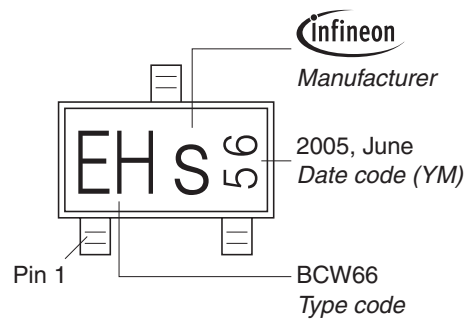

Standard Packing

Reel \varnothing 180 mm = 3.000 Pieces/Reel
 Reel \varnothing 330 mm = 10.000 Pieces/Reel

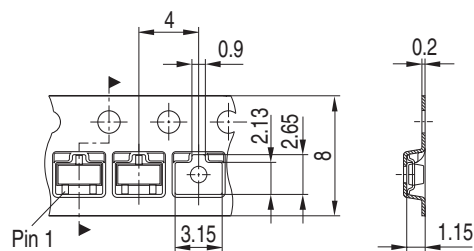

Package Outline

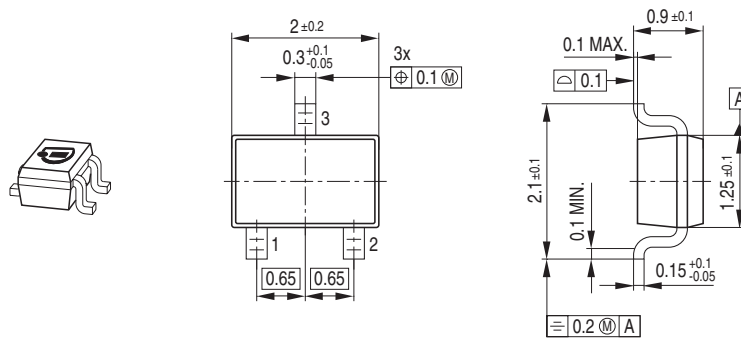

Foot Print

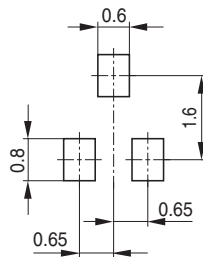

Marking Layout (Example)

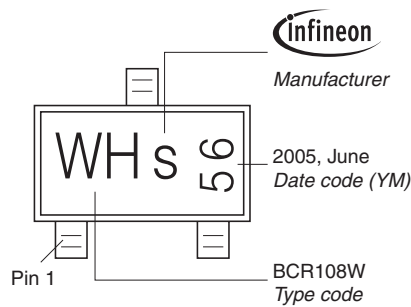

Standard Packing

Reel ø180 mm = 3.000 Pieces/Reel
 Reel ø330 mm = 10.000 Pieces/Reel

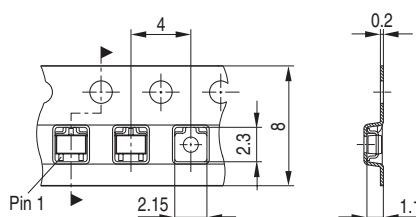

Edition 2009-11-16

**Published by
Infineon Technologies AG
81726 Munich, Germany**

**© 2009 Infineon Technologies AG
All Rights Reserved.**

Legal Disclaimer

The information given in this document shall in no event be regarded as a guarantee of conditions or characteristics. With respect to any examples or hints given herein, any typical values stated herein and/or any information regarding the application of the device, Infineon Technologies hereby disclaims any and all warranties and liabilities of any kind, including without limitation, warranties of non-infringement of intellectual property rights of any third party.

Information

For further information on technology, delivery terms and conditions and prices, please contact the nearest Infineon Technologies Office (www.infineon.com).

Warnings

Due to technical requirements, components may contain dangerous substances. For information on the types in question, please contact the nearest Infineon Technologies Office.

Infineon Technologies components may be used in life-support devices or systems only with the express written approval of Infineon Technologies, if a failure of such components can reasonably be expected to cause the failure of that life-support device or system or to affect the safety or effectiveness of that device or system. Life support devices or systems are intended to be implanted in the human body or to support and/or maintain and sustain and/or protect human life. If they fail, it is reasonable to assume that the health of the user or other persons may be endangered.