



Chipsmall Limited consists of a professional team with an average of over 10 year of expertise in the distribution of electronic components. Based in Hongkong, we have already established firm and mutual-benefit business relationships with customers from,Europe,America and south Asia,supplying obsolete and hard-to-find components to meet their specific needs.

With the principle of "Quality Parts,Customers Priority,Honest Operation,and Considerate Service",our business mainly focus on the distribution of electronic components. Line cards we deal with include Microchip,ALPS,ROHM,Xilinx,Pulse,ON,Everlight and Freescale. Main products comprise IC,Modules,Potentiometer,IC Socket,Relay,Connector.Our parts cover such applications as commercial,industrial, and automotives areas.

We are looking forward to setting up business relationship with you and hope to provide you with the best service and solution. Let us make a better world for our industry!



## Contact us

Tel: +86-755-8981 8866 Fax: +86-755-8427 6832

Email & Skype: info@chipsmall.com Web: www.chipsmall.com

Address: A1208, Overseas Decoration Building, #122 Zhenhua RD., Futian, Shenzhen, China





# BCM<sup>®</sup> Bus Converter

## BCM6123x60E10A5yzz



### Fixed Ratio DC-DC Converter

#### Features & Benefits

- Up to 150A continuous secondary current
- Up to 2206 W/in<sup>3</sup> power density
- 97.6% peak efficiency
- 2,250V<sub>DC</sub> isolation
- Parallel operation for multi-kW arrays
- OV, OC, UV, short circuit and thermal protection
- 6123 through-hole ChiP package
  - 2.402" x 0.990" x 0.286"  
(61.00mm x 25.14mm x 7.26mm)
- PMBus<sup>™</sup> management interface\*

#### Typical Applications

- High End Computing Systems
- Automated Test Equipment
- Industrial Systems
- High Density Power Supplies
- Communications Systems
- Transportation

#### Product Ratings

|                                       |                                |
|---------------------------------------|--------------------------------|
| $V_{PRI} = 54V (36 - 60V)$            | $I_{SEC} = \text{up to } 150A$ |
| $V_{SEC} = 9V (6 - 10V)$<br>(NO LOAD) | $K = 1/6$                      |

#### Product Description

The VI Chip<sup>®</sup> Bus Converter (BCM<sup>®</sup>) is a high efficiency Sine Amplitude Converter<sup>™</sup> (SAC<sup>™</sup>), operating from a 36 to 60V<sub>DC</sub> primary bus to deliver an isolated, ratiometric secondary voltage from 6 to 10 V<sub>DC</sub>.

The BCM6123x60E10A5yzz offers low noise, fast transient response, and industry leading efficiency and power density. In addition, it provides an AC impedance beyond the bandwidth of most downstream regulators, allowing input capacitance normally located at the input of a POL regulator to be located at the primary side of the BCM module. With a primary to secondary K factor of 1/6, that capacitance value can be reduced by a factor of 36x, resulting in savings of board area, material and total system cost.

Leveraging the thermal and density benefits of Vicor's ChiP packaging technology, the BCM module offers flexible thermal management options with very low top and bottom side thermal impedances. Thermally-adept ChiP-based power components, enable customers to achieve low cost power system solutions with previously unattainable system size, weight and efficiency attributes, quickly and predictably.

\*When used with D44TL1A0 and I13TL1A0 chipset

Typical Application

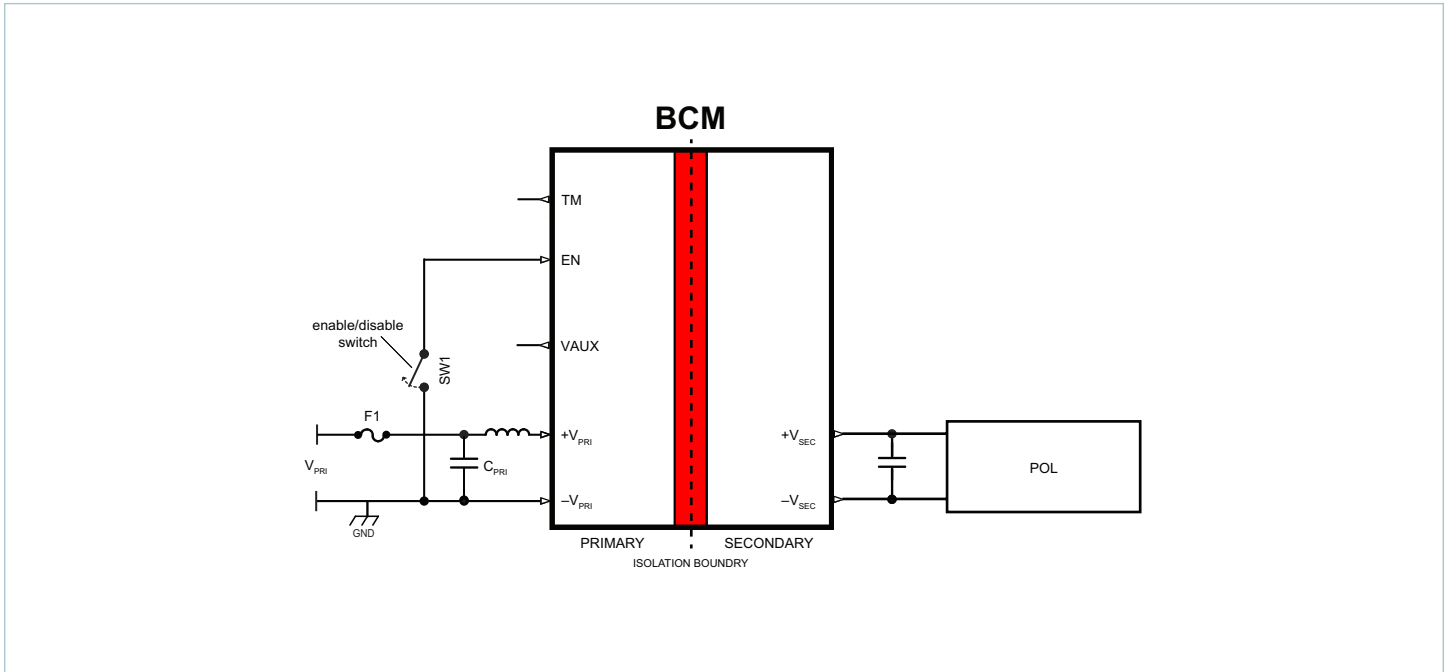

BCM6123x60E10A5y00 at Point of load

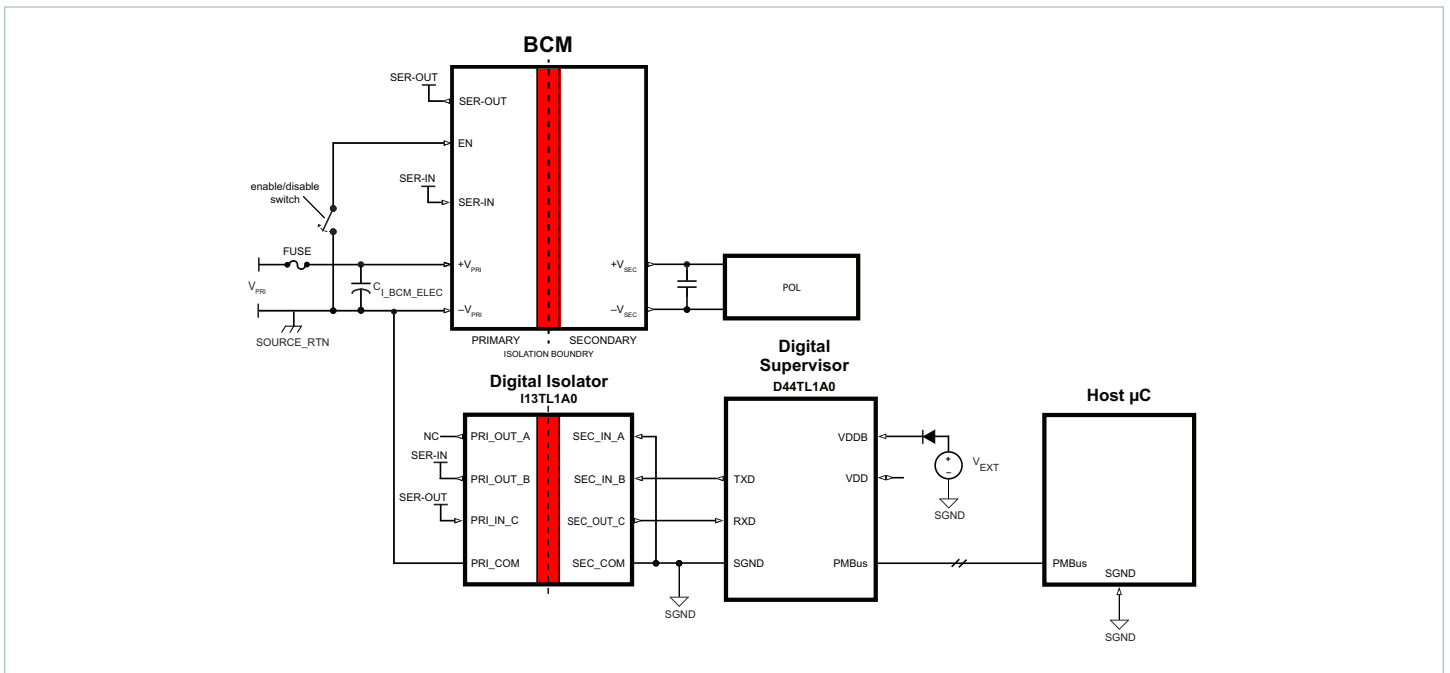

BCM6123x60E10A5y01 at Point of load

Pin Configuration

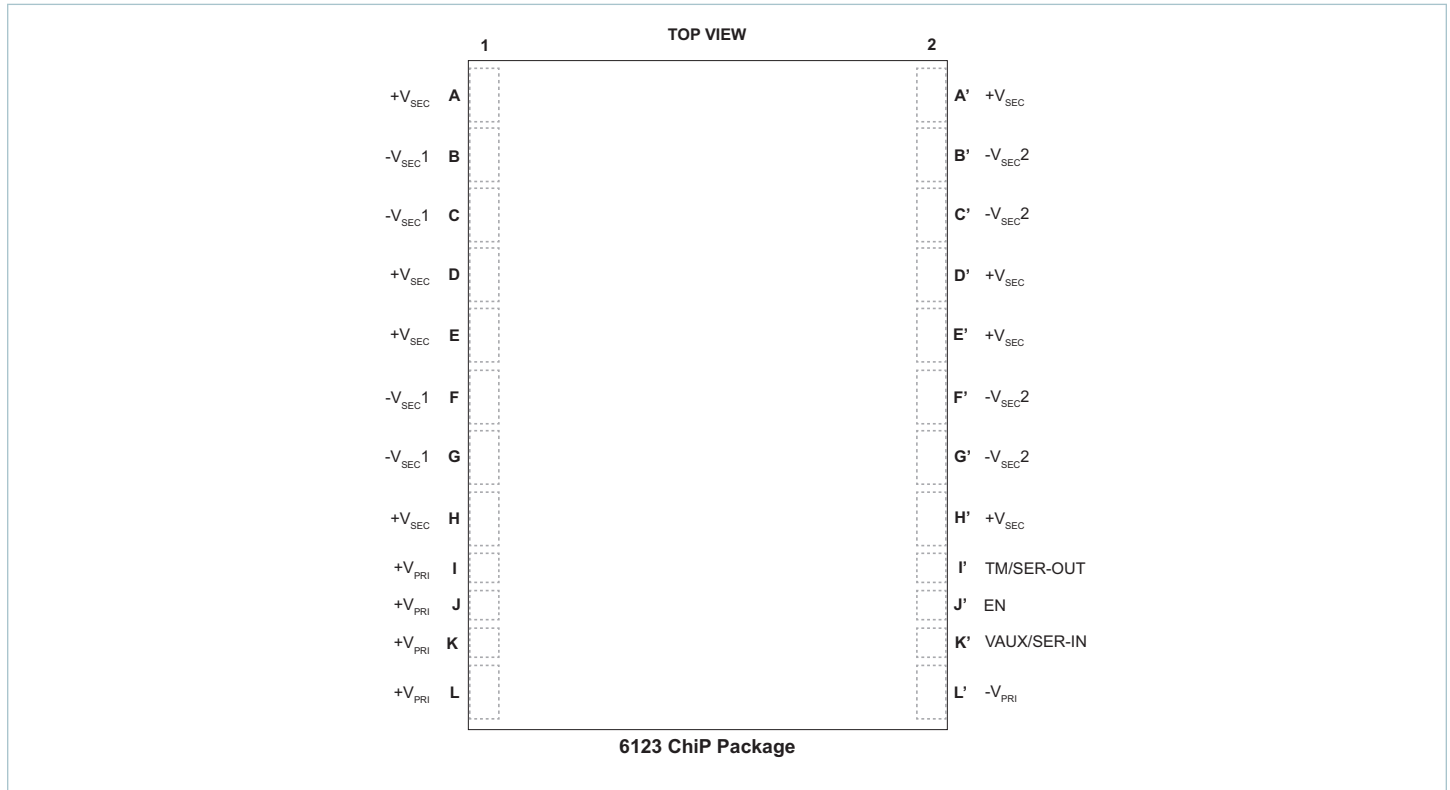

Pin Descriptions

| Power Pins                           |                    |                        |  |
|--------------------------------------|--------------------|------------------------|--|
| Pin Number                           | Signal Name        | Type                   | Function   |
| I1, J1, K1, L1                       | +V <sub>PRI</sub>  | PRIMARY POWER          | Positive primary transformer power terminal                        |
| L'2                                  | -V <sub>PRI</sub>  | PRIMARY POWER RETURN   | Negative primary transformer power terminal                        |
| A1, D1, E1, H1, A'2, D'2, E'2, H'2   | +V <sub>SEC</sub>  | SECONDARY POWER        | Positive secondary transformer power terminal                      |
| B1, C1, F1, G1<br>B'2, C'2, F'2, G'2 | -V <sub>SEC*</sub> | SECONDARY POWER RETURN | Negative secondary transformer power terminal                      |
| Analog Control Signal Pins           |                    |                        |  |
| Pin Number                           | Signal Name        | Type                   | Function   |
| I'2                                  | TM                 | OUTPUT                 | Temperature Monitor; primary side referenced signals               |
| J'2                                  | EN                 | INPUT                  | Enables and disables power supply; primary side referenced signals |
| K'2                                  | VAUX               | OUTPUT                 | Auxiliary Voltage Source; primary side referenced signals          |
| PMBus Control Signal Pins            |                    |                        |  |
| Pin Number                           | Signal Name        | Type                   | Function   |
| I'2                                  | SER-OUT            | OUTPUT                 | UART transmit pin; Primary side referenced signals                 |
| J'2                                  | EN                 | INPUT                  | Enables and disables power supply; Primary side referenced signals |
| K'2                                  | SER-IN             | INPUT                  | UART receive pin; Primary side referenced signals                  |

\*For proper operation an external low impedance connection must be made between listed -V<sub>SEC1</sub> and -V<sub>SEC2</sub> terminals.

## Part Ordering Information

| Product Function     | Package Size     | Package Mounting                | Max Primary Input Voltage | Range Identifier | Max Secondary Voltage | Secondary Output Current | Temperature Grade                                    | Option   |
|----------------------|------------------|---------------------------------|---------------------------|------------------|-----------------------|--------------------------|--|--|
| BCM                  | 6123             | x                               | 60                        | E                | 10                    | A5                       | y  | zz   |
| Bus Converter Module | 61 = L<br>23 = W | <b>T</b> = TH<br><b>S</b> = SMT | 60V                       | 36 – 60V         | 10V<br>No Load        | 150A                     | <b>T</b> = -40°C – 125°C<br><b>M</b> = -55°C – 125°C | <b>00</b> = Analog Ctrl<br><b>01</b> = PMBus Ctrl<br><b>OR</b> = Reversible Analog Ctrl<br><b>OP</b> = Reversible PMBus Ctrl |

All products shipped in JEDEC standard high profile (0.400" thick) trays (JEDEC Publication 95, Design Guide 4.10).

## Standard Models

| Product Function | Package Size | Package Mounting | Max Primary Input Voltage | Range Identifier | Max Secondary Voltage | Secondary Output Current | Temperature Grade | Option |
|------------------|--------------|------------------|---------------------------|------------------|-----------------------|--------------------------|-------------------|--------|
| BCM              | 6123         | T                | 60                        | E                | 10                    | A5                       | T                 | 00     |
| BCM              | 6123         | T                | 60                        | E                | 10                    | A5                       | T                 | 01     |

## Absolute Maximum Ratings

The absolute maximum ratings below are stress ratings only. Operation at or beyond these maximum ratings can cause permanent damage to the device.

| Parameter  | Comments | Min  | Max | Unit |
|--|----------|------|-----|------|
| +V <sub>PRI_DC</sub> to -V <sub>PRI_DC</sub>                       |          | -1   | 80  | V    |
| V <sub>PRI_DC</sub> or V <sub>SEC_DC</sub> slew rate (operational) |          |      | 1   | V/μs |
| +V <sub>SEC_DC</sub> to -V <sub>SEC_DC</sub>                       |          | -1   | 15  | V    |
| TM/SER-OUT to -V <sub>PRI_DC</sub>                                 |          | -0.3 | 4.6 | V    |
| EN to -V <sub>PRI_DC</sub>   |          |      | 5.5 | V    |
| VAUX/SER-IN to -V <sub>PRI_DC</sub>                                |          |      | 4.6 | V    |

Electrical Specifications

Specifications apply over all line and load conditions, unless otherwise noted; **Boldface** specifications apply over the temperature range of  $-40^{\circ}\text{C} \leq T_{\text{INTERNAL}} \leq 125^{\circ}\text{C}$  (T-Grade); All other specifications are at  $T_{\text{INTERNAL}} = 25^{\circ}\text{C}$  unless otherwise noted.

| Attribute   | Symbol                       | Conditions / Notes   | Min         | Typ  | Max         | Unit       |
|---|------------------------------|--|-------------|------|-------------|------------|
| <b>General Powetrain PRIMARY to SECONDARY Specification (Forward Direction)</b> |                              |  |             |      |             |            |
| Primary Input Voltage range, continuous   | $V_{\text{PRI\_DC}}$         |  | <b>36</b>   |      | <b>60</b>   | V          |
| $V_{\text{PRI}}$ $\mu$ Controller   | $V_{\mu\text{C\_ACTIVE}}$    | $V_{\text{PRI\_DC}}$ voltage where $\mu\text{C}$ is initialized, (ie VAUX = Low, powertrain inactive)                            |             |      | 14          | V          |
| PRI to SEC Input Quiescent Current  | $I_{\text{PRI\_Q}}$          | Disabled, EN Low, $V_{\text{PRI\_DC}} = 54\text{V}$<br>$T_{\text{INTERNAL}} \leq 100^{\circ}\text{C}$                            |             | 5    | 10          | mA         |
| PRI to SEC No Load Power Dissipation  | $P_{\text{PRI\_NL}}$         | $V_{\text{PRI\_DC}} = 54\text{V}$ , $T_{\text{INTERNAL}} = 25^{\circ}\text{C}$   |             | 7.2  | 9           | W          |
|   |                              | $V_{\text{PRI\_DC}} = 54\text{V}$  | <b>5</b>    |      | <b>14</b>   |            |
|   |                              | $V_{\text{PRI\_DC}} = 36\text{V}$ to $60\text{V}$ , $T_{\text{INTERNAL}} = 25^{\circ}\text{C}$                                   |             |      | 12          |            |
|   |                              | $V_{\text{PRI\_DC}} = 36\text{V}$ to $60\text{V}$  |             |      | <b>17</b>   |            |
| PRI to SEC Inrush Current Peak  | $I_{\text{PRI\_INR\_PK}}$    | $V_{\text{PRI\_DC}} = 60\text{V}$ , $C_{\text{SEC\_EXT}} = 6000\mu\text{F}$ , $R_{\text{LOAD\_SEC}} = 20\%$ of full load current |             | 30   |             | A          |
|   |                              | $T_{\text{INTERNAL}} \leq 100^{\circ}\text{C}$   |             |      | 35          |            |
| DC Primary Input Current  | $I_{\text{PRI\_IN\_DC}}$     | At $I_{\text{SEC\_OUT\_DC}} = 150\text{A}$ , $T_{\text{INTERNAL}} \leq 100^{\circ}\text{C}$                                      |             |      | 25.5        | A          |
| Transformation Ratio  | K                            | Primary to secondary, $K = V_{\text{SEC\_DC}} / V_{\text{PRI\_DC}}$ , at no load   |             | 1/6  |             | V/V        |
| Secondary Output Current (continuous)   | $I_{\text{SEC\_OUT\_DC}}$    |  |             |      | 150         | A          |
| Secondary Output Current (pulsed)   | $I_{\text{SEC\_OUT\_PULSE}}$ | 10ms pulse, 25% Duty cycle, $I_{\text{SEC\_OUT\_AVG}} \leq 50\%$ rated $I_{\text{SEC\_OUT\_DC}}$                                 |             |      | 180         | A          |
| PRI to SEC Efficiency (ambient)   | $\eta_{\text{AMB}}$          | $V_{\text{PRI\_DC}} = 54\text{V}$ , $I_{\text{SEC\_OUT\_DC}} = 150\text{A}$  | 96.1        | 96.7 |             | %          |
|   |                              | $V_{\text{PRI\_DC}} = 36\text{V}$ to $60\text{V}$ , $I_{\text{SEC\_OUT\_DC}} = 150\text{A}$                                      | 94.5        |      |             |            |
|   |                              | $V_{\text{PRI\_DC}} = 54\text{V}$ , $I_{\text{SEC\_OUT\_DC}} = 75\text{A}$   | 96.9        | 97.6 |             |            |
| PRI to SEC Efficiency (hot)   | $\eta_{\text{HOT}}$          | $V_{\text{PRI\_DC}} = 54\text{V}$ , $I_{\text{SEC\_OUT\_DC}} = 150\text{A}$  | 95.4        | 96   |             | %          |
| PRI to SEC Efficiency (over load range)   | $\eta_{20\%}$                | $30\text{A} < I_{\text{SEC\_OUT\_DC}} < 150\text{A}$   | 90          |      |             | %          |
| PRI to SEC Output Resistance  | $R_{\text{SEC\_COLD}}$       | $V_{\text{PRI\_DC}} = 54\text{V}$ , $I_{\text{SEC\_OUT\_DC}} = 150\text{A}$ , $T_{\text{INTERNAL}} = -40^{\circ}\text{C}$        | 0.9         | 1.2  | 1.5         | m $\Omega$ |
|   | $R_{\text{SEC\_AMB}}$        | $V_{\text{PRI\_DC}} = 54\text{V}$ , $I_{\text{SEC\_OUT\_DC}} = 150\text{A}$  | 1.2         | 1.6  | 2           |            |
|   | $R_{\text{SEC\_HOT}}$        | $V_{\text{PRI\_DC}} = 54\text{V}$ , $I_{\text{SEC\_OUT\_DC}} = 150\text{A}$ , $T_{\text{INTERNAL}} = 100^{\circ}\text{C}$        | 1.6         | 2    | 2.2         |            |
| Switching Frequency   | $F_{\text{SW}}$              | Frequency of the Output Voltage Ripple = $2 \times F_{\text{SW}}$  | <b>0.85</b> | 0.90 | <b>0.95</b> | MHz        |
| Secondary Output Voltage Ripple   | $V_{\text{SEC\_OUT\_PP}}$    | $C_{\text{SEC\_EXT}} = 0\mu\text{F}$ , $I_{\text{SEC\_OUT\_DC}} = 150\text{A}$ , $V_{\text{PRI\_DC}} = 54\text{V}$ , 20MHz BW    |             | 140  |             | mV         |
|   |                              | $T_{\text{INTERNAL}} \leq 100^{\circ}\text{C}$   |             |      | 200         |            |
| Primary Input Leads Inductance (Parasitic)                                      | $L_{\text{PRI\_IN\_LEADS}}$  | Frequency 2.5MHz (double switching frequency), Simulated lead model  |             | 6.7  |             | nH         |
| Secondary Output Leads Inductance (Parasitic)                                   | $L_{\text{SEC\_OUT\_LEADS}}$ | Frequency 2.5MHz (double switching frequency), Simulated lead model  |             | 0.64 |             | nH         |

Electrical Specifications (Cont.)

Specifications apply over all line and load conditions, unless otherwise noted; **Boldface** specifications apply over the temperature range of  $-40^{\circ}\text{C} \leq T_{\text{INTERNAL}} \leq 125^{\circ}\text{C}$  (T-Grade); All other specifications are at  $T_{\text{INTERNAL}} = 25^{\circ}\text{C}$  unless otherwise noted.

| Attribute   | Symbol                       | Conditions / Notes   | Min        | Typ  | Max         | Unit               |
|---|------------------------------|--|------------|------|-------------|--------------------|
| <b>General Powetrain PRIMARY to SECONDARY Specification (Forward Direction) Cont.</b> |                              |  |            |      |             |                    |
| Effective Primary Capacitance (Internal)  | $C_{\text{PRI\_INT}}$        | Effective Value at $54V_{\text{PRI\_DC}}$  |            | 11.2 |             | $\mu\text{F}$      |
| Effective Secondary Capacitance (Internal)  | $C_{\text{SEC\_INT}}$        | Effective Value at $9V_{\text{SEC\_DC}}$   |            | 202  |             | $\mu\text{F}$      |
| Effective Secondary Output Capacitance (External)                                     | $C_{\text{SEC\_OUT\_EXT}}$   | Excessive capacitance may drive module into SC protection  |            |      | <b>6000</b> | $\mu\text{F}$      |
| Effective Secondary Output Capacitance (External)                                     | $C_{\text{SEC\_OUT\_AEXT}}$  | $C_{\text{SEC\_OUT\_AEXT Max}} = N * 0.5 * C_{\text{SEC\_OUT\_EXT Max}}$ , where N = the number of units in parallel       |            |      |             |                    |
| <b>Powertrain Protection PRIMARY to SECONDARY (Forward Direction)</b>                 |                              |  |            |      |             |                    |
| Auto Restart Time   | $t_{\text{AUTO\_RESTART}}$   | Startup into a persistent fault condition. Non-Latching fault detection given $V_{\text{PRI\_DC}} > V_{\text{PRI\_UVLO+}}$ | <b>490</b> |      | <b>560</b>  | ms                 |
| Primary Overvoltage Lockout Threshold   | $V_{\text{PRI\_OVLO+}}$      |  | <b>63</b>  | 67   | <b>71</b>   | V                  |
| Primary Overvoltage Recovery Threshold  | $V_{\text{PRI\_OVLO-}}$      |  | <b>61</b>  | 65   | <b>69</b>   | V                  |
| Primary Overvoltage Lockout Hysteresis  | $V_{\text{PRI\_OVLO\_HYST}}$ |  |            | 2    |             | V                  |
| Primary Overvoltage Lockout Response Time   | $t_{\text{PRI\_OVLO}}$       |  |            | 100  |             | $\mu\text{s}$      |
| Primary Soft-Start Time   | $t_{\text{PRI\_SOFT-START}}$ | From powertrain active. Fast Current limit protection disabled during Soft-Start   |            | 1    |             | ms                 |
| Secondary Output Overcurrent Trip Threshold (Analog)                                  | $I_{\text{SEC\_OUT\_OCP}}$   |  | <b>170</b> | 210  | <b>240</b>  | A                  |
| Secondary Output Overcurrent Response Time Constant                                   | $t_{\text{SEC\_OUT\_OCP}}$   | Effective internal RC filter   |            | 3    |             | ms                 |
| Secondary Output Short Circuit Protection Trip Threshold                              | $I_{\text{SEC\_OUT\_SCP}}$   |  | <b>225</b> |      |             | A                  |
| Secondary Output Short Circuit Protection Response Time                               | $t_{\text{SEC\_OUT\_SCP}}$   |  |            | 1    |             | $\mu\text{s}$      |
| Overtemperature Shutdown Threshold  | $t_{\text{OTP+}}$            | Temperature sensor located inside controller IC  | <b>125</b> |      |             | $^{\circ}\text{C}$ |

Electrical Specifications (Cont.)

Specifications apply over all line and load conditions, unless otherwise noted; **Boldface** specifications apply over the temperature range of  $-40^{\circ}\text{C} \leq T_{\text{INTERNAL}} \leq 125^{\circ}\text{C}$  (T-Grade); All other specifications are at  $T_{\text{INTERNAL}} = 25^{\circ}\text{C}$  unless otherwise noted.

| Attribute   | Symbol                         | Conditions / Notes  | Min        | Typ | Max        | Unit               |
|---|--------------------------------|---|------------|-----|------------|--------------------|
| <b>Powertrain Supervisory Limits PRIMARY to SECONDARY (Forward Direction)</b> |                                |   |            |     |            |                    |
| Primary Overvoltage Lockout Threshold   | $V_{\text{PRI\_OVLO+}}$        |   | <b>64</b>  | 66  | <b>68</b>  | V                  |
| Primary Overvoltage Recovery Threshold  | $V_{\text{PRI\_OVLO-}}$        |   | <b>60</b>  | 64  | <b>66</b>  | V                  |
| Primary Overvoltage Lockout Hysteresis  | $V_{\text{PRI\_OVLO\_HYST}}$   |   |            | 2   |            | V                  |
| Primary Overvoltage Lockout Response Time                                     | $t_{\text{PRI\_OVLO}}$         |   |            | 100 |            | $\mu\text{s}$      |
| Primary Undervoltage Lockout Threshold  | $V_{\text{PRI\_UVLO-}}$        |   | <b>26</b>  | 28  | <b>30</b>  | V                  |
| Primary Undervoltage Recovery Threshold                                       | $V_{\text{PRI\_UVLO+}}$        |   | <b>28</b>  | 30  | <b>32</b>  | V                  |
| Primary Undervoltage Lockout Hysteresis                                       | $V_{\text{PRI\_UVLO\_HYST}}$   |   |            | 2   |            | V                  |
| Primary Undervoltage Lockout Response Time                                    | $t_{\text{PRI\_UVLO}}$         |   |            | 100 |            | $\mu\text{s}$      |
| Primary Undervoltage Startup Delay  | $t_{\text{PRI\_UVLO+\_DELAY}}$ | From $V_{\text{PRI\_DC}} = V_{\text{PRI\_UVLO+}}$ to powertrain active, EN floating, (i.e One time Startup delay form application of $V_{\text{PRI\_DC}}$ to $V_{\text{SEC\_DC}}$ ) |            | 20  |            | ms                 |
| Secondary Output Overcurrent Trip Threshold (PMBus™)                          | $I_{\text{SEC\_OUT\_OCP}}$     |   | <b>192</b> | 204 | <b>216</b> | A                  |
| Secondary Output Overcurrent Response Time Constant                           | $t_{\text{SEC\_OUT\_OCP}}$     | Effective internal RC filter  |            | 3   |            | ms                 |
| Overtemperature Shutdown Threshold  | $t_{\text{OTP+}}$              | Temperature sensor located inside controller IC   | <b>125</b> |     |            | $^{\circ}\text{C}$ |
| Overtemperature Recovery Threshold  | $t_{\text{OTP-}}$              |   | 105        | 110 | 115        | $^{\circ}\text{C}$ |
| Undertemperature Shutdown Threshold   | $t_{\text{UTP}}$               | Temperature sensor located inside controller IC; Protection not available for M-Grade units.  |            |     | -45        | $^{\circ}\text{C}$ |
| Undertemperature Restart Time   | $t_{\text{UTP\_RESTART}}$      | Startup into a persistent fault condition. Non-Latching fault detection given $V_{\text{PRI\_DC}} > V_{\text{PRI\_UVLO+}}$  |            | 3   |            | s                  |



Electrical Specifications (Cont.)

Specifications apply over all line and load conditions, unless otherwise noted; **Boldface** specifications apply over the temperature range of  $-40^{\circ}\text{C} \leq T_{\text{INTERNAL}} \leq 125^{\circ}\text{C}$  (T-Grade); All other specifications are at  $T_{\text{INTERNAL}} = 25^{\circ}\text{C}$  unless otherwise noted.

| Attribute   | Symbol                       | Conditions / Notes   | Min       | Typ  | Max         | Unit       |
|---|------------------------------|--|-----------|------|-------------|------------|
| <b>General Powetrain SECONDARY to PRIMARY Specification (Reverse Direction)</b> |                              |  |           |      |             |            |
| Secondary Input Voltage range, continuous                                       | $V_{\text{SEC\_DC}}$         |  | <b>6</b>  |      | <b>10</b>   | V          |
| SEC to PRI No Load Power Dissipation  | $P_{\text{SEC\_NL}}$         | $V_{\text{SEC\_DC}} = 9\text{V}, T_{\text{INTERNAL}} = 25^{\circ}\text{C}$   |           | 7.2  | 9           | W          |
|   |                              | $V_{\text{SEC\_DC}} = 9\text{V}$   | <b>5</b>  |      | <b>14</b>   |            |
|   |                              | $V_{\text{SEC\_DC}} = 6\text{V to } 10\text{V}, T_{\text{INTERNAL}} = 25^{\circ}\text{C}$  |           |      | 12          |            |
|   |                              | $V_{\text{SEC\_DC}} = 6\text{V to } 10\text{V}$  |           |      | <b>17</b>   |            |
| DC Secondary Input Current  | $I_{\text{SEC\_IN\_DC}}$     | At $I_{\text{PRI\_DC}} = 25\text{A}, T_{\text{INTERNAL}} \leq 100^{\circ}\text{C}$   |           |      | <b>152</b>  | A          |
| Primary Output Current (continuous)   | $I_{\text{PRI\_OUT\_DC}}$    |  |           |      | <b>25</b>   | A          |
| Primary Output Current (pulsed)   | $I_{\text{PRI\_OUT\_PULSE}}$ | 10ms pulse, 25% Duty cycle, $I_{\text{PRI\_OUT\_AVG}} \leq 50\%$ rated $I_{\text{PRI\_OUT\_DC}}$                                 |           |      | <b>30</b>   | A          |
| SEC to PRI Efficiency (ambient)   | $\eta_{\text{AMB}}$          | $V_{\text{SEC\_DC}} = 9\text{V}, I_{\text{PRI\_OUT\_DC}} = 25\text{A}$   | 96.0      | 96.5 |             | %          |
|   |                              | $V_{\text{SEC\_DC}} = 6\text{V to } 10\text{V}, I_{\text{PRI\_OUT\_DC}} = 25\text{A}$  | 93.8      |      |             |            |
|   |                              | $V_{\text{SEC\_DC}} = 9\text{V}, I_{\text{PRI\_OUT\_DC}} = 12.5\text{A}$   | 96.9      | 97.5 |             |            |
| SEC to PRI Efficiency (hot)   | $\eta_{\text{HOT}}$          | $V_{\text{SEC\_DC}} = 9\text{V}, I_{\text{PRI\_OUT\_DC}} = 25\text{A}$   | 95.4      | 95.9 |             | %          |
| SEC to PRI Efficiency (over load range)   | $\eta_{20\%}$                | $5\text{A} < I_{\text{PRI\_OUT\_DC}} < 25\text{A}$   | <b>90</b> |      |             | %          |
| SEC to PRI Output Resistance  | $R_{\text{PRI\_COLD}}$       | $V_{\text{SEC\_DC}} = 9\text{V}, I_{\text{PRI\_OUT\_DC}} = 25\text{A}, T_{\text{INTERNAL}} = -40^{\circ}\text{C}$                | 47        | 55   | 63          | m $\Omega$ |
|   | $R_{\text{PRI\_AMB}}$        | $V_{\text{SEC\_DC}} = 9\text{V}, I_{\text{PRI\_OUT\_DC}} = 25\text{A}$   | 61        | 72   | 83          |            |
|   | $R_{\text{PRI\_HOT}}$        | $V_{\text{SEC\_DC}} = 9\text{V}, I_{\text{PRI\_OUT\_DC}} = 25\text{A}, T_{\text{INTERNAL}} = 100^{\circ}\text{C}$                | 76        | 84   | 92          |            |
| Primary Output Voltage Ripple   | $V_{\text{PRI\_OUT\_PP}}$    | $C_{\text{PRI\_OUT\_EXT}} = 0\mu\text{F}, I_{\text{PRI\_OUT\_DC}} = 25\text{A}, V_{\text{SEC\_DC}} = 9\text{V}, 20\text{MHz BW}$ |           | 800  |             | mV         |
|   |                              | $T_{\text{INTERNAL}} \leq 100^{\circ}\text{C}$   |           |      | <b>1200</b> |            |

Electrical Specifications (Cont.)

Specifications apply over all line and load conditions, unless otherwise noted; **Boldface** specifications apply over the temperature range of  $-40^{\circ}\text{C} \leq T_{\text{INTERNAL}} \leq 125^{\circ}\text{C}$  (T-Grade); All other specifications are at  $T_{\text{INTERNAL}} = 25^{\circ}\text{C}$  unless otherwise noted.

| Attribute  | Symbol                          | Conditions / Notes  | Min         | Typ  | Max         | Unit          |
|--|---------------------------------|---|-------------|------|-------------|---------------|
| <b>Protection SECONDARY to PRIMARY (Reverse Direction)</b> |                                 |   |             |      |             |               |
| Effective Primary Output Capacitance (External)            | $C_{\text{PRI\_OUT\_EXT}}$      | Excessive capacitance may drive into SC protection  |             |      | <b>100</b>  | $\mu\text{F}$ |
| Secondary Overvoltage Lockout Threshold                    | $V_{\text{SEC\_OVLO+}}$         | Module latched shutdown with $V_{\text{PRI\_DC}} < V_{\text{PRI\_UVLO-R}}$  | <b>10.6</b> | 11.2 | <b>11.8</b> | V             |
| Secondary Overvoltage Lockout Response Time                | $t_{\text{PRI\_OVLO}}$          |   |             | 100  |             | $\mu\text{s}$ |
| Secondary Undervoltage Lockout Threshold                   | $V_{\text{SEC\_UVLO-}}$         | Module latched shutdown with $V_{\text{PRI\_DC}} < V_{\text{PRI\_UVLO-R}}$  | <b>4.3</b>  | 4.7  | <b>5.1</b>  | V             |
| Secondary Undervoltage Lockout Response Time               | $t_{\text{SEC\_UVLO}}$          |   |             | 100  |             | $\mu\text{s}$ |
| Primary Undervoltage Lockout Threshold                     | $V_{\text{PRI\_UVLO-R}}$        | Applies only to reversilbe products in forward and in reverse direction; $I_{\text{PRI\_DC}} \leq 20$ while $V_{\text{PRI\_UVLO-R}} < V_{\text{PRI\_DC}} < V_{\text{PRI\_MIN}}$ | <b>26</b>   | 28   | <b>30</b>   | V             |
| Primary Undervoltage Recovery Threshold                    | $V_{\text{PRI\_UVLO+R}}$        | Applies only to reversilbe products in forward and in reverse direction;  | <b>28</b>   | 30   | <b>32</b>   | V             |
| Primary Undervoltage Lockout Hysteresis                    | $V_{\text{PRI\_UVLO\_HYST\_R}}$ | Applies only to reversilbe products in forward and in reverse direction;  |             | 2    |             | V             |
| Primary Output Overcurrent Trip Threshold (Analog)         | $I_{\text{PRI\_OUT\_OCP}}$      | Module latched shutdown with $V_{\text{PRI\_DC}} < V_{\text{PRI\_UVLO-R}}$  | <b>28.3</b> | 35   | <b>40</b>   | A             |
| Primary Output Overcurrent Response Time Constant (Analog) | $t_{\text{PRI\_OUT\_OCP}}$      | Effective internal RC filter  |             | 3    |             | ms            |
| Primary Short Circuit Protection Trip Threshold            | $I_{\text{PRI\_SCP}}$           | Module latched shutdown with $V_{\text{PRI\_DC}} < V_{\text{PRI\_UVLO-R}}$  | <b>37.5</b> |      |             | A             |
| Primary Short Circuit Protection Response Time             | $t_{\text{PRI\_SCP}}$           |   |             | 1    |             | $\mu\text{s}$ |
| Primary Output Overcurrent Trip Threshold (PMBus)          | $I_{\text{PRI\_OUT\_OCP}}$      | Module latched shutdown with $V_{\text{PRI\_DC}} < V_{\text{PRI\_UVLO-R}}$  | <b>32</b>   | 34   | <b>36</b>   | A             |
| Primary Output Overcurrent Response Time Constant (PMBus)  | $t_{\text{PRI\_OUT\_OCP}}$      | Module latched shutdown with $V_{\text{PRI\_DC}} < V_{\text{PRI\_UVLO-R}}$  |             | 3    |             | ms            |

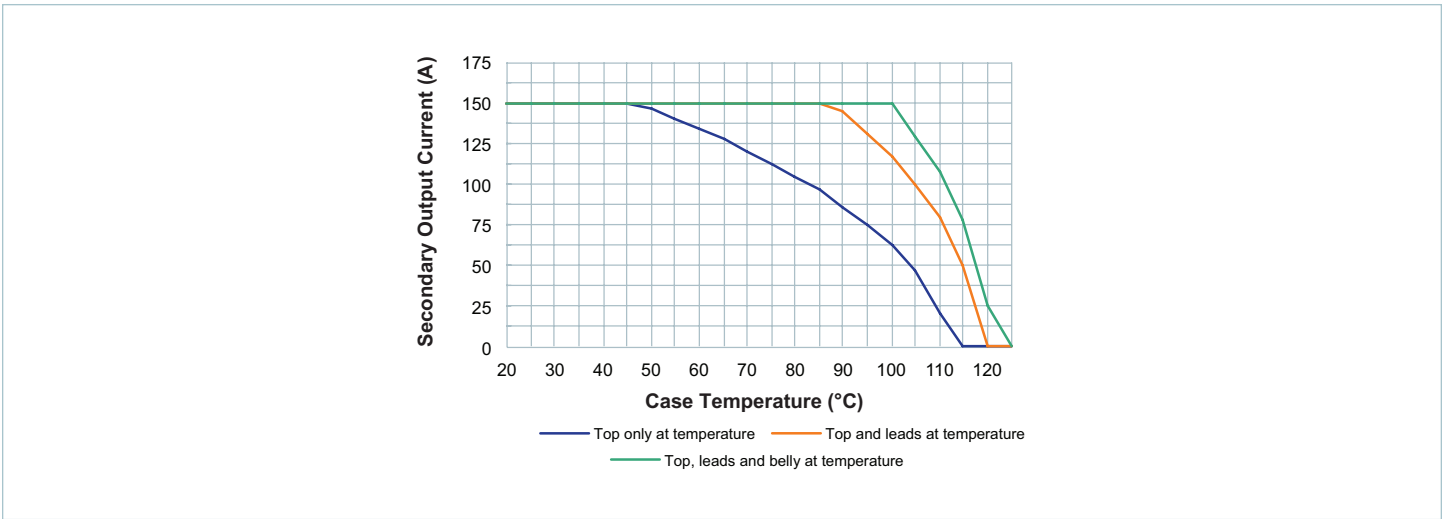

Figure 1 — Specified thermal operating area

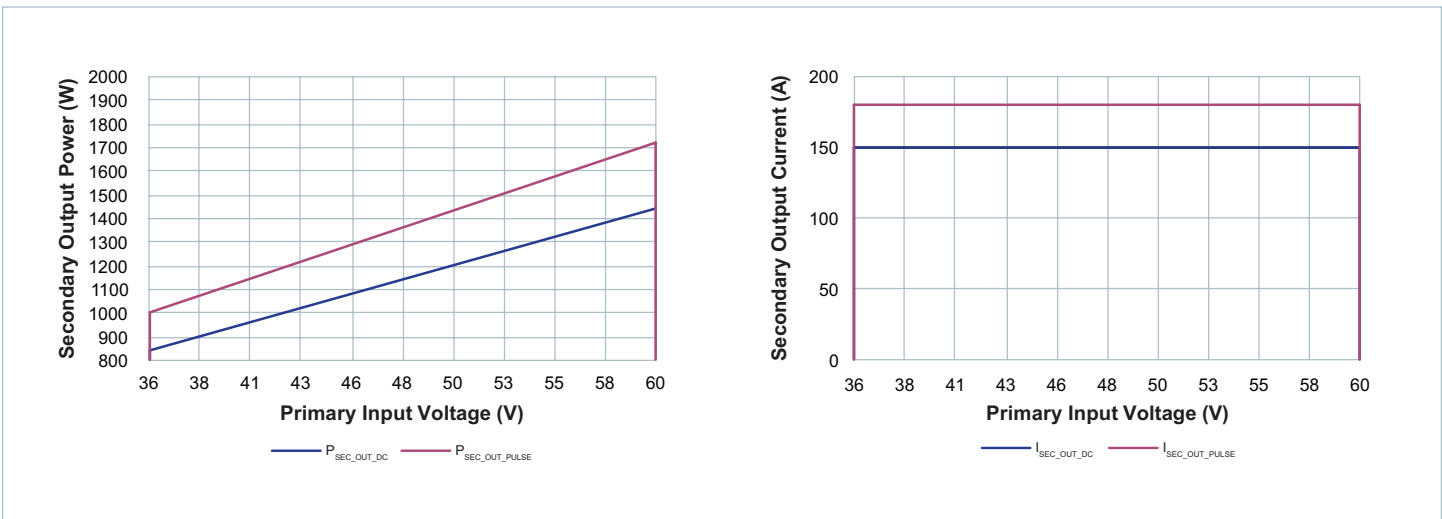

Figure 2 — Specified electrical operating area using rated  $R_{SEC\_HOT}$

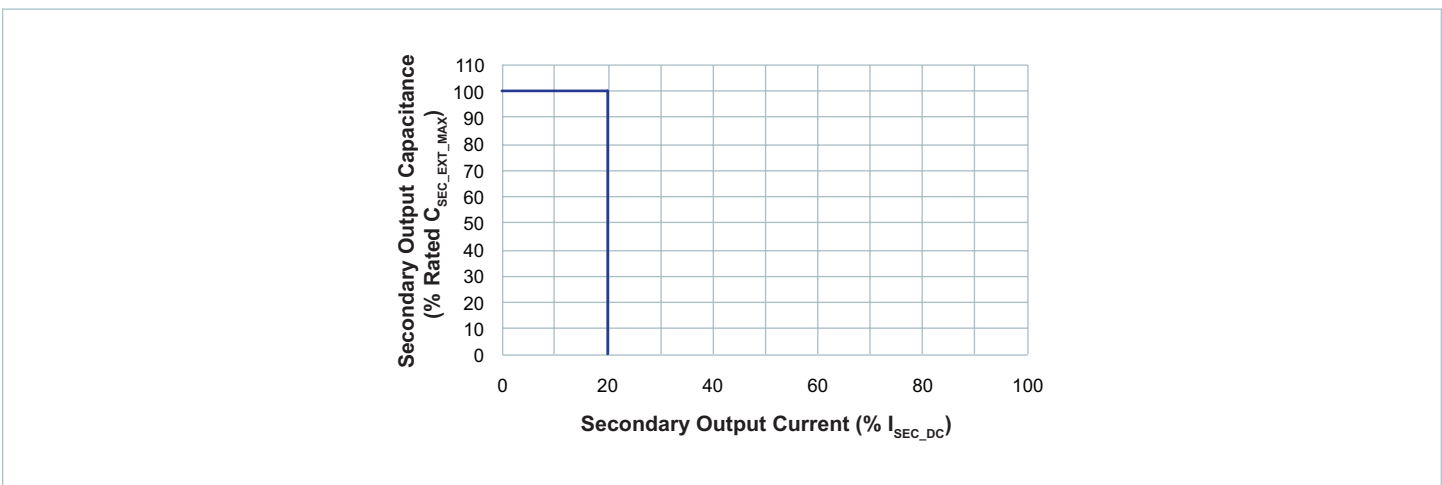

Figure 3 — Specified Primary start-up into load current and external capacitance

Analog Control Signal Characteristics

Specifications apply over all line, load conditions, unless otherwise noted; **Boldface** specifications apply over the temperature range of  $-40^{\circ}\text{C} \leq T_{\text{INTERNAL}} \leq 125^{\circ}\text{C}$  (T-Grade); All other specifications are at  $T_{\text{INTERNAL}} = 25^{\circ}\text{C}$  unless otherwise noted.

| Temperature Monitor   |                   |   |                          |   |              |            |              |               |                                |
|---|-------------------|---|--------------------------|---|--------------|------------|--------------|---------------|--------------------------------|
| <ul style="list-style-type: none"> <li>The TM pin is a standard analog I/O configured as an output from an internal <math>\mu\text{C}</math>.</li> <li>The TM pin monitors the internal temperature of the controller IC within an accuracy of <math>\pm 5^{\circ}\text{C}</math>.</li> <li><math>\mu\text{C}</math> 250kHz PWM output internally pulled high to 3.3V.</li> </ul> |                   |   |                          |   |              |            |              |               |                                |
| SIGNAL TYPE   | STATE             | ATTRIBUTE                               | SYMBOL                   | CONDITIONS / NOTES  | MIN          | TYP        | MAX          | UNIT          |                                |
| DIGITAL OUTPUT  | Startup           | Powertrain active to TM time            | $t_{\text{TM}}$          |   |              | <b>100</b> |              | $\mu\text{s}$ |                                |
|   |                   | TM Duty Cycle                           | $\text{TM}_{\text{PWM}}$ |   | <b>18.18</b> |            | <b>68.18</b> | %             |                                |
|   | Regular Operation | TM Current                              | $I_{\text{TM}}$          |   |              |            |              | <b>4</b>      | mA                             |
|   |                   | Recommended External filtering          |                          |   |              |            |              |               |                                |
|   |                   | TM Capacitance (External)               | $C_{\text{TM\_EXT}}$     | Recommended External filtering  |              |            | 0.01         |               | $\mu\text{F}$                  |
|   |                   | TM Resistance (External)                | $R_{\text{TM\_EXT}}$     | Recommended External filtering  |              |            | 1            |               | $\text{k}\Omega$               |
|   |                   | Specifications using recommended filter |                          |   |              |            |              |               |                                |
|   |                   | TM Gain                                 | $A_{\text{TM}}$          |   |              |            | 10           |               | $\text{mV} / ^{\circ}\text{C}$ |
|   |                   | TM Voltage Reference                    | $V_{\text{TM\_AMB}}$     |   |              |            | 1.27         |               | V                              |
|   |                   | TM Voltage Ripple                       | $V_{\text{TM\_PP}}$      | $R_{\text{TM\_EXT}} = 1\text{K Ohm}, C_{\text{TM\_EXT}} = 0.01\mu\text{F}, V_{\text{PRI\_DC}} = 54\text{V}, I_{\text{SEC\_DC}} = 150\text{A}$<br>$T_{\text{INTERNAL}} \leq 100^{\circ}\text{C}$ |              |            | 28           |               | mV                             |
|   |                   |   |                          |   |              | 40         |              |               |                                |

| Enable / Disable Control   |                   |                              |                              |   |            |            |     |                  |
|--|-------------------|------------------------------|------------------------------|---|------------|------------|-----|------------------|
| <ul style="list-style-type: none"> <li>The EN pin is a standard analog I/O configured as an input to an internal <math>\mu\text{C}</math>.</li> <li>It is internally pulled high to 3.3V.</li> <li>When held low the BCM internal bias will be disabled and the powertrain will be inactive.</li> <li>In an array of BCMS, EN pins should be interconnected to synchronize startup.</li> </ul> |                   |                              |                              |   |            |            |     |                  |
| SIGNAL TYPE  | STATE             | ATTRIBUTE                    | SYMBOL                       | CONDITIONS / NOTES  | MIN        | TYP        | MAX | UNIT             |
| ANALOG INPUT   | Startup           | EN to Powertrain active time | $t_{\text{EN\_START}}$       | $V_{\text{PRI\_DC}} > V_{\text{PRI\_UVLO+}}$ , EN held low both conditions satisfied for $T > t_{\text{PRI\_UVLO+\_DELAY}}$ |            | <b>250</b> |     | $\mu\text{s}$    |
|  | Regular Operation | EN Voltage Threshold         | $V_{\text{EN\_TH}}$          |   | <b>2.3</b> |            |     | V                |
|  |                   | EN Resistance (Internal)     | $R_{\text{EN\_INT}}$         | Internal pull up resistor   |            | 1.5        |     | $\text{k}\Omega$ |
|  |                   | EN Disable Threshold         | $V_{\text{EN\_DISABLE\_TH}}$ |   |            |            | 1   | V                |

Analog Control Signal Characteristics (Cont.)

Specifications apply over all line, load conditions, unless otherwise noted; **Boldface** specifications apply over the temperature range of  $-40^{\circ}\text{C} \leq T_{\text{INTERNAL}} \leq 125^{\circ}\text{C}$  (T-Grade); All other specifications are at  $T_{\text{INTERNAL}} = 25^{\circ}\text{C}$  unless otherwise noted.

| Auxiliary Voltage Source  |                            |                                |  |  |            |          |            |               |               |
|---|----------------------------|--------------------------------|--|--|------------|----------|------------|---------------|---------------|
| <ul style="list-style-type: none"> <li>The VAUX pin is a standard analog I/O configured as an output from an internal <math>\mu\text{C}</math>.</li> <li>VAUX is internally connected to <math>\mu\text{C}</math> output as internally pulled high to a 3.3V regulator with 2% tolerance, a 1% resistor of 1.5k<math>\Omega</math>.</li> <li>VAUX can be used as a "Ready to process full power" flag. This pin transitions VAUX voltage after a 2 ms delay from the start of powertrain activating, signaling the end of softstart.</li> <li>VAUX can be used as "Fault flag". This pin is pulled low internally when a fault protection is detected.</li> </ul> |                            |                                |  |  |            |          |            |               |               |
| SIGNAL TYPE   | STATE                      | ATTRIBUTE                      | SYMBOL   | CONDITIONS / NOTES   | MIN        | TYP      | MAX        | UNIT          |               |
| ANALOG OUTPUT   | Startup                    | Powertrain active to VAUX time | $t_{\text{VAUX}}$                              | Powertrain active to VAUX High   |            | <b>2</b> |            | ms            |               |
|   | Regular Operation          | VAUX Voltage                   | $V_{\text{VAUX}}$                              |  | <b>2.8</b> |          | <b>3.3</b> | V             |               |
|   |                            | VAUX Available Current         | $I_{\text{VAUX}}$                              |  |            |          | <b>4</b>   | mA            |               |
|   |                            | VAUX Voltage Ripple            | $V_{\text{VAUX\_PP}}$                          | $T_{\text{INTERNAL}} \leq 100^{\circ}\text{C}$                                 |            | 50       |            | <b>100</b>    | mV            |
|   |                            |                                |  |  |            |          |            |               |               |
|   |                            | VAUX Capacitance (External)    | $C_{\text{VAUX\_EXT}}$                         |  |            |          |            | 0.01          | $\mu\text{F}$ |
|   | VAUX Resistance (External) | $R_{\text{VAUX\_EXT}}$         | $V_{\text{PRI\_DC}} < V_{\mu\text{C\_ACTIVE}}$ |  | 1.5        |          |            | k $\Omega$    |               |
| Fault   | VAUX Fault Response Time   | $t_{\text{VAUX\_FR}}$          |  | From fault to $V_{\text{VAUX}} = 2.8\text{V}$ , $C_{\text{VAUX}} = 0\text{pF}$ |            | 10       |            | $\mu\text{s}$ |               |

**PMBus Control Signal Characteristics**

Specifications apply over all line, load conditions, unless otherwise noted; **Boldface** specifications apply over the temperature range of  $-40^{\circ}\text{C} \leq T_{\text{INTERNAL}} \leq 125^{\circ}\text{C}$  (T-Grade); All other specifications are at  $T_{\text{INTERNAL}} = 25^{\circ}\text{C}$  unless otherwise noted.

| UART SER-IN / SER-OUT Pins  |                   |                              |                           |                              |     |            |            |        |    |
|---|-------------------|------------------------------|---------------------------|------------------------------|-----|------------|------------|--------|----|
| <ul style="list-style-type: none"> <li>• Universal Asynchronous Receiver/Transmitter (UART) pins.</li> <li>• The BCM communication version is not intended to be used without a Digital Supervisor.</li> <li>• Isolated I<sup>2</sup>C communication and telemetry is available when using Vicor Digital Isolator and Vicor Digital Supervisor. Please see specific product data sheet for more details.</li> <li>• UART SER-IN pin is internally pulled high using a 1.5kΩ to 3.3V.</li> </ul> |                   |                              |                           |                              |     |            |            |        |    |
| SIGNAL TYPE   | STATE             | ATTRIBUTE                    | SYMBOL                    | CONDITIONS / NOTES           | MIN | TYP        | MAX        | UNIT   |    |
| GENERAL I/O   | Regular Operation | Baud Rate                    | BR <sub>UART</sub>        | Rate                         |     | <b>750</b> |            | Kbit/s |    |
|   |                   | <b>SER-IN Pin</b>            |                           |                              |     |            |            |        |    |
| DIGITAL INPUT   | Regular Operation | SER-IN Input Voltage Range   | V <sub>SER-IN_IH</sub>    |                              | 2.3 |            |            | V      |    |
|   |                   |                              | V <sub>SER-IN_IL</sub>    |                              |     |            | 1          | V      |    |
|   |                   | SER-IN rise time             | t <sub>SER-IN_RISE</sub>  | 10% to 90%                   |     | 400        |            |        | ns |
|   |                   | SER-IN fall time             | t <sub>SER-IN_FALL</sub>  | 10% to 90%                   |     | 25         |            |        | ns |
|   |                   | SER-IN R <sub>PULLUP</sub>   | R <sub>SER-IN_PLP</sub>   | Pull up to 3.3V              |     | 1.5        |            |        | kΩ |
|   |                   | SER-IN External Capacitance  | C <sub>SER-IN_EXT</sub>   |                              |     |            |            | 400    | pF |
| DIGITAL OUTPUT  | Regular Operation | <b>SER-OUT Pin</b>           |                           |                              |     |            |            |        |    |
|   |                   | SER-OUT Output Voltage Range | V <sub>SER-OUT_OH</sub>   | 0mA ≥ I <sub>OH</sub> ≥ -4mA | 2.8 |            |            |        | V  |
|   |                   |                              | V <sub>SER-OUT_OL</sub>   | 0mA ≤ I <sub>OL</sub> ≤ 4mA  |     |            |            | 0.5    | V  |
|   |                   | SER-OUT rise time            | t <sub>SER-OUT_RISE</sub> | 10% to 90%                   |     | 55         |            |        | ns |
|   |                   | SER-OUT fall time            | t <sub>SER-OUT_FALL</sub> | 10% to 90%                   |     | 45         |            |        | ns |
|   |                   | SER-OUT source current       | I <sub>SER-OUT</sub>      | V <sub>SER-OUT</sub> = 2.8V  |     |            |            | 6      | mA |
|   |                   | SER-OUT output impedance     | Z <sub>SER-OUT</sub>      |                              |     |            | <b>120</b> |        | Ω  |

| Enable / Disable Control  |                   |                              |                            |  |            |            |     |      |    |
|---|-------------------|------------------------------|----------------------------|--|------------|------------|-----|------|----|
| <ul style="list-style-type: none"> <li>• The EN pin is a standard analog I/O configured as an input to an internal μC.</li> <li>• It is internally pulled high to 3.3V.</li> <li>• When held low the BCM internal bias will be disabled and the powertrain will be inactive.</li> <li>• In an array of BCMs, EN pins should be interconnected to synchronize startup.</li> <li>• Enable / disable command will have no effect if the EN pin is disabled.</li> </ul> |                   |                              |                            |  |            |            |     |      |    |
| SIGNAL TYPE   | STATE             | ATTRIBUTE                    | SYMBOL                     | CONDITIONS / NOTES   | MIN        | TYP        | MAX | UNIT |    |
| ANALOG INPUT  | Startup           | EN to Powertrain active time | t <sub>EN_START</sub>      | V <sub>PRL_DC</sub> > V <sub>PRL_UVLO+</sub> ,<br>EN held low both conditions satisfied for t > t <sub>PRL_UVLO+_DELAY</sub> |            | <b>250</b> |     | μs   |    |
|   | Regular Operation | EN Voltage Threshold         | V <sub>ENABLE</sub>        |  | <b>2.3</b> |            |     | V    |    |
|   |                   | EN Resistance (Internal)     | R <sub>EN_INT</sub>        | Internal pull up resistor  |            |            | 1.5 |      | kΩ |
|   |                   | EN Disable Threshold         | V <sub>EN_DISABLE_TH</sub> |  |            |            |     | 1    | V  |

**PMBus Reported Characteristics**

Specifications apply over all line, load conditions, unless otherwise noted; **Boldface** specifications apply over the temperature range of  $-40^{\circ}\text{C} \leq T_{\text{INTERNAL}} \leq 125^{\circ}\text{C}$  (T-Grade); All other specifications are at  $T_{\text{INTERNAL}} = 25^{\circ}\text{C}$  unless otherwise noted.

| Monitored Telemetry  |  |  |  |                   |  |
|--|--|--|--|-------------------|--|
| ATTRIBUTE  | DIGITAL SUPERVISOR PMBUS™ READ COMMAND | ACCURACY (RATED RANGE)   | FUNCTIONAL REPORTING RANGE                       | UPDATE RATE       | REPORTED UNITS   |
| • The BCM communication version is not intended to be used without a Digital Supervisor. |  |  |  |                   |  |
| Input voltage  | (88h) READ_VIN                         | $\pm 5\%$ (LL - HL)  | 28V to 66V                                       | 100 $\mu\text{s}$ | $V_{\text{ACTUAL}} = V_{\text{REPORTED}} \times 10^{-1}$ |
| Input current  | (89h) READ_IIN                         | $\pm 20\%$ (10 - 20% of FL)<br>$\pm 5\%$ (20 - 133% of FL)                 | -34A to 34A                                      | 100 $\mu\text{s}$ | $I_{\text{ACTUAL}} = I_{\text{REPORTED}} \times 10^{-2}$ |
| Output voltage <sup>[1]</sup>  | (8Bh) READ_VOUT                        | $\pm 5\%$ (LL - HL)  | 4.7V to 11V                                      | 100 $\mu\text{s}$ | $V_{\text{ACTUAL}} = V_{\text{REPORTED}} \times 10^{-1}$ |
| Output current   | (8Ch) READ_IOUT                        | $\pm 20\%$ (10 - 20% of FL)<br>$\pm 5\%$ (20 - 133% of FL)                 | -204A to 204A                                    | 100 $\mu\text{s}$ | $I_{\text{ACTUAL}} = I_{\text{REPORTED}} \times 10^{-2}$ |
| Output resistance  | (D4h) READ_ROUT                        | $\pm 5\%$ (50 - 100% of FL) at NL<br>$\pm 10\%$ (50 - 100% of FL)(LL - HL) | 500 $\mu$ to 3000 $\mu$                          | 100ms             | $R_{\text{ACTUAL}} = R_{\text{REPORTED}} \times 10^{-5}$ |
| Temperature <sup>[2]</sup>   | (8Dh) READ_TEMPERATURE_1               | $\pm 7^{\circ}\text{C}$ (Full Range)                                       | -55 $^{\circ}\text{C}$ to 130 $^{\circ}\text{C}$ | 100ms             | $T_{\text{ACTUAL}} = T_{\text{REPORTED}}$                |

<sup>[1]</sup> Default READ Output Voltage returned when unit is disabled = -300 V.

<sup>[2]</sup> Default READ Temperature returned when unit is disabled = -273 $^{\circ}\text{C}$ .

| Variable Parameter   |  |   |  |                             |               |
|--|--|---|--|-----------------------------|---------------|
| ATTRIBUTE  | DIGITAL SUPERVISOR PMBUS™ COMMAND <sup>[3]</sup> | CONDITIONS / NOTES  | ACCURACY (RATED RANGE)                                     | FUNCTIONAL REPORTING RANGE  | DEFAULT VALUE |
| • Factory setting of all below Thresholds and Warning limits are 100% of listed protection values.   |  |   |  |                             |               |
| • Variables can be written only when module is disabled either EN pulled low or $V_{\text{IN}} < V_{\text{IN\_UVLO}}$ .                    |  |   |  |                             |               |
| • Module must remain in a disabled mode for 3 ms after any changes to the below variables allowing ample time to commit changes to EEPROM. |  |   |  |                             |               |
| Input / Output Overvoltage Protection Limit  | (55h) VIN_OV_FAULT_LIMIT                         | $V_{\text{IN\_OVLO}}$ is automatically 3% lower than this set point | $\pm 5\%$ (LL - HL)  | 28V to 66V                  | 100%          |
| Input / Output Overvoltage Warning Limit   | (57h) VIN_OV_WARN_LIMIT                          |   | $\pm 5\%$ (LL - HL)  | 28V to 66V                  | 100%          |
| Input / Output Undervoltage Protection Limit   | (D7h) DISABLE_FAULTS                             | Can only be disabled to a preset default value                      | $\pm 5\%$ (LL - HL)  | 28V or 66V                  | 100%          |
| Input Overcurrent Protection Limit   | (58h) IIN_OC_FAULT_LIMIT                         |   | $\pm 20\%$ (10 - 20% of FL)<br>$\pm 5\%$ (20 - 133% of FL) | 0 to 34A                    | 100%          |
| Input Overcurrent Warning Limit  | (5Dh) IIN_OC_WARN_LIMIT                          |   | $\pm 20\%$ (10 - 20% of FL)<br>$\pm 5\%$ (20 - 133% of FL) | 0 to 34A                    | 100%          |
| Overtemperature Protection Limit   | (4Fh) OT_FAULT_LIMIT                             |   | $\pm 7^{\circ}\text{C}$ (Full Range)                       | 0 to 125 $^{\circ}\text{C}$ | 100%          |
| Overtemperature Warning Limit  | (51h) OT_WARN_LIMIT                              |   | $\pm 7^{\circ}\text{C}$ ( Full Range)                      | 0 to 125 $^{\circ}\text{C}$ | 100%          |
| Turn on Delay  | (60h) TON_DELAY                                  | Additional time delay to the Undervoltage Startup Delay             | $\pm 50\mu\text{s}$  | 0 to 100ms                  | 0ms           |

<sup>[3]</sup> Refer to Digital Supervisor datasheet for complete list of supported commands.

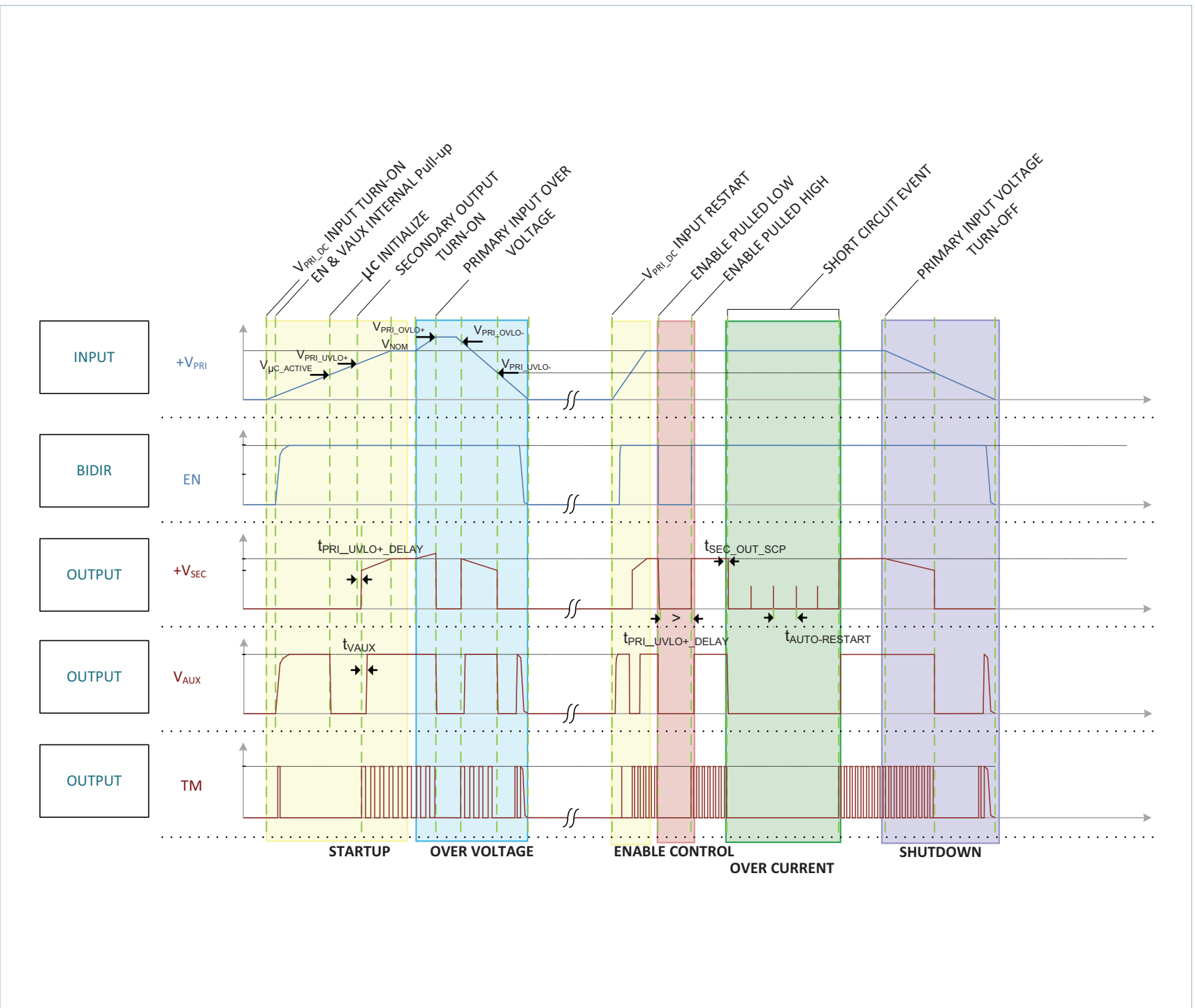



### High Level Functional State Diagram

Conditions that cause state transitions are shown along arrows. Sub-sequence activities listed inside the state bubbles.

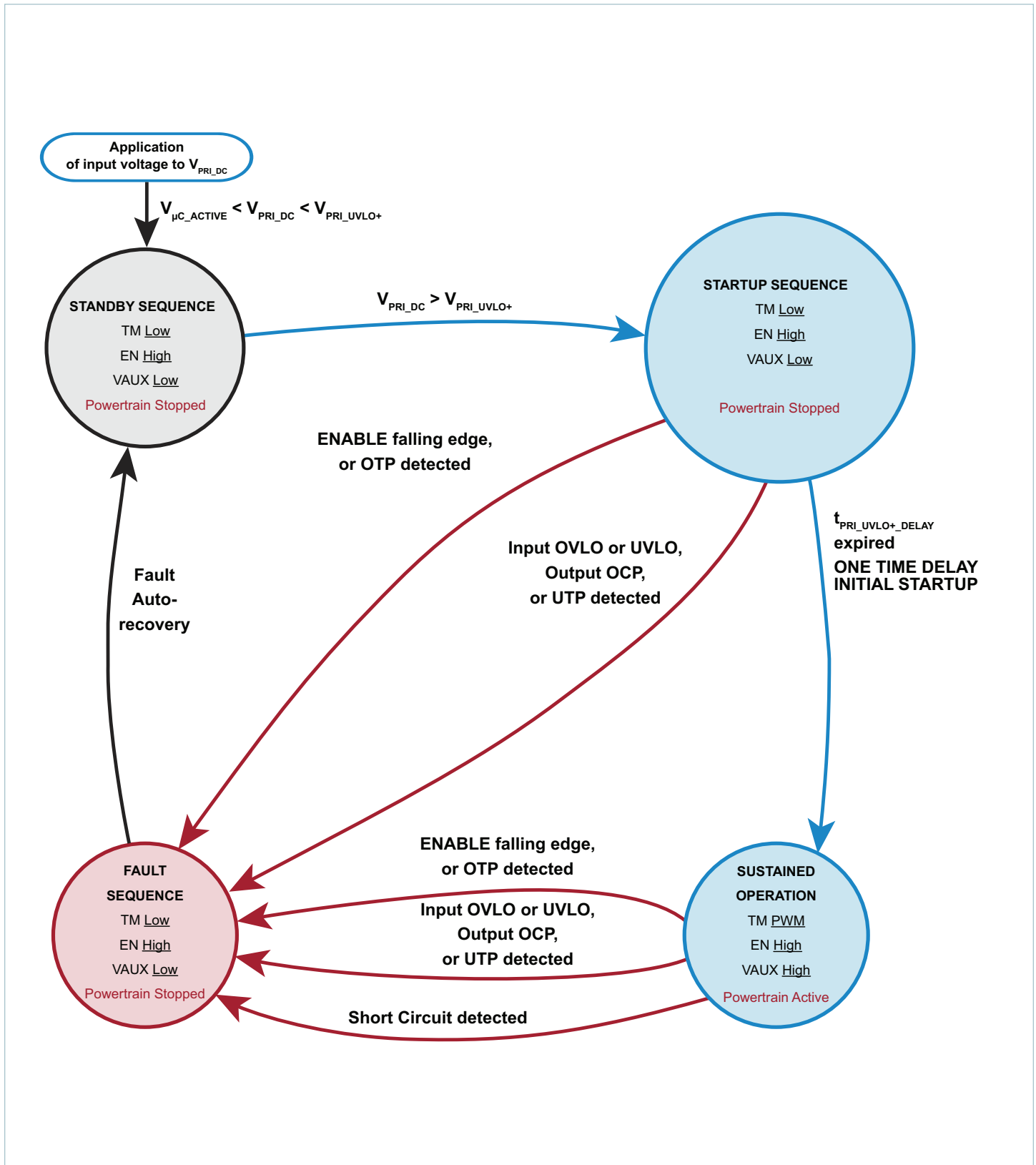

Application Characteristics

Product is mounted and temperature controlled via top side cold plate, unless otherwise noted. All data presented in this section are collected data from primary sourced units processing power in forward direction. See associated figures for general trend data.

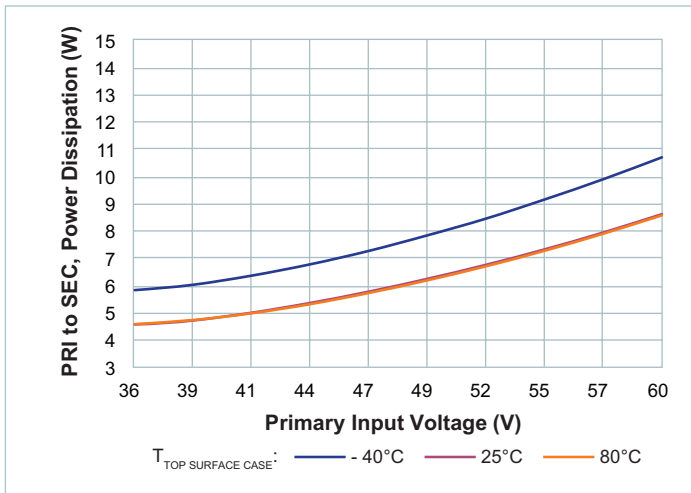

Figure 4 — No load power dissipation vs.  $V_{PRI\_DC}$

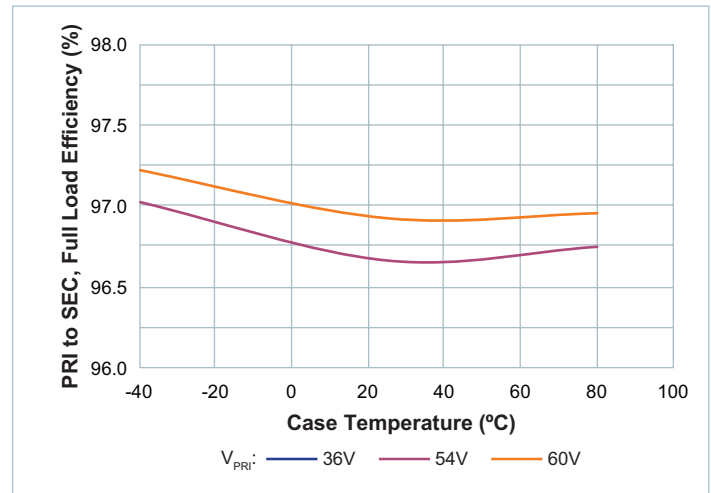

Figure 5 — Full load efficiency vs. temperature;  $V_{PRI\_DC}$

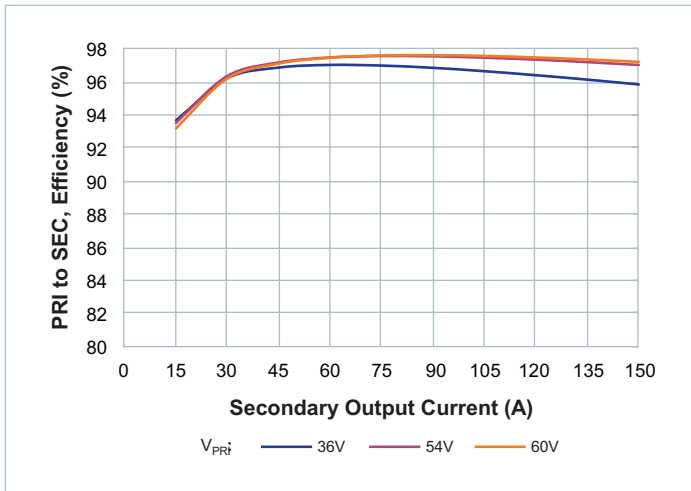

Figure 6 — Efficiency at  $T_{CASE} = -40^{\circ}C$

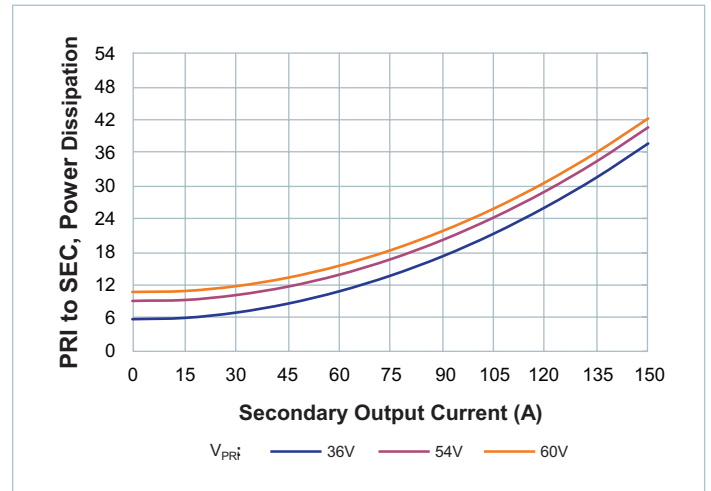

Figure 7 — Power dissipation at  $T_{CASE} = -40^{\circ}C$

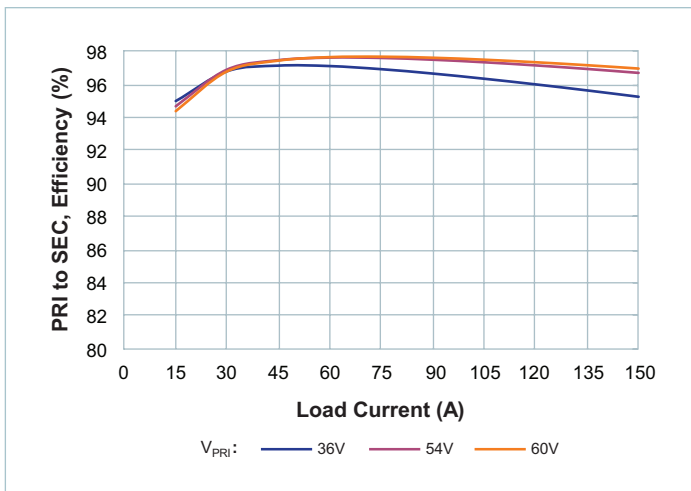

Figure 8 — Efficiency at  $T_{CASE} = 25^{\circ}C$

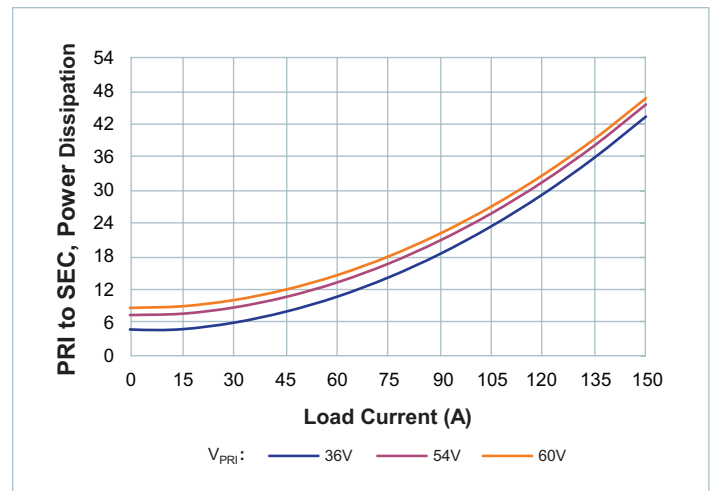

Figure 9 — Power dissipation at  $T_{CASE} = 25^{\circ}C$

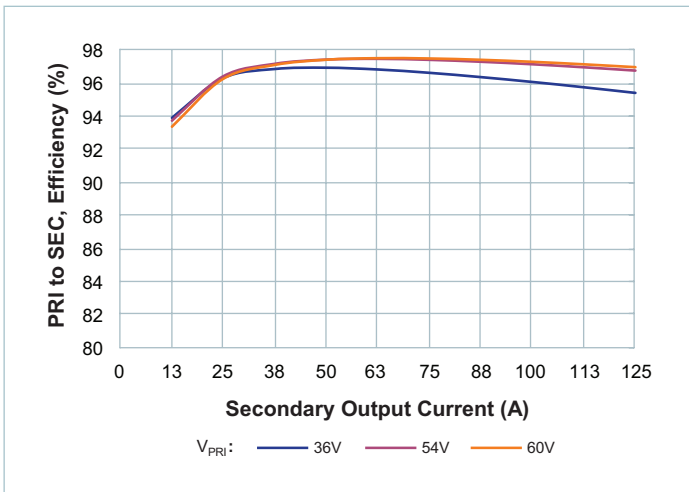

Figure 10 — Efficiency at  $T_{CASE} = 80^{\circ}C$

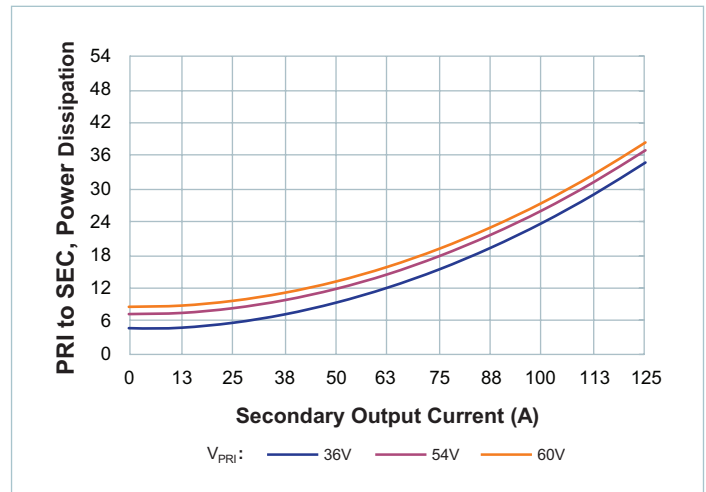

Figure 11 — Power dissipation at  $T_{CASE} = 80^{\circ}C$

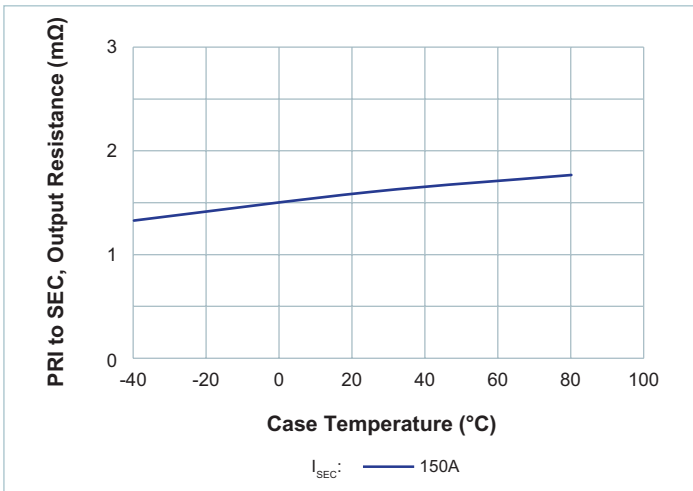

Figure 12 —  $R_{SEC}$  vs. temperature; Nominal  $V_{PRI\_DC}$   
 $I_{SEC\_DC} = 125A$  at  $T_{CASE} = 80^{\circ}C$

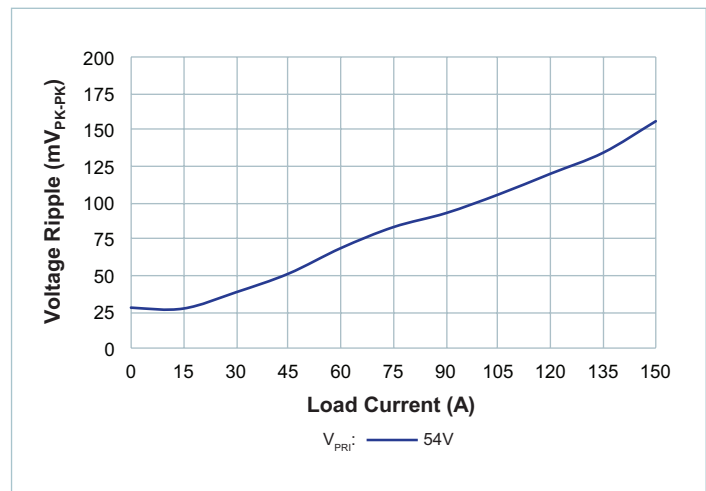
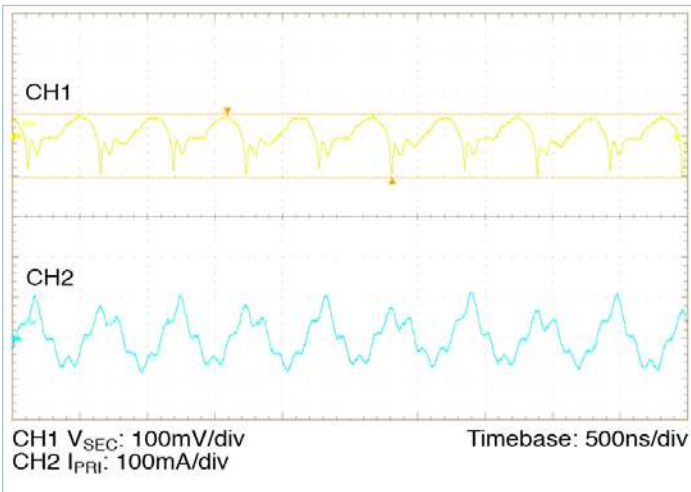
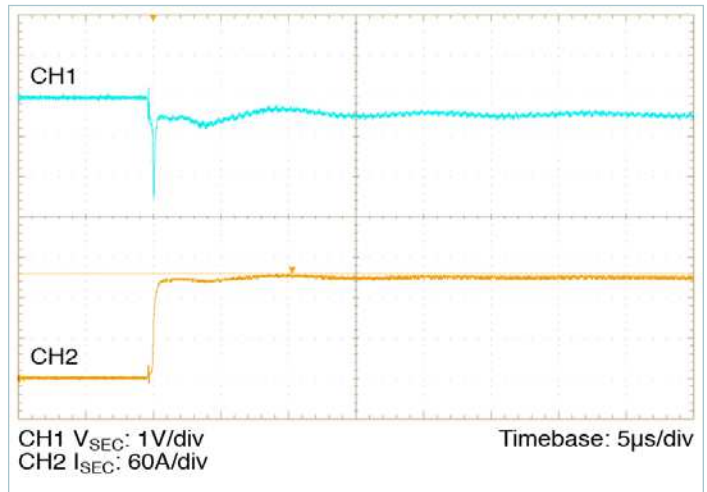

Figure 13 —  $V_{SEC\_OUT\_PP}$  vs.  $I_{SEC\_DC}$ ; No external  $C_{SEC\_OUT\_EXT}$ . Board mounted module, scope setting : 20MHz analog BW



**Figure 14** — Full load ripple, 2700 $\mu$ F  $C_{PRI\_IN\_EXT}$ ; No external  $C_{SEC\_OUT\_EXT}$ , Board mounted module, scope setting: 20MHz analog BW



**Figure 15** — 0A – 130A transient response:  $C_{PRI\_IN\_EXT} = 2700\mu F$ , no external  $C_{SEC\_OUT\_EXT}$

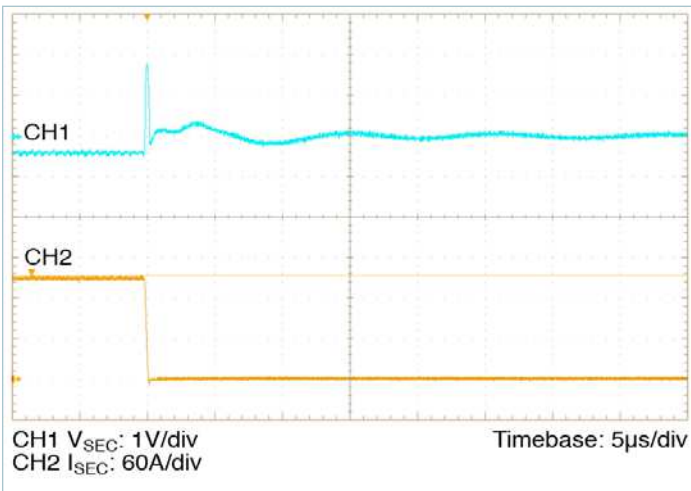

**Figure 16** — 130A – 0A transient response:  $C_{PRI\_IN\_EXT} = 2700\mu F$ , no external  $C_{SEC\_OUT\_EXT}$

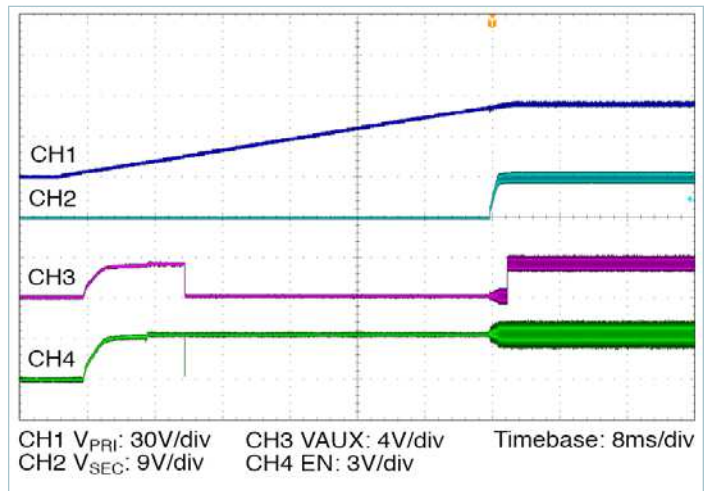

**Figure 17** — Start up from application of  $V_{PRI\_DC} = 54V$ , 20%  $I_{SEC\_DG}$ , 100%  $C_{SEC\_OUT\_EXT}$

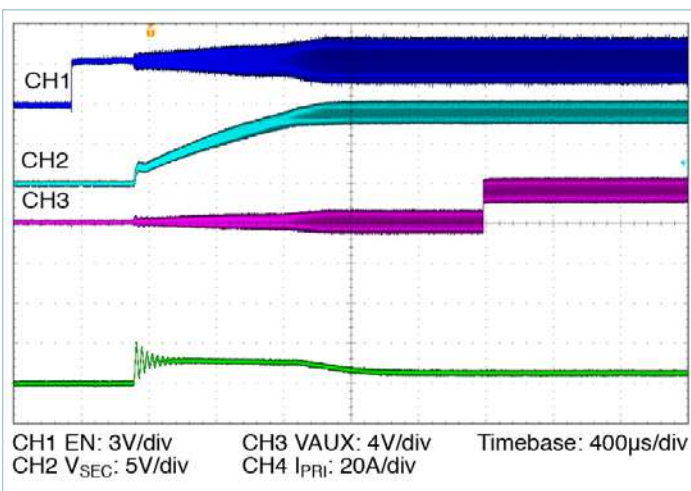

**Figure 18** — Start up from application of EN with pre-applied  $V_{PRI\_DC} = 54V$ , 20%  $I_{SEC\_DG}$ , 100%  $C_{SEC\_OUT\_EXT}$

General Characteristics

Specifications apply over all line, load conditions, unless otherwise noted; **Boldface** specifications apply over the temperature range of  $-40^{\circ}\text{C} \leq T_{\text{INTERNAL}} \leq 125^{\circ}\text{C}$  (T-Grade); All other specifications are at  $T_{\text{INTERNAL}} = 25^{\circ}\text{C}$  unless otherwise noted.

| Attribute                      | Symbol                | Conditions / Notes  | Min             | Typ             | Max             | Unit                                |
|--------------------------------|-----------------------|---|-----------------|-----------------|-----------------|-------------------------------------|
| <b>Mechanical</b>              |                       |   |                 |                 |                 |                                     |
| Length                         | L                     |   | 60.87 / [2.396] | 61.00 / [2.402] | 61.13 / [2.407] | mm/[in]                             |
| Width                          | W                     |   | 24.76 / [0.975] | 25.14 / [0.990] | 25.52 / [1.005] | mm/[in]                             |
| Height                         | H                     |   | 7.21 / [0.284]  | 7.26 / [0.286]  | 7.31 / [0.288]  | mm/[in]                             |
| Volume                         | Vol                   | Without Heatsink  |                 | 11.13 / [0.679] |                 | cm <sup>3</sup> /[in <sup>3</sup> ] |
| Weight                         | W                     |   |                 | 41 / [1.45]     |                 | g/[oz]                              |
| Lead finish                    |                       | Nickel  | 0.51            |                 | 2.03            | μm                                  |
|                                |                       | Palladium   | 0.02            |                 | 0.15            |                                     |
|                                |                       | Gold  | 0.003           |                 | 0.051           |                                     |
| <b>Thermal</b>                 |                       |   |                 |                 |                 |                                     |
| Operating Temperature          | T <sub>INTERNAL</sub> | BCM6123x60E10A5yzz (T-Grade)  | -40             |                 | 125             | °C                                  |
| Thermal Resistance Top Side    | INT-TOP               | Estimated thermal resistance to maximum temperature internal component from isothermal top    |                 | 1.39            |                 | °C/W                                |
| Thermal Resistance Leads       | INT-LEADS             | Estimated thermal resistance to maximum temperature internal component from isothermal leads  |                 | 1.27            |                 | °C/W                                |
| Thermal Resistance Bottom Side | INT-BOTTOM            | Estimated thermal resistance to maximum temperature internal component from isothermal bottom |                 | 1.40            |                 | °C/W                                |
| Thermal Capacity               |                       |   |                 | 34              |                 | Ws/°C                               |
| <b>Assembly</b>                |                       |   |                 |                 |                 |                                     |
| Storage temperature            |                       | BCM6123x60E10A5yzz (T-Grade)  | -55             |                 | 125             | °C                                  |
| ESD Withstand                  | ESD <sub>HBM</sub>    | Human Body Model, "ESDA / JEDEC JDS-001-2012" Class I-C (1kV to < 2kV)                        |                 |                 |                 |                                     |
|                                | ESD <sub>CDM</sub>    | Charge Device Model, "JESD 22-C 101-E" Class II (200V to < 500V)                              |                 |                 |                 |                                     |

## General Characteristics

Specifications apply over all line, load conditions, unless otherwise noted; **Boldface** specifications apply over the temperature range of  $-40^{\circ}\text{C} \leq T_{\text{INTERNAL}} \leq 125^{\circ}\text{C}$  (T-Grade); All other specifications are at  $T_{\text{INTERNAL}} = 25^{\circ}\text{C}$  unless otherwise noted.

| Soldering <sup>[1]</sup>            |                      |   |              |      |            |                 |
|-------------------------------------|----------------------|---|--------------|------|------------|-----------------|
| Peak Temperature Top Case           |                      |   |              |      | 135        | °C              |
| Safety                              |                      |   |              |      |            |                 |
| Isolation voltage / Dielectric test | V <sub>HIPO</sub> T  | PRIMARY to SECONDARY  | <b>2,250</b> |      |            | V <sub>DC</sub> |
|                                     |                      | PRIMARY to CASE   | <b>2,250</b> |      |            |                 |
|                                     |                      | SECONDARY to CASE   | <b>707</b>   |      |            |                 |
| Isolation Capacitance               | C <sub>PRI_SEC</sub> | Unpowered Unit  | <b>620</b>   | 780  | <b>940</b> | pF              |
| Insulation Resistance               | R <sub>PRI_SEC</sub> | At 500 Vdc  | <b>10</b>    |      |            | MΩ              |
| MTBF                                |                      | MIL-HDBK-217Plus Parts Count - 25°C<br>Ground Benign, Stationary, Indoors /<br>Computer |              | 4.45 |            | MHrs            |
|                                     |                      | Telcordia Issue 2 - Method I Case III; 25°C<br>Ground Benign, Controlled                |              | 7.01 |            | MHrs            |
| Agency Approvals / Standards        |                      | cTÜVus "EN 60950-1"   |              |      |            |                 |
|                                     |                      | cURus "UL 60950-1"  |              |      |            |                 |
|                                     |                      | CE Marked for Low Voltage Directive and RoHS Recast Directive, as applicable            |              |      |            |                 |

<sup>[1]</sup> Product is not intended for reflow solder attach.

PMBus™ System Diagram

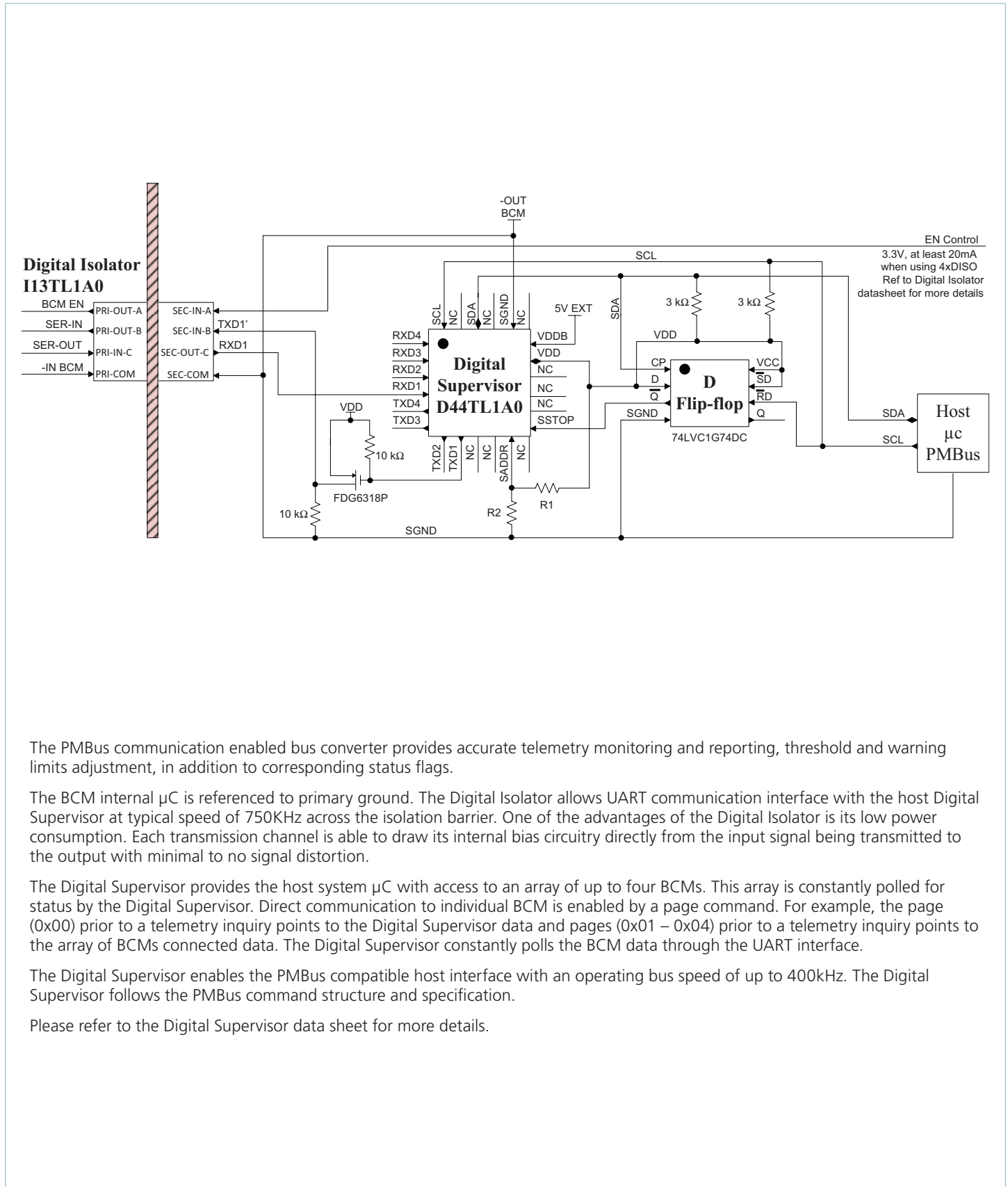

The PMBus communication enabled bus converter provides accurate telemetry monitoring and reporting, threshold and warning limits adjustment, in addition to corresponding status flags.

The BCM internal µC is referenced to primary ground. The Digital Isolator allows UART communication interface with the host Digital Supervisor at typical speed of 750KHz across the isolation barrier. One of the advantages of the Digital Isolator is its low power consumption. Each transmission channel is able to draw its internal bias circuitry directly from the input signal being transmitted to the output with minimal to no signal distortion.

The Digital Supervisor provides the host system µC with access to an array of up to four BCMS. This array is constantly polled for status by the Digital Supervisor. Direct communication to individual BCM is enabled by a page command. For example, the page (0x00) prior to a telemetry inquiry points to the Digital Supervisor data and pages (0x01 – 0x04) prior to a telemetry inquiry points to the array of BCMS connected data. The Digital Supervisor constantly polls the BCM data through the UART interface.

The Digital Supervisor enables the PMBus compatible host interface with an operating bus speed of up to 400kHz. The Digital Supervisor follows the PMBus command structure and specification.

Please refer to the Digital Supervisor data sheet for more details.

Sine Amplitude Converter™ Point of Load Conversion

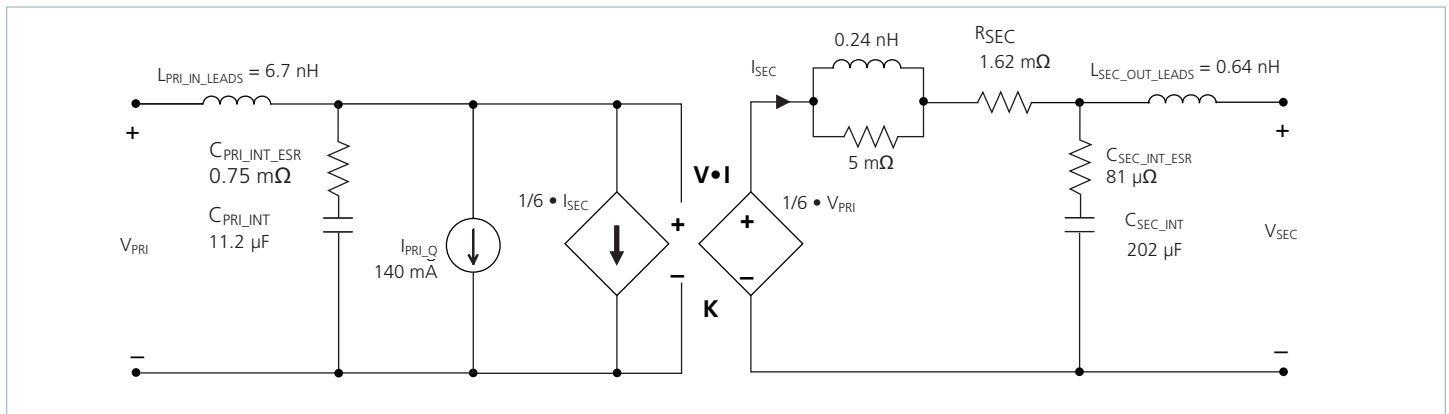

Figure 19 — BCM module AC model

The Sine Amplitude Converter (SAC™) uses a high frequency resonant tank to move energy from Primary to secondary and vice versa. The resonant LC tank, operated at high frequency, is amplitude modulated as a function of primary voltage and secondary current. A small amount of capacitance embedded in the primary and secondary stages of the module is sufficient for full functionality and is key to achieving high power density.

The BCM6123x60E10A5yzz SAC can be simplified into the preceding model.

At no load:

$$V_{SEC} = V_{PRI} \cdot K \tag{1}$$

K represents the “turns ratio” of the SAC. Rearranging Eq (1):

$$K = \frac{V_{SEC}}{V_{PRI}} \tag{2}$$

In the presence of load,  $V_{SEC}$  is represented by:

$$V_{SEC} = V_{PRI} \cdot K - I_{SEC} \cdot R_{SEC} \tag{3}$$

and  $I_{SEC}$  is represented by:

$$I_{SEC} = \frac{I_{PRI} - I_{PRI\_Q}}{K} \tag{4}$$

$R_{SEC}$  represents the impedance of the SAC, and is a function of the  $R_{DS(ON)}$  of the primary and secondary MOSFETs and the winding resistance of the power transformer.  $I_{PRI\_Q}$  represents the quiescent current of the SAC control, gate drive circuitry, and core losses.

The use of DC voltage transformation provides additional interesting attributes. Assuming that  $R_{SEC} = 0\Omega$  and  $I_{PRI\_Q} = 0A$ , Eq. (3) now becomes Eq. (1) and is essentially load independent, resistor R is now placed in series with  $V_{PRI}$ .

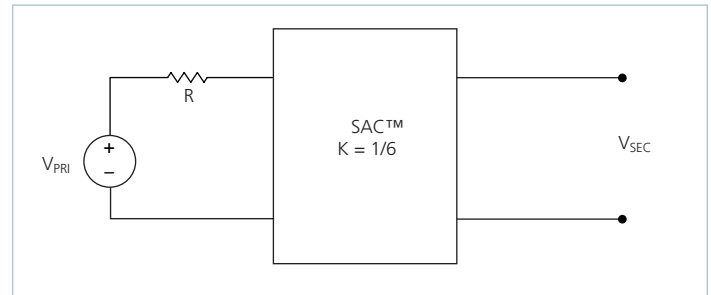

Figure 20 — K = 1/6 Sine Amplitude Converter with series primary resistor

The relationship between  $V_{PRI}$  and  $V_{SEC}$  becomes:

$$V_{SEC} = (V_{PRI} - I_{PRI} \cdot R) \cdot K \tag{5}$$

Substituting the simplified version of Eq. (4) ( $I_{PRI\_Q}$  is assumed = 0A) into Eq. (5) yields:

$$V_{SEC} = V_{PRI} \cdot K - I_{SEC} \cdot R \cdot K^2 \tag{6}$$



This is similar in form to Eq. (3), where  $R_{SEC}$  is used to represent the characteristic impedance of the SAC™. However, in this case a real R on the primary side of the SAC is effectively scaled by  $K^2$  with respect to the secondary.

Assuming that  $R = 1\Omega$ , the effective R as seen from the secondary side is  $28m\Omega$ , with  $K = 1/6$ .

A similar exercise should be performed with the addition of a capacitor or shunt impedance at the primary of the SAC. A switch in series with  $V_{PRI}$  is added to the circuit. This is depicted in Figure 21.

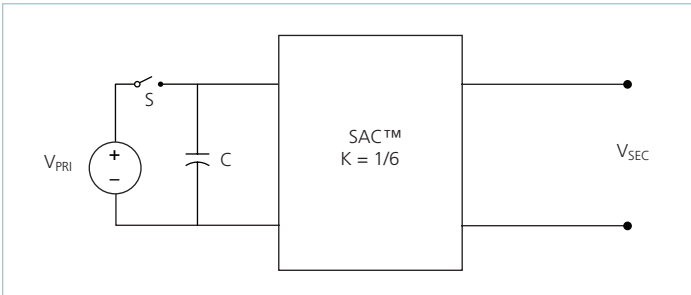

Figure 21 — Sine Amplitude Converter with primary capacitor

A change in  $V_{PRI}$  with the switch closed would result in a change in capacitor current according to the following equation:

$$I_C(t) = C \frac{dV_{PRI}}{dt} \quad (7)$$

Assume that with the capacitor charged to  $V_{PRI}$ , the switch is opened and the capacitor is discharged through the idealized SAC. In this case,

$$I_C = I_{SEC} \cdot K \quad (8)$$

substituting Eq. (1) and (8) into Eq. (7) reveals:

$$I_{SEC} = \frac{C}{K^2} \cdot \frac{dV_{SEC}}{dt} \quad (9)$$

The equation in terms of the secondary has yielded a  $K^2$  scaling factor for C, specified in the denominator of the equation.

A K factor less than unity results in an effectively larger capacitance on the secondary when expressed in terms of the primary. With a  $K = 1/6$  as shown in Figure 21,  $C = 1\mu F$  would appear as  $C = 36\mu F$  when viewed from the secondary.

Low impedance is a key requirement for powering a high-current, low-voltage load efficiently. A switching regulation stage should have minimal impedance while simultaneously providing appropriate filtering for any switched current. The use of a SAC between the regulation stage and the point of load provides a dual benefit of scaling down series impedance leading back to the source and scaling up shunt capacitance or energy storage as a function of its K factor squared. However, the benefits are not useful if the series impedance of the SAC is too high. The impedance of the SAC must be low, i.e. well beyond the crossover frequency of the system.

A solution for keeping the impedance of the SAC low involves switching at a high frequency. This enables small magnetic components because magnetizing currents remain low. Small magnetics mean small path lengths for turns. Use of low loss core material at high frequencies also reduces core losses.

The two main terms of power loss in the BCM module are:

- No load power dissipation ( $P_{PRI\_NL}$ ): defined as the power used to power up the module with an enabled powertrain at no load.
- Resistive loss ( $P_{R_{SEC}}$ ): refers to the power loss across the BCM module modeled as pure resistive impedance.

$$P_{DISSIPATED} = P_{PRI\_NL} + P_{R_{SEC}} \quad (10)$$

Therefore,

$$P_{SEC\_OUT} = P_{PRI\_IN} - P_{DISSIPATED} = P_{PRI\_IN} - P_{PRI\_NL} - P_{R_{SEC}} \quad (11)$$

The above relations can be combined to calculate the overall module efficiency:

$$\eta = \frac{P_{SEC\_OUT}}{P_{PRI\_IN}} = \frac{P_{PRI\_IN} - P_{PRI\_NL} - P_{R_{SEC}}}{P_{PRI\_IN}} \quad (12)$$

$$= \frac{V_{PRI} \cdot I_{PRI} - P_{PRI\_NL} - (I_{SEC})^2 \cdot R_{SEC}}{V_{PRI} \cdot I_{PRI}}$$

$$= 1 - \left( \frac{P_{PRI\_NL} + (I_{SEC})^2 \cdot R_{SEC}}{V_{PRI} \cdot I_{PRI}} \right)$$

## Input and Output Filter Design

A major advantage of SAC™ systems versus conventional PWM converters is that the transformer based SAC does not require external filtering to function properly. The resonant LC tank, operated at extreme high frequency, is amplitude modulated as a function of primary voltage and secondary current and efficiently transfers charge through the isolation transformer. A small amount of capacitance embedded in the primary and secondary stages of the module is sufficient for full functionality and is key to achieving power density.

This paradigm shift requires system design to carefully evaluate external filters in order to:

- Guarantee low source impedance:

To take full advantage of the BCM module’s dynamic response, the impedance presented to its primary terminals must be low from DC to approximately 5MHz. The connection of the bus converter module to its power source should be implemented with minimal distribution inductance. If the interconnect inductance exceeds 100nH, the primary should be bypassed with a RC damper to retain low source impedance and stable operation. With an interconnect inductance of 200nH, the RC damper may be as high as 1µF in series with 0.3Ω. A single electrolytic or equivalent low-Q capacitor may be used in place of the series RC bypass.

- Further reduce primary and/or secondary voltage ripple without sacrificing dynamic response:

Given the wide bandwidth of the module, the source response is generally the limiting factor in the overall system response. Anomalies in the response of the primary source will appear at the secondary of the module multiplied by its K factor.

- Protect the module from overvoltage transients imposed by the system that would exceed maximum ratings and induce stresses:

The module primary/secondary voltage ranges shall not be exceeded. An internal overvoltage lockout function prevents operation outside of the normal operating primary range. Even when disabled, the powertrain is exposed to the applied voltage and power MOSFETs must withstand it.

Total load capacitance at the secondary of the BCM module shall not exceed the specified maximum. Owing to the wide bandwidth and low secondary impedance of the module, low-frequency bypass capacitance and significant energy storage may be more densely and efficiently provided by adding capacitance at the primary of the module. At frequencies <500kHz the module appears as an impedance of R<sub>SEC</sub> between the source and load.

Within this frequency range, capacitance at the primary appears as effective capacitance on the secondary per the relationship defined in Eq. (13).

$$C_{SEC\_EXT} = \frac{C_{PRI\_EXT}}{K^2} \quad (13)$$

This enables a reduction in the size and number of capacitors used in a typical system.

## Thermal Considerations

The ChiP package provides a high degree of flexibility in that it presents three pathways to remove heat from internal power dissipating components. Heat may be removed from the top surface, the bottom surface and the leads. The extent to which these three surfaces are cooled is a key component for determining the maximum current that is available from a ChiP, as can be seen from Figure 1.

Since the ChiP has a maximum internal temperature rating, it is necessary to estimate this internal temperature based on a real thermal solution. Given that there are three pathways to remove heat from the ChiP, it is helpful to simplify the thermal solution into a roughly equivalent circuit where power dissipation is modeled as a current source, isothermal surface temperatures are represented as voltage sources and the thermal resistances are represented as resistors. Figure 22 shows the “thermal circuit” for a VI Chip® BCM module 6123 in an application where the top, bottom, and leads are cooled. In this case, the BCM power dissipation is PD<sub>TOTAL</sub> and the three surface temperatures are represented as T<sub>CASE\_TOP</sub>, T<sub>CASE\_BOTTOM</sub>, and T<sub>LEADS</sub>. This thermal system can now be very easily analyzed using a SPICE simulator with simple resistors, voltage sources, and a current source. The results of the simulation would provide an estimate of heat flow through the various pathways as well as internal temperature.

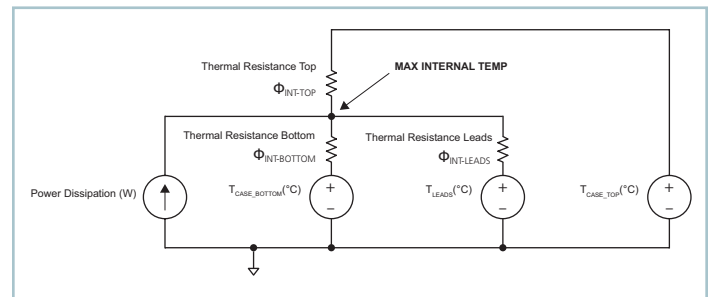

Figure 22 — Top case, bottom case and leads thermal model

Alternatively, equations can be written around this circuit and analyzed algebraically:

$$\begin{aligned} T_{INT} - PD_1 \cdot \Phi_{INT-TOP} &= T_{CASE\_TOP} \\ T_{INT} - PD_2 \cdot \Phi_{INT-BOTTOM} &= T_{CASE\_BOTTOM} \\ T_{INT} - PD_3 \cdot \Phi_{INT-LEADS} &= T_{LEADS} \\ PD_{TOTAL} &= PD_1 + PD_2 + PD_3 \end{aligned}$$

Where T<sub>INT</sub> represents the internal temperature and PD<sub>1</sub>, PD<sub>2</sub>, and PD<sub>3</sub> represent the heat flow through the top side, bottom side, and leads respectively.

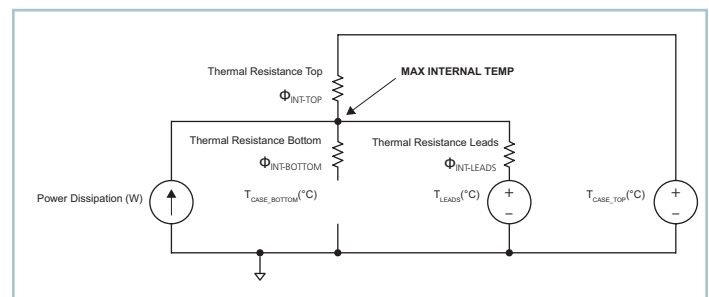

Figure 23 — Top case and leads thermal model