



Chipsmall Limited consists of a professional team with an average of over 10 year of expertise in the distribution of electronic components. Based in Hongkong, we have already established firm and mutual-benefit business relationships with customers from,Europe,America and south Asia,supplying obsolete and hard-to-find components to meet their specific needs.

With the principle of "Quality Parts,Customers Priority,Honest Operation,and Considerate Service",our business mainly focus on the distribution of electronic components. Line cards we deal with include Microchip,ALPS,ROHM,Xilinx,Pulse,ON,Everlight and Freescale. Main products comprise IC,Modules,Potentiometer,IC Socket,Relay,Connector.Our parts cover such applications as commercial,industrial, and automotives areas.

We are looking forward to setting up business relationship with you and hope to provide you with the best service and solution. Let us make a better world for our industry!



## Contact us

Tel: +86-755-8981 8866 Fax: +86-755-8427 6832

Email & Skype: info@chipsmall.com Web: www.chipsmall.com

Address: A1208, Overseas Decoration Building, #122 Zhenhua RD., Futian, Shenzhen, China



## Important notice

Dear Customer,

On 7 February 2017 the former NXP Standard Product business became a new company with the tradename **Nexperia**. Nexperia is an industry leading supplier of Discrete, Logic and PowerMOS semiconductors with its focus on the automotive, industrial, computing, consumer and wearable application markets

In data sheets and application notes which still contain NXP or Philips Semiconductors references, use the references to Nexperia, as shown below.

Instead of <http://www.nxp.com>, <http://www.philips.com/> or <http://www.semiconductors.philips.com/>, use <http://www.nexperia.com>

Instead of [sales.addresses@www.nxp.com](mailto:sales.addresses@www.nxp.com) or [sales.addresses@www.semiconductors.philips.com](mailto:sales.addresses@www.semiconductors.philips.com), use [salesaddresses@nexperia.com](mailto:salesaddresses@nexperia.com) (email)

Replace the copyright notice at the bottom of each page or elsewhere in the document, depending on the version, as shown below:

- © NXP N.V. (year). All rights reserved or © Koninklijke Philips Electronics N.V. (year). All rights reserved

Should be replaced with:

- © **Nexperia B.V. (year). All rights reserved.**

If you have any questions related to the data sheet, please contact our nearest sales office via e-mail or telephone (details via [salesaddresses@nexperia.com](mailto:salesaddresses@nexperia.com)). Thank you for your cooperation and understanding,

Kind regards,

Team Nexperia

# BCP69; BC869; BC69PA

20 V, 2 A PNP medium power transistors

Rev. 7 — 12 October 2011

Product data sheet

## 1. Product profile

### 1.1 General description

PNP medium power transistor series in Surface-Mounted Device (SMD) plastic packages.

Table 1. Product overview

Type number <sup>[1]</sup>	Package			NPN complement
	NXP	JEITA	JEDEC	
BCP69	SOT223	SC-73	-	BCP68
BC869	SOT89	SC-62	TO-243	BC868
BC69PA	SOT1061	-	-	BC68PA

[1] Valid for all available selection groups.

### 1.2 Features and benefits

- High current
- Three current gain selections
- High power dissipation capability
- Exposed heatsink for excellent thermal and electrical conductivity (SOT89, SOT1061)
- Leadless very small SMD plastic package with medium power capability (SOT1061)
- AEC-Q101 qualified

### 1.3 Applications

- Linear voltage regulators
- High-side switches
- Battery-driven devices
- Power management
- MOSFET drivers
- Amplifiers

### 1.4 Quick reference data

Table 2. Quick reference data

Symbol	Parameter	Conditions	Min	Typ	Max	Unit
$V_{CEO}$	collector-emitter voltage	open base	-	-	-20	V
$I_C$	collector current		-	-	-2	A
$I_{CM}$	peak collector current	single pulse; $t_p \leq 1$ ms	-	-	-3	A



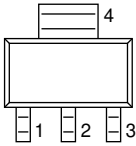
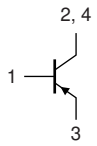
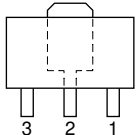
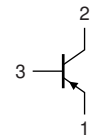
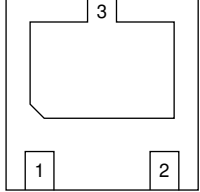
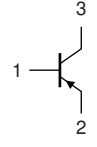
**Table 2. Quick reference data ...continued**

Symbol	Parameter	Conditions	Min	Typ	Max	Unit
$h_{FE}$	DC current gain	$V_{CE} = -1\text{ V};$ $I_C = -500\text{ mA}$	[1] 85	-	375	
	$h_{FE}$ selection -16	$V_{CE} = -1\text{ V};$ $I_C = -500\text{ mA}$	[1] 100	-	250	
	$h_{FE}$ selection -25	$V_{CE} = -1\text{ V};$ $I_C = -500\text{ mA}$	[1] 160	-	375	

[1] Pulse test:  $t_p \leq 300\ \mu\text{s}; \delta = 0.02$ .

## 2. Pinning information

**Table 3. Pinning**

Pin	Description	Simplified outline	Graphic symbol
<b>SOT223</b>			
1	base		 sym028
2	collector		
3	emitter		
4	collector		
<b>SOT89</b>			
1	emitter		 006aaa231
2	collector		
3	base		
<b>SOT1061</b>			
1	base	 Transparent top view	 sym013
2	emitter		
3	collector		

### 3. Ordering information

Table 4. Ordering information

Type number <sup>[1]</sup>	Package		
	Name	Description	Version
BCP69	SC-73	plastic surface-mounted package with increased heatsink; 4 leads	SOT223
BC869	SC-62	plastic surface-mounted package; exposed die pad for good heat transfer; 3 leads	SOT89
BC69PA	HUSON3	plastic thermal enhanced ultra thin small outline package; no leads; 3 terminals; body 2 × 2 × 0.65 mm	SOT1061

[1] Valid for all available selection groups.

### 4. Marking

Table 5. Marking codes

Type number	Marking code
BCP69	BCP69
BCP69-16	BCP69/16
BCP69-25	BCP69/25
BC869	CEC
BC869-16	CGC
BC869-25	CHC
BC69PA	B3
BC69-16PA	BM
BC69-25PA	BN



## 5. Limiting values

**Table 6. Limiting values**

*In accordance with the Absolute Maximum Rating System (IEC 60134).*

Symbol	Parameter	Conditions	Min	Max	Unit			
$V_{CBO}$	collector-base voltage	open emitter	-	-32	V			
$V_{CEO}$	collector-emitter voltage	open base	-	-20	V			
$V_{EBO}$	emitter-base voltage	open collector	-	-5	V			
$I_C$	collector current		-	-2	A			
$I_{CM}$	peak collector current	single pulse; $t_p \leq 1$ ms	-	-3	A			
$I_B$	base current		-	-0.4	A			
$I_{BM}$	peak base current	single pulse; $t_p \leq 1$ ms	-	-0.4	A			
$P_{tot}$	total power dissipation	$T_{amb} \leq 25$ °C						
			BCP69	[1]	-	0.65	W	
				[2]	-	1.00	W	
				[3]	-	1.35	W	
			BC869	[1]	-	0.50	W	
				[2]	-	0.95	W	
				[3]	-	1.35	W	
			BC69PA	[1]	-	0.42	W	
				[2]	-	0.83	W	
				[3]	-	1.10	W	
				[4]	-	0.81	W	
				[5]	-	1.65	W	
			$T_j$	junction temperature		-	150	°C
			$T_{amb}$	ambient temperature		-55	+150	°C
			$T_{stg}$	storage temperature		-65	+150	°C

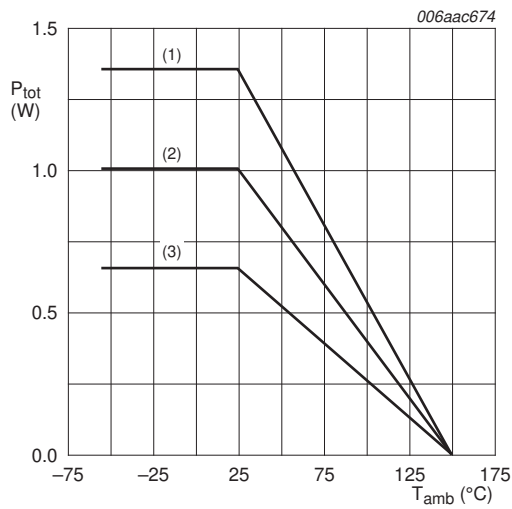
[1] Device mounted on an FR4 Printed-Circuit Board (PCB), single-sided copper, tin-plated and standard footprint.

[2] Device mounted on an FR4 PCB, single-sided copper, tin-plated, mounting pad for collector 1 cm<sup>2</sup>.

[3] Device mounted on an FR4 PCB, single-sided copper, tin-plated, mounting pad for collector 6 cm<sup>2</sup>.

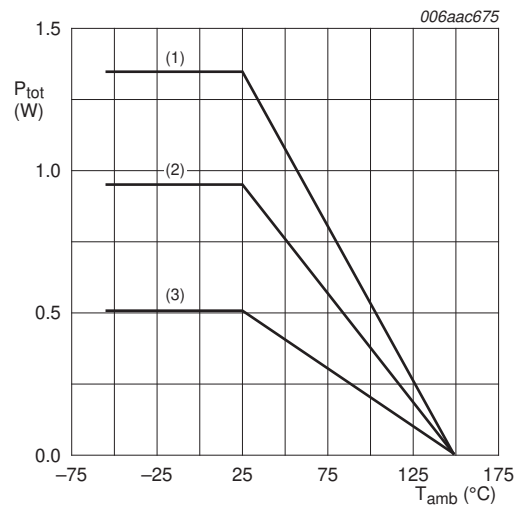
[4] Device mounted on an FR4 PCB, 4-layer copper, tin-plated and standard footprint.

[5] Device mounted on an FR4 PCB, 4-layer copper, tin-plated, mounting pad for collector 1 cm<sup>2</sup>.



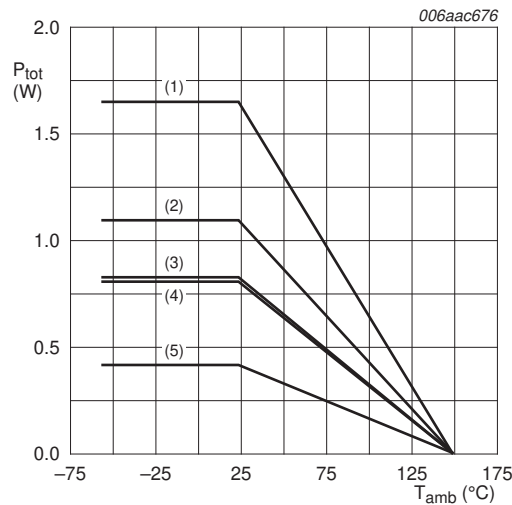
- (1) FR4 PCB, mounting pad for collector 6 cm<sup>2</sup>
- (2) FR4 PCB, mounting pad for collector 1 cm<sup>2</sup>
- (3) FR4 PCB, standard footprint

**Fig 1. Power derating curves SOT223**



- (1) FR4 PCB, mounting pad for collector 6 cm<sup>2</sup>
- (2) FR4 PCB, mounting pad for collector 1 cm<sup>2</sup>
- (3) FR4 PCB, standard footprint

**Fig 2. Power derating curves SOT89**



- (1) FR4 PCB, 4-layer copper, mounting pad for collector 1 cm<sup>2</sup>
- (2) FR4 PCB, single-sided copper, mounting pad for collector 6 cm<sup>2</sup>
- (3) FR4 PCB, single-sided copper, mounting pad for collector 1 cm<sup>2</sup>
- (4) FR4 PCB, 4-layer copper, standard footprint
- (5) FR4 PCB, single-sided copper, standard footprint

**Fig 3. Power derating curves SOT1061**

## 6. Thermal characteristics

**Table 7. Thermal characteristics**

Symbol	Parameter	Conditions	Min	Typ	Max	Unit							
$R_{th(j-a)}$	thermal resistance from junction to ambient	in free air	BCP69	[1]	-	-	192	K/W					
				[2]	-	-	125	K/W					
				[3]	-	-	93	K/W					
			BC869	[1]	-	-	250	K/W					
				[2]	-	-	132	K/W					
				[3]	-	-	93	K/W					
			BC69PA	[1]	-	-	298	K/W					
				[2]	-	-	151	K/W					
				[3]	-	-	114	K/W					
	[4]	-		-	154	K/W							
	[5]	-		-	76	K/W							
	$R_{th(j-sp)}$	thermal resistance from junction to solder point											
									BCP69	-	-	16	K/W
									BC869	-	-	16	K/W
									BC69PA	-	-	20	K/W

[1] Device mounted on an FR4 PCB, single-sided copper, tin-plated and standard footprint.

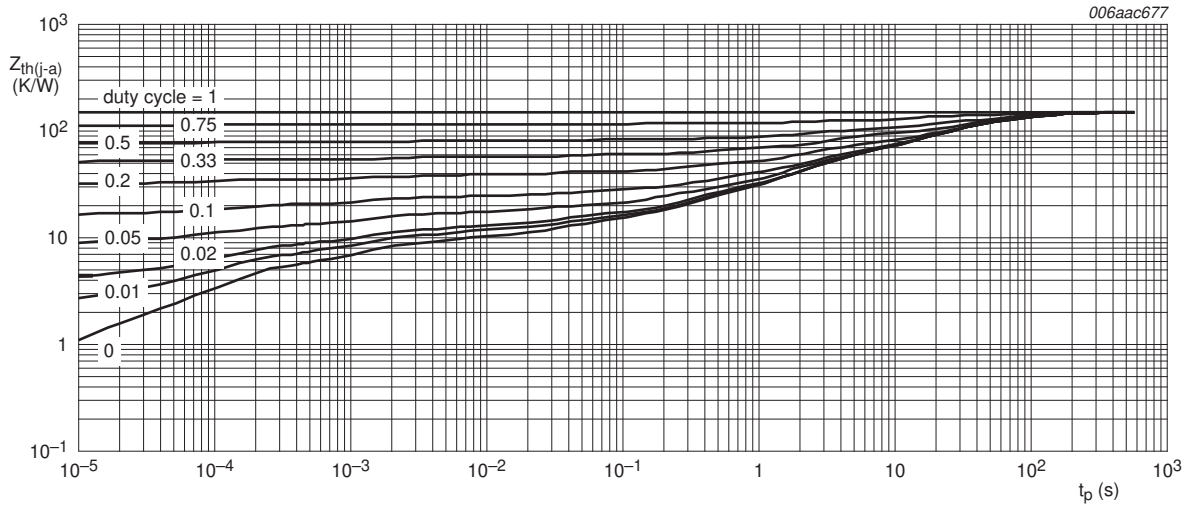
[2] Device mounted on an FR4 PCB, single-sided copper, tin-plated, mounting pad for collector 1 cm<sup>2</sup>.

[3] Device mounted on an FR4 PCB, single-sided copper, tin-plated, mounting pad for collector 6 cm<sup>2</sup>.

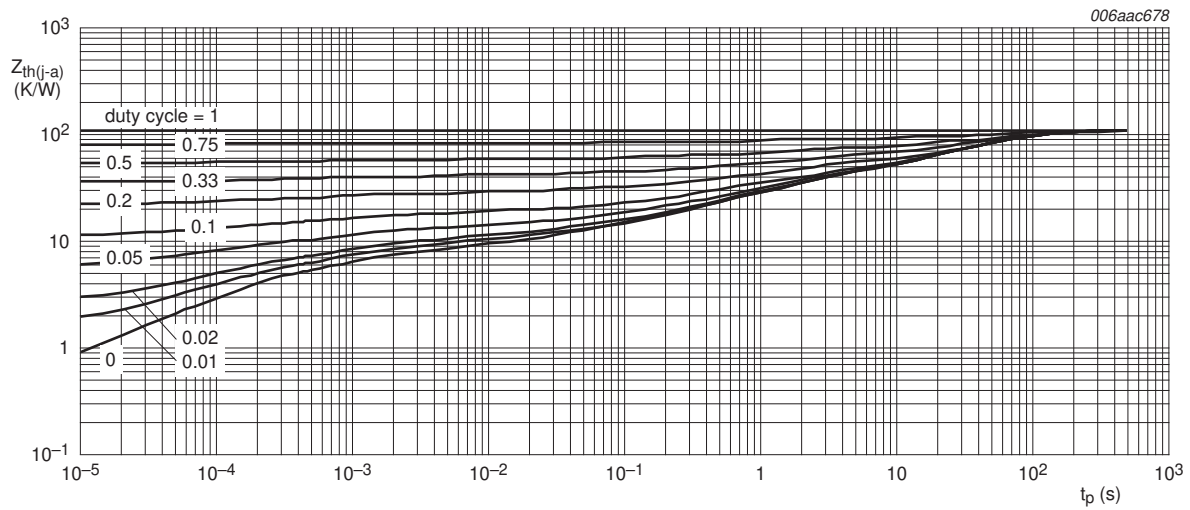
[4] Device mounted on an FR4 PCB, 4-layer copper, tin-plated and standard footprint.

[5] Device mounted on an FR4 PCB, 4-layer copper, tin-plated, mounting pad for collector 1 cm<sup>2</sup>.

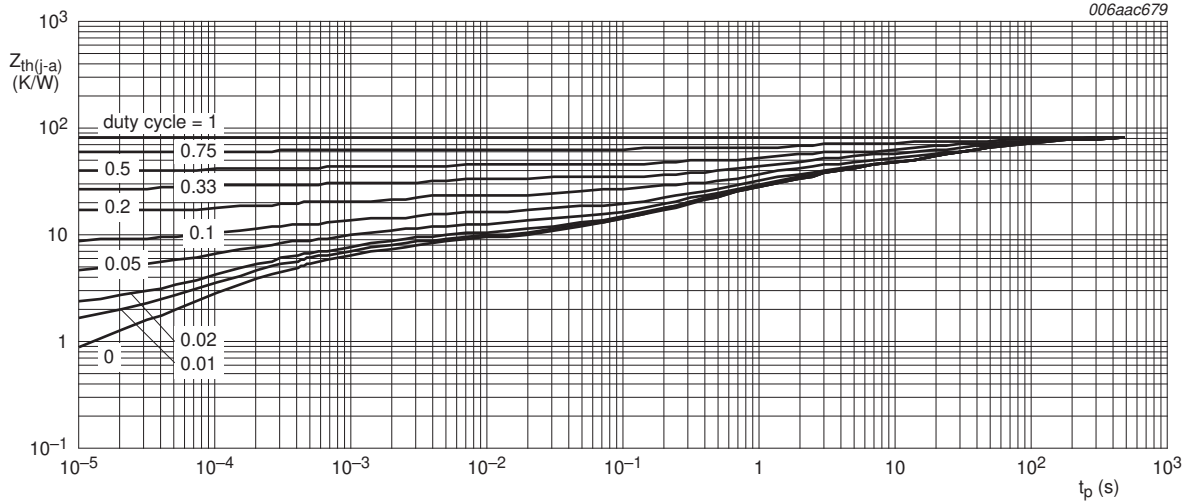




**Fig 4. Transient thermal impedance from junction to ambient as a function of pulse duration for SOT223; typical values**

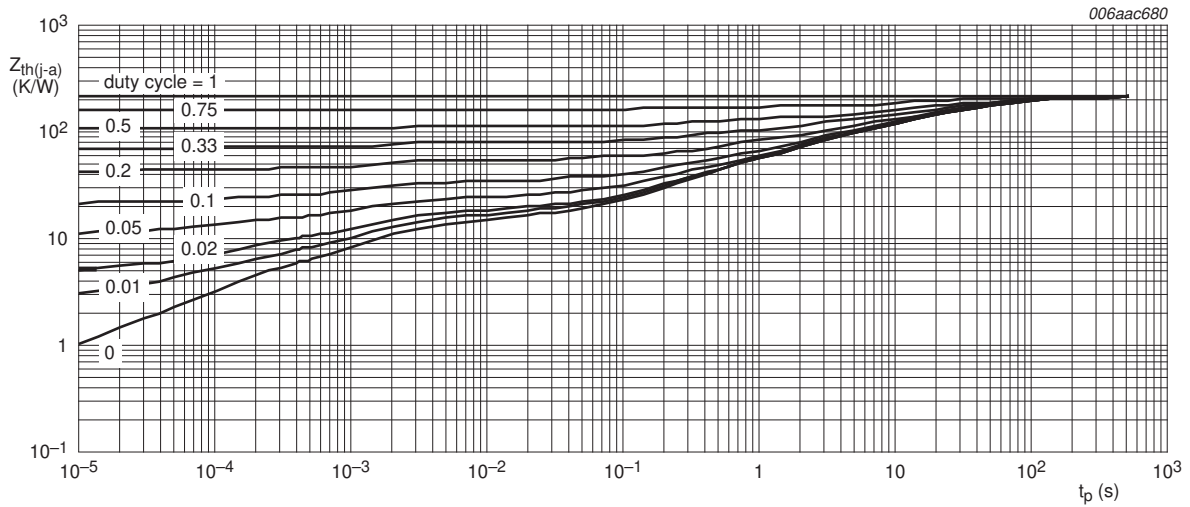


**Fig 5. Transient thermal impedance from junction to ambient as a function of pulse duration for SOT223; typical values**



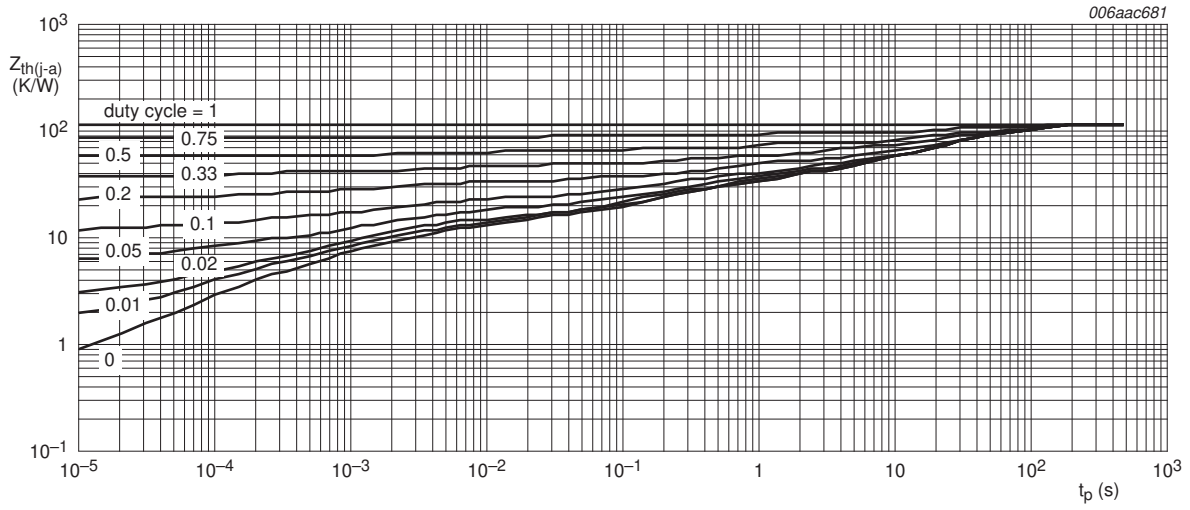
FR4 PCB, mounting pad for collector 6 cm<sup>2</sup>

**Fig 6. Transient thermal impedance from junction to ambient as a function of pulse duration for SOT223; typical values**



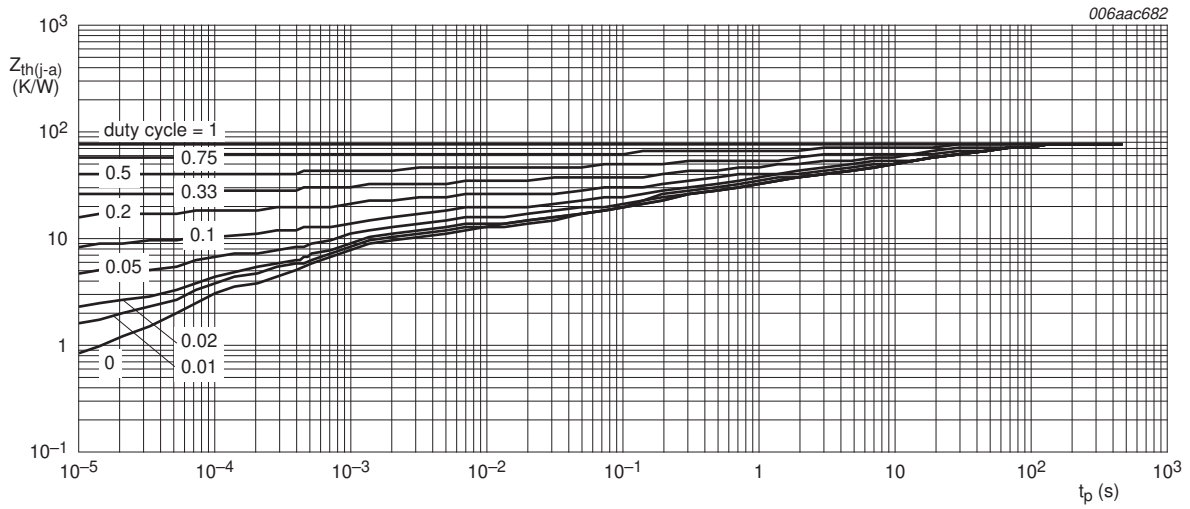
FR4 PCB, standard footprint

**Fig 7. Transient thermal impedance from junction to ambient as a function of pulse duration for SOT89; typical values**



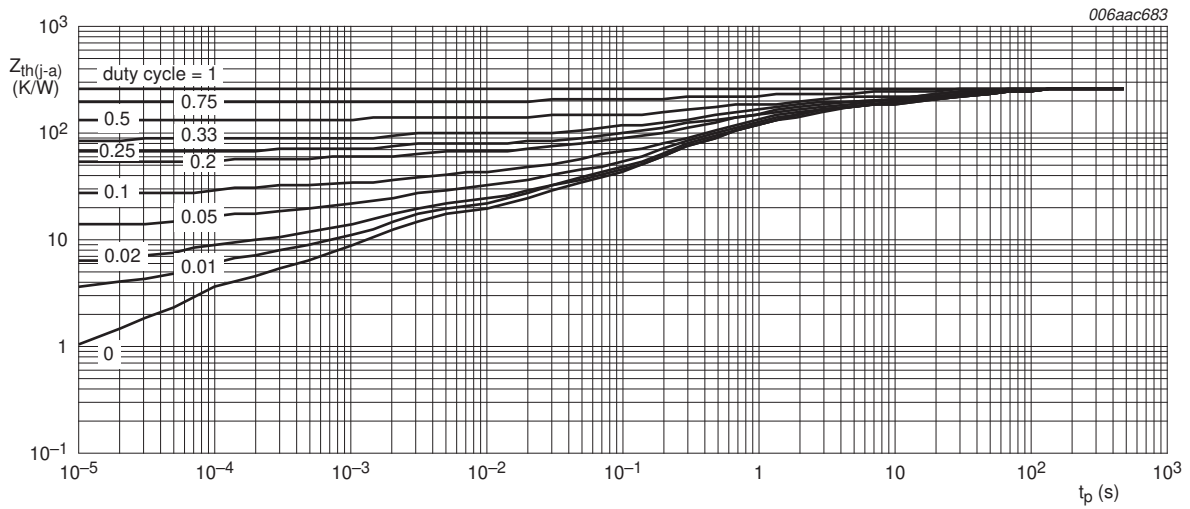
FR4 PCB, mounting pad for collector 1 cm<sup>2</sup>

**Fig 8. Transient thermal impedance from junction to ambient as a function of pulse duration for SOT89; typical values**



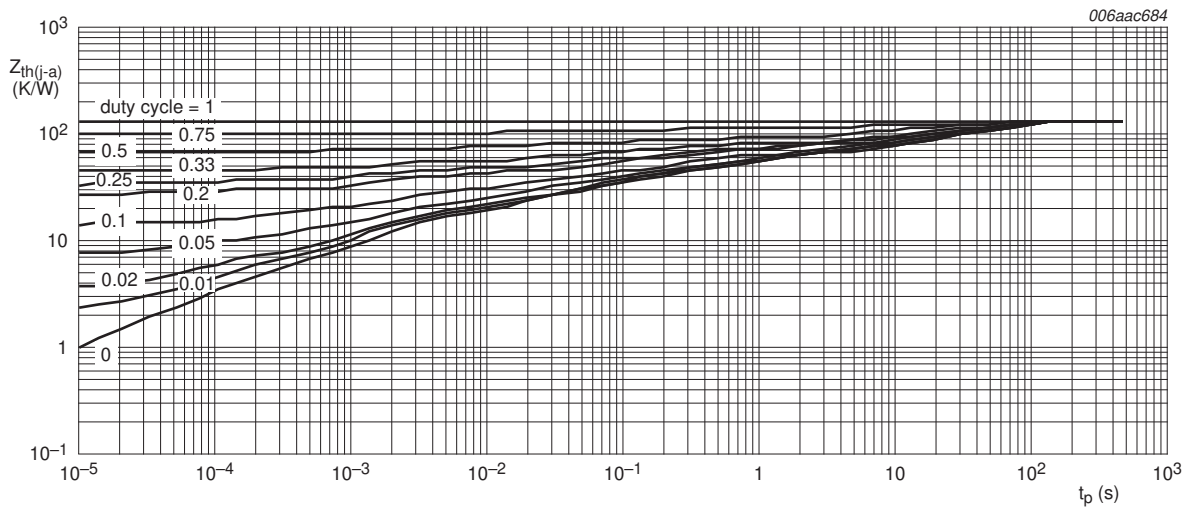
FR4 PCB, mounting pad for collector 6 cm<sup>2</sup>

**Fig 9. Transient thermal impedance from junction to ambient as a function of pulse duration for SOT89; typical values**



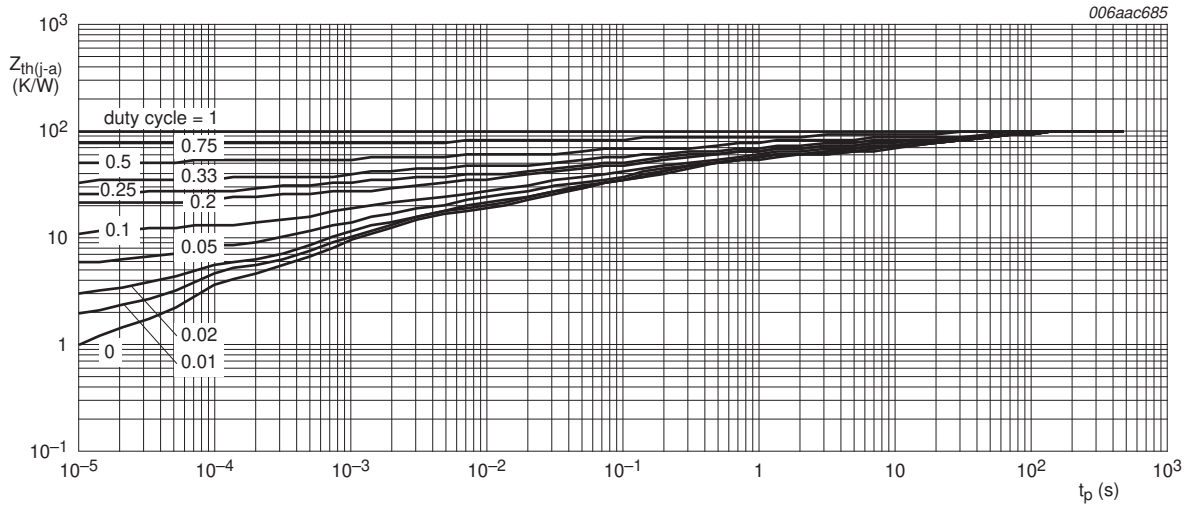
FR4 PCB, single-sided copper, standard footprint

**Fig 10. Transient thermal impedance from junction to ambient as a function of pulse duration for SOT1061; typical values**



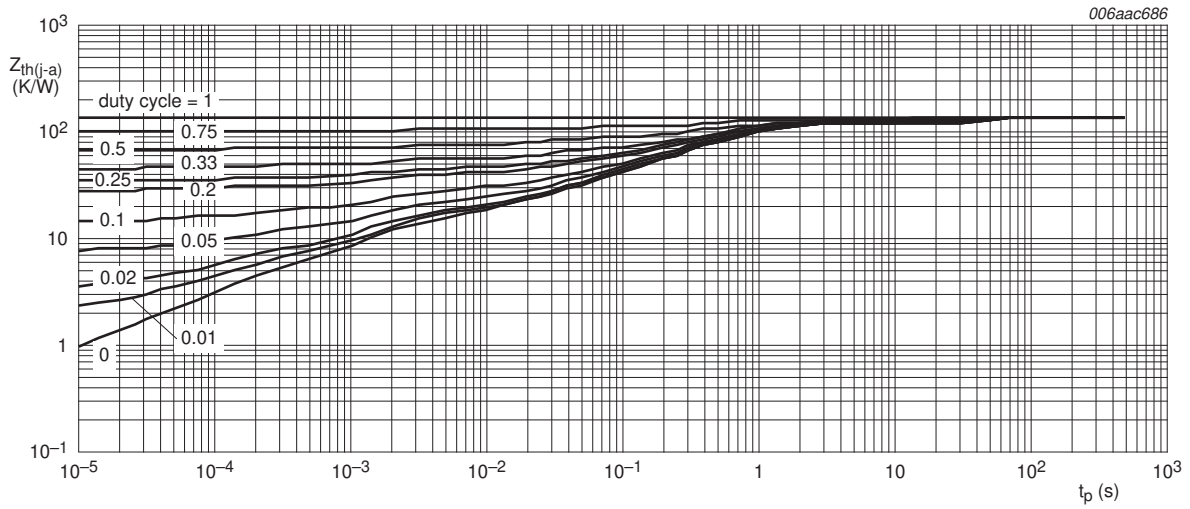
FR4 PCB, single-sided copper, mounting pad for collector 1 cm<sup>2</sup>

**Fig 11. Transient thermal impedance from junction to ambient as a function of pulse duration for SOT1061; typical values**



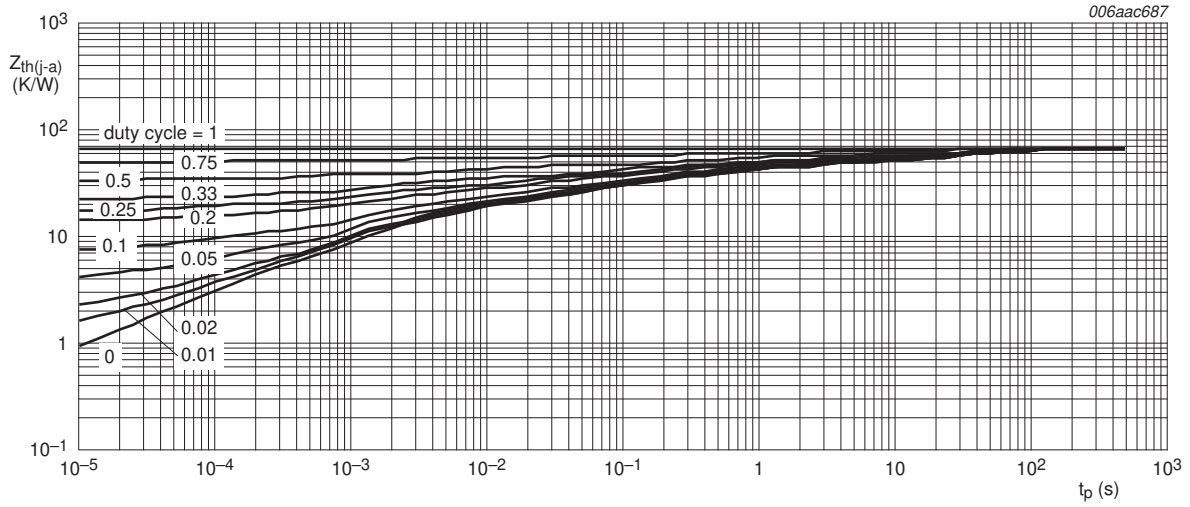
FR4 PCB, single-sided copper, mounting pad for collector 6 cm<sup>2</sup>

**Fig 12. Transient thermal impedance from junction to ambient as a function of pulse duration for SOT1061; typical values**



FR4 PCB, 4-layer copper, standard footprint

**Fig 13. Transient thermal impedance from junction to ambient as a function of pulse duration for SOT1061; typical values**



FR4 PCB, 4-layer copper, mounting pad for collector 1 cm<sup>2</sup>

**Fig 14. Transient thermal impedance from junction to ambient as a function of pulse duration for SOT1061; typical values**



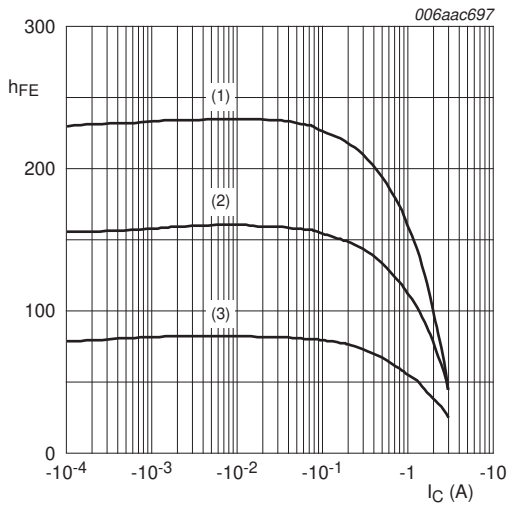
## 7. Characteristics

**Table 8. Characteristics**

$T_{amb} = 25\text{ }^{\circ}\text{C}$  unless otherwise specified.

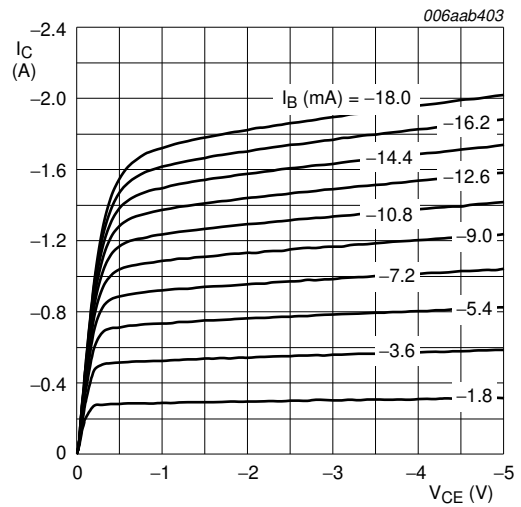
Symbol	Parameter	Conditions	Min	Typ	Max	Unit
$I_{CBO}$	collector-base cut-off current	$V_{CB} = -25\text{ V}; I_E = 0\text{ A}$	-	-	-100	nA
		$V_{CB} = -25\text{ V}; I_E = 0\text{ A}; T_j = 150\text{ }^{\circ}\text{C}$	-	-	-10	$\mu\text{A}$
$I_{EBO}$	emitter-base cut-off current	$V_{EB} = -5\text{ V}; I_C = 0\text{ A}$	-	-	-100	nA
$h_{FE}$	DC current gain	$V_{CE} = -10\text{ V}$				
		$I_C = -5\text{ mA}$	50	-	-	
	DC current gain	$V_{CE} = -1\text{ V}$				
		$I_C = -500\text{ mA}$	[1]	85	-	375
		$I_C = -1\text{ A}$	[1]	60	-	-
		$I_C = -2\text{ A}$	[1]	40	-	-
	DC current gain	$V_{CE} = -1\text{ V}$				
$h_{FE}$ selection -16	$I_C = -500\text{ mA}$	[1]	100	-	250	
$h_{FE}$ selection -25	$I_C = -500\text{ mA}$	[1]	160	-	375	
$V_{CEsat}$	collector-emitter saturation voltage	$I_C = -1\text{ A}; I_B = -100\text{ mA}$	[1]	-	-0.5	V
		$I_C = -2\text{ A}; I_B = -200\text{ mA}$	[1]	-	-0.6	V
$V_{BE}$	base-emitter voltage	$V_{CE} = -10\text{ V}; I_C = -5\text{ mA}$	[1]	-	-0.7	V
		$V_{CE} = -1\text{ V}; I_C = -1\text{ A}$	[1]	-	-1	V
$C_c$	collector capacitance	$V_{CB} = -10\text{ V}; I_E = I_e = 0\text{ A}; f = 1\text{ MHz}$	-	28	-	pF
$f_T$	transition frequency	$V_{CE} = -5\text{ V}; I_C = -50\text{ mA}; f = 100\text{ MHz}$	40	140	-	MHz

[1] Pulse test:  $t_p \leq 300\text{ }\mu\text{s}; \delta = 0.02$ .



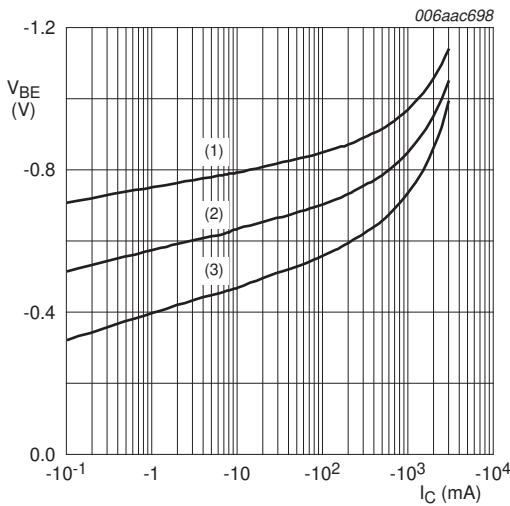
$V_{CE} = -1\text{ V}$   
 (1)  $T_{amb} = 100\text{ °C}$   
 (2)  $T_{amb} = 25\text{ °C}$   
 (3)  $T_{amb} = -55\text{ °C}$

**Fig 15.  $h_{FE}$  selection -16: DC current gain as a function of collector current; typical values**



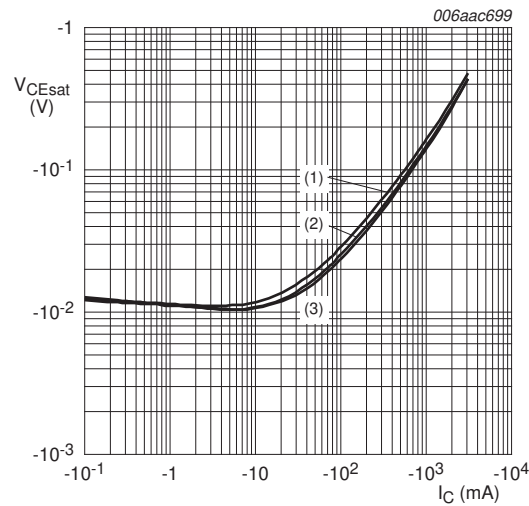
$T_{amb} = 25\text{ °C}$

**Fig 16.  $h_{FE}$  selection -16: collector current as a function of collector-emitter voltage; typical values**



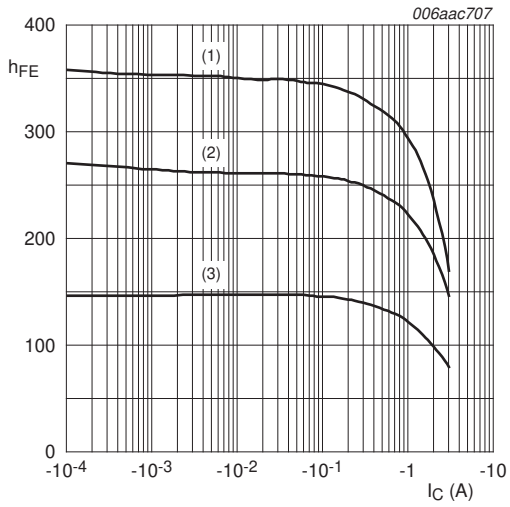
$V_{CE} = -1\text{ V}$   
 (1)  $T_{amb} = -55\text{ °C}$   
 (2)  $T_{amb} = 25\text{ °C}$   
 (3)  $T_{amb} = 100\text{ °C}$

**Fig 17.  $h_{FE}$  selection -16: base-emitter voltage as a function of collector current; typical values**



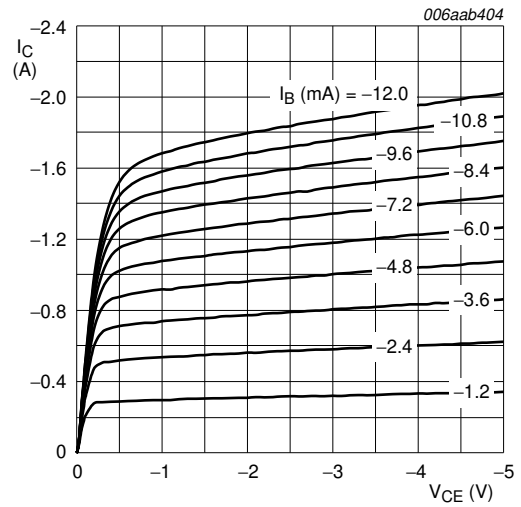
$I_C/I_B = 10$   
 (1)  $T_{amb} = 100\text{ °C}$   
 (2)  $T_{amb} = 25\text{ °C}$   
 (3)  $T_{amb} = -55\text{ °C}$

**Fig 18.  $h_{FE}$  selection -16: collector-emitter saturation voltage as a function of collector current; typical values**



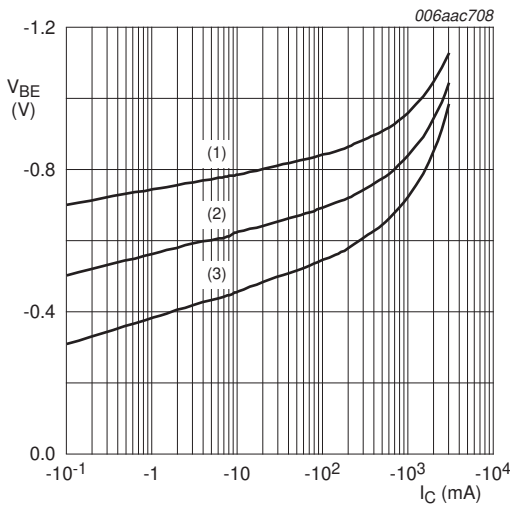
$V_{CE} = -1\text{ V}$   
 (1)  $T_{amb} = 100\text{ °C}$   
 (2)  $T_{amb} = 25\text{ °C}$   
 (3)  $T_{amb} = -55\text{ °C}$

**Fig 19.  $h_{FE}$  selection -25: DC current gain as a function of collector current; typical values**



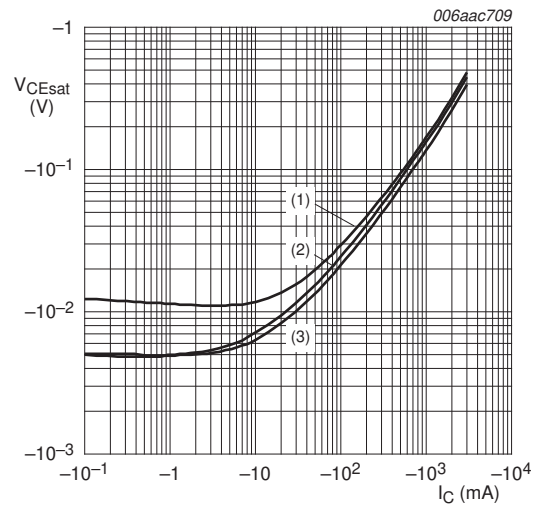
$T_{amb} = 25\text{ °C}$

**Fig 20.  $h_{FE}$  selection -25: collector current as a function of collector-emitter voltage; typical values**



$V_{CE} = -1\text{ V}$   
 (1)  $T_{amb} = -55\text{ °C}$   
 (2)  $T_{amb} = 25\text{ °C}$   
 (3)  $T_{amb} = 100\text{ °C}$

**Fig 21.  $h_{FE}$  selection -25: base-emitter voltage as a function of collector current; typical values**



$I_C/I_B = 10$   
 (1)  $T_{amb} = 100\text{ °C}$   
 (2)  $T_{amb} = 25\text{ °C}$   
 (3)  $T_{amb} = -55\text{ °C}$

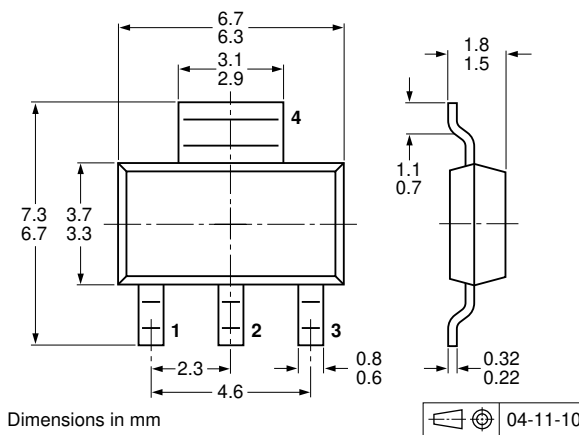
**Fig 22.  $h_{FE}$  selection -25: collector-emitter saturation voltage as a function of collector current; typical values**

## 8. Test information

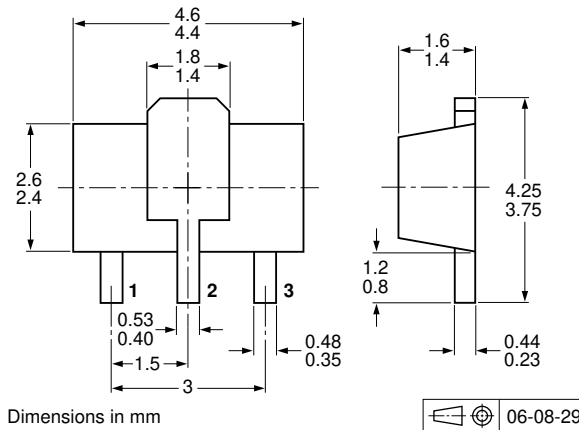
### 8.1 Quality information

This product has been qualified in accordance with the Automotive Electronics Council (AEC) standard *Q101 - Stress test qualification for discrete semiconductors*, and is suitable for use in automotive applications.

## 9. Package outline



**Fig 23. Package outline SOT223 (SC-73)**



**Fig 24. Package outline SOT89 (SC-62/TO-243)**

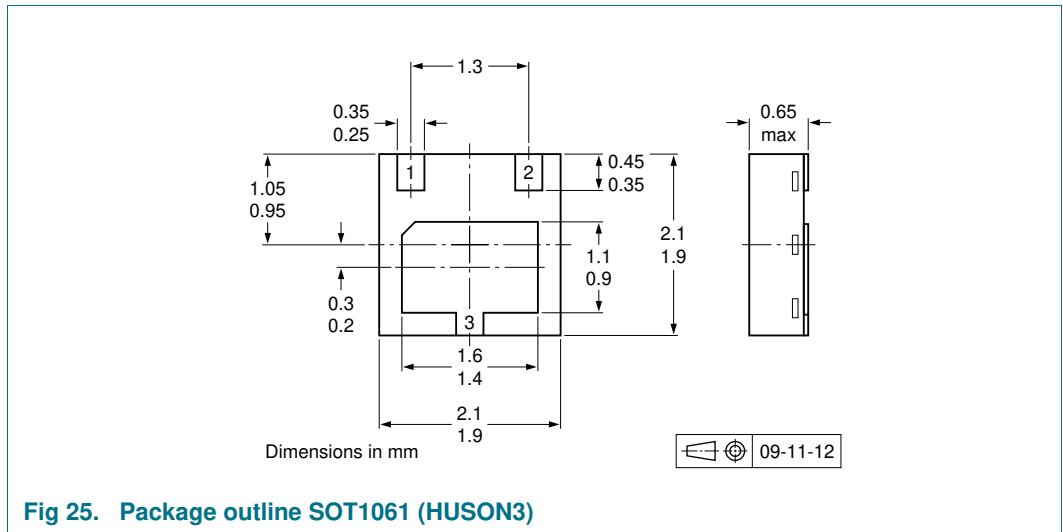


Fig 25. Package outline SOT1061 (HUSON3)

## 10. Packing information

**Table 9. Packing methods**

The indicated -xxx are the last three digits of the 12NC ordering code.<sup>[1]</sup>

Type number <sup>[2]</sup>	Package	Description	Packing quantity		
			1000	3000	4000
BCP69	SOT223	8 mm pitch, 12 mm tape and reel	-115	-	-135
BC869	SOT89	8 mm pitch, 12 mm tape and reel; T1 <sup>[3]</sup>	-115	-	-135
		8 mm pitch, 12 mm tape and reel; T3 <sup>[4]</sup>	-146	-	-
BC69PA	SOT1061	4 mm pitch, 8 mm tape and reel	-	-115	-

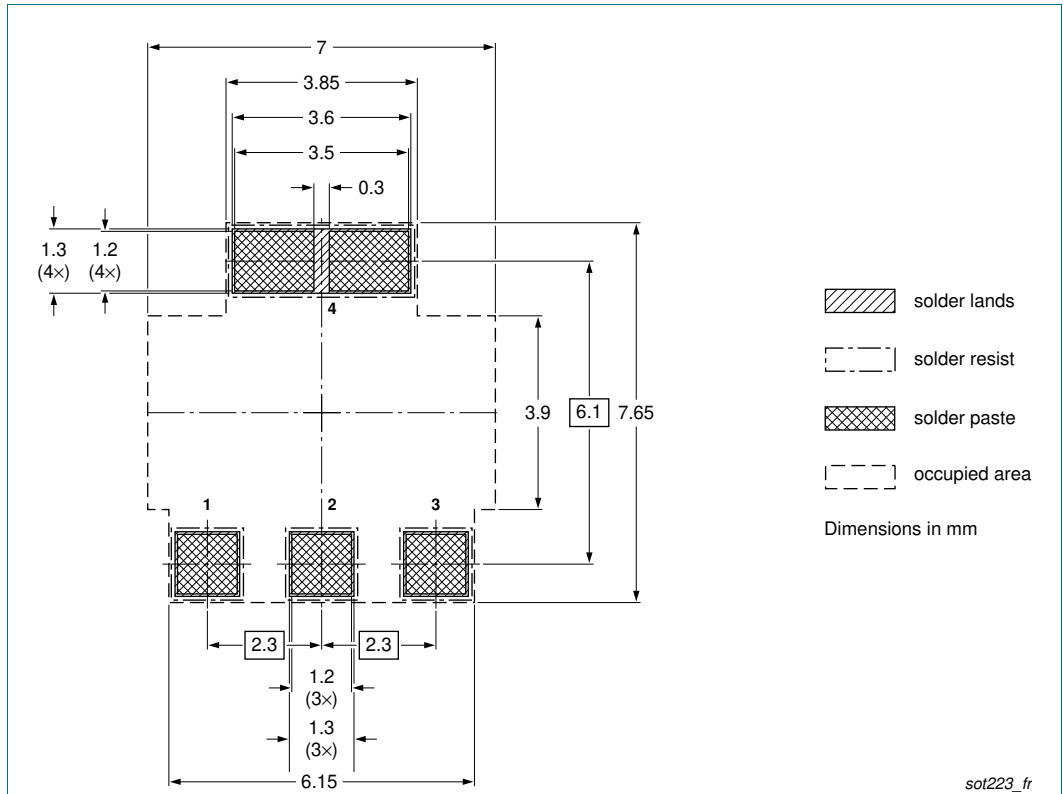
[1] For further information and the availability of packing methods, see [Section 14](#).

[2] Valid for all available selection groups.

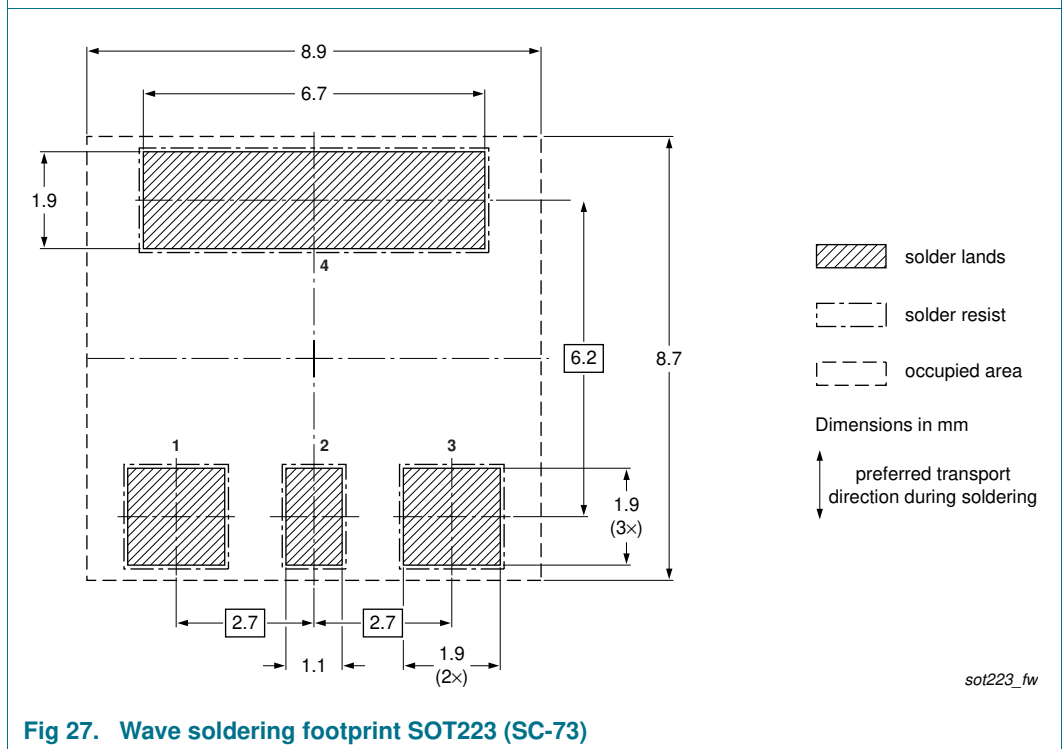
[3] T1: normal taping

[4] T3: 90° rotated taping

**11. Soldering**



**Fig 26. Reflow soldering footprint SOT223 (SC-73)**



**Fig 27. Wave soldering footprint SOT223 (SC-73)**







## 12. Revision history

Table 10. Revision history

Document ID	Release date	Data sheet status	Change notice	Supersedes
BCP69_BC869_BC69PA v.7	20111012	Product data sheet	-	BC869_6 BCP69_6
Modifications:		<ul style="list-style-type: none"> <li>• The format of this document has been redesigned to comply with the new identity guidelines of NXP Semiconductors.</li> <li>• Legal texts have been adapted to the new company name where appropriate.</li> <li>• Type number BC69PA added</li> <li>• Type number BCP69-16/DG and BCP69-16/IN removed</li> <li>• <a href="#">Section 1 “Product profile”</a>: updated</li> <li>• <a href="#">Section 2 “Pinning information”</a>: updated</li> <li>• <a href="#">Section 3 “Ordering information”</a>: updated</li> <li>• <a href="#">Section 4 “Marking”</a>: updated</li> <li>• <a href="#">Section 10 “Packing information”</a>: updated</li> <li>• <a href="#">Table 6, 7 and 8</a>: updated according to latest measurements</li> <li>• <a href="#">Figure 1, 15 to 18</a> updated</li> <li>• <a href="#">Figure 2 to 14, 24 to 25, 28 to 30</a>: added</li> </ul>		
BC869_6	20041108	Product data sheet	-	BC869_5
BC869_5	20031202	Product specification	-	BC869_4
BC869_4	19990408	Product specification	-	BC869_3
BC869_3	19980716	Product specification	-	BC869_CNV_2
BC869_CNV_2	19970401	Product specification	-	-
BCP69_6	20081202	Product data sheet	-	BCP69_5
BCP69_5	20031125	Product specification	-	BCP69_4
BCP69_4	20021115	Product specification	-	BCP69_3
BCP69_3	19990408	Product specification	-	BCP69_CNV_2
BCP69_CNV_2	19970312	Product specification	-	-

## 13. Legal information

### 13.1 Data sheet status

Document status <sup>[1][2]</sup>	Product status <sup>[3]</sup>	Definition
Objective [short] data sheet	Development	This document contains data from the objective specification for product development.
Preliminary [short] data sheet	Qualification	This document contains data from the preliminary specification.
Product [short] data sheet	Production	This document contains the product specification.

[1] Please consult the most recently issued document before initiating or completing a design.

[2] The term 'short data sheet' is explained in section "Definitions".

[3] The product status of device(s) described in this document may have changed since this document was published and may differ in case of multiple devices. The latest product status information is available on the Internet at URL <http://www.nxp.com>.

### 13.2 Definitions

**Draft** — The document is a draft version only. The content is still under internal review and subject to formal approval, which may result in modifications or additions. NXP Semiconductors does not give any representations or warranties as to the accuracy or completeness of information included herein and shall have no liability for the consequences of use of such information.

**Short data sheet** — A short data sheet is an extract from a full data sheet with the same product type number(s) and title. A short data sheet is intended for quick reference only and should not be relied upon to contain detailed and full information. For detailed and full information see the relevant full data sheet, which is available on request via the local NXP Semiconductors sales office. In case of any inconsistency or conflict with the short data sheet, the full data sheet shall prevail.

**Product specification** — The information and data provided in a Product data sheet shall define the specification of the product as agreed between NXP Semiconductors and its customer, unless NXP Semiconductors and customer have explicitly agreed otherwise in writing. In no event however, shall an agreement be valid in which the NXP Semiconductors product is deemed to offer functions and qualities beyond those described in the Product data sheet.

### 13.3 Disclaimers

**Limited warranty and liability** — Information in this document is believed to be accurate and reliable. However, NXP Semiconductors does not give any representations or warranties, expressed or implied, as to the accuracy or completeness of such information and shall have no liability for the consequences of use of such information.

In no event shall NXP Semiconductors be liable for any indirect, incidental, punitive, special or consequential damages (including - without limitation - lost profits, lost savings, business interruption, costs related to the removal or replacement of any products or rework charges) whether or not such damages are based on tort (including negligence), warranty, breach of contract or any other legal theory.

Notwithstanding any damages that customer might incur for any reason whatsoever, NXP Semiconductors' aggregate and cumulative liability towards customer for the products described herein shall be limited in accordance with the *Terms and conditions of commercial sale* of NXP Semiconductors.

**Right to make changes** — NXP Semiconductors reserves the right to make changes to information published in this document, including without limitation specifications and product descriptions, at any time and without notice. This document supersedes and replaces all information supplied prior to the publication hereof.

**Suitability for use** — NXP Semiconductors products are not designed, authorized or warranted to be suitable for use in life support, life-critical or safety-critical systems or equipment, nor in applications where failure or

malfunction of an NXP Semiconductors product can reasonably be expected to result in personal injury, death or severe property or environmental damage. NXP Semiconductors accepts no liability for inclusion and/or use of NXP Semiconductors products in such equipment or applications and therefore such inclusion and/or use is at the customer's own risk.

**Applications** — Applications that are described herein for any of these products are for illustrative purposes only. NXP Semiconductors makes no representation or warranty that such applications will be suitable for the specified use without further testing or modification.

Customers are responsible for the design and operation of their applications and products using NXP Semiconductors products, and NXP Semiconductors accepts no liability for any assistance with applications or customer product design. It is customer's sole responsibility to determine whether the NXP Semiconductors product is suitable and fit for the customer's applications and products planned, as well as for the planned application and use of customer's third party customer(s). Customers should provide appropriate design and operating safeguards to minimize the risks associated with their applications and products.

NXP Semiconductors does not accept any liability related to any default, damage, costs or problem which is based on any weakness or default in the customer's applications or products, or the application or use by customer's third party customer(s). Customer is responsible for doing all necessary testing for the customer's applications and products using NXP Semiconductors products in order to avoid a default of the applications and the products or of the application or use by customer's third party customer(s). NXP does not accept any liability in this respect.

**Limiting values** — Stress above one or more limiting values (as defined in the Absolute Maximum Ratings System of IEC 60134) will cause permanent damage to the device. Limiting values are stress ratings only and (proper) operation of the device at these or any other conditions above those given in the Recommended operating conditions section (if present) or the Characteristics sections of this document is not warranted. Constant or repeated exposure to limiting values will permanently and irreversibly affect the quality and reliability of the device.

**Terms and conditions of commercial sale** — NXP Semiconductors products are sold subject to the general terms and conditions of commercial sale, as published at <http://www.nxp.com/profile/terms>, unless otherwise agreed in a valid written individual agreement. In case an individual agreement is concluded only the terms and conditions of the respective agreement shall apply. NXP Semiconductors hereby expressly objects to applying the customer's general terms and conditions with regard to the purchase of NXP Semiconductors products by customer.

**No offer to sell or license** — Nothing in this document may be interpreted or construed as an offer to sell products that is open for acceptance or the grant, conveyance or implication of any license under any copyrights, patents or other industrial or intellectual property rights.

**Export control** — This document as well as the item(s) described herein may be subject to export control regulations. Export might require a prior authorization from competent authorities.

**Quick reference data** — The Quick reference data is an extract of the product data given in the Limiting values and Characteristics sections of this document, and as such is not complete, exhaustive or legally binding.

## 13.4 Trademarks

Notice: All referenced brands, product names, service names and trademarks are the property of their respective owners.

## 14. Contact information

---

For more information, please visit: <http://www.nxp.com>

For sales office addresses, please send an email to: [salesaddresses@nxp.com](mailto:salesaddresses@nxp.com)

## 15. Contents

<b>1</b>	<b>Product profile</b> . . . . .	<b>1</b>
1.1	General description . . . . .	1
1.2	Features and benefits . . . . .	1
1.3	Applications . . . . .	1
1.4	Quick reference data . . . . .	1
<b>2</b>	<b>Pinning information</b> . . . . .	<b>2</b>
<b>3</b>	<b>Ordering information</b> . . . . .	<b>3</b>
<b>4</b>	<b>Marking</b> . . . . .	<b>3</b>
<b>5</b>	<b>Limiting values</b> . . . . .	<b>4</b>
<b>6</b>	<b>Thermal characteristics</b> . . . . .	<b>6</b>
<b>7</b>	<b>Characteristics</b> . . . . .	<b>13</b>
<b>8</b>	<b>Test information</b> . . . . .	<b>16</b>
8.1	Quality information . . . . .	16
<b>9</b>	<b>Package outline</b> . . . . .	<b>16</b>
<b>10</b>	<b>Packing information</b> . . . . .	<b>17</b>
<b>11</b>	<b>Soldering</b> . . . . .	<b>18</b>
<b>12</b>	<b>Revision history</b> . . . . .	<b>21</b>
<b>13</b>	<b>Legal information</b> . . . . .	<b>22</b>
13.1	Data sheet status . . . . .	22
13.2	Definitions . . . . .	22
13.3	Disclaimers . . . . .	22
13.4	Trademarks . . . . .	23
<b>14</b>	<b>Contact information</b> . . . . .	<b>23</b>
<b>15</b>	<b>Contents</b> . . . . .	<b>24</b>

Please be aware that important notices concerning this document and the product(s) described herein, have been included in section 'Legal information'.

© NXP B.V. 2011.

All rights reserved.

For more information, please visit: <http://www.nxp.com>

For sales office addresses, please send an email to: [salesaddresses@nxp.com](mailto:salesaddresses@nxp.com)

Date of release: 12 October 2011

Document identifier: BCP69\_BC869\_BC69PA