



Chipsmall Limited consists of a professional team with an average of over 10 year of expertise in the distribution of electronic components. Based in Hongkong, we have already established firm and mutual-benefit business relationships with customers from,Europe,America and south Asia,supplying obsolete and hard-to-find components to meet their specific needs.

With the principle of “Quality Parts,Customers Priority,Honest Operation,and Considerate Service”,our business mainly focus on the distribution of electronic components. Line cards we deal with include Microchip,ALPS,ROHM,Xilinx,Pulse,ON,Everlight and Freescale. Main products comprise IC,Modules,Potentiometer,IC Socket,Relay,Connector.Our parts cover such applications as commercial,industrial, and automotives areas.

We are looking forward to setting up business relationship with you and hope to provide you with the best service and solution. Let us make a better world for our industry!



## Contact us

Tel: +86-755-8981 8866 Fax: +86-755-8427 6832

Email & Skype: info@chipsmall.com Web: www.chipsmall.com

Address: A1208, Overseas Decoration Building, #122 Zhenhua RD., Futian, Shenzhen, China



**PNP Silicon Digital Transistor**

- Switching circuit, inverter, interface circuit, driver circuit
- Built in bias resistor ( $R_1 = 10\text{ k}\Omega$  ,  $R_2 = 47\text{ k}\Omega$  )
- BCR185S / U: Two internally isolated transistors with good matching in one multichip package

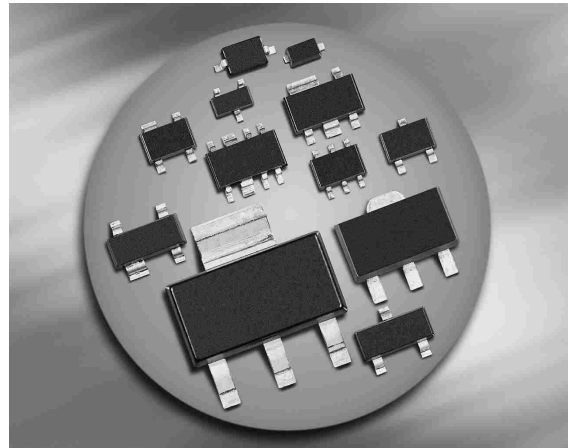

**BCR185/F/L3  
BCR185T/W**

**BCR185S/U**

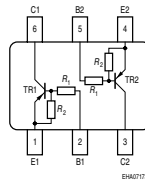
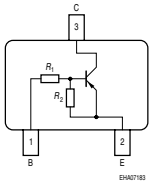

Type	Marking	Pin Configuration						Package
BCR185	WNs	1=B	2=E	3=C	-	-	-	SOT23
BCR185F	WNs	1=B	2=E	3=C	-	-	-	TSFP-3
BCR185L3	WN	1=B	2=E	3=C	-	-	-	TSLP-3-4
BCR185S	WNs	1=E1	2=B1	3=C2	4=E2	5=B2	6=C1	SOT363
BCR185T	WNs	1=B	2=E	3=C	-	-	-	SC75
BCR185U	WNs	1=E1	2=B1	3=C2	4=E2	5=B2	6=C1	SC74
BCR185W	WNs	1=B	2=E	3=C	-	-	-	SOT323

**Maximum Ratings**

Parameter	Symbol	Value	Unit
Collector-emitter voltage	$V_{CEO}$	50	V
Collector-base voltage	$V_{CBO}$	50	
Emitter-base voltage	$V_{EBO}$	6	
Input on voltage	$V_{i(on)}$	20	
Collector current	$I_C$	100	mA
Total power dissipation- BCR185 $T_S \leq 102^\circ\text{C}$ BCR185F, $T_S \leq 128^\circ\text{C}$ BCR185L3, $T_S \leq 135^\circ\text{C}$ BCR185S, $T_S \leq 115^\circ\text{C}$ BCR185T, $T_S \leq 109^\circ\text{C}$ BCR185U, $T_S \leq 118^\circ\text{C}$ BCR185W, $T_S \leq 124^\circ\text{C}$	$P_{tot}$	200 250 250 250 250 250 250	mW
Junction temperature	$T_j$	150	°C
Storage temperature	$T_{stg}$	-65 ... 150	

**Thermal Resistance**

Parameter	Symbol	Value	Unit
Junction - soldering point <sup>1)</sup>	$R_{thJS}$		K/W
BCR185		$\leq 240$	
BCR185F		$\leq 90$	
BCR185L3		$\leq 60$	
BCR185S		$\leq 140$	
BCR185T		$\leq 165$	
BCR185U		$\leq 133$	
BCR185W		$\leq 105$	

<sup>1</sup>For calculation of  $R_{thJA}$  please refer to Application Note Thermal Resistance

**Electrical Characteristics at  $T_A = 25^\circ\text{C}$ , unless otherwise specified**

Parameter	Symbol	Values			Unit
		min.	typ.	max.	
<b>DC Characteristics</b>					
Collector-emitter breakdown voltage $I_C = 100 \mu\text{A}, I_B = 0$	$V_{(BR)CEO}$	50	-	-	V
Collector-base breakdown voltage $I_C = 10 \mu\text{A}, I_E = 0$	$V_{(BR)CBO}$	50	-	-	
Collector-base cutoff current $V_{CB} = 40 \text{ V}, I_E = 0$	$I_{CBO}$	-	-	100	nA
Emitter-base cutoff current $V_{EB} = 6 \text{ V}, I_C = 0$	$I_{EBO}$	-	-	167	$\mu\text{A}$
DC current gain <sup>1)</sup> $I_C = 5 \text{ mA}, V_{CE} = 5 \text{ V}$	$h_{FE}$	70	-	-	-
Collector-emitter saturation voltage <sup>1)</sup> $I_C = 10 \text{ mA}, I_B = 0,5 \text{ mA}$	$V_{CEsat}$	-	-	0.3	V
Input off voltage $I_C = 100 \mu\text{A}, V_{CE} = 5 \text{ V}$	$V_{i(off)}$	0.5	-	1	
Input on voltage $I_C = 2 \text{ mA}, V_{CE} = 0,3 \text{ V}$	$V_{i(on)}$	0.5	-	1.4	
Input resistor	$R_1$	7	10	13	$\text{k}\Omega$
Resistor ratio	$R_1/R_2$	0.19	0.21	0.24	-
<b>AC Characteristics</b>					
Transition frequency $I_C = 10 \text{ mA}, V_{CE} = 5 \text{ V}, f = 100 \text{ MHz}$	$f_T$	-	200	-	MHz
Collector-base capacitance $V_{CB} = 10 \text{ V}, f = 1 \text{ MHz}$	$C_{cb}$	-	3	-	pF

<sup>1</sup>Pulse test:  $t < 300 \mu\text{s}$ ;  $D < 2\%$

**DC current gain  $h_{FE} = f(I_C)$**

$V_{CE} = 5\text{ V}$  (common emitter configuration)

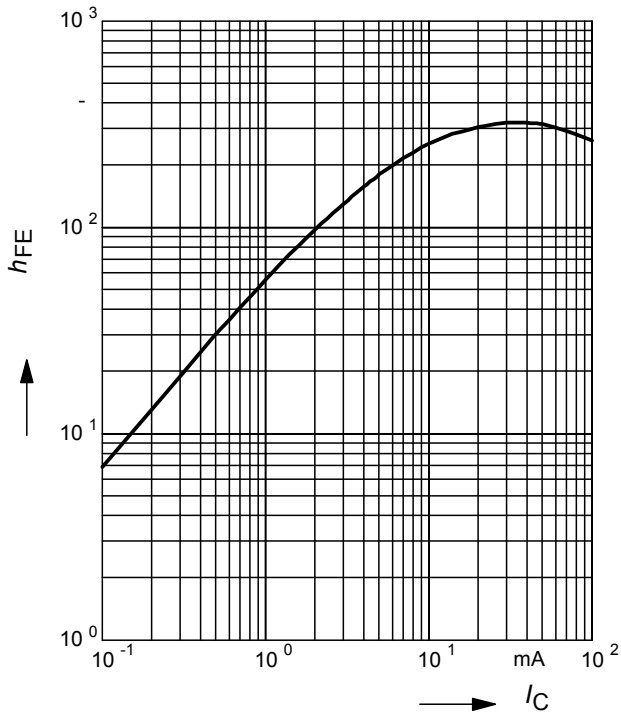

**Collector-emitter saturation voltage**

$V_{CEsat} = f(I_C), h_{FE} = 20$

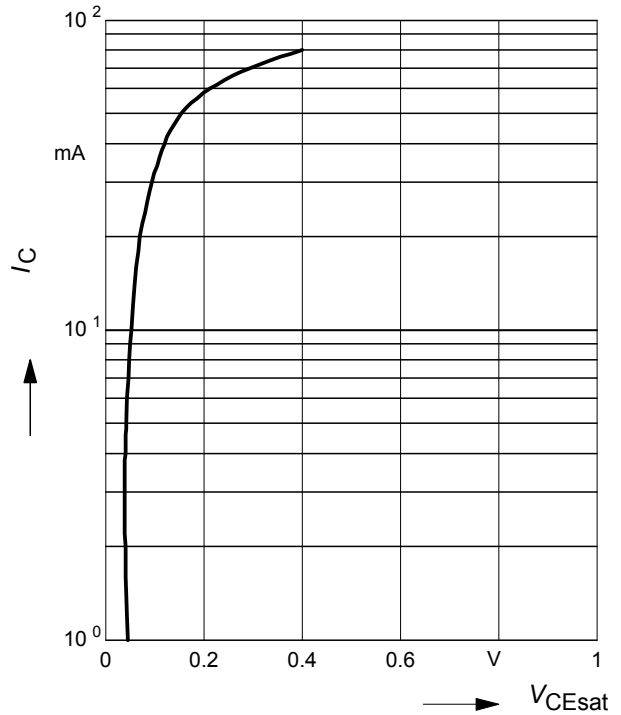

**Input on Voltage  $V_{i(on)} = f(I_C)$**

$V_{CE} = 0.3\text{ V}$  (common emitter configuration)

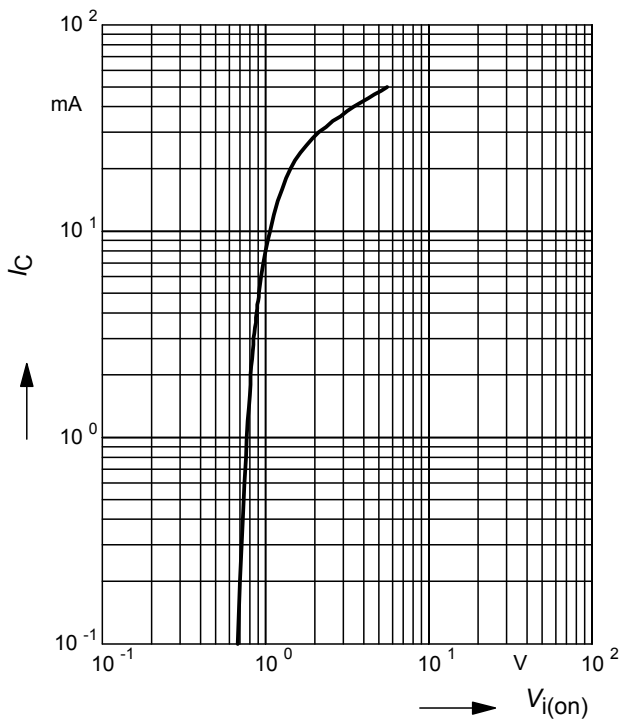

**Input off voltage  $V_{i(off)} = f(I_C)$**

$V_{CE} = 5\text{ V}$  (common emitter configuration)

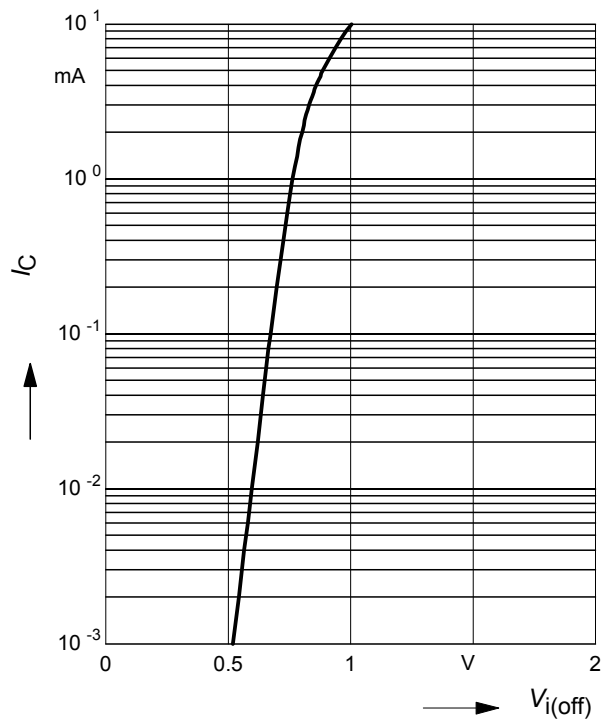

Total power dissipation  $P_{tot} = f(T_S)$

BCR185

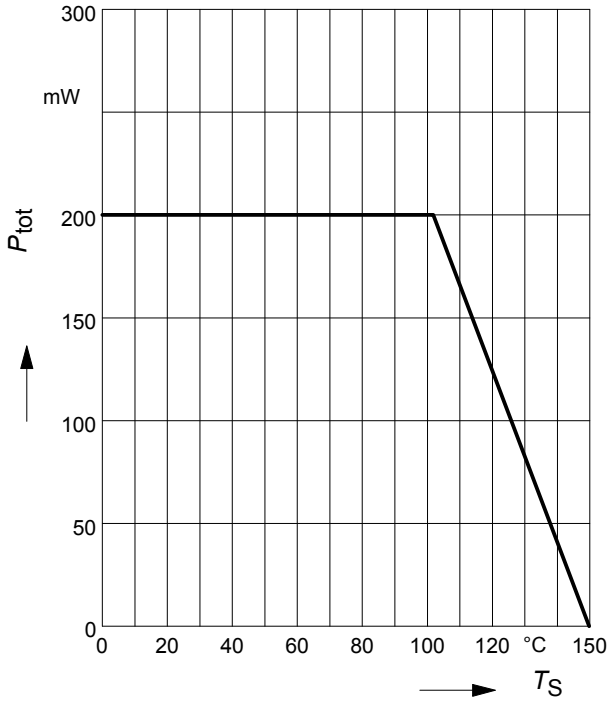

Total power dissipation  $P_{tot} = f(T_S)$

BCR185F

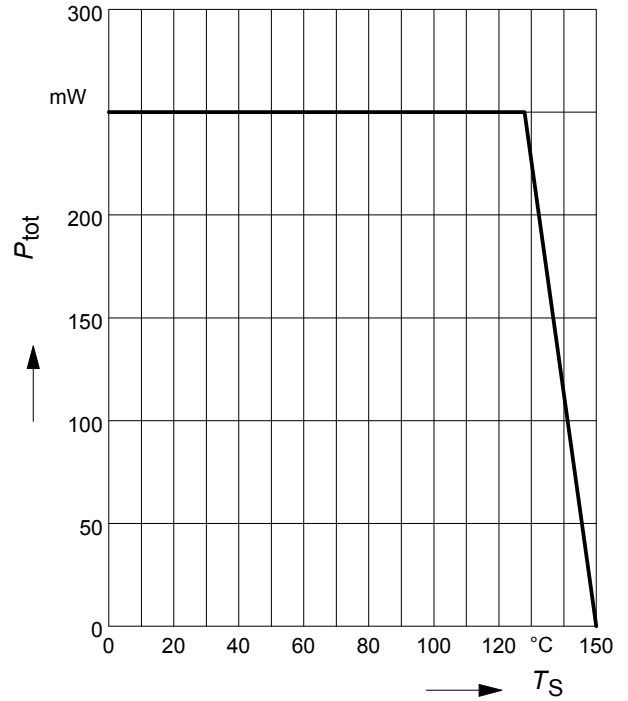

Total power dissipation  $P_{tot} = f(T_S)$

BCR185L3

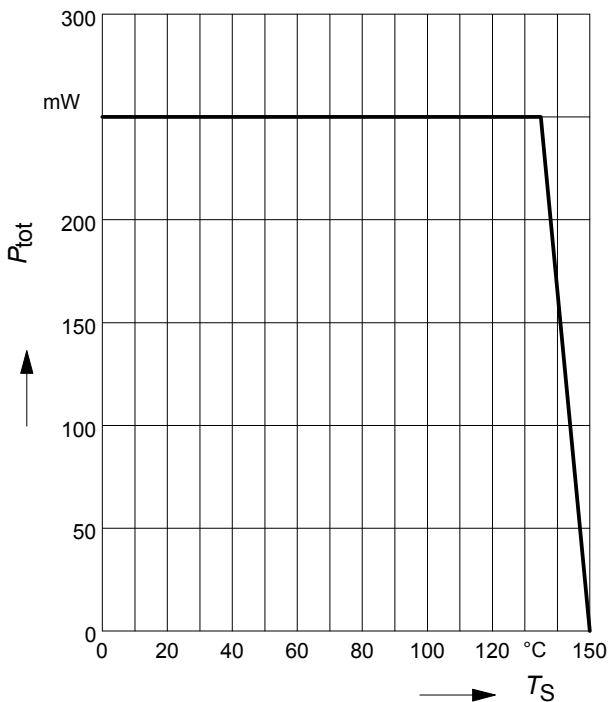

Total power dissipation  $P_{tot} = f(T_S)$

BCR185S

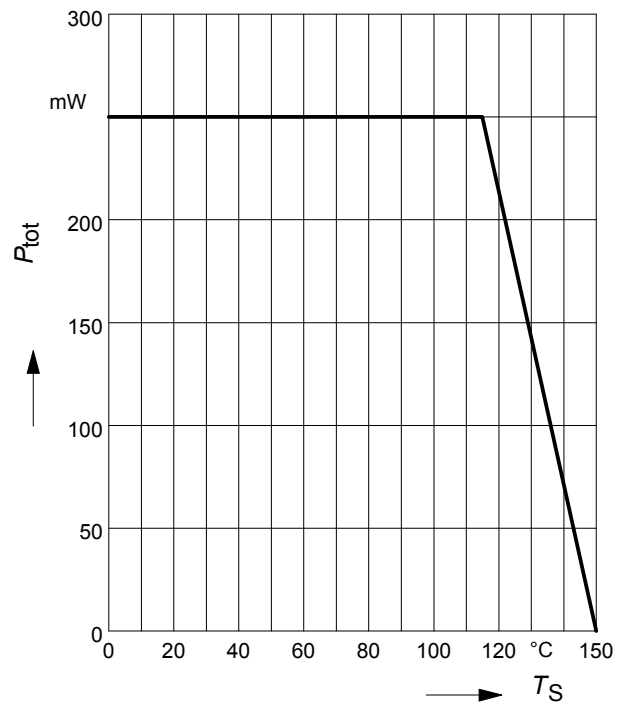

Total power dissipation  $P_{tot} = f(T_S)$

BCR185T

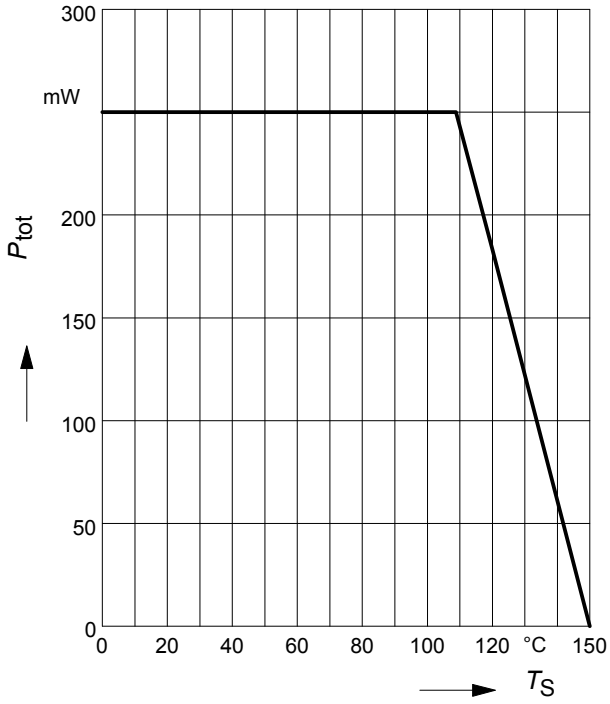

Total power dissipation  $P_{tot} = f(T_S)$

BCR185U

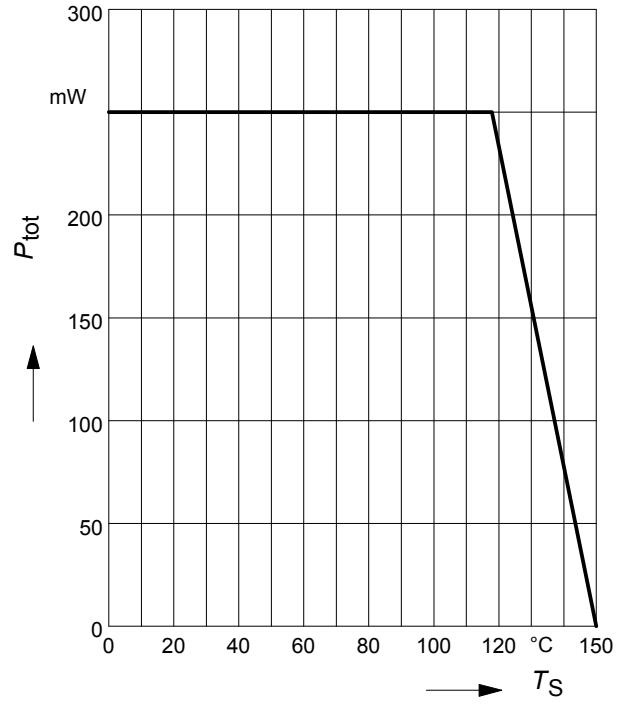

Total power dissipation  $P_{tot} = f(T_S)$

BCR185W

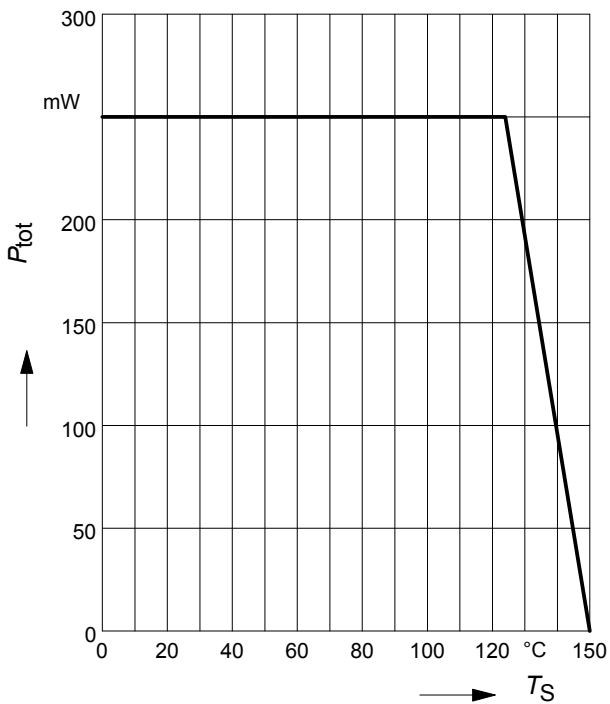

**Permissible Pulse Load  $R_{thJS} = f(t_p)$**

BCR185

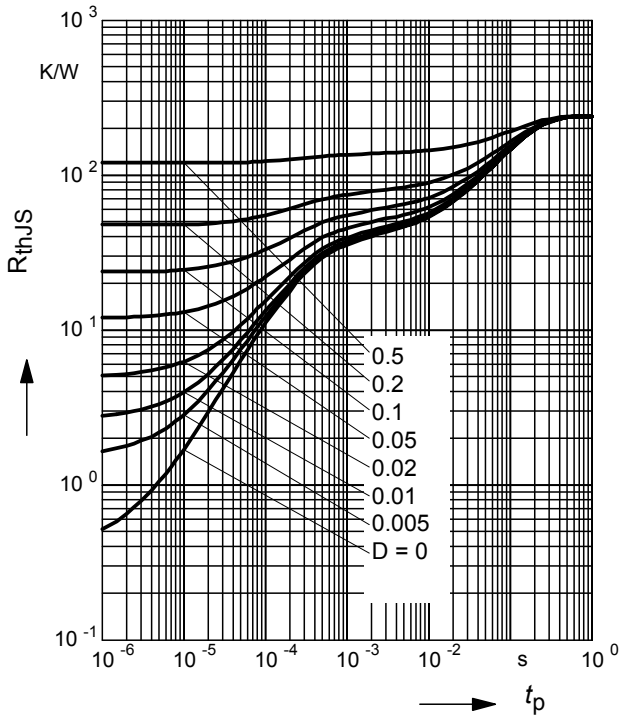

**Permissible Pulse Load**

$P_{totmax}/P_{totDC} = f(t_p)$

BCR185

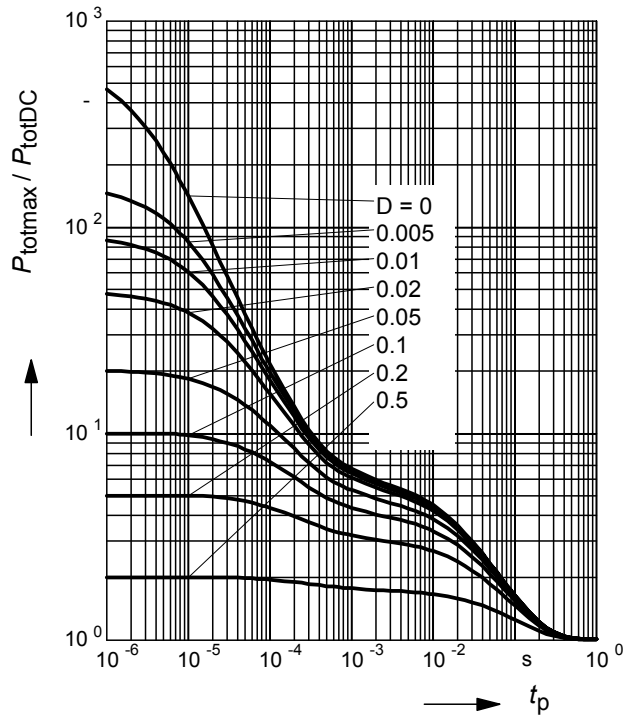

**Permissible Puls Load  $R_{thJS} = f(t_p)$**

BCR185F

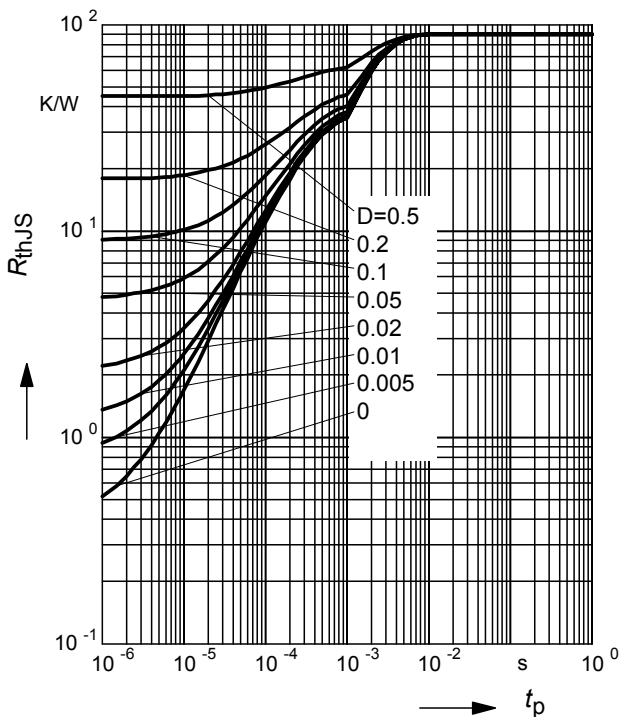

**Permissible Pulse Load**

$P_{totmax}/P_{totDC} = f(t_p)$

BCR185F

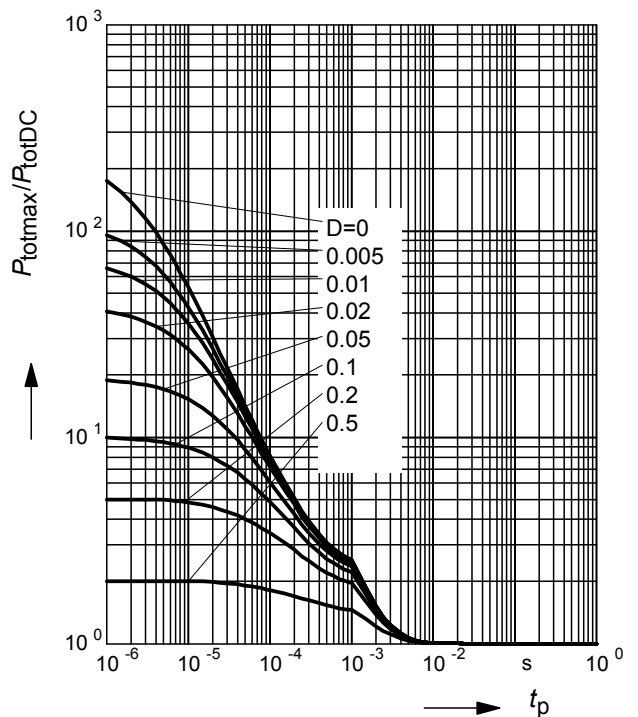



**Permissible Puls Load  $R_{thJS} = f(t_p)$**

BCR185L3

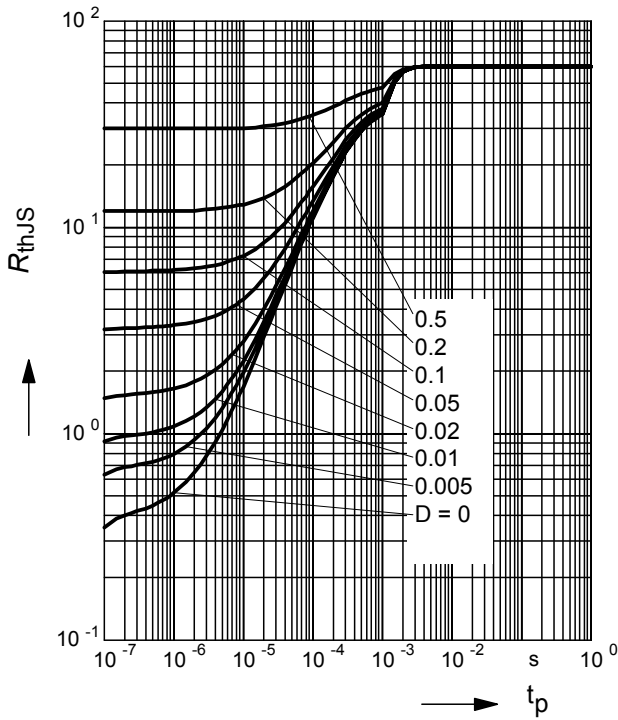

**Permissible Pulse Load**

$P_{totmax}/P_{totDC} = f(t_p)$

BCR185L3

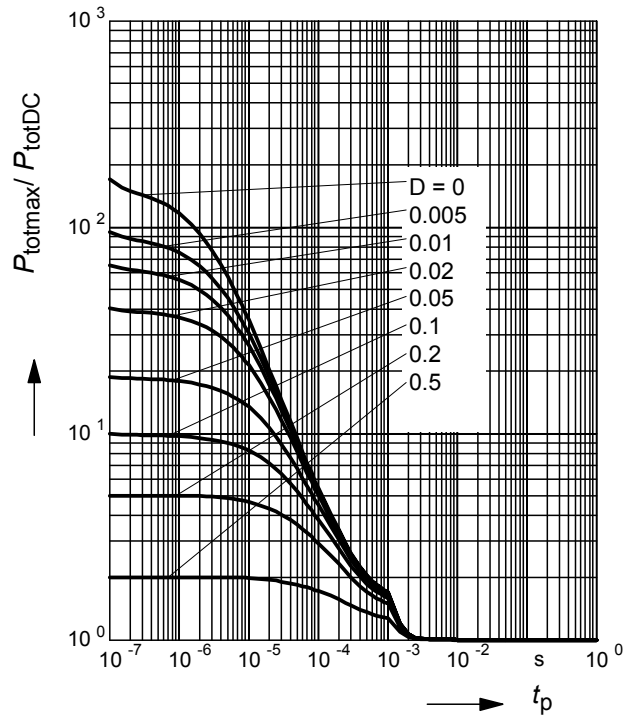

**Permissible Puls Load  $R_{thJS} = f(t_p)$**

BCR185S

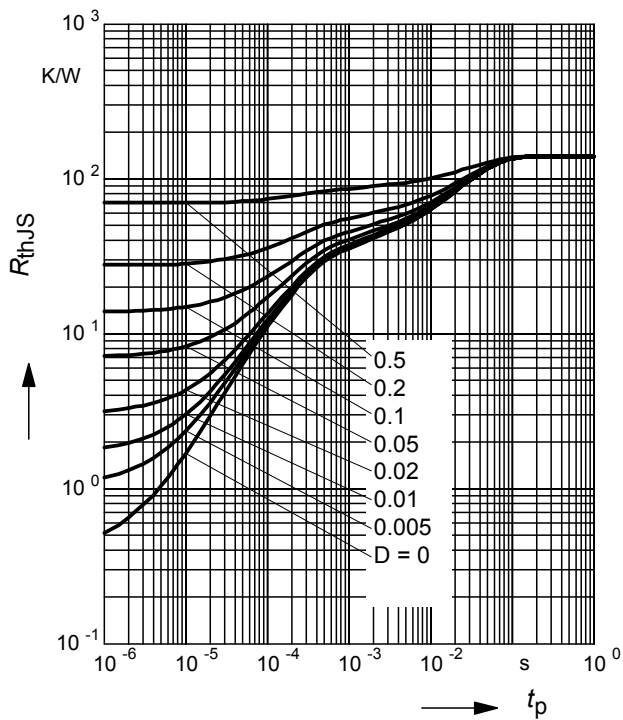

**Permissible Pulse Load**

$P_{totmax}/P_{totDC} = f(t_p)$

BCR185S

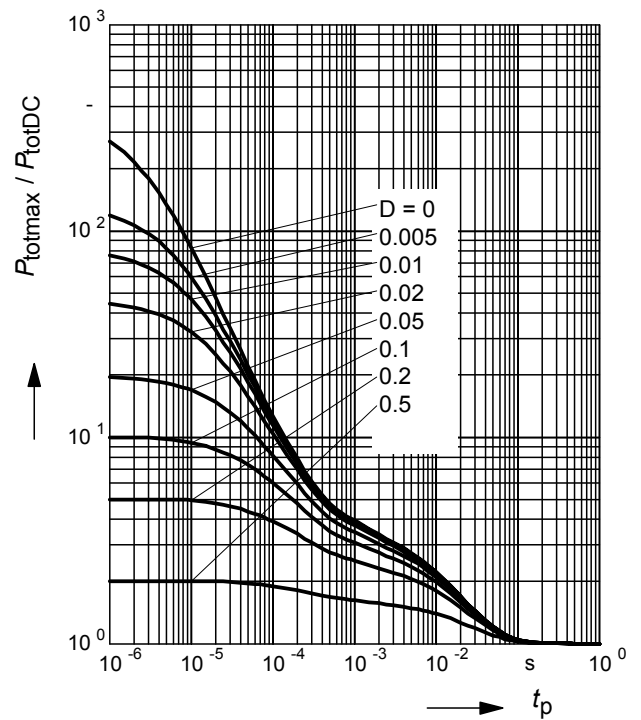

**Permissible Puls Load  $R_{thJS} = f(t_p)$**

BCR185T

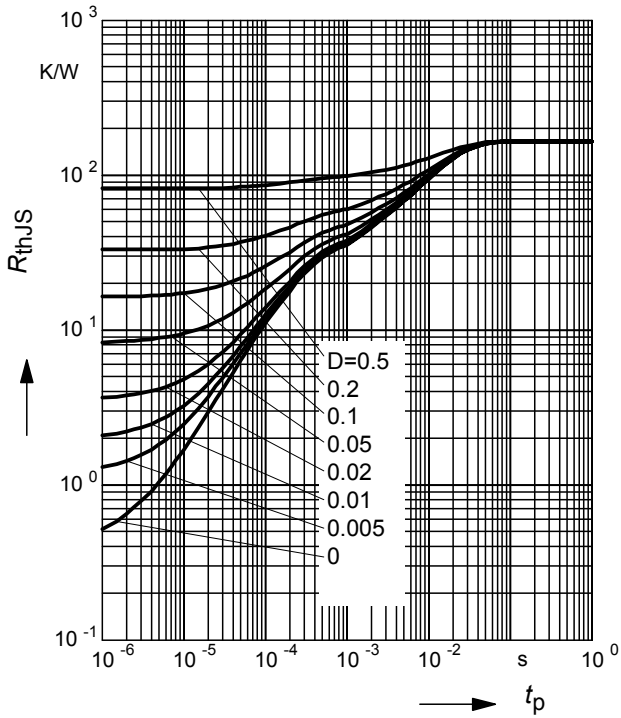

**Permissible Pulse Load**

$P_{totmax}/P_{totDC} = f(t_p)$

BCR185T

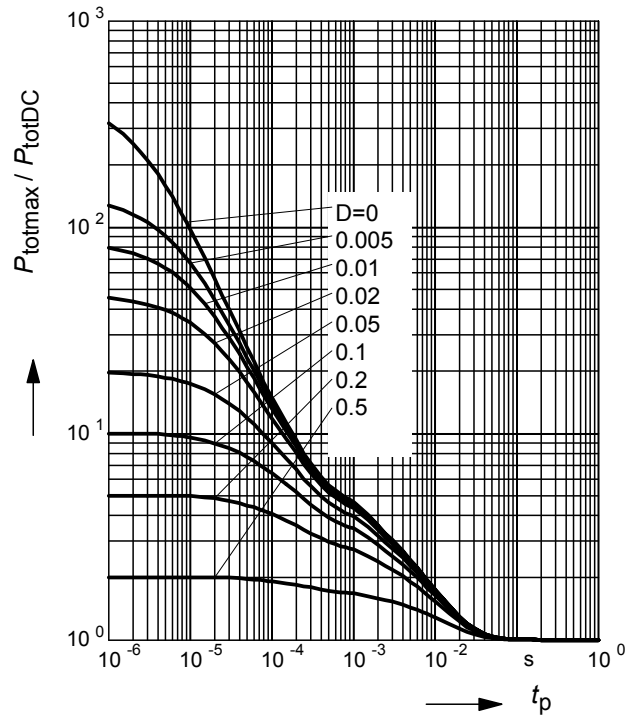

**Permissible Puls Load  $R_{thJS} = f(t_p)$**

BCR185U

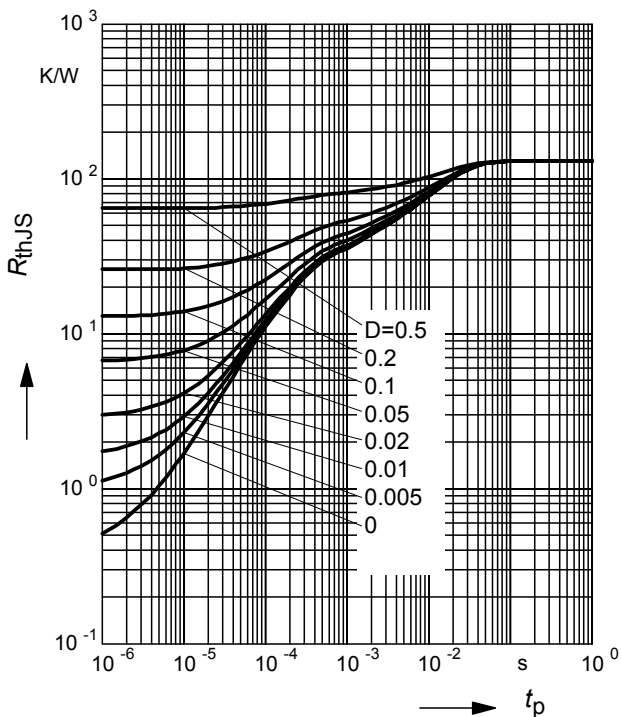

**Permissible Pulse Load**

$P_{totmax}/P_{totDC} = f(t_p)$

BCR185U

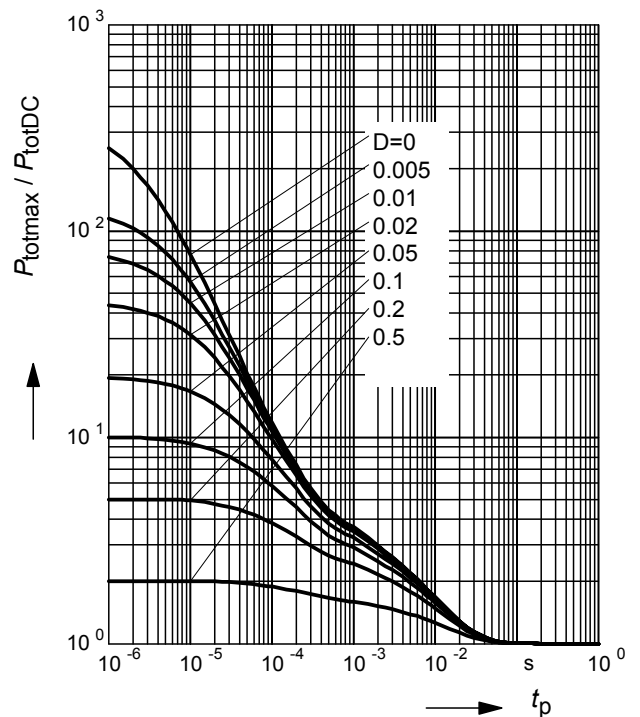

**Permissible Puls Load  $R_{thJS} = f(t_p)$**

BCR185W

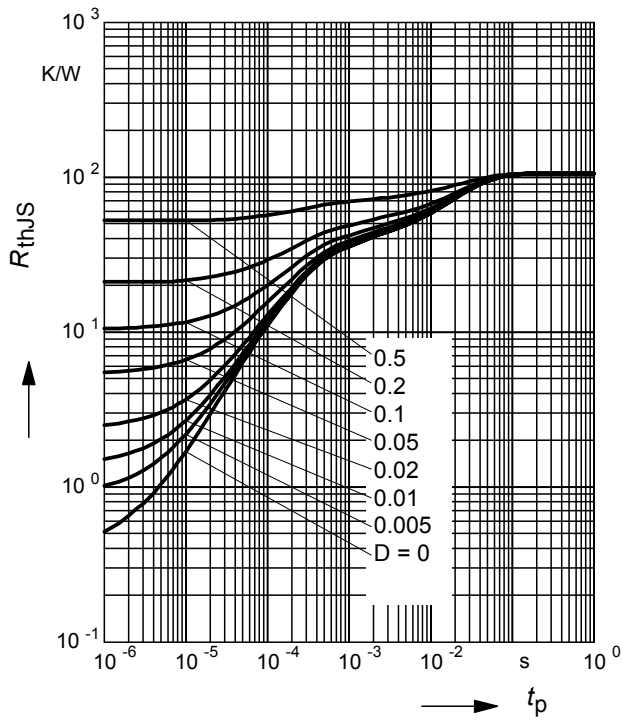

**Permissible Pulse Load**

$P_{totmax}/P_{totDC} = f(t_p)$

BCR185W

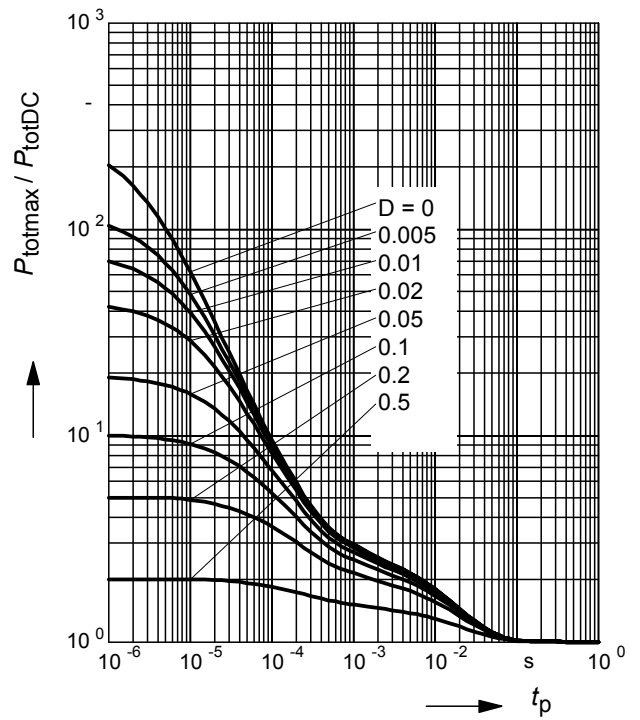

### Package Outline

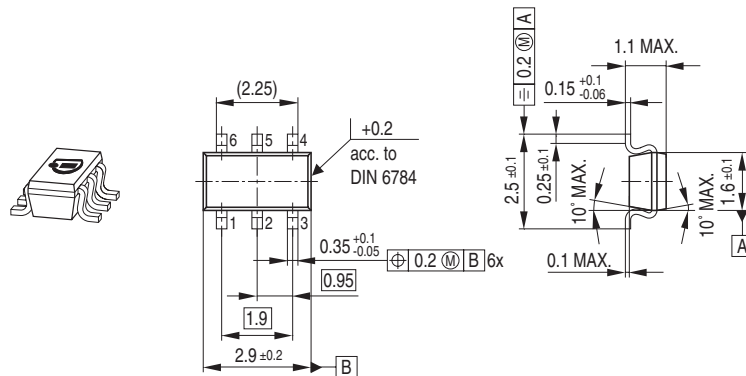

### Foot Print

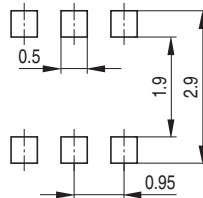

### Marking Layout

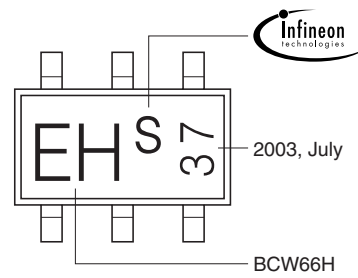
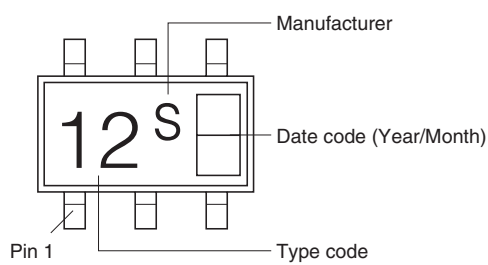

Example

### Packing

Code E6327: Reel ø180 mm = 3.000 Pieces/Reel  
 Code E6433: Reel ø330 mm = 10.000 Pieces/Reel

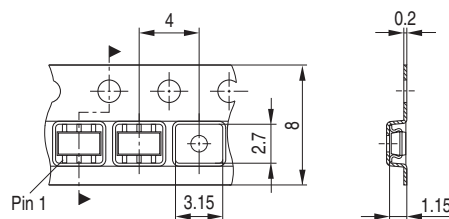

### Package Outline

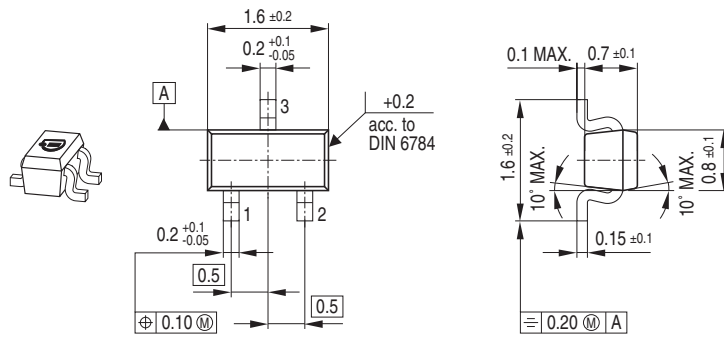

### Foot Print

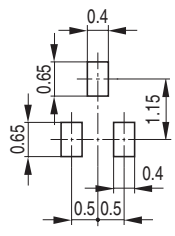

### Marking Layout

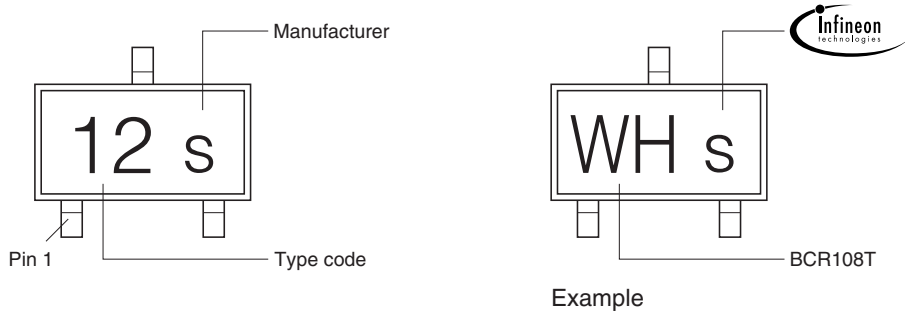

### Packing

Code E6327: Reel ø180 mm = 3.000 Pieces/Reel  
 Code E6433: Reel ø330 mm = 10.000 Pieces/Reel

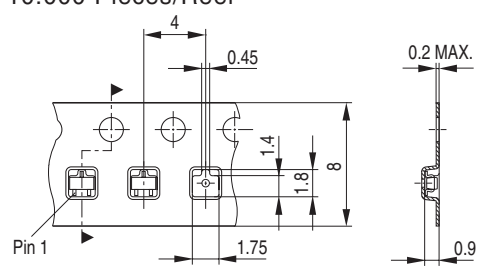

### Package Outline

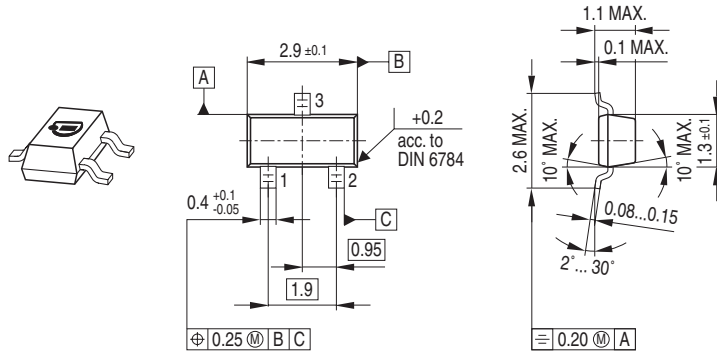

### Foot Print

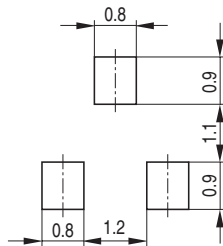

### Marking Layout

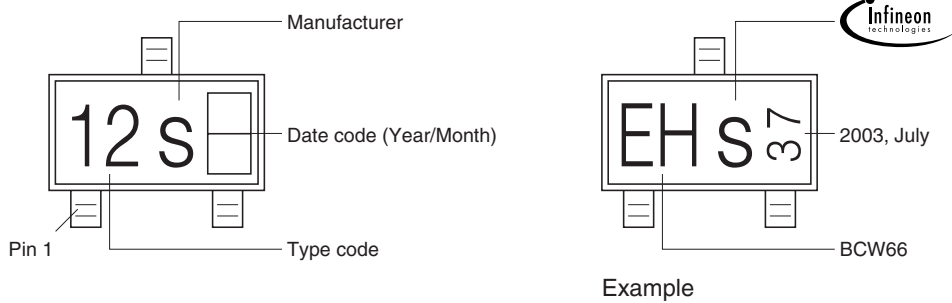

### Packing

Code E6327: Reel  $\varnothing$ 180 mm = 3.000 Pieces/Reel  
 Code E6433: Reel  $\varnothing$ 330 mm = 10.000 Pieces/Reel

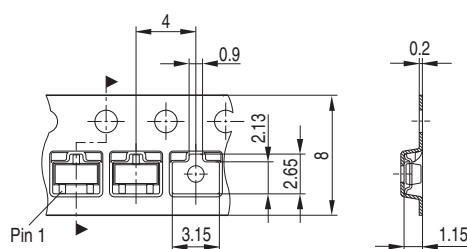

### Package Outline

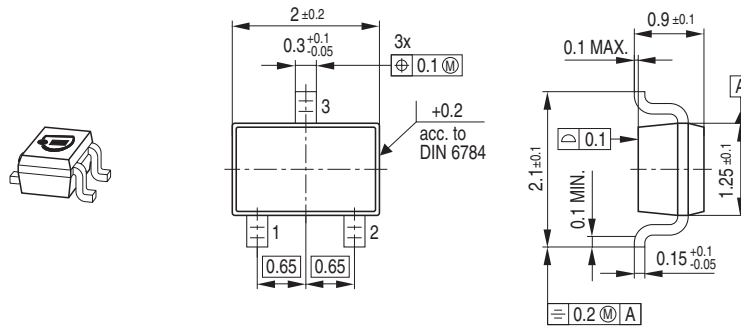

### Foot Print

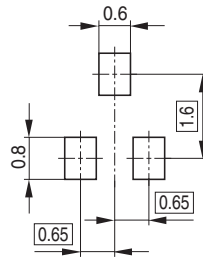

### Marking Layout

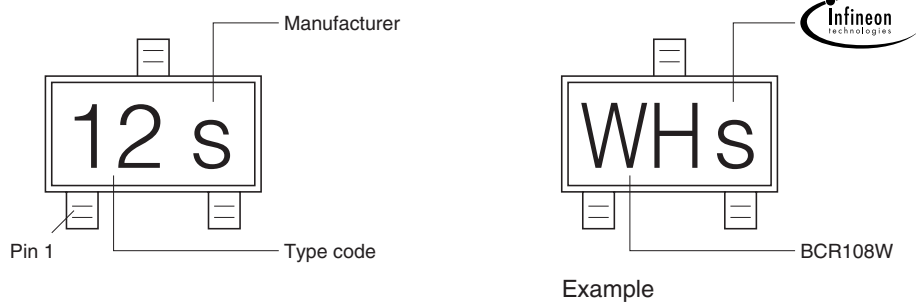

### Packing

Code E6327: Reel  $\varnothing 180$  mm = 3.000 Pieces/Reel  
 Code E6433: Reel  $\varnothing 30$  mm = 10.000 Pieces/Reel

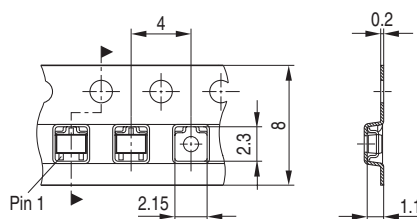

### Package Outline

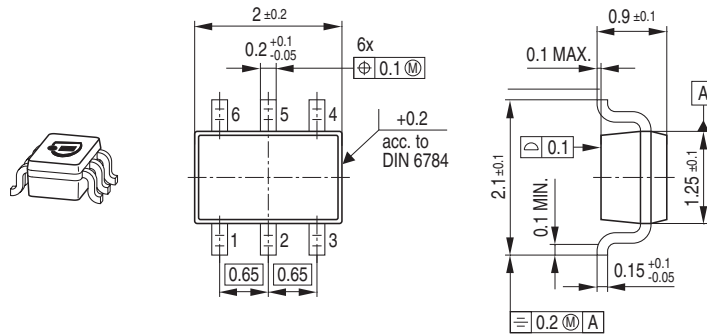

### Foot Print

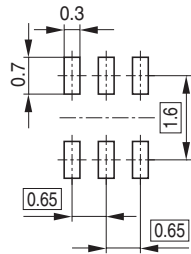

### Marking Layout

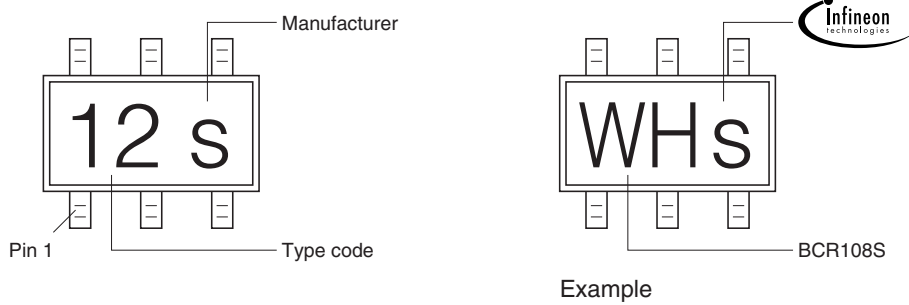

### Packing

Code E6327: Reel  $\varnothing$ 180 mm = 3.000 Pieces/Reel  
 Code E6433: Reel  $\varnothing$ 30 mm = 10.000 Pieces/Reel

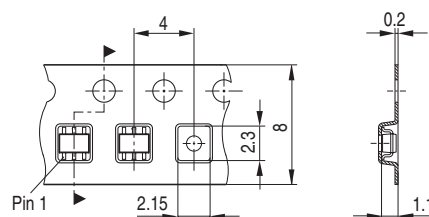



### Package Outline

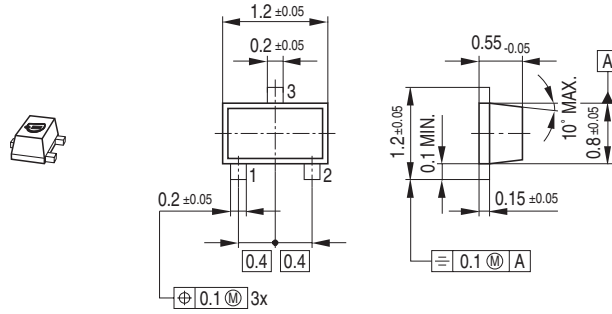

### Foot Print

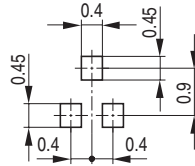

### Marking Layout

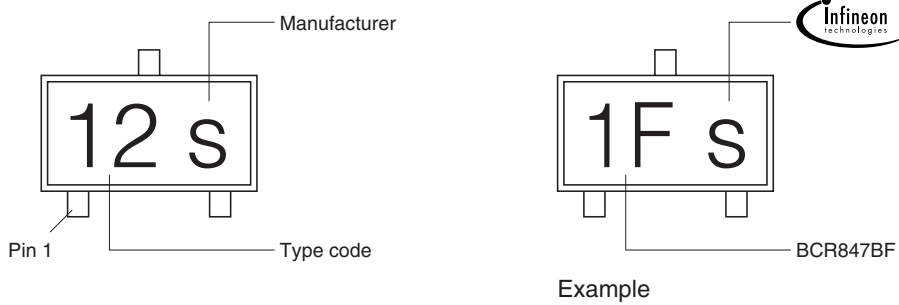

### Packing

Code E6327: Reel  $\phi 180$  mm = 3.000 Pieces/Reel  
 Code E6433: Reel  $\phi 330$  mm = 10.000 Pieces/Reel

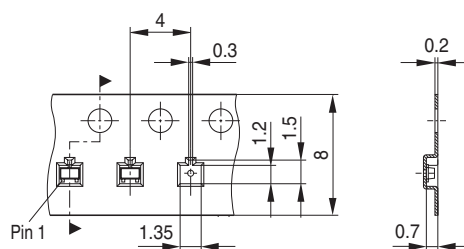

### Package Outline

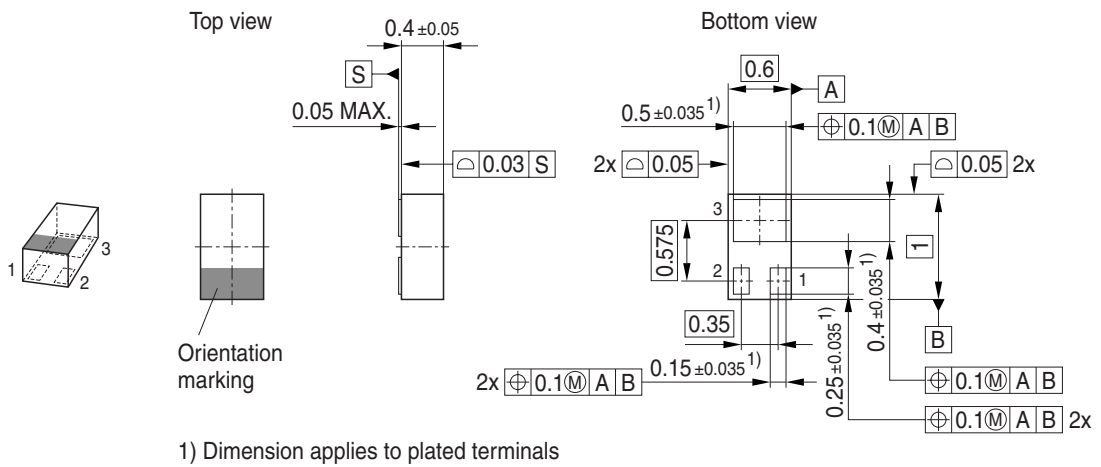

### Foot Print

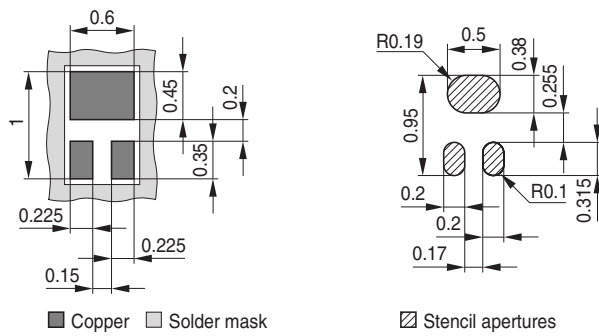

### Marking Layout

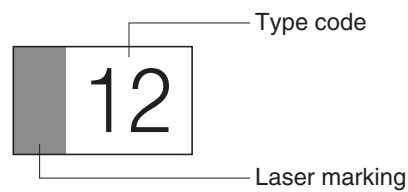

### Packing

Code E6327: Reel  $\varnothing 180$  mm = 15.000 Pieces/Reel

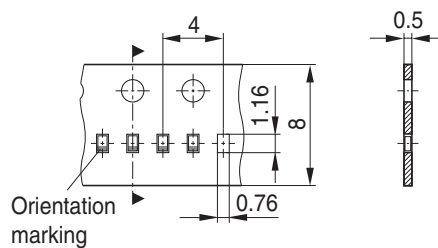

Published by Infineon Technologies AG,  
St.-Martin-Strasse 53,  
81669 München  
© Infineon Technologies AG 2005.  
All Rights Reserved.

### **Attention please!**

The information herein is given to describe certain components and shall not be considered as a guarantee of characteristics.

Terms of delivery and rights to technical change reserved.

We hereby disclaim any and all warranties, including but not limited to warranties of non-infringement, regarding circuits, descriptions and charts stated herein.

### **Information**

For further information on technology, delivery terms and conditions and prices please contact your nearest Infineon Technologies Office ([www.infineon.com](http://www.infineon.com)).

### **Warnings**

Due to technical requirements components may contain dangerous substances. For information on the types in question please contact your nearest Infineon Technologies Office.

Infineon Technologies Components may only be used in life-support devices or systems with the express written approval of Infineon Technologies, if a failure of such components can reasonably be expected to cause the failure of that life-support device or system, or to affect the safety or effectiveness of that device or system. Life support devices or systems are intended to be implanted in the human body, or to support and/or maintain and sustain and/or protect human life. If they fail, it is reasonable to assume that the health of the user or other persons may be endangered.