



Chipsmall Limited consists of a professional team with an average of over 10 year of expertise in the distribution of electronic components. Based in Hongkong, we have already established firm and mutual-benefit business relationships with customers from,Europe,America and south Asia,supplying obsolete and hard-to-find components to meet their specific needs.

With the principle of “Quality Parts,Customers Priority,Honest Operation,and Considerate Service”,our business mainly focus on the distribution of electronic components. Line cards we deal with include Microchip,ALPS,ROHM,Xilinx,Pulse,ON,Everlight and Freescale. Main products comprise IC,Modules,Potentiometer,IC Socket,Relay,Connector.Our parts cover such applications as commercial,industrial, and automotives areas.

We are looking forward to setting up business relationship with you and hope to provide you with the best service and solution. Let us make a better world for our industry!



## Contact us

Tel: +86-755-8981 8866 Fax: +86-755-8427 6832

Email & Skype: info@chipsmall.com Web: www.chipsmall.com

Address: A1208, Overseas Decoration Building, #122 Zhenhua RD., Futian, Shenzhen, China



THIS DOCUMENT IS SUBJECT TO CHANGE WITHOUT NOTICE. IT IS CONFIDENTIAL AND A PROPERTY OF Amphenol LTW. DISCLOSURE TO THIRD PARTY HAS TO BE AUTHORIZED BY Amphenol LTW.

REV.	ECN NO.	DATE	SIGN	DESCRIPTION
B	LEN14C0032	2014/11/21	Vicky	Update Logo, Dime. & Pin Assignments

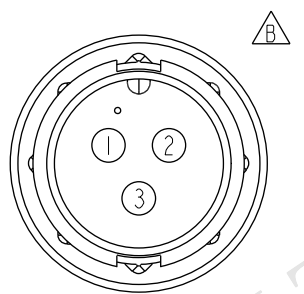
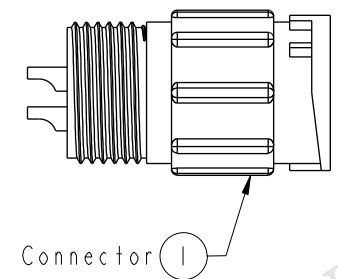
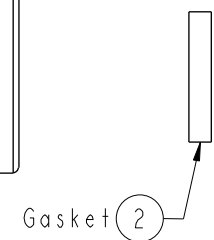
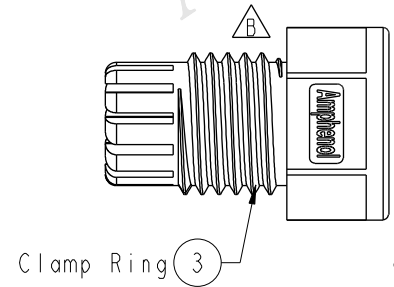
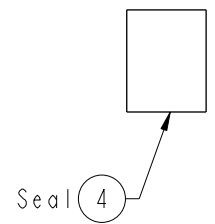
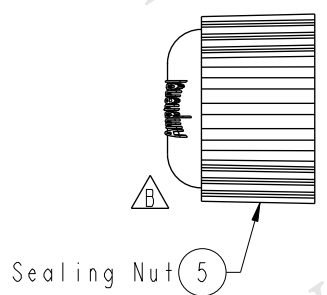
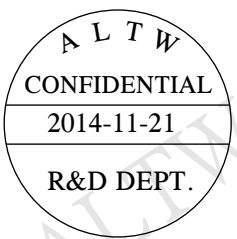

Pin Assignments  
Front View

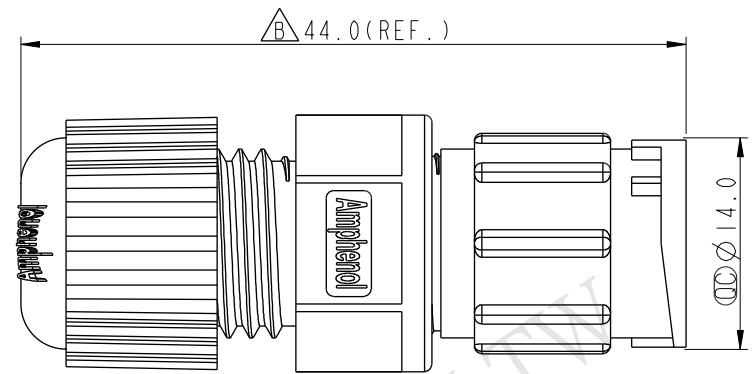

Note:

- \*  $\text{CC}$  Important Dimension To Check.
- \* Waterproof Rate: IP67
- \* Housing: Nylon+GF, Black
- \* Male Pin: Copper Alloy, Gold Plated
- \* Gasket: EPDM, Black
- \* Clamp Ring: Nylon, Black
- \* Seal: EPDM, Black
- \* Sealing Nut: Nylon, Black
- \* Seal For Cable OD:  $\varnothing 4.5\text{mm} \sim \varnothing 6.5\text{mm}$   
(防水墊圈線徑:  $\varnothing 4.5\text{mm} \sim \varnothing 6.5\text{mm}$ )
- \* One Set Unassembled In One PE Bag  
(每一組未組裝, 放置於一個PE袋, 並封口)

UNIT: mm  TOLERANCE .X ±0.25 .XX ±0.1 .XXX ±0.05 ANGLES ±1°	TITLE Standard Assy Lock 3P M Conn M Pin			<b>Amphenol LTW</b> 安費諾亮泰企業股份有限公司		ITEM NO BD-03BMMA-LL7001	DRAWN BY Vicky	DATE 2014-11-21
	SCALE 3:2	SIZE A4	SHEET 1 OF 1			DWG NO BD-03BMMA-LL7001	CHECKED BY Sam	DATE 2014-11-21
	REV. B	WC-REV. A.2	$\text{CC}$ : Inspection item	CUSTOMER ALTW	APPROVED BY Rita	DATE 2014-11-21		
								8 FMM10702-01-02A1