



Chipsmall Limited consists of a professional team with an average of over 10 year of expertise in the distribution of electronic components. Based in Hongkong, we have already established firm and mutual-benefit business relationships with customers from,Europe,America and south Asia,supplying obsolete and hard-to-find components to meet their specific needs.

With the principle of "Quality Parts,Customers Priority,Honest Operation,and Considerate Service",our business mainly focus on the distribution of electronic components. Line cards we deal with include Microchip,ALPS,ROHM,Xilinx,Pulse,ON,Everlight and Freescale. Main products comprise IC,Modules,Potentiometer,IC Socket,Relay,Connector.Our parts cover such applications as commercial,industrial, and automotives areas.

We are looking forward to setting up business relationship with you and hope to provide you with the best service and solution. Let us make a better world for our industry!



Contact us

Tel: +86-755-8981 8866 Fax: +86-755-8427 6832

Email & Skype: info@chipsmall.com Web: www.chipsmall.com

Address: A1208, Overseas Decoration Building, #122 Zhenhua RD., Futian, Shenzhen, China



REV.	ECN NO.	DATE	SIGN	DESCRIPTION

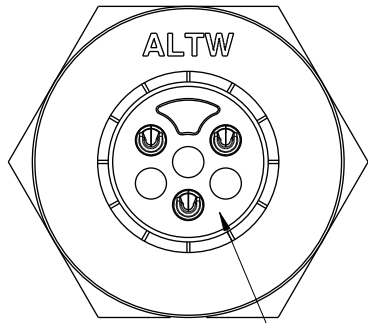

Whit Liquid Glue

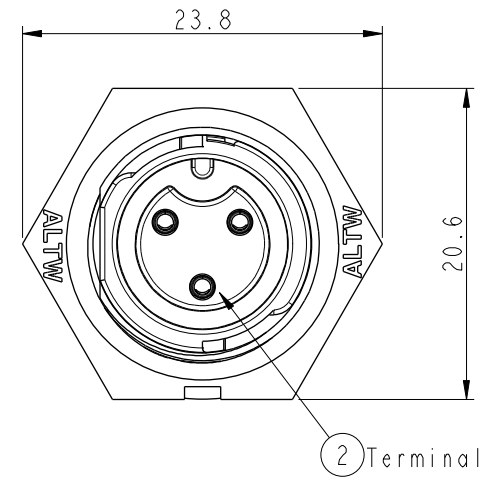
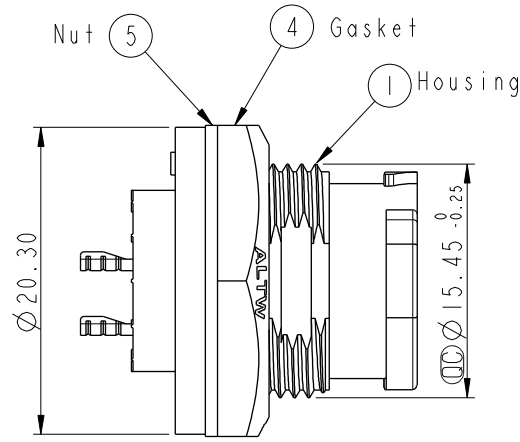

ALTW
CONFIDENTIAL
2014-10-20
R&D DEPT.

ALTW
DCC. DEPT.
CONFIDENTIAL
2014.11.26
ISSUED

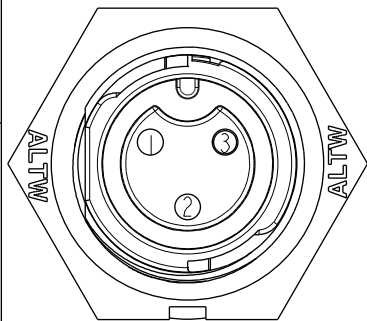

Pin Assignments
Front View

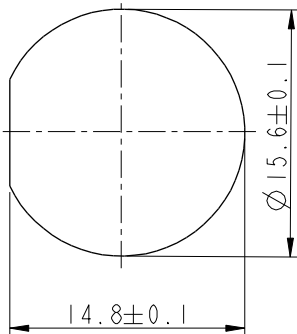

Recommended Panel Cut-out

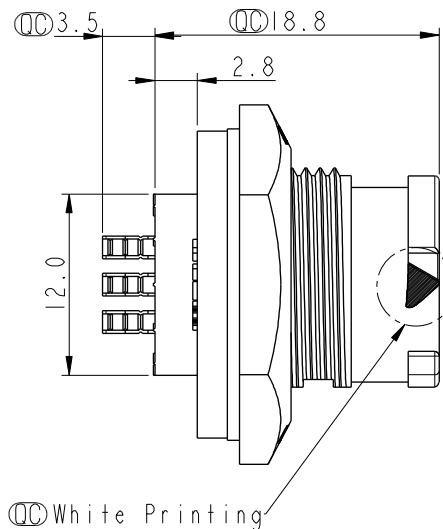

Note:

- * \varnothing Important Dimension To Check.
- * Waterproof Rate: IP68
- * Working Voltage Rating: AC 300 V
- * Working Current Rating: 5A
- * Flame Class: UL94V-0 (UV Resistance)
- * Housing: Nylon+GF, Black
- * Female Pin: Copper Alloy, Gold Plated
- * Nut: Nylon+GF, Black
- * Gasket: Silicone, Gray
- * Use Without Waterproof Cap
Panel Thickness Max: 4.0mm
- * Use With Waterproof Cap
Panel Thickness Max: 3.0mm

UNIT:mm

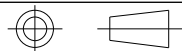

TOLERANCE
.X ±0.25

TITLE X Lok B-Size Receptacle M Conn F 3 Pin			
SCALE 2:1	SIZE A4	SHEET 1 OF 1	
REV. A	WC-REV. A.1	CC: Inspection item	

Amphenol LTW
安費諾亮泰企業股份有限公司

ITEM NO BD-03PMFS-QC8001	DRAWN BY Micky	DATE 2014-10-20
DWG NO BD-03PMFS-QC8001	CHECKED BY Spring	DATE 2014-10-20
CUSTOMER ALTW	APPROVED BY Kevin	DATE 2014-10-20

THIS DOCUMENT IS SUBJECT TO CHANGE WITHOUT NOTICE. IT IS CONFIDENTIAL AND A PROPERTY OF Amphenol LTW. DISCLOSURE TO THIRD PARTY HAS TO BE AUTHORIZED BY Amphenol LTW.