



Chipsmall Limited consists of a professional team with an average of over 10 year of expertise in the distribution of electronic components. Based in Hongkong, we have already established firm and mutual-benefit business relationships with customers from,Europe,America and south Asia,supplying obsolete and hard-to-find components to meet their specific needs.

With the principle of “Quality Parts,Customers Priority,Honest Operation,and Considerate Service”,our business mainly focus on the distribution of electronic components. Line cards we deal with include Microchip,ALPS,ROHM,Xilinx,Pulse,ON,Everlight and Freescale. Main products comprise IC,Modules,Potentiometer,IC Socket,Relay,Connector.Our parts cover such applications as commercial,industrial, and automotives areas.

We are looking forward to setting up business relationship with you and hope to provide you with the best service and solution. Let us make a better world for our industry!



Contact us

Tel: +86-755-8981 8866 Fax: +86-755-8427 6832

Email & Skype: info@chipsmall.com Web: www.chipsmall.com

Address: A1208, Overseas Decoration Building, #122 Zhenhua RD., Futian, Shenzhen, China



Xinger®

Ultra Low Profile 1608 Balun 50Ω to 50Ω Balanced

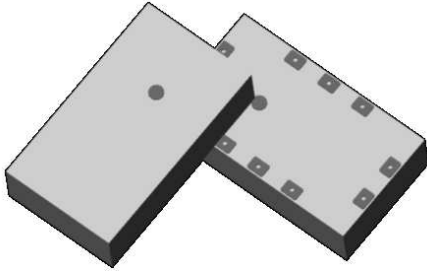

Description

The BD0205F5050AHF is a low profile sub-miniature balanced to unbalanced transformer designed for differential input locations on data conversion devices such as A to D and D to A converters. In an easy to use surface mount package covering 75 MHz to 1000 MHz and with CMRR performances over 2x that of the incumbent wire wound products, this transformer is optimized to offer improved SFDR management during operation of the data converter device. The BD0205F5050AHF is ideal for high volume manufacturing and is higher performance and smaller form factor than traditional wire wound transformers. The BD0205F5050AHF has an unbalanced port impedance of 50Ω and a 50Ω balanced port impedance. This transformation enables single ended signals to be applied to differential ports on the data converter devices. The output ports have equal amplitude (-3dB) with 180 degree phase differential. The BD0205F5050AHF is available on tape and reel for pick and place high volume manufacturing.

Detailed Electrical Specifications: Specifications subject to change without notice.

Features:	Parameter	ROOM (25°C)						Unit
		Min.	Typ.	Max	Min.	Typ.	Max	
• 70 – 1000 MHz (IL 3dB BW)	Frequency	70		1000	200		500	MHz
• 200-500 MHz (IL 1dB BW)	Unbalanced Port Impedance		50			50		Ohm
• 0.83 mm Height Profile	Balanced Port Impedance		50			50		Ohm
• 50 Ohm to 2 x 25 Ohm	Return Loss	4	4.6		11	13		dB
• Excellent CMRR (36dB typical)	Insertion Loss*		3.0	3.4		0.9	1.1	dB
• Input to Output DC Isolation	Amplitude Balance		0.2	0.6		0.2	0.6	dB
• Surface Mountable	Phase Balance		1	3		1	3	Degrees
• Tape & Reel	CMRR		36			36		dB
• Non-conductive Top Surface	Power Handling			2			2	Watts
• RoHS Compliant	Operating Temperature	-55		+85	-55		+85	°C
• Halogen Free								

* Insertion Loss stated at room temperature (Insertion Loss is approximately 0.1 dB higher at +85 °C)

Outline Drawing

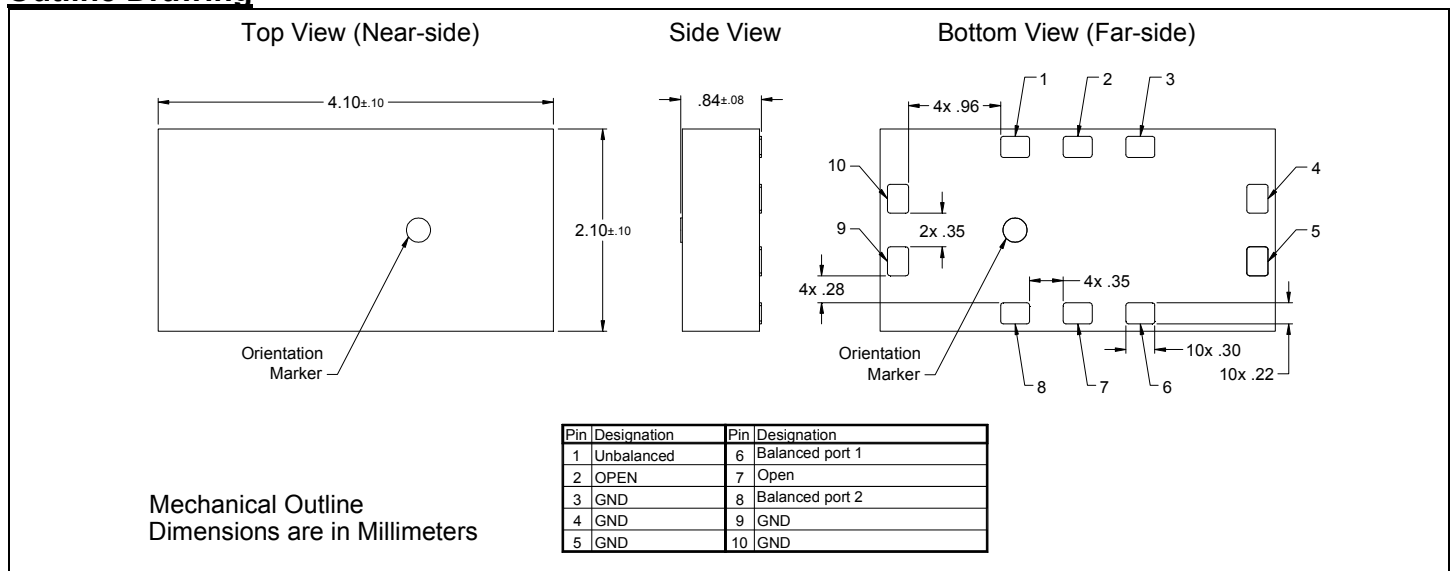

Typical Broadband Performance: 0 - 8.0 GHz.

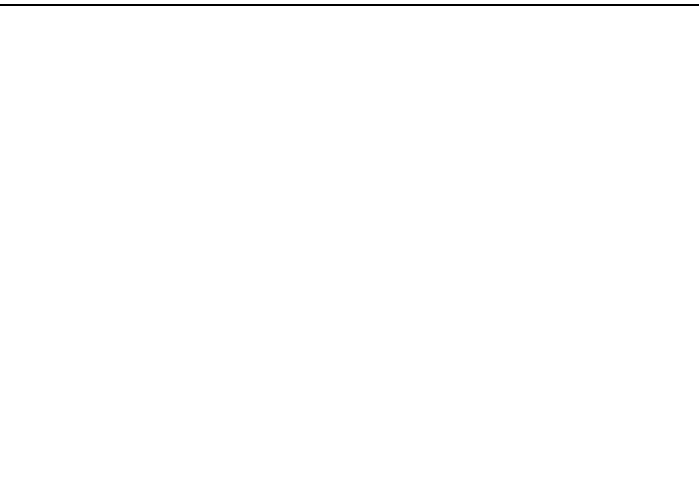
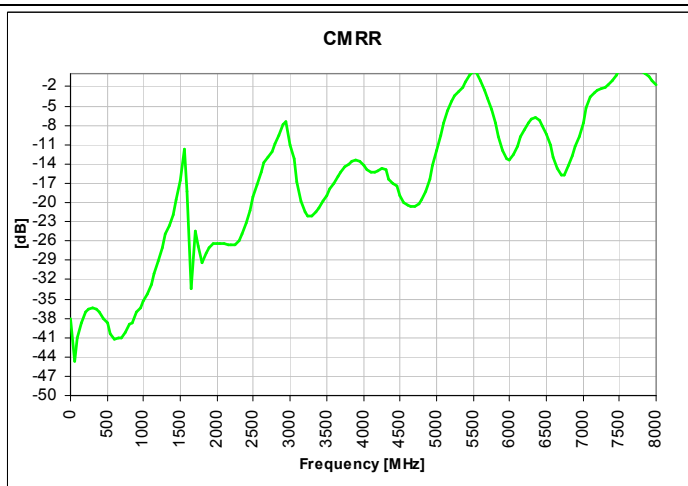
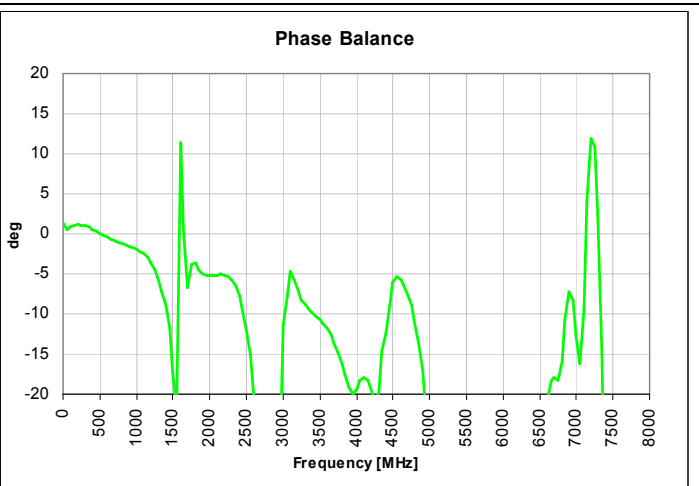
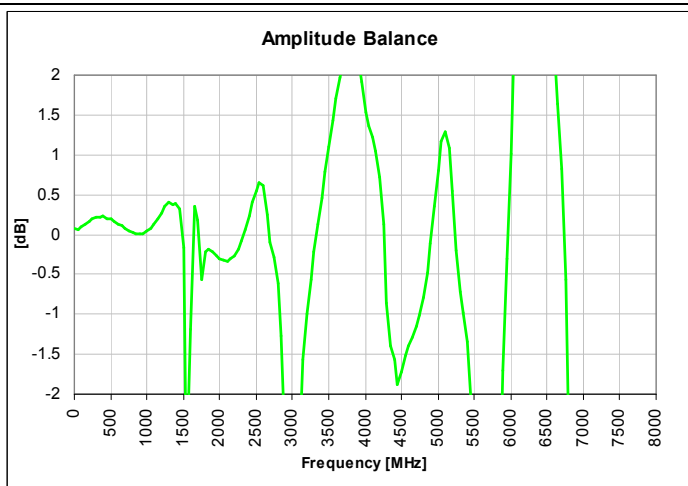
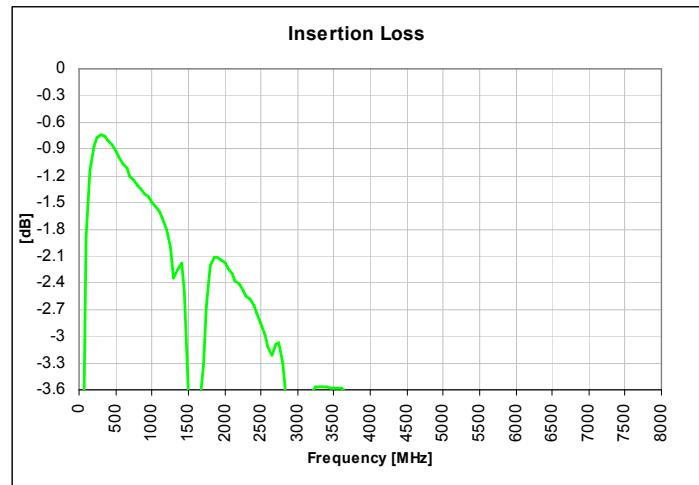
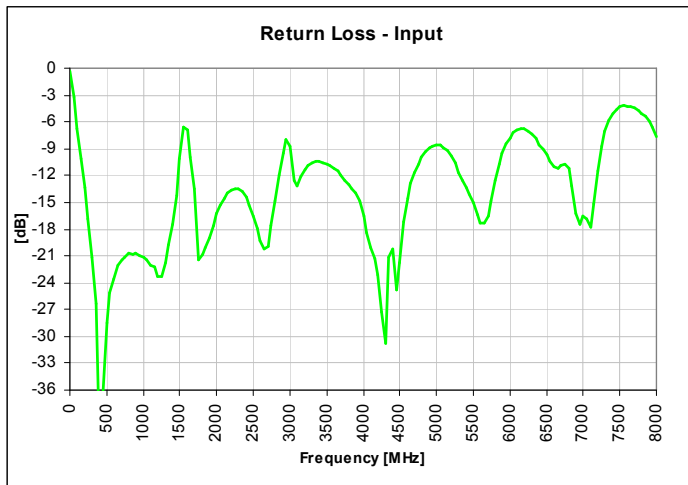

Typical Performance: 0 MHz. to 1000 MHz.

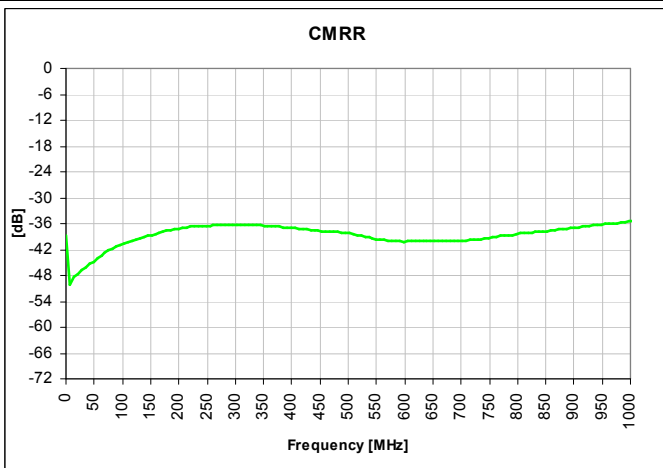
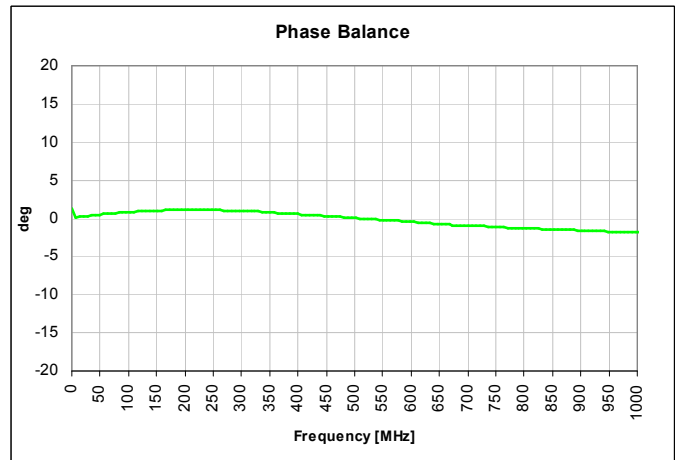
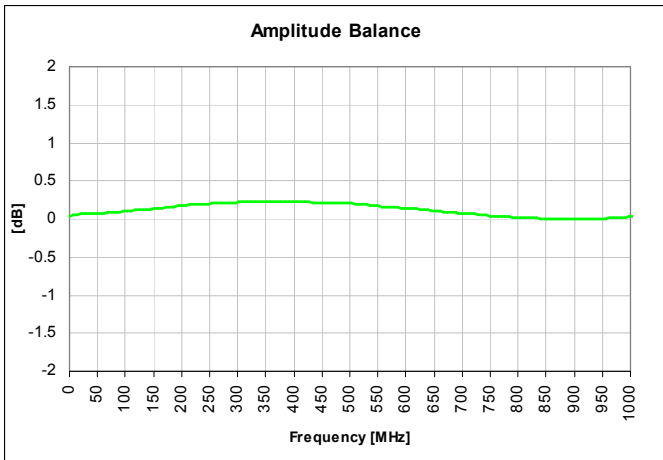
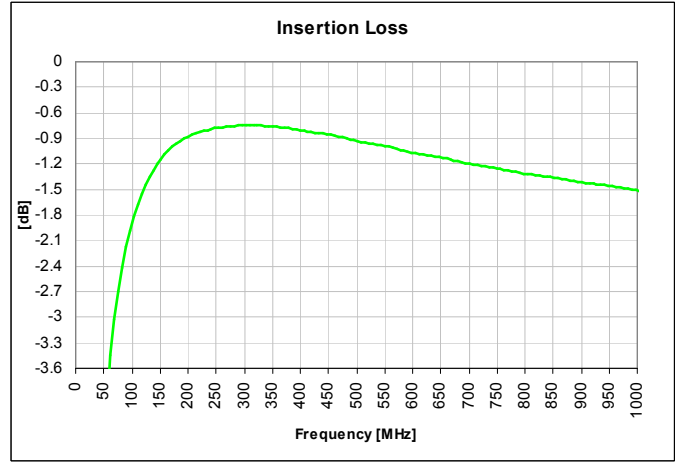
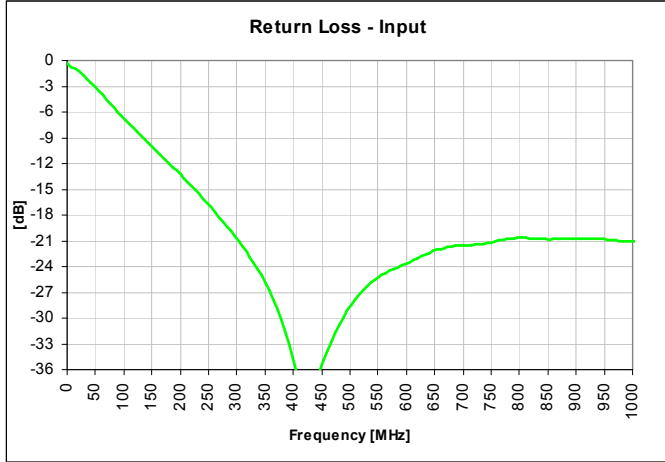

Application in ADC Frontend:

Modern Analog-to-Digital Converter (ADC) system often uses differential architecture to suppress the even-order harmonics. The performance of ADC system is heavily influenced by amplitude and phase imbalances arising from the ADC frontend, especially in high frequency applications. Anaren's multi-layer balun BD0205F5050AHF offers superb amplitude and phase balance performance over wide frequency range, translating to excellent SFDR performance of the ADC system. BD0205F5050AHF is a ferrite free design eliminating related inter-modulation and other non-linear effects. BD0205F5050AHF provides wideband impedance match, resulting in improvement of gain flatness at high frequencies, which in turn reduces input drive requirement. Anaren's highly repeatable manufacturing process results in little part to part variation, ensuring consistent performance in production.

The schematic of a typical ADC front end application is shown below. In conjunction with many high speed ADC ICs, a bandwidth of 70MHz to 250MHz can be obtained for -1dB ripple of gain flatness. Differential load R1 and R2 are 33 ohm, slightly higher than the theoretical 25 ohm, to increase the voltage gain and reduce the required input drive, while keeping acceptable return loss. Optional series resistors, R5, R6, R7 and R8 are used to limit the amount of charge injection from the unbuffered ADC back into the analog input. Optional RC circuits, R3, R4, C4 and C5 further improve SDFR in many circumstances by supplying an additional current path to neutralize the charge injection.

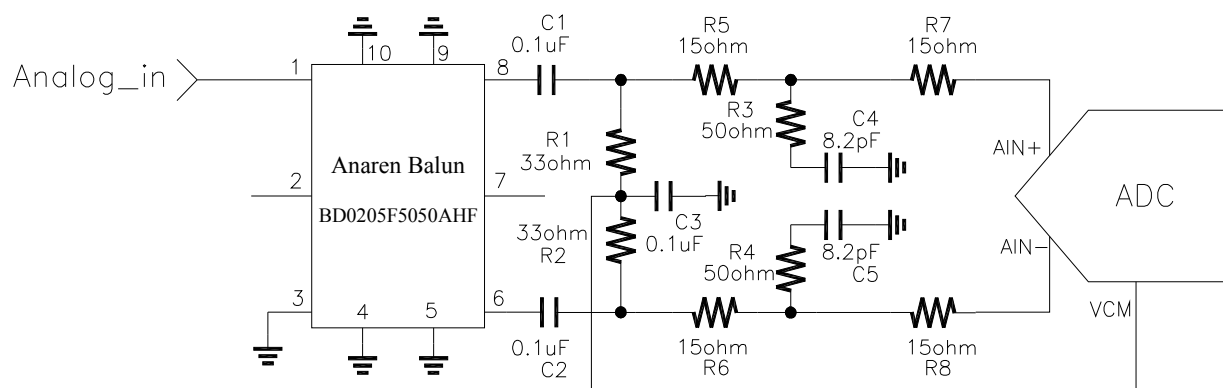

Typical ADC frontend schematic using BD0205F5050AHF

Mounting Configuration:

In order for Xinger surface mount components to work optimally, the proper impedance transmission lines must be used to connect to the RF ports. If this condition is not satisfied, insertion loss, Isolation and VSWR may not meet published specifications.

All of the Xinger components are constructed from organic PTFE based composites which possess excellent electrical and mechanical stability. Xinger components are compliant to a variety of ROHS and Green standards and ready for Pb-free soldering processes. Pads are Gold plated with a Nickel barrier.

An example of the PCB footprint used in the testing of these parts is shown below. In specific designs, the transmission line widths need to be adjusted to the unique dielectric coefficients and thicknesses as well as varying pick and place equipment tolerances.

