



Chipsmall Limited consists of a professional team with an average of over 10 year of expertise in the distribution of electronic components. Based in Hongkong, we have already established firm and mutual-benefit business relationships with customers from,Europe,America and south Asia,supplying obsolete and hard-to-find components to meet their specific needs.

With the principle of “Quality Parts,Customers Priority,Honest Operation,and Considerate Service”,our business mainly focus on the distribution of electronic components. Line cards we deal with include Microchip,ALPS,ROHM,Xilinx,Pulse,ON,Everlight and Freescale. Main products comprise IC,Modules,Potentiometer,IC Socket,Relay,Connector.Our parts cover such applications as commercial,industrial, and automotives areas.

We are looking forward to setting up business relationship with you and hope to provide you with the best service and solution. Let us make a better world for our industry!



Contact us

Tel: +86-755-8981 8866 Fax: +86-755-8427 6832

Email & Skype: info@chipsmall.com Web: www.chipsmall.com

Address: A1208, Overseas Decoration Building, #122 Zhenhua RD., Futian, Shenzhen, China



BD135G, BD137G, BD139G

Plastic Medium-Power Silicon NPN Transistors

This series of plastic, medium-power silicon NPN transistors are designed for use as audio amplifiers and drivers utilizing complementary or quasi complementary circuits.

Features

- High DC Current Gain
- BD 135, 137, 139 are complementary with BD 136, 138, 140
- These Devices are Pb-Free, Halogen Free/BFR Free and are RoHS Compliant*

MAXIMUM RATINGS

Rating	Symbol	Value	Unit
Collector-Emitter Voltage BD135G BD137G BD139G	V_{CEO}	45 60 80	Vdc
Collector-Base Voltage BD135G BD137G BD139G	V_{CBO}	45 60 100	Vdc
Emitter-Base Voltage	V_{EBO}	5.0	Vdc
Collector Current	I_C	1.5	Adc
Base Current	I_B	0.5	Adc
Total Device Dissipation @ $T_A = 25^\circ\text{C}$ Derate above 25°C	P_D	1.25 10	Watts mW/ $^\circ\text{C}$
Total Device Dissipation @ $T_C = 25^\circ\text{C}$ Derate above 25°C	P_D	12.5 100	Watts mW/ $^\circ\text{C}$
Operating and Storage Junction Temperature Range	T_J, T_{stg}	-55 to +150	$^\circ\text{C}$

Stresses exceeding those listed in the Maximum Ratings table may damage the device. If any of these limits are exceeded, device functionality should not be assumed, damage may occur and reliability may be affected.

THERMAL CHARACTERISTICS

Characteristic	Symbol	Max	Unit
Thermal Resistance, Junction-to-Case	$R_{\theta JC}$	10	$^\circ\text{C/W}$
Thermal Resistance, Junction-to-Ambient	$R_{\theta JA}$	100	$^\circ\text{C/W}$

*For additional information on our Pb-Free strategy and soldering details, please download the ON Semiconductor Soldering and Mounting Techniques Reference Manual, SOLDERRM/D.



ON Semiconductor®

<http://onsemi.com>

1.5 A POWER TRANSISTORS NPN SILICON 45, 60, 80 V, 12.5 W

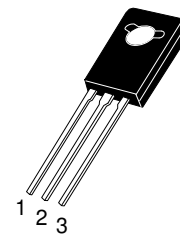
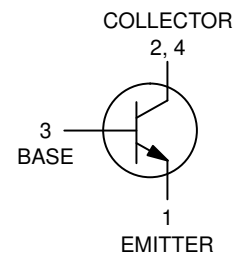

TO-225
CASE 77-09
STYLE 1

MARKING DIAGRAM

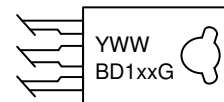

Y = Year
 WW = Work Week
 BD1xx = Device Code
 xx = 35, 37, 39
 G = Pb-Free Package

ORDERING INFORMATION

Device	Package	Shipping
BD135G	TO-225 (Pb-Free)	500 Units / Box
BD135TG	TO-225 (Pb-Free)	50 Units / Rail
BD137G	TO-225 (Pb-Free)	500 Units / Box
BD139G	TO-225 (Pb-Free)	500 Units / Box

BD135G, BD137G, BD139G

ELECTRICAL CHARACTERISTICS ($T_C = 25^\circ\text{C}$ unless otherwise noted)

Characteristic	Symbol	Min	Max	Unit
Collector–Emitter Sustaining Voltage* ($I_C = 0.03\text{ A}$, $I_B = 0$) BD135G BD137G BD139G	BV_{CEO}^*	45 60 80	– – –	Vdc
Collector Cutoff Current ($V_{CB} = 30\text{ Vdc}$, $I_E = 0$) ($V_{CB} = 30\text{ Vdc}$, $I_E = 0$, $T_C = 125^\circ\text{C}$)	I_{CBO}	– –	0.1 10	μA dc
Emitter Cutoff Current ($V_{BE} = 5.0\text{ Vdc}$, $I_C = 0$)	I_{EBO}	–	10	μA dc
DC Current Gain ($I_C = 0.005\text{ A}$, $V_{CE} = 2\text{ V}$) ($I_C = 0.15\text{ A}$, $V_{CE} = 2\text{ V}$) ($I_C = 0.5\text{ A}$, $V_{CE} = 2\text{ V}$)	h_{FE}^*	25 40 25	– 250 –	–
Collector–Emitter Saturation Voltage* ($I_C = 0.5\text{ A}$, $I_B = 0.05\text{ A}$)	$V_{CE(sat)}^*$	–	0.5	Vdc
Base–Emitter On Voltage* ($I_C = 0.5\text{ A}$, $V_{CE} = 2.0\text{ Vdc}$)	$V_{BE(on)}^*$	–	1	Vdc

Product parametric performance is indicated in the Electrical Characteristics for the listed test conditions, unless otherwise noted. Product performance may not be indicated by the Electrical Characteristics if operated under different conditions.

*Pulse Test: Pulse Width $\leq 300\ \mu\text{s}$, Duty Cycle $\leq 2.0\%$.

TYPICAL CHARACTERISTICS

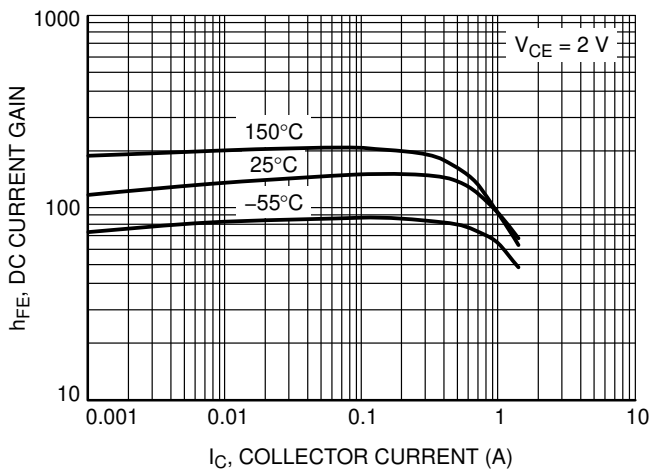

Figure 1. DC Current Gain

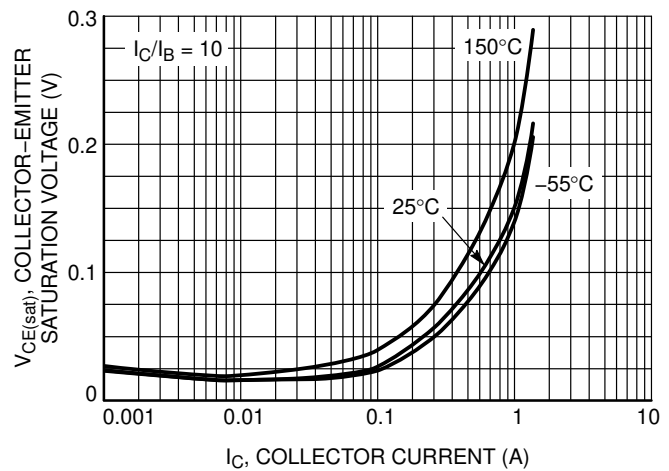

Figure 2. Collector–Emitter Saturation Voltage

BD135G, BD137G, BD139G

TYPICAL CHARACTERISTICS

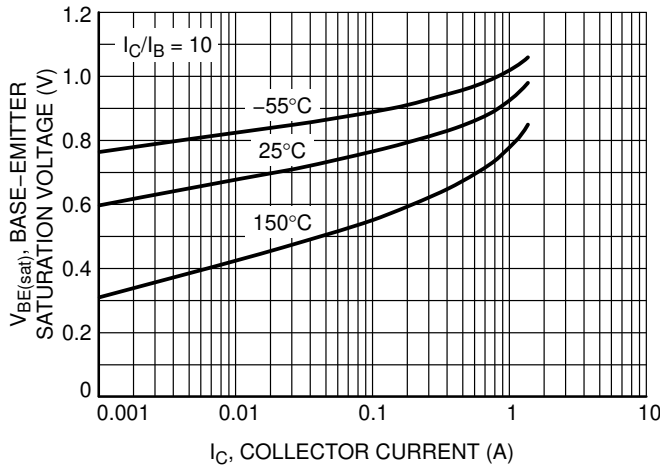

Figure 3. Base-Emitter Saturation Voltage

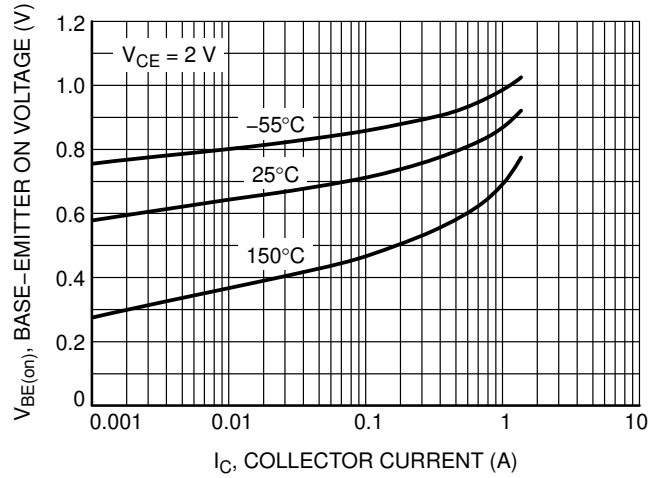

Figure 4. Base-Emitter On Voltage

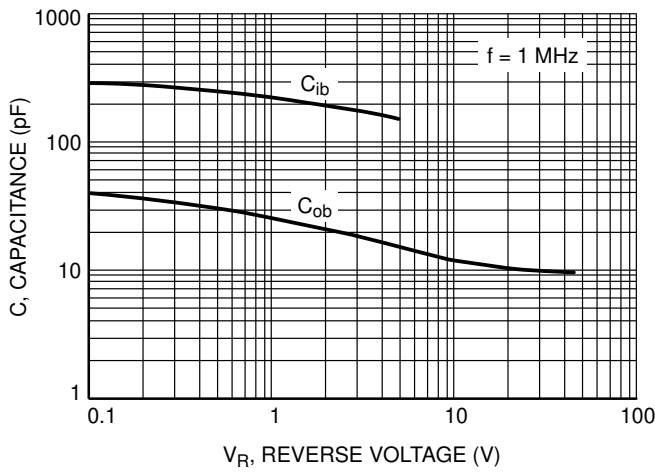

Figure 5. Capacitance

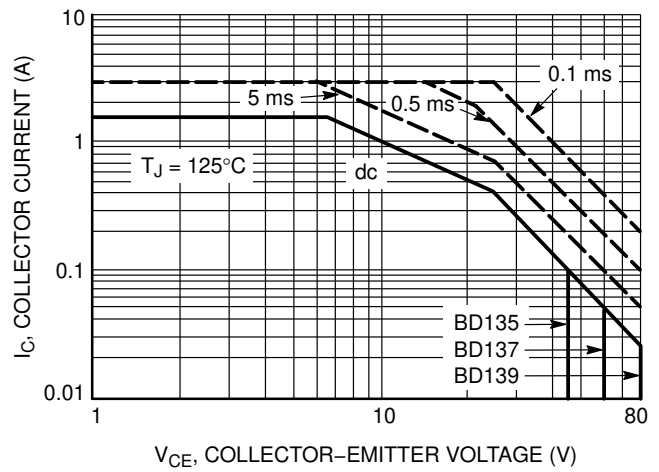

Figure 6. Active-Region Safe Operating Area

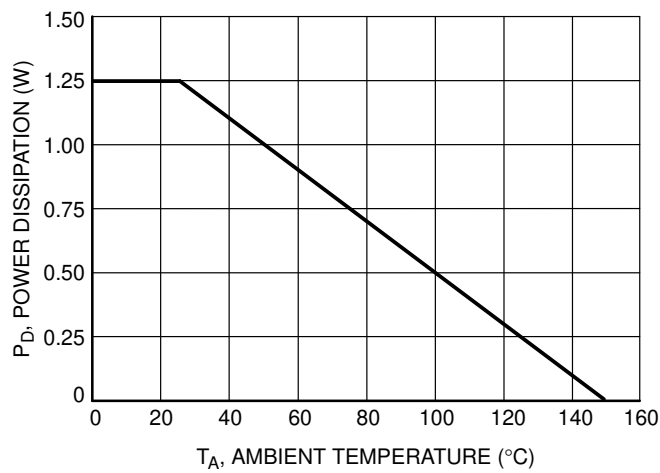
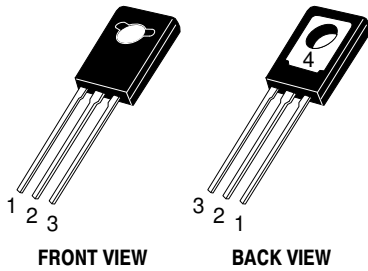

Figure 7. Power Derating

BD135G, BD137G, BD139G

PACKAGE DIMENSIONS



TO-225
CASE 77-09
ISSUE AC

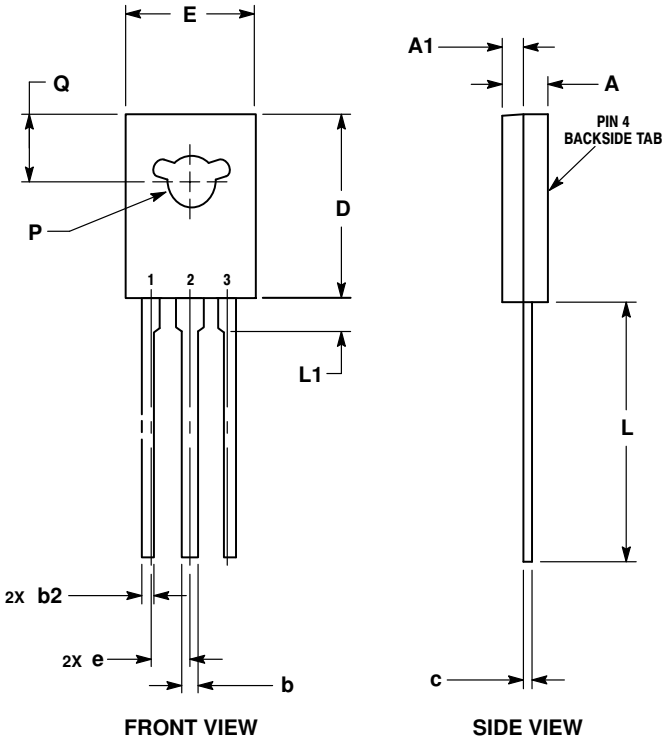

- NOTES:
1. DIMENSIONING AND TOLERANCING PER ASME Y14.5M, 1994.
 2. CONTROLLING DIMENSION: MILLIMETERS.
 3. NUMBER AND SHAPE OF LUGS OPTIONAL.

DIM	MILLIMETERS	
	MIN	MAX
A	2.40	3.00
A1	1.00	1.50
b	0.60	0.90
b2	0.51	0.88
c	0.39	0.63
D	10.60	11.10
E	7.40	7.80
e	2.04	2.54
L	14.50	16.63
L1	1.27	2.54
P	2.90	3.30
Q	3.80	4.20

- STYLE 1:
PIN 1. EMITTER
2., 4. COLLECTOR
3. BASE

ON Semiconductor and are registered trademarks of Semiconductor Components Industries, LLC (SCILLC). SCILLC owns the rights to a number of patents, trademarks, copyrights, trade secrets, and other intellectual property. A listing of SCILLC's product/patent coverage may be accessed at www.onsemi.com/site/pdf/Patent-Marking.pdf. SCILLC reserves the right to make changes without further notice to any products herein. SCILLC makes no warranty, representation or guarantee regarding the suitability of its products for any particular purpose, nor does SCILLC assume any liability arising out of the application or use of any product or circuit, and specifically disclaims any and all liability, including without limitation special, consequential or incidental damages. "Typical" parameters which may be provided in SCILLC data sheets and/or specifications can and do vary in different applications and actual performance may vary over time. All operating parameters, including "Typicals" must be validated for each customer application by customer's technical experts. SCILLC does not convey any license under its patent rights nor the rights of others. SCILLC products are not designed, intended, or authorized for use as components in systems intended for surgical implant into the body, or other applications intended to support or sustain life, or for any other application in which the failure of the SCILLC product could create a situation where personal injury or death may occur. Should Buyer purchase or use SCILLC products for any such unintended or unauthorized application, Buyer shall indemnify and hold SCILLC and its officers, employees, subsidiaries, affiliates, and distributors harmless against all claims, costs, damages, and expenses, and reasonable attorney fees arising out of, directly or indirectly, any claim of personal injury or death associated with such unintended or unauthorized use, even if such claim alleges that SCILLC was negligent regarding the design or manufacture of the part. SCILLC is an Equal Opportunity/Affirmative Action Employer. This literature is subject to all applicable copyright laws and is not for resale in any manner.

PUBLICATION ORDERING INFORMATION

LITERATURE FULFILLMENT:

Literature Distribution Center for ON Semiconductor
P.O. Box 5163, Denver, Colorado 80217 USA
Phone: 303-675-2175 or 800-344-3860 Toll Free USA/Canada
Fax: 303-675-2176 or 800-344-3867 Toll Free USA/Canada
Email: orderlit@onsemi.com

N. American Technical Support: 800-282-9855 Toll Free
USA/Canada
Europe, Middle East and Africa Technical Support:
Phone: 421 33 790 2910
Japan Customer Focus Center
Phone: 81-3-5817-1050

ON Semiconductor Website: www.onsemi.com

Order Literature: <http://www.onsemi.com/orderlit>

For additional information, please contact your local Sales Representative