



Chipsmall Limited consists of a professional team with an average of over 10 year of expertise in the distribution of electronic components. Based in Hongkong, we have already established firm and mutual-benefit business relationships with customers from,Europe,America and south Asia,supplying obsolete and hard-to-find components to meet their specific needs.

With the principle of “Quality Parts,Customers Priority,Honest Operation,and Considerate Service”,our business mainly focus on the distribution of electronic components. Line cards we deal with include Microchip,ALPS,ROHM,Xilinx,Pulse,ON,Everlight and Freescale. Main products comprise IC,Modules,Potentiometer,IC Socket,Relay,Connector.Our parts cover such applications as commercial,industrial, and automotives areas.

We are looking forward to setting up business relationship with you and hope to provide you with the best service and solution. Let us make a better world for our industry!



Contact us

Tel: +86-755-8981 8866 Fax: +86-755-8427 6832

Email & Skype: info@chipsmall.com Web: www.chipsmall.com

Address: A1208, Overseas Decoration Building, #122 Zhenhua RD., Futian, Shenzhen, China





The BF Series Paddle is the very latest generation in high precision contactless controls. It combines the features of a contactless single axis joystick and a switch in one control. Long trouble-free life is assured with the latest Hall effect technology, providing a range of analog, switched or custom PWM output options. The all-new design with its innovative mechanism and ergonomic styling is specifically designed for robustness, strength and performance.



KEY FEATURES

- Hall effect joystick and switch function
- Sculpted ergonomic design
- Next generation Hall effect technology
- 5V operation - dual redundant outputs as standard
- Two lever height variants
- Industry standard connector
- IP67 sealed
- Sprung and detent lever options
- Available with color-coded inserts
- EMC & Magnetically shielded - analog or PWM outputs
- Effectively zero below panel depth
- End stackable mounting



BF series

Paddle controllers

OPTION SELECTION

<table border="1"> <thead> <tr> <th colspan="2">PADDLE</th> </tr> </thead> <tbody> <tr> <td>BF</td> <td>74mm (2.91in) above the panel</td> </tr> <tr> <td>BD</td> <td>50mm (1.97in) above the panel</td> </tr> </tbody> </table>	PADDLE		BF	74mm (2.91in) above the panel	BD	50mm (1.97in) above the panel	<table border="1"> <thead> <tr> <th colspan="2">GAIN</th> </tr> </thead> <tbody> <tr> <td>10</td> <td>+/-10% x V</td> </tr> <tr> <td>25</td> <td>+/-25% x V</td> </tr> <tr> <td>30</td> <td>+/-30% x V</td> </tr> <tr> <td>40</td> <td>+/-40% x V</td> </tr> <tr> <td>50</td> <td>+/-50% x V</td> </tr> </tbody> </table>	GAIN		10	+/-10% x V	25	+/-25% x V	30	+/-30% x V	40	+/-40% x V	50	+/-50% x V	<table border="1"> <thead> <tr> <th colspan="2">INSERT COLOR</th> </tr> </thead> <tbody> <tr> <td>BK</td> <td>Black</td> </tr> <tr> <td>RE</td> <td>Red</td> </tr> <tr> <td>BL</td> <td>Blue</td> </tr> <tr> <td>YE</td> <td>Yellow</td> </tr> <tr> <td>GR</td> <td>Green</td> </tr> </tbody> </table>	INSERT COLOR		BK	Black	RE	Red	BL	Blue	YE	Yellow	GR	Green	<table border="1"> <thead> <tr> <th colspan="2">MODIFIER</th> </tr> </thead> <tbody> <tr> <td>00</td> <td>None</td> </tr> </tbody> </table>	MODIFIER		00	None			
PADDLE																																								
BF	74mm (2.91in) above the panel																																							
BD	50mm (1.97in) above the panel																																							
GAIN																																								
10	+/-10% x V																																							
25	+/-25% x V																																							
30	+/-30% x V																																							
40	+/-40% x V																																							
50	+/-50% x V																																							
INSERT COLOR																																								
BK	Black																																							
RE	Red																																							
BL	Blue																																							
YE	Yellow																																							
GR	Green																																							
MODIFIER																																								
00	None																																							
<table border="1"> <thead> <tr> <th colspan="2">CONFIGURATION</th> </tr> </thead> <tbody> <tr> <td>1</td> <td>Standard Dual Outputs</td> </tr> <tr> <td>2</td> <td>Inverse Dual Outputs</td> </tr> <tr> <td>3</td> <td>PWM</td> </tr> </tbody> </table>	CONFIGURATION		1	Standard Dual Outputs	2	Inverse Dual Outputs	3	PWM	<table border="1"> <thead> <tr> <th colspan="2">LEVER OPERATION</th> </tr> </thead> <tbody> <tr> <td>A01</td> <td>Sprung to Center</td> </tr> <tr> <td>D01</td> <td>Center Detent</td> </tr> <tr> <td>D02</td> <td>12.5 Degree Detents</td> </tr> <tr> <td>D03</td> <td>12.5 & 25 Degree Detents</td> </tr> <tr> <td>D04</td> <td>25 Degree Detents</td> </tr> <tr> <td>SD1</td> <td>Sprung to Center with D1</td> </tr> <tr> <td>SD2</td> <td>Sprung to Center with D2</td> </tr> <tr> <td>SD3</td> <td>Sprung to Center with D3</td> </tr> <tr> <td>SD4</td> <td>Sprung to Center with D4</td> </tr> </tbody> </table>	LEVER OPERATION		A01	Sprung to Center	D01	Center Detent	D02	12.5 Degree Detents	D03	12.5 & 25 Degree Detents	D04	25 Degree Detents	SD1	Sprung to Center with D1	SD2	Sprung to Center with D2	SD3	Sprung to Center with D3	SD4	Sprung to Center with D4	<table border="1"> <thead> <tr> <th colspan="2">SWITCHING POINTS</th> </tr> </thead> <tbody> <tr> <td>00</td> <td>No Switches</td> </tr> <tr> <td>05</td> <td>+/- 5 Degrees</td> </tr> <tr> <td>12</td> <td>+/- 12.5 Degrees</td> </tr> <tr> <td>25</td> <td>+/- 25 Degrees</td> </tr> </tbody> </table>	SWITCHING POINTS		00	No Switches	05	+/- 5 Degrees	12	+/- 12.5 Degrees	25	+/- 25 Degrees
CONFIGURATION																																								
1	Standard Dual Outputs																																							
2	Inverse Dual Outputs																																							
3	PWM																																							
LEVER OPERATION																																								
A01	Sprung to Center																																							
D01	Center Detent																																							
D02	12.5 Degree Detents																																							
D03	12.5 & 25 Degree Detents																																							
D04	25 Degree Detents																																							
SD1	Sprung to Center with D1																																							
SD2	Sprung to Center with D2																																							
SD3	Sprung to Center with D3																																							
SD4	Sprung to Center with D4																																							
SWITCHING POINTS																																								
00	No Switches																																							
05	+/- 5 Degrees																																							
12	+/- 12.5 Degrees																																							
25	+/- 25 Degrees																																							

LEVER OPERATION

DETENT OPTIONS

D01 = CENTER DETENT

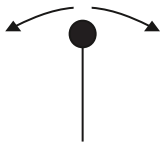

D02 = +/-12.5 DEGREES

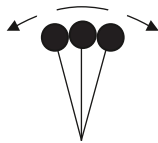

D03 = +/- 12.5 & 25 DEGREES

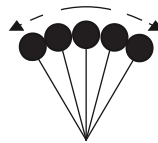

D04 = +/-25 DEGREES

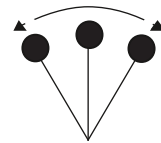

SPRUNG TO CENTER WITH DETENT OPTIONS

SD1 = CENTER DETENT

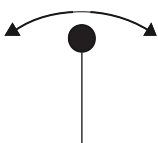

SD2 = +/-12.5 DEGREES

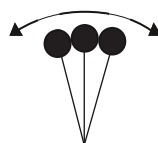

SD3 = +/- 12.5 & 25 DEGREES

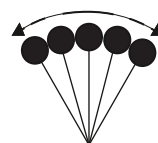

SD4 = +/- 25 DEGREES

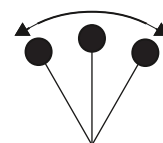

BF series

Paddle controllers

SPECIFICATIONS

MECHANICAL

Materials Employed	-	Polyetherimide, Polycarbonate, Stainless Steel
Weight	-	50g
Mechanical Operating Angle	-	+/- 25 Degrees
Max Load to Mechanism	-	Vertical: IK08 (BSEN62262:2002) Horizontal: 75N (16.86lbf)

ELECTRICAL

Gain (Output Voltage Span)	-	+/- 10% x V to +/- 50% x V
Output at Center	-	V/2 +/- (5% x Gain)
Power Supply	-	5V +/- 0.5V Transient free
Switch Outputs	-	Open Drain, pulled high within control via 1K5 to 5V, and smoothed to 0V with 100nF
Sensor Type	-	Hall effect
Current Consumption	-	<20mA
Loads	-	Minimum 10K, preferred 100K+

ENVIRONMENTAL

Storage	-	-40°C to 70°C (-40°F to 158°F)
Operating Temperature	-	-25°C to 70°C (-13°F to 158°F)
Seal Above Panel	-	IP67 (Gasket fitted as standard)
EMC Emissions	-	Complies with EN 61000-6-3:2001 CISPR 22:2005 Class B 30MHz - 11GHz
Life Cycles	-	5 million cycles sprung version only. Detents rated to 2 million cycles
ESD	-	Complies with EN61000-4-2 (extended) +/- 8KV (20 contacts) & +/- 15KV (20 air discharges)
EMC Immunity	-	100V/m, 80MHz-2.7GHz, 1KHz 80% sine wave modulation, EN 61000-4-3 (extended)
Vibration	-	100Hz - 200Hz @ 0.13g ² /Hz, total 3.6gRMS (1 Hour in each of the three mutually perpendicular axes)

All parameters shown are based on a standard configuration and are provided for guidance only. Please refer to Apem for assistance on how to achieve the best performance from your chosen configuration.



BF series

Paddle controllers

DIMENSIONAL DRAWINGS

GENERAL DIMENSIONS

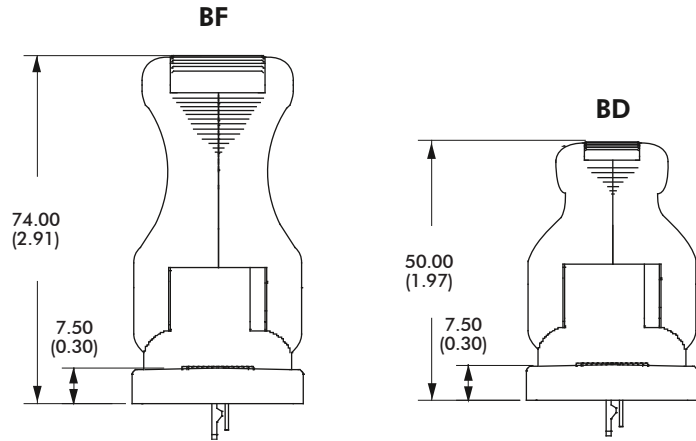
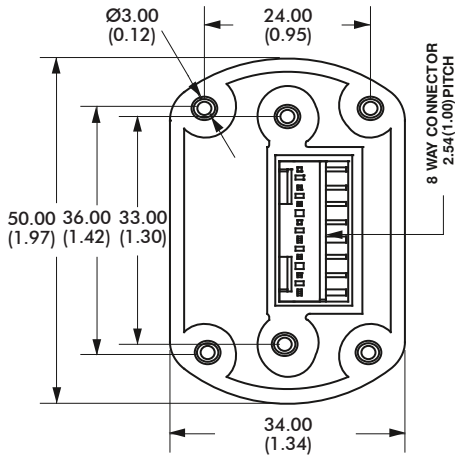

DROP IN MOUNTING - PANEL CUT-OUT & MOUNTING INSTALLATION

The Paddle may be mounted with two different hole patterns:

- Two screws - in line on the Y axis (shown as yellow screws)
- Four screws - one in each corner (shown as silver screws)

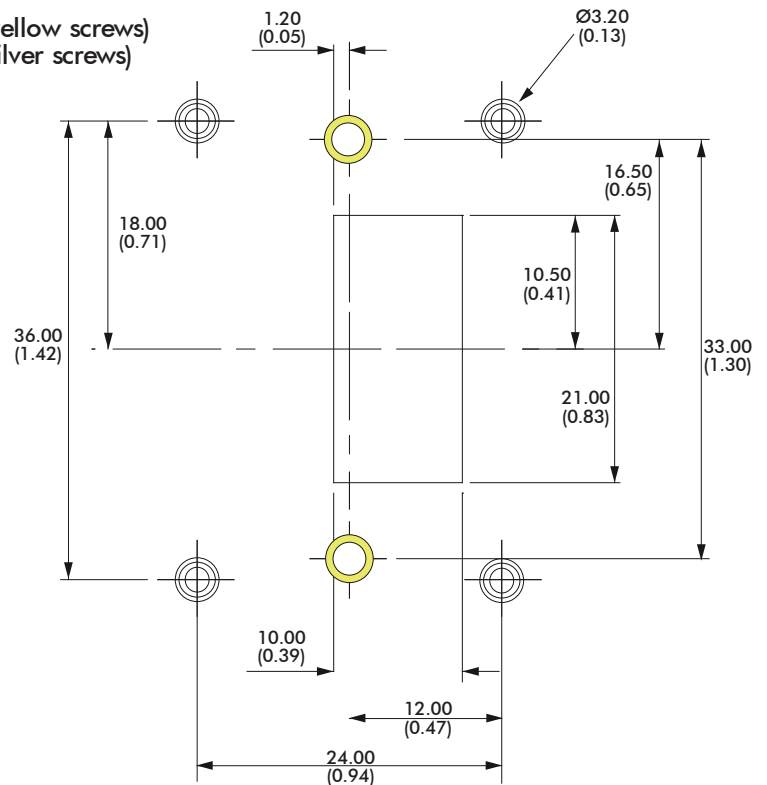

The Paddle is fitted with M3 bushes in all six positions, as standard.
Fasteners are not supplied as standard. The appropriate length of fastener is dependent on panel thickness.

NOTE: All dimensions in mm/(inch).

BF series

Paddle controllers

MECHANICAL & CONNECTION INFORMATION

MECHANISM

The brand new mechanism design has been developed for strength and long life while retaining a superb feel.

SPRUNG TO CENTER

The lever springs back to the center position when released.

DETENT POSITIONS

The lever 'clicks' into a number of preset positions. The internal switches can be configured to trigger at two of these points

DETENT POSITIONS WITH SPRUNG TO CENTER

The lever 'clicks' into a number of preset positions and springs back to its center position when released.

CONNECTIONS

The Paddle is fitted, as standard, with an industry standard 2.54mm pitch 8 way connector.

CONNECTIONS

Paddles are supplied with an eight way connector as standard.

- PIN 1: 5V
- PIN 2: Switch 1(+)
- PIN 3: 0V
- PIN 4: Analog/PWM output 1
- PIN 5: Analog/PWM output 2
- PIN 6: 0V
- PIN 7: Switch 2 (-)
- PIN 8: 5V

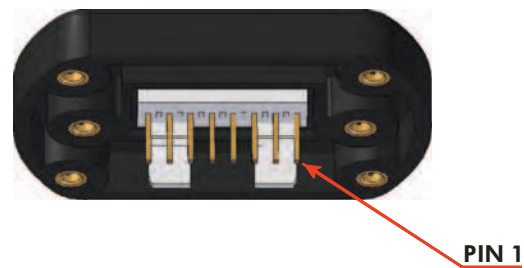

BF SERIES OUTPUT CHARACTERISTICS - 40% GAIN DUAL INVERSE OUTPUTS

Switches at 12.5 Degrees

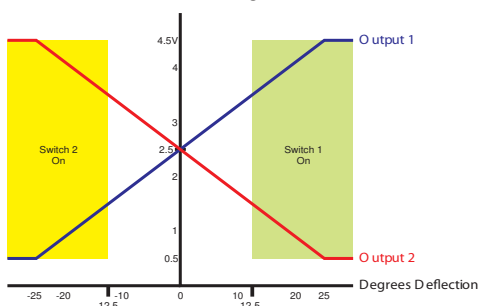

Switches at 25 Degrees

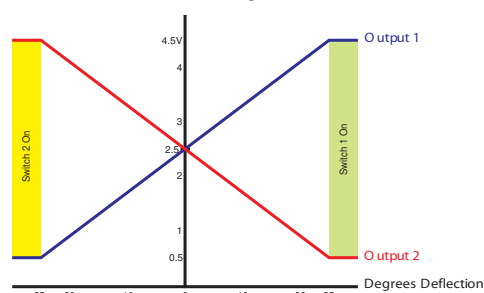

40% GAIN DUAL OUTPUTS

Switches at 12.5 Degrees

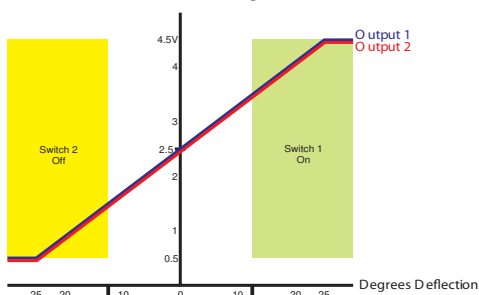

Switches at 25 Degrees

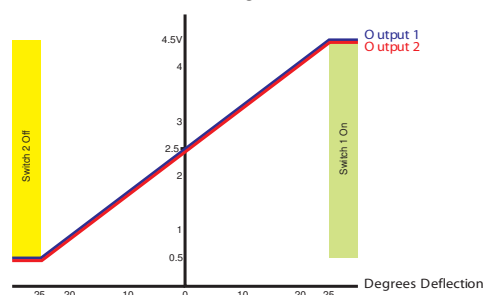

Equivalent circuit for the switch output

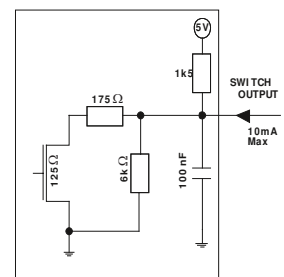

Note: When Dual Output (non-inverted) option is selected the polarity of Switch 2 is inverted

Note: The company reserves the right to change specifications without notice.

BF series

Paddle controllers

CONFIGURATION OPTIONS

OUTPUT OPTIONS

The BF Series Paddle is configured as two "electrical" controls in one mechanical package. The Paddle operates from 5V and provides two proportional outputs. The second output is accurate to the first within +/-3% of the power supply. The power supply for the secondary output is also completely independent. Customers may choose their preference of voltage outputs (gains).

The secondary output can be of the same or inverse polarity to the primary wiper. For example, with a secondary inverse output, the first and second outputs can be summed and compared to zero to verify that the joystick is operating correctly. Paddles having two identical outputs of the same polarity may be used to drive two identical dual redundant circuits.

There are also two Hall effect switches that trigger at pre-determined lever positions.

The BF Series Paddle may be specified with a variety of PWM output options. For more details on available PWM options please refer to Apem.

ADDITIONAL OUTPUT INFORMATION

SELECTABLE SWITCHING POINTS

The Paddle incorporates two Hall effect switches. The angle of the lever at the switch trigger point can be selected when ordering.

If no switches are specified then the output on pins 2 and 7 will be unused.

The outputs are configured as 'open drain' type with a 1K5 pull up resistor to 5V.

GAIN OPTIONS

The voltage output on the wiper, at full scale deflection is determined by the gain. The gain is expressed as a percentage of the voltage supplied. Therefore (assuming a 5V supply) a Paddle specified with +/- 25% gain would yield 1.25V at South, 2.5V at center and 3.75V at North. A range of gain options are available as standard. All controls are supplied pre-set and no further calibration is needed throughout the lifetime of operation.

OUTPUT IMPEDANCE

The voltage outputs at center and at each end of travel are specified across an infinite load, with no current flowing. The output impedance specified in the electrical specification should be taken into account when designing a system. Load resistance of less than 10K Ohms is not recommended.

HANDLE OPTIONS

The BF Series offers two standard handle options. The taller (74mm) handle provides the most ergonomic solution while the shorter (50mm) is best suited to hand held applications where a minimized height is preferred. The taller lever is supplied with the top insert prefitted, however the shorter lever may be specified with no insert fitted and the snap in inserts supplied loose for ease of customer integration.

BF series

Paddle controllers

APPLICATION DETAILS

LINEAR OUTPUT OPTIONS

DUAL OUTPUT - CONFIGURATION 3

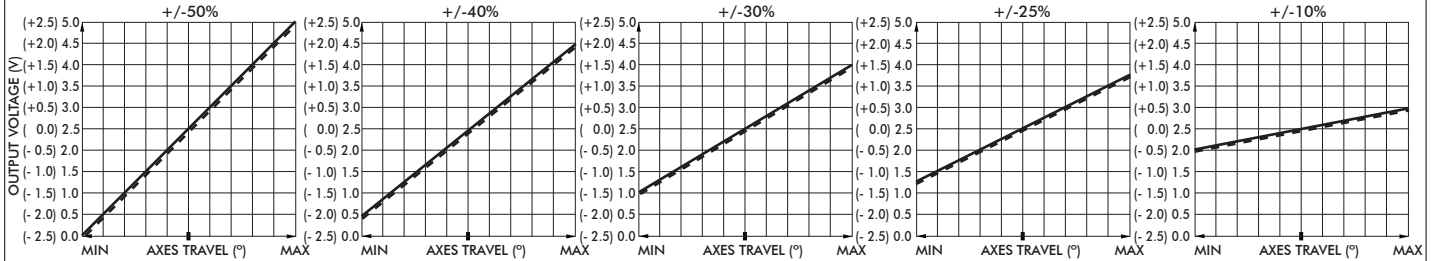

DUAL OUTPUT - CONFIGURATION 4

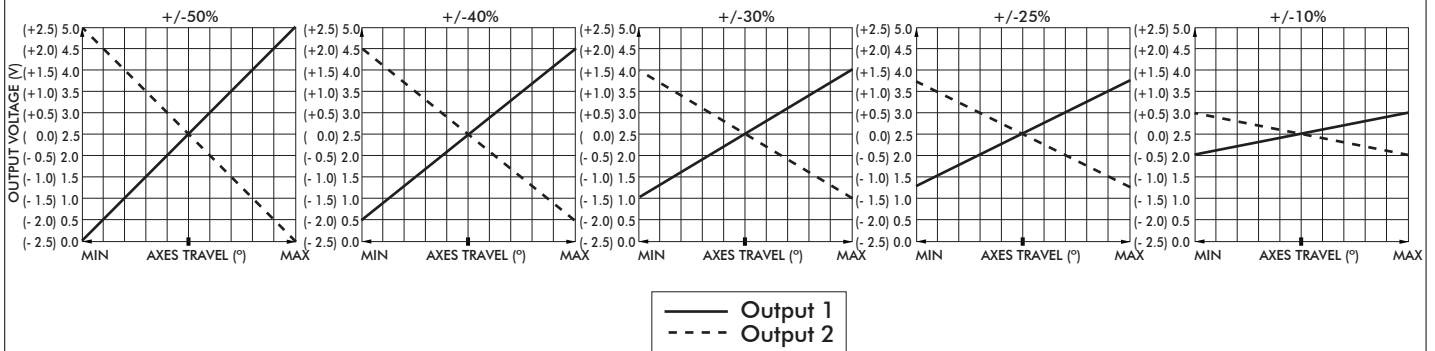

POWER SUPPLY

The BF Series is designed to be powered by a regulated 5V +/- 0.5V power supply. The outputs are ratiometric, making a stable, noise free, power supply essential. The power supply to the joystick should be carefully regulated to be within tolerance. Should the power supply change outside of the specified tolerances, permanent damage may occur.

MAGNETIC IMMUNITY AND SYSTEM DESIGN

The BF Series incorporates internal magnetic screening to minimize the effect of external magnetic fields. Mounting or operating the Paddle close to strong magnetic fields is not recommended. System designers should follow best practice when incorporating the BF Series Paddle into their products. Care should be taken to decouple the power supply properly and to employ adequate EMC shielding.

MOUNTING

When mounting the Paddle, care should be taken to site it in a position that does not make it vulnerable to damage when in use. If the Paddle is intended for use in a handheld enclosure then care must be taken to protect the Paddle from damage caused by dropping. Basic precautions such as mounting it at the lightest end of the enclosure so it doesn't hit the ground first or by protecting it with a guard should always be implemented for long term reliability. The body of the Paddle, on the underside of the panel, must not be subject to water spray, excessive humidity or dust.



Note: The company reserves the right to change specifications without notice.