



Chipsmall Limited consists of a professional team with an average of over 10 year of expertise in the distribution of electronic components. Based in Hongkong, we have already established firm and mutual-benefit business relationships with customers from,Europe,America and south Asia,supplying obsolete and hard-to-find components to meet their specific needs.

With the principle of “Quality Parts,Customers Priority,Honest Operation,and Considerate Service”,our business mainly focus on the distribution of electronic components. Line cards we deal with include Microchip,ALPS,ROHM,Xilinx,Pulse,ON,Everlight and Freescale. Main products comprise IC,Modules,Potentiometer,IC Socket,Relay,Connector.Our parts cover such applications as commercial,industrial, and automotives areas.

We are looking forward to setting up business relationship with you and hope to provide you with the best service and solution. Let us make a better world for our industry!



## Contact us

Tel: +86-755-8981 8866 Fax: +86-755-8427 6832

Email & Skype: info@chipsmall.com Web: www.chipsmall.com

Address: A1208, Overseas Decoration Building, #122 Zhenhua RD., Futian, Shenzhen, China



# High Side Switch ICs 1ch

**BD2045AFJ BD2055AFJ**

## ●General Description

Single channel high side switch IC for USB port is a high side switch having over current protection used in power supply line of universal serial bus (USB). N-channel power MOSFET with low on resistance and low supply current are realized in this IC. Over current detection circuit, thermal shutdown circuit, under voltage lockout and soft start circuit are built in.

## ●Features

- Low on resistance 80mΩ Nch MOSFET Switch.
- Continuous current load 0.25A
- Control input logic
  - Active-Low : BD2045AFJ
  - Active-High: BD2055AFJ
- Soft start circuit
- Over current detection
- Thermal shutdown
- Under voltage lockout
- Open drain error flag output
- Reverse-current protection when power switch off
- TTL Enable input
- 1.2ms typical rise time

## ●Applications

USB hub in consumer appliances, Car accessory, PC, PC peripheral equipment, and so forth

## ●Typical Application Circuit

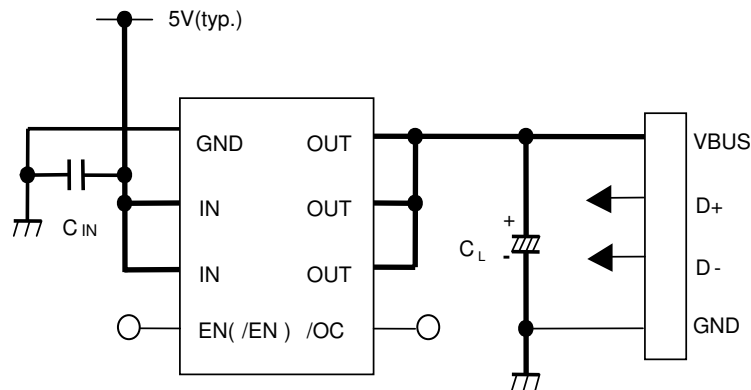

## ●Key Specifications

- Input voltage range: 2.7V to 5.5V
- ON resistance : 80mΩ(Typ.)
- Over current threshold: 0.3A min., 0.8A max.
- Standby current: 0.01μA (Typ.)
- Operating temperature range: -40°C to +85°C

## ●Package

SOP-J8

W(Typ.) D(Typ.) H (Max.)  
4.90mm x 6.00mm x 1.65mm

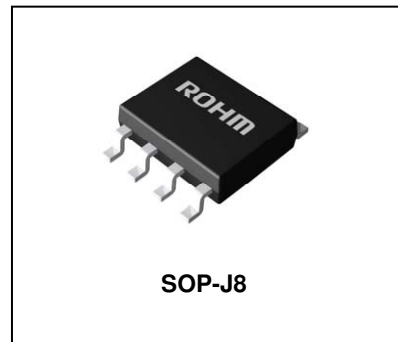

## ●Lineup

Over current threshold			Control input logic	Package		Orderable Part Number
Min.	Typ.	Max.				
0.3A	0.5A	0.8A	Low	SOP-J8	Reel of 2500	BD2045AFJ-E2
0.3A	0.5A	0.8A	High	SOP-J8	Reel of 2500	BD2055AFJ-E2

●Block Diagram

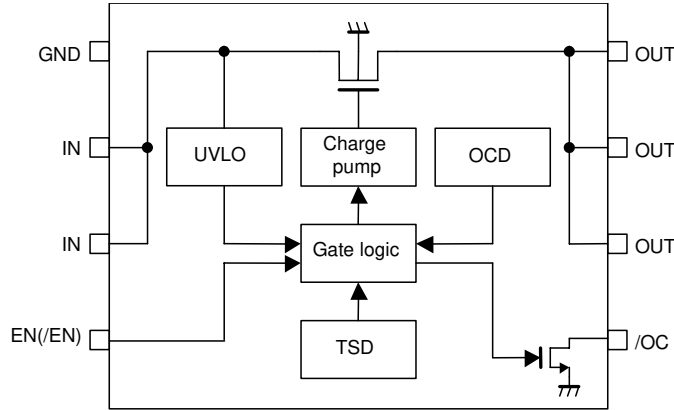

●Pin Configurations

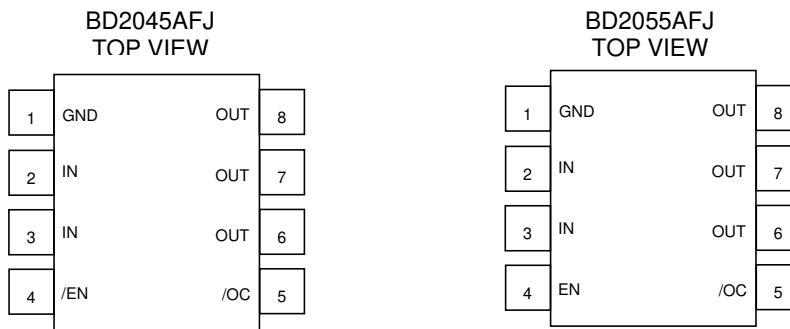

●Pin Descriptions

©BD2045AFJ

Pin No.	Symbol	I / O	Pin function
1	GND	I	Ground.
2, 3	IN	I	Power supply input. Input terminal to the power switch and power supply input terminal of the internal circuit. When used, connect each pin outside.
4	/EN	I	Enable input. Power switch on at Low level. High level input > 2.0V, Low level input < 0.8V.
5	/OC	O	Error flag output. Low at over current, thermal shutdown. Open drain output.
6, 7, 8	OUT	O	Power switch output. When used, connect each pin outside.

©BD2055AFJ

Pin No.	Symbol	I / O	Pin function
1	GND	I	Ground.
2, 3	IN	I	Power supply input. Input terminal to the power switch and power supply input terminal of the internal circuit. When used, connect each pin outside.
4	EN	I	Enable input. Power switch on at High level. High level input > 2.0V, Low level input < 0.8V
5	/OC	O	Error flag output. Low at over current, thermal shutdown. Open drain output.
6, 7, 8	OUT	O	Power switch output. When used, connect each pin outside.

### ● Absolute Maximum Ratings

Parameter	Symbol	Ratings	Unit
Supply voltage	V <sub>IN</sub>	-0.3 to 6.0	V
Enable voltage	V <sub>EN</sub> , V <sub>/EN</sub>	-0.3 to 6.0	V
/OC voltage	V <sub>/OC</sub>	-0.3 to 6.0	V
/OC current	I <sub>S/OC</sub>	10	mA
OUT voltage	V <sub>OUT</sub>	-0.3 to 6.0	V
Storage temperature	T <sub>STG</sub>	-55 to 150	°C
Power dissipation	PD	560 <sup>*1</sup>	mW

\*1 In case of exceeding Ta = 25°C, 4.48mW should be reduced per 1°C.

### ● Recommended Operating Range

Parameter	Symbol	Ratings	Unit
Operating voltage	V <sub>IN</sub>	2.7 to 5.5	V
Operating temperature	T <sub>OPR</sub>	-40 to 85	°C
Continuous output current	I <sub>LO</sub>	0 to 250	mA

### ● Electrical Characteristics

©BD2045AFJ (Unless otherwise specified, V<sub>IN</sub> = 5.0V, Ta = 25°C)

Parameter	Symbol	Limits			Unit	Condition
		Min.	Typ.	Max.		
Operating Current	I <sub>DD</sub>	-	90	120	μA	V <sub>EN</sub> = 0V, OUT = OPEN
Standby Current	I <sub>STB</sub>	-	0.01	1	μA	V <sub>EN</sub> = 5V, OUT = OPEN
/EN input voltage	V <sub>/EN</sub>	2.0	-	-	V	High input
	V <sub>/EN</sub>	-	-	0.8	V	Low input
		-	-	0.4	V	Low input 2.7V ≤ V <sub>IN</sub> ≤ 4.5V
/EN input current	I <sub>/EN</sub>	-1.0	0.01	1.0	μA	V <sub>EN</sub> = 0V or V <sub>/EN</sub> = 5V
/OC output LOW voltage	V <sub>/OC</sub>	-	-	0.5	V	I <sub>OC</sub> = 5mA
/OC output leak current	I <sub>L/OC</sub>	-	0.01	1	μA	V <sub>/OC</sub> = 5V
ON resistance	R <sub>ON</sub>	-	80	100	mΩ	I <sub>OUT</sub> = 250mA
Over-current Threshold	I <sub>TH</sub>	0.3	0.5	0.8	A	
Output current at short	I <sub>SC</sub>	0.3	0.5	0.7	A	V <sub>IN</sub> = 5V, V <sub>OUT</sub> = 0V, CL = 100μF (RMS)
Output rise time	T <sub>ON1</sub>	-	1.2	10	ms	R <sub>L</sub> = 20Ω, CL = OPEN
Output turn on time	T <sub>ON2</sub>	-	1.5	20	ms	
Output fall time	T <sub>OFF1</sub>	-	1	20	μs	
Output turn off time	T <sub>OFF2</sub>	-	3	40	μs	
UVLO threshold	V <sub>TUVH</sub>	2.1	2.3	2.5	V	Increasing V <sub>IN</sub>
	V <sub>TUVL</sub>	2.0	2.2	2.4	V	Decreasing V <sub>IN</sub>



## ●Electrical Characteristics - continued

©BD2055AFJ (Unless otherwise specified,  $V_{IN} = 5.0V$ ,  $T_a = 25^{\circ}C$ )

Parameter	Symbol	Limits			Unit	Condition
		Min.	Typ.	Max.		
Operating Current	$I_{DD}$	-	90	120	$\mu A$	$V_{EN} = 5V$ , $OUT = OPEN$
Standby Current	$I_{STB}$	-	0.01	1	$\mu A$	$V_{EN} = 0V$ , $OUT = OPEN$
EN input voltage	$V_{EN}$	2.0	-	-	V	High input
	$V_{EN}$	-	-	0.8	V	Low input
		-	-	0.4	V	Low input $2.7V \leq V_{IN} \leq 4.5V$
EN input current	$I_{EN}$	-1.0	0.01	1.0	$\mu A$	$V_{EN} = 0V$ or $V_{EN} = 5V$
/OC output LOW voltage	$V_{/OC}$	-	-	0.5	V	$I_{/OC} = 5mA$
/OC output leak current	$I_{L/OC}$	-	0.01	1	$\mu A$	$V_{/OC} = 5V$
ON resistance	$R_{ON}$	-	80	100	m $\Omega$	$I_{OUT} = 250mA$
Over-current Threshold	$I_{TH}$	0.3	0.5	0.8	A	
Output current at short	$I_{SC}$	0.3	0.5	0.7	A	$V_{IN} = 5V$ , $V_{OUT} = 0V$ , $C_L = 100\mu F$ (RMS)
Output rise time	$T_{ON1}$	-	1.2	10	ms	$R_L = 20\Omega$ , $C_L = OPEN$
Output turn on time	$T_{ON2}$	-	1.5	20	ms	
Output fall time	$T_{OFF1}$	-	1	20	$\mu s$	
Output turn off time	$T_{OFF2}$	-	3	40	$\mu s$	
UVLO Threshold	$V_{TUVH}$	2.1	2.3	2.5	V	Increasing $V_{IN}$
	$V_{TUVL}$	2.0	2.2	2.4	V	Decreasing $V_{IN}$

●Measurement Circuit

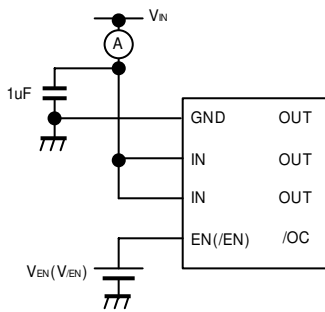

A. Operating current

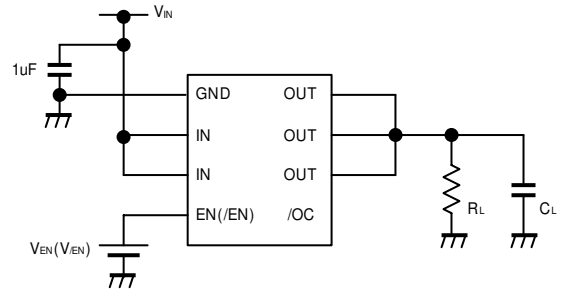

B. EN, /EN input voltage, Output rise, fall time

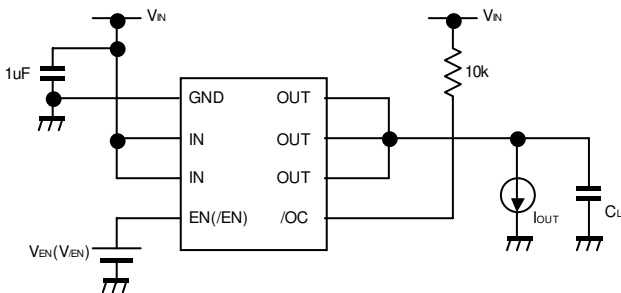

C. ON resistance, Over current detection

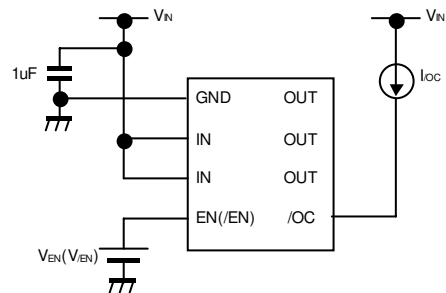

D. /OC output LOW voltage

Figure 1. Measurement circuit

●Timing Diagram

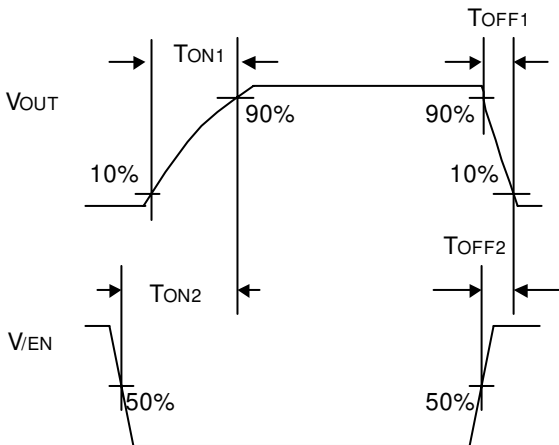

Figure 2. Timing diagram (BD2045AFJ)

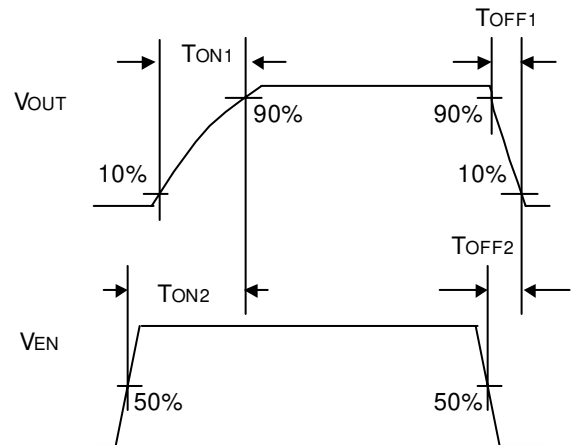

Figure 3. Timing diagram (BD2055AFJ)

● Typical Performance Curves

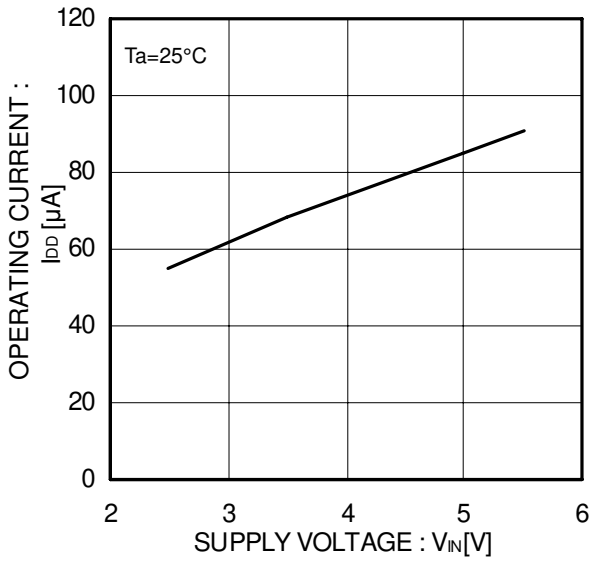

Figure 4. Operating current EN,/EN Enable

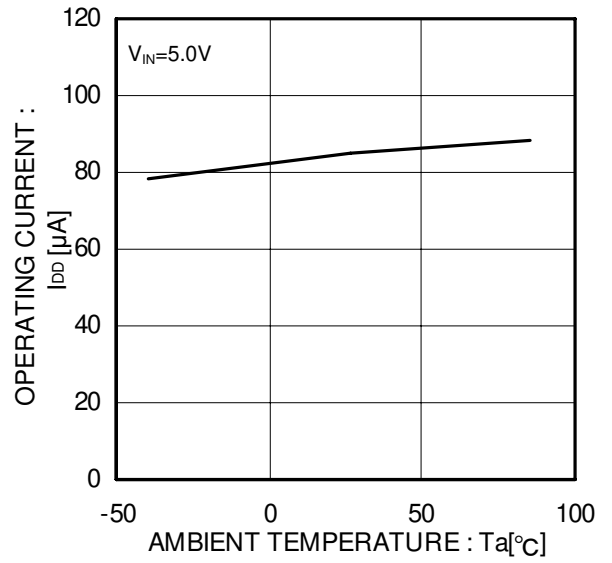

Figure 5. Operating current EN,/EN Enable

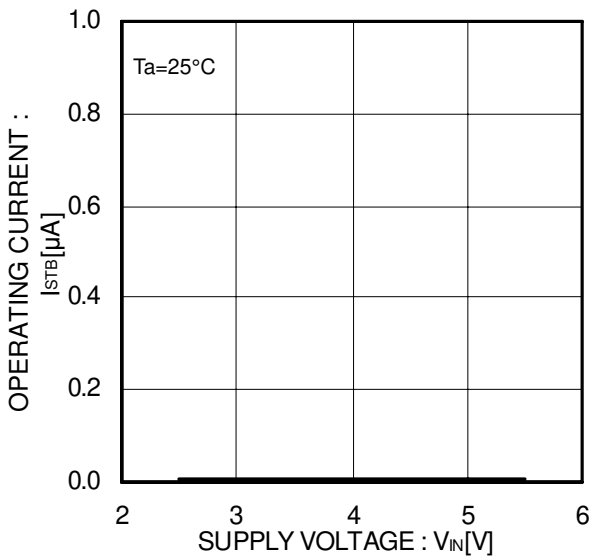

Figure 6. Operating current EN,/EN Disable

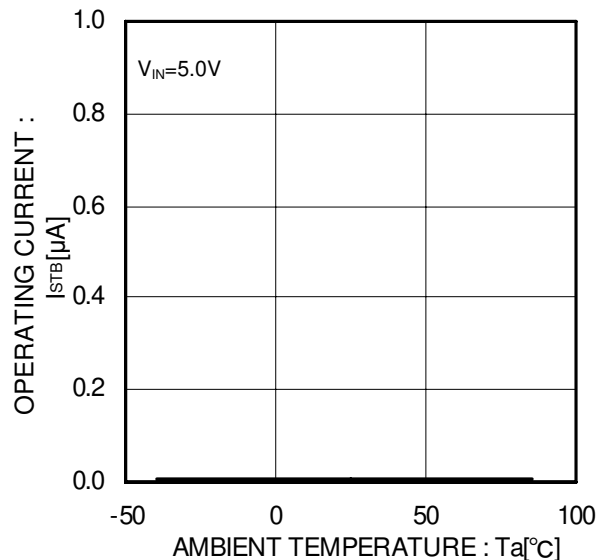

Figure 7. Operating current EN,/EN Disable

● Typical Performance Curves - continued

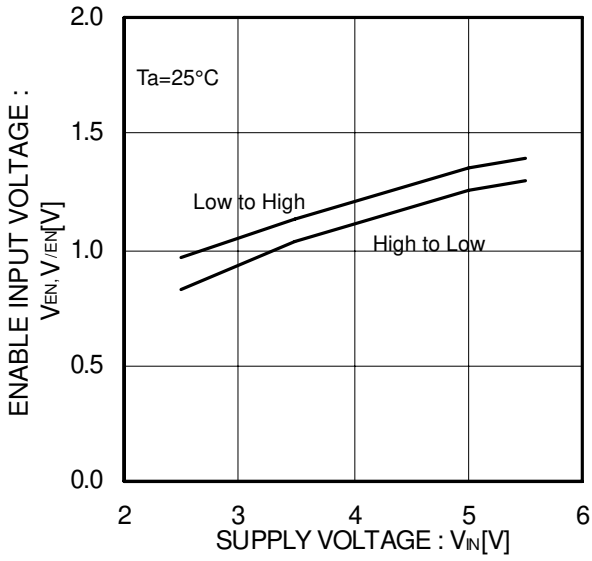

Figure 8. EN<sub>L</sub>/EN<sub>H</sub> input voltage

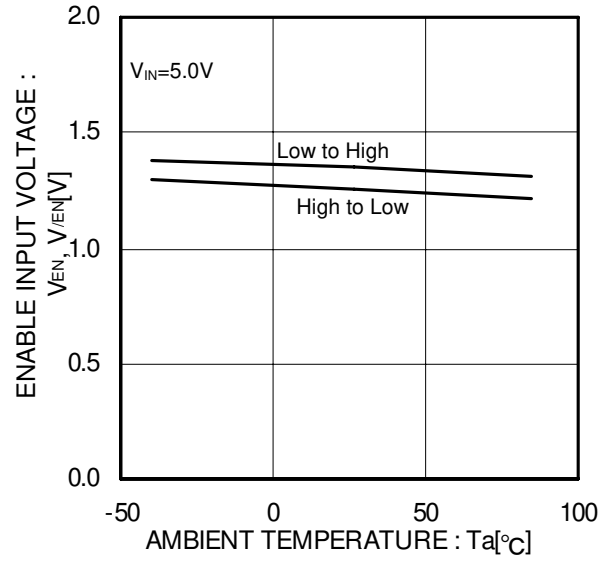

Figure 9. EN<sub>L</sub>/EN<sub>H</sub> input voltage

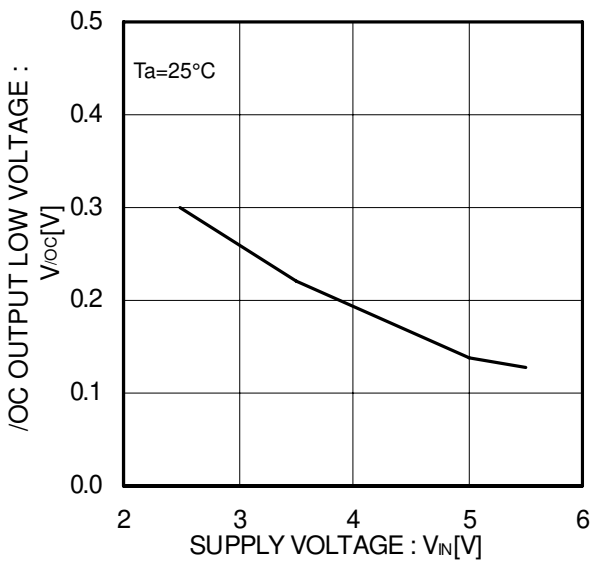

Figure 10. /OC output LOW voltage

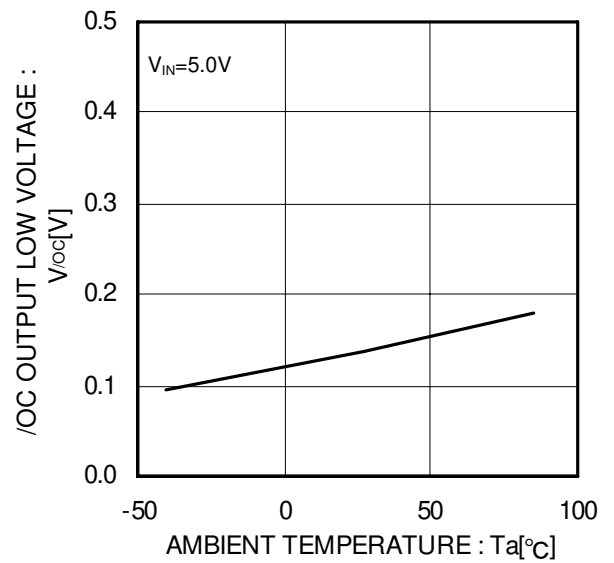

Figure 11. /OC output LOW voltage



● Typical Performance Curves - continued

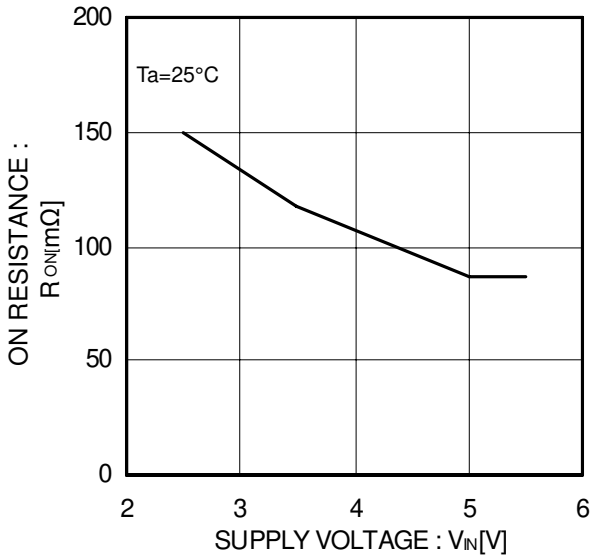

Figure 12. ON resistance

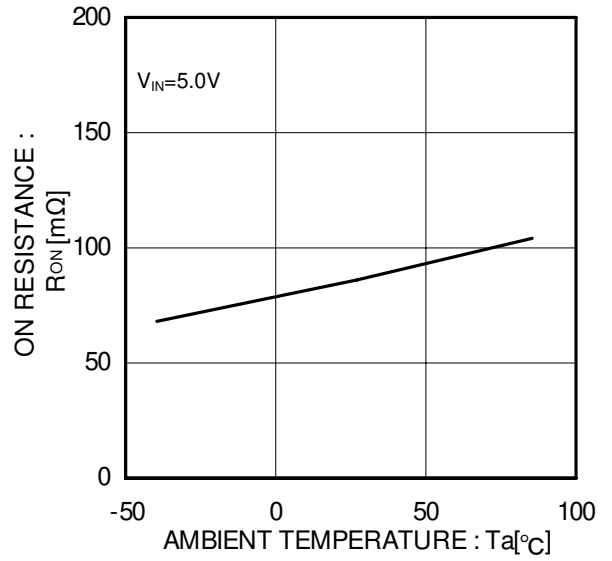

Figure 13. ON resistance

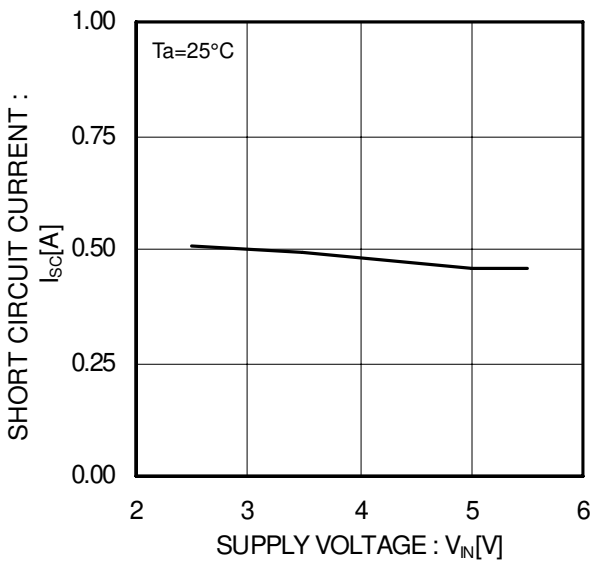

Figure 14. Output current at shortcircuit

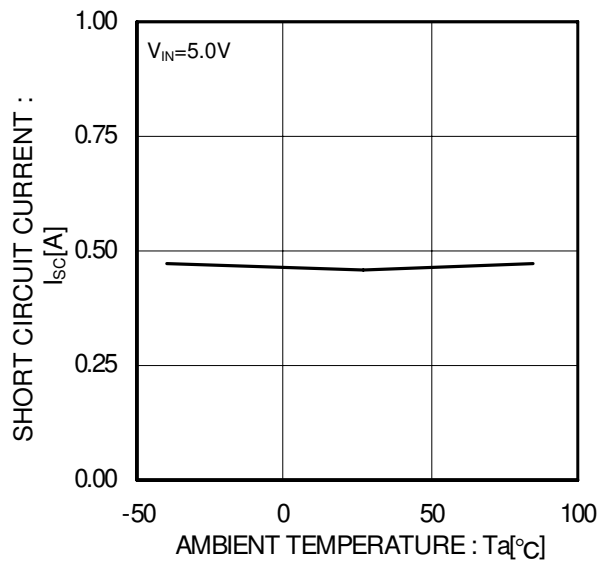

Figure 15. Output current at shortcircuit

● Typical Performance Curves - continued

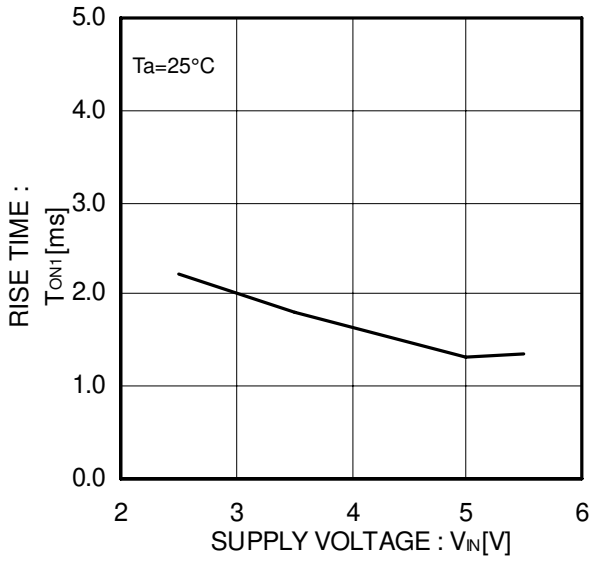

Figure 16. Output rise time

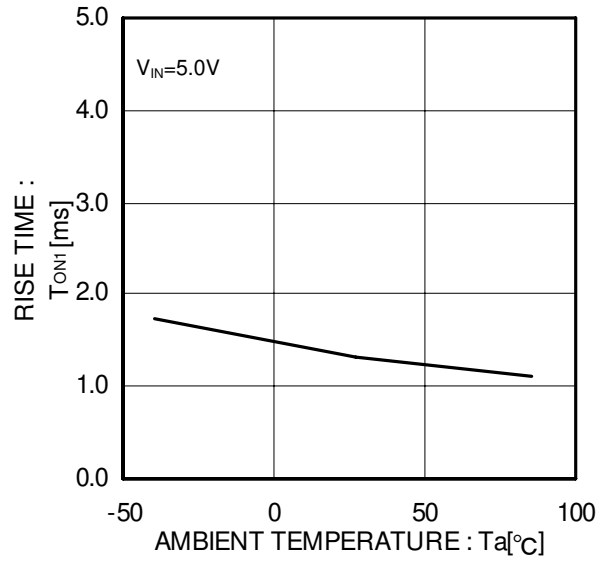

Figure 17. Output rise time

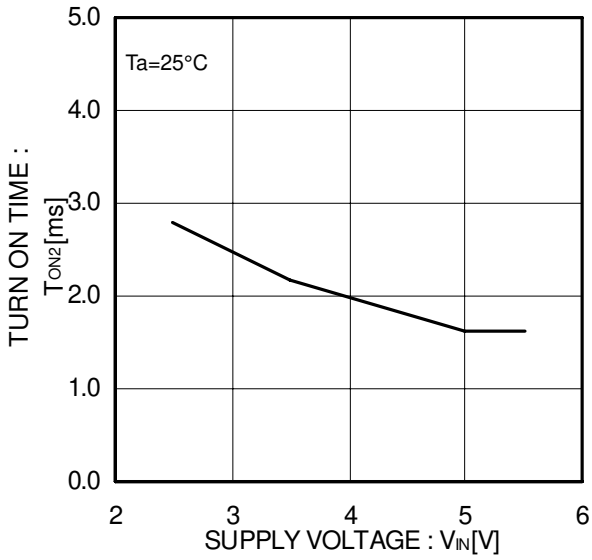

Figure 18. Output turn on time

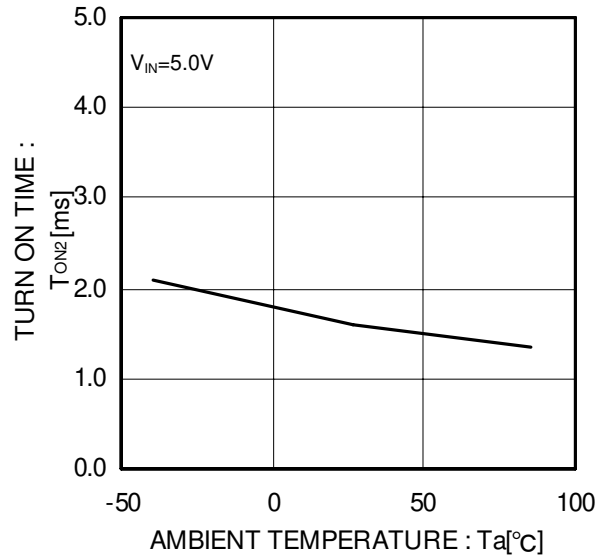

Figure 19. Output turn on time

● Typical Performance Curves - continued

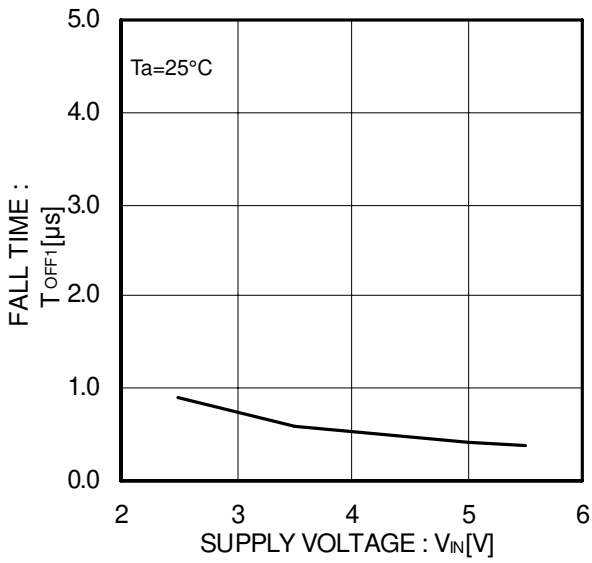

Figure 20. Output fall time

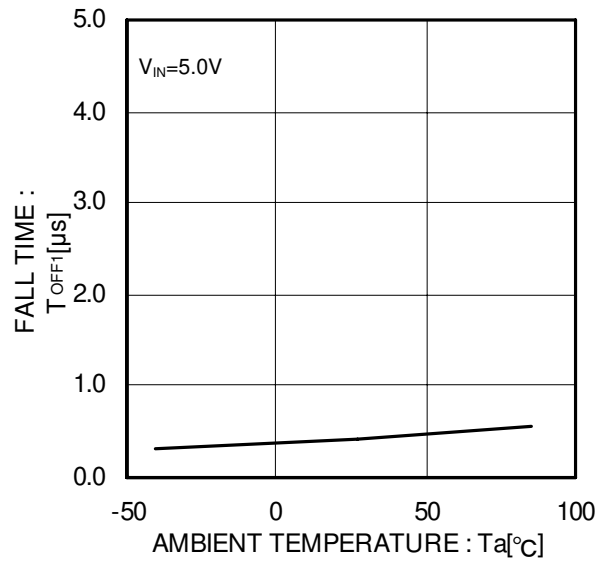

Figure 21. Output fall time

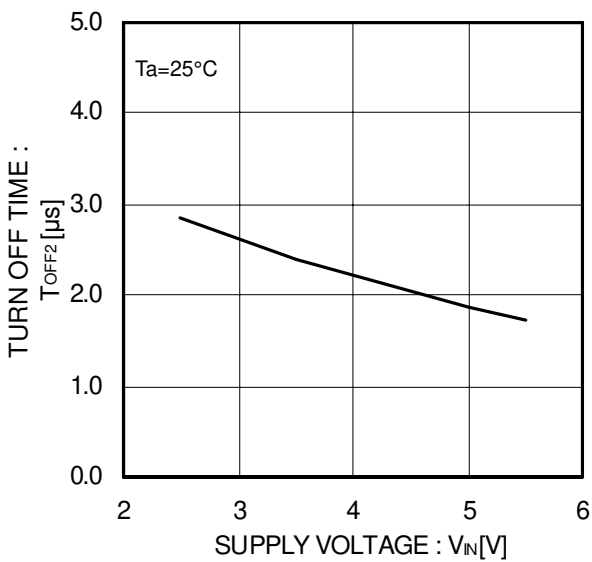

Figure 22. Output turn off time

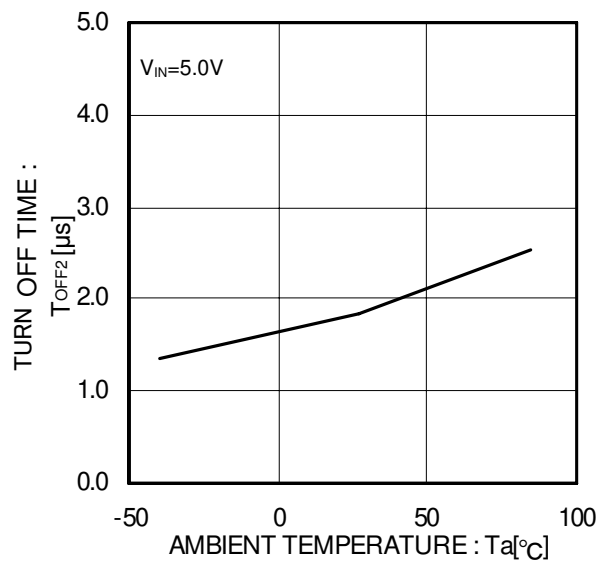

Figure 23. Output turn off time

● Typical Performance Curves - continued

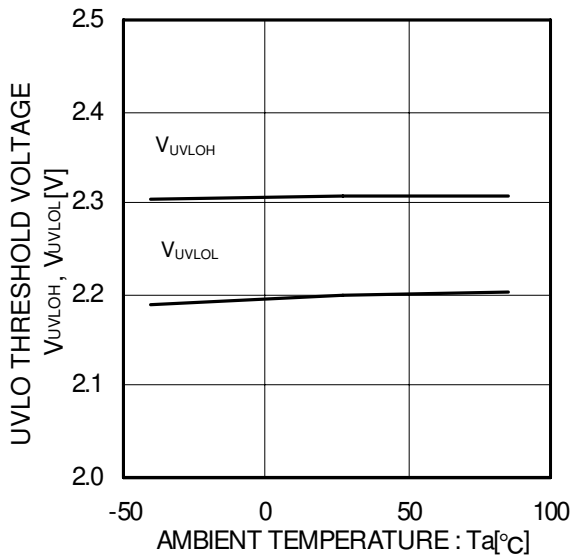

Figure 24. UVLO threshold voltage

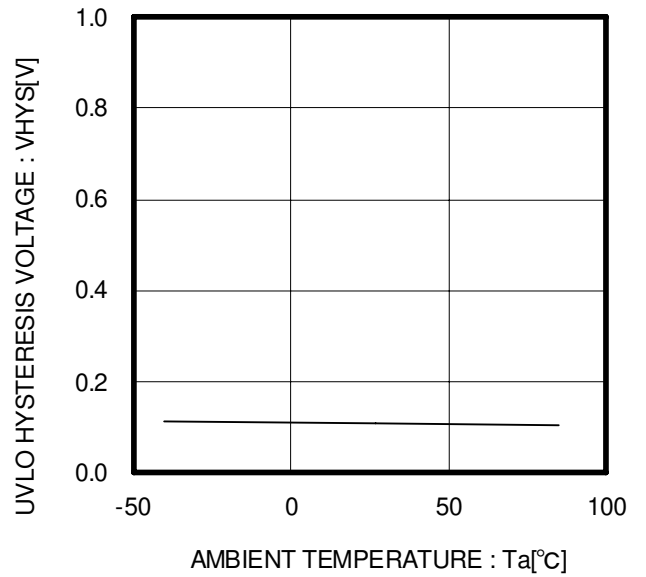

Figure 25. UVLO hysteresis voltage

● Typical Wave Forms

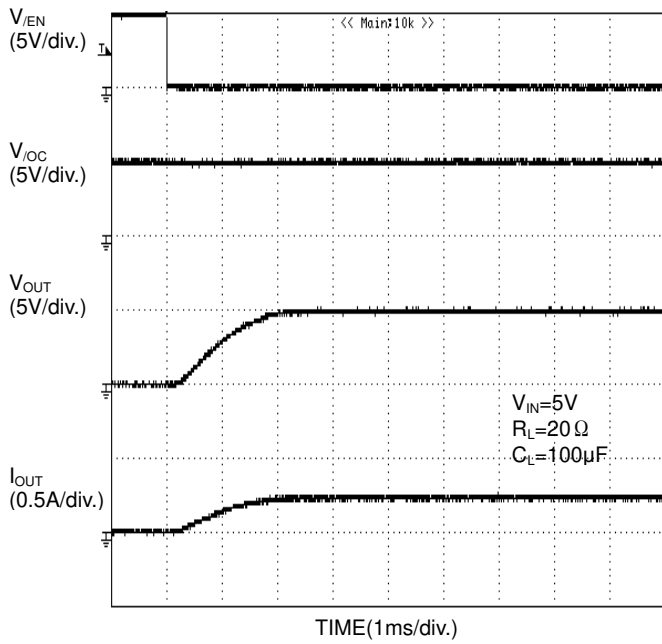

Figure 26. Output rise characteristic (BD2045AFJ)

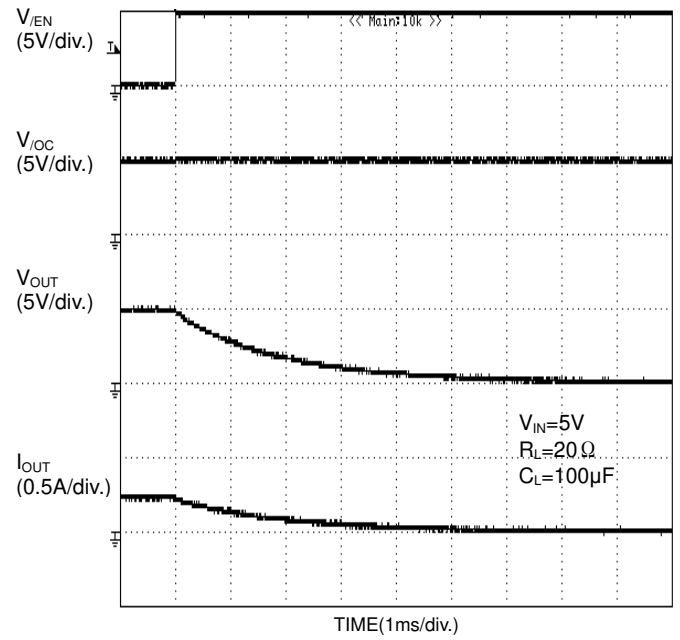

Figure 27. Output fall characteristic (BD2045AFJ)

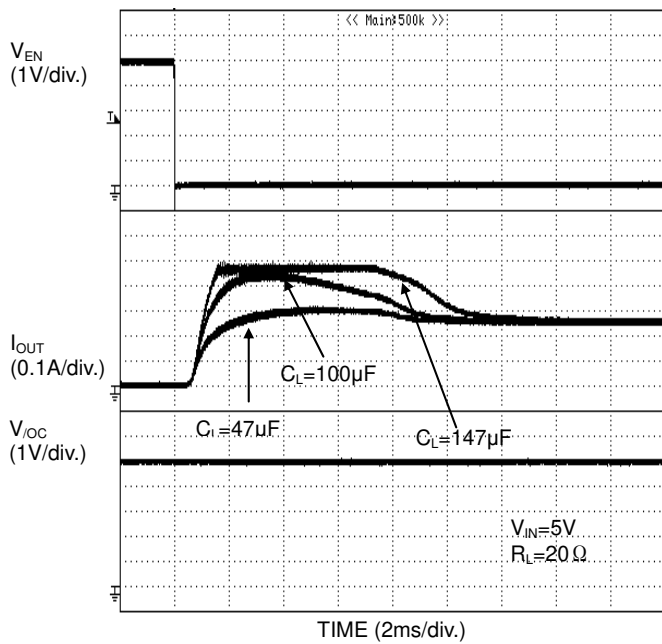

Figure 28. Inrush current response (BD2045AFJ)

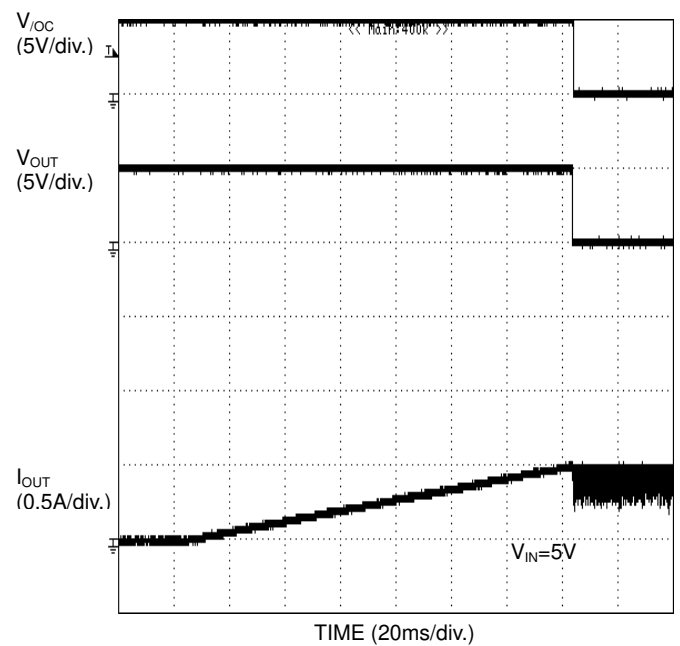

Figure 29. Over current response Ramped load (BD2045AFJ)

● Typical Wave Forms - continued

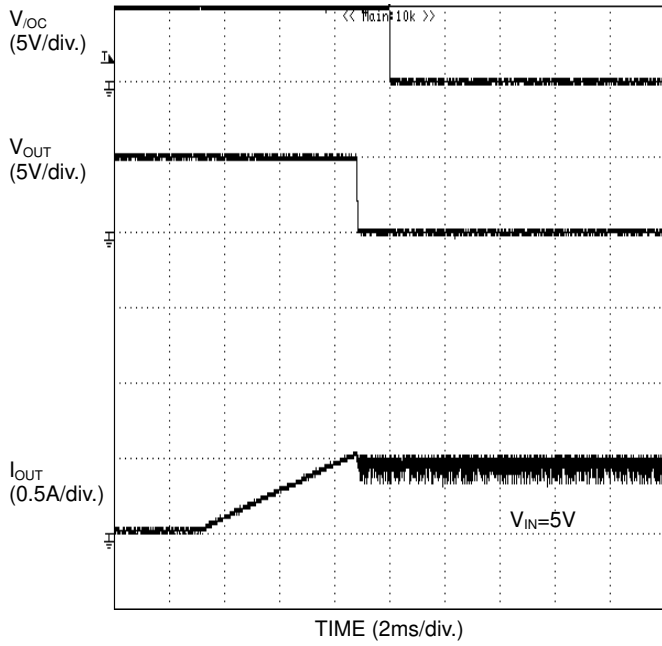

Figure 30. Over current response  
Ramped load  
(BD2045AFJ)

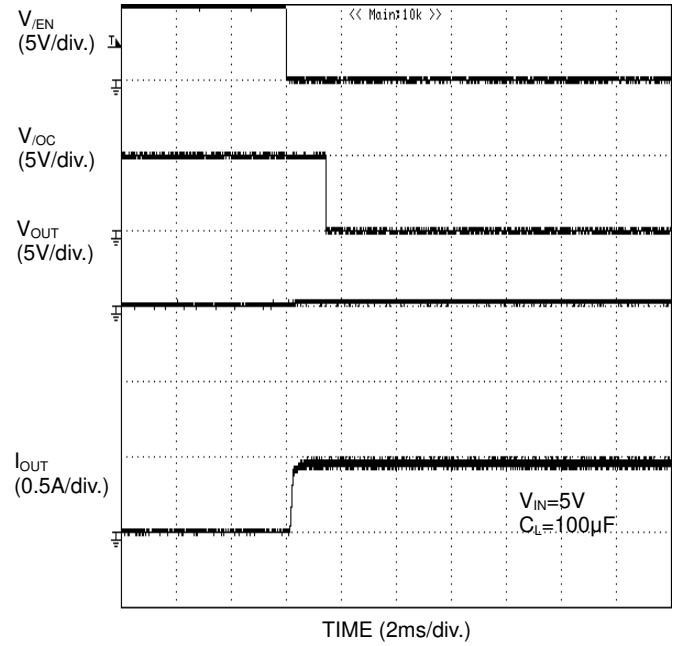

Figure 31. Over current response  
Enabled to short-circuit  
(BD2045AFJ)

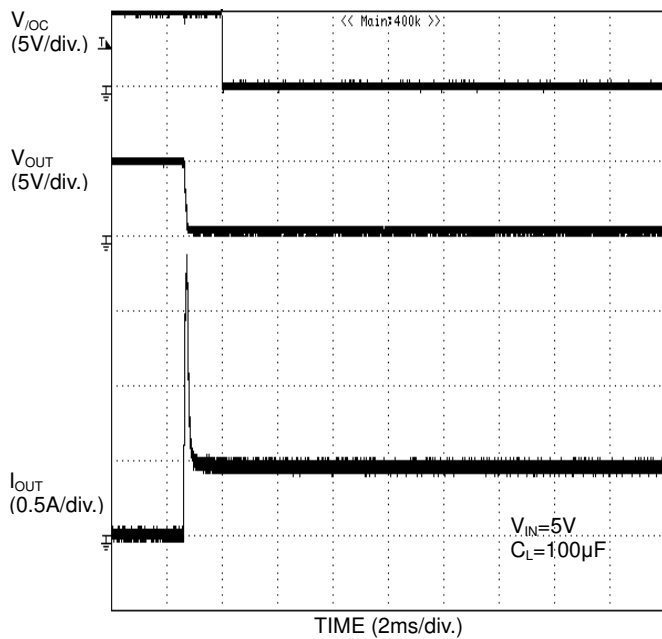

Figure 32. Over current response  
Enabled to short-circuit  
(BD2045AFJ)

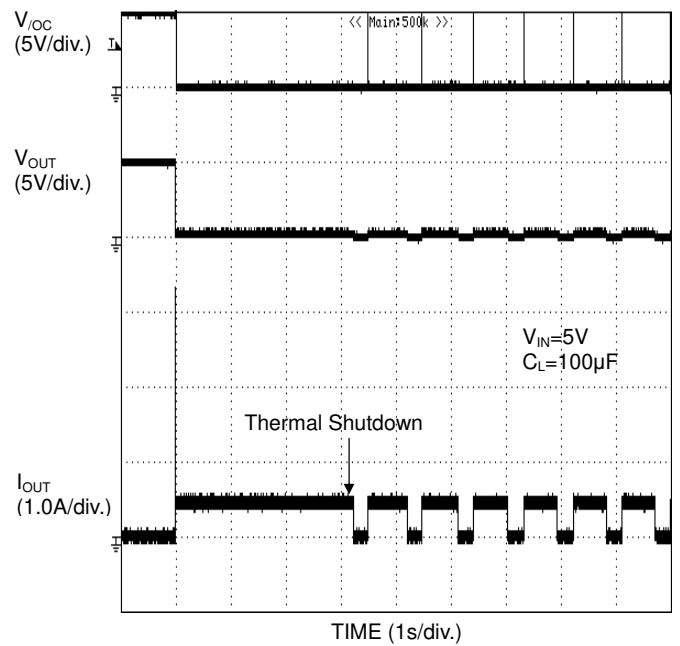

Figure 33. Over current response  
Enabled to short-circuit  
(BD2045AFJ)



● Typical Wave Forms - continued

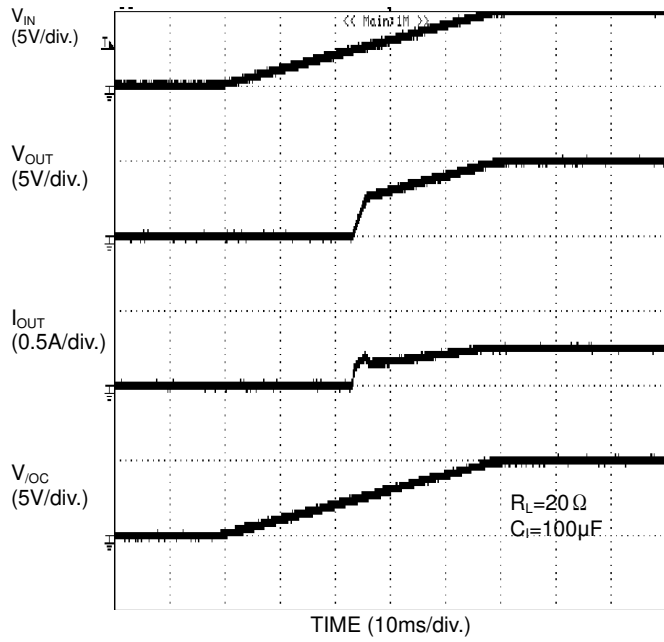

Figure 34. UVLO response Increasing  $V_{IN}$  (BD2045AFJ)

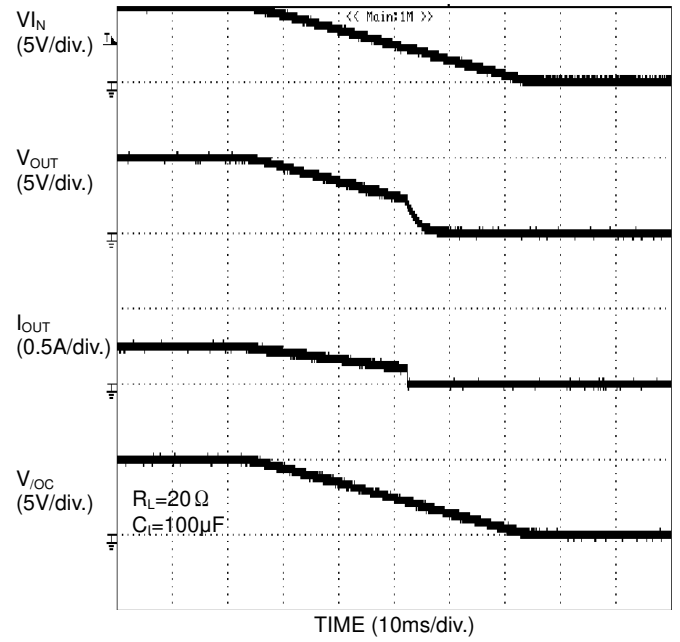
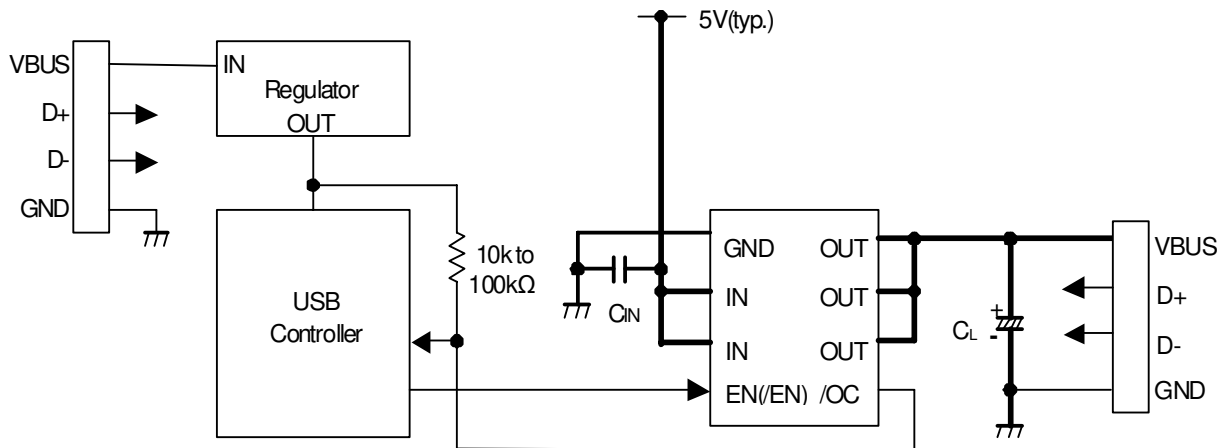

Figure 35. UVLO response Decreasing  $V_{IN}$  (BD2045AFJ)

Regarding the output rise/fall and over current detection characteristics of BD2055AFJ, refer to the characteristic of BD2045AFJ.

## ● Typical Application Circuit



## ● Application Information

When excessive current flows due to output short-circuit or so, ringing occurs because of inductance between power source line to IC, and may cause bad influences on IC operations. In order to avoid this case, connect a bypass capacitor across IN terminal and GND terminal of IC. 1μF or higher is recommended.

Pull up /OC output by resistance value of 10kΩ to 100kΩ.

Set up value which satisfies the application as C<sub>L</sub>.

This application circuit does not guarantee its operation.

When using the circuit with changes to the external circuit constants, make sure to leave an adequate margin for external components including AC/DC characteristics as well as dispersion of the IC.

## ● Functional Description

### 1. Switch operation

IN terminal and OUT terminal are connected to the drain and the source of switch MOSFET respectively. The IN terminal is used also as power source input to the internal control circuit.

When the switch is turned on from EN/EN control input, the IN terminal and OUT terminal are connected by an 80mΩ switch. In ON status, the switch is bidirectional. Therefore, when the potential of OUT terminal is higher than that of the IN terminal, current flows from OUT terminal to IN terminal.

Since a parasitic diode between the drain and the source of switch MOSFET is not present in the off status, it is possible to prevent current from flowing reversely from OUT to IN.

### 2. Thermal shutdown circuit (TSD)

If over current would continue, the temperature of the IC would increase drastically. If the junction temperature were beyond 140°C (typ.) in the condition of over current detection, thermal shutdown circuit operates and makes power switch turn off and outputs error flag (/OC). Then, when the junction temperature decreases lower than 120°C (typ.), power switch is turned on and error flag (/OC) is cancelled. Unless the increasing of the chip's temperature is removed or the output of power switch is turned off, this operation repeats.

The thermal shutdown circuit operates when the switch is on (EN,/EN signal is active).

### 3. Over current detection (OCD)

The over current detection circuit limits current (I<sub>SC</sub>) and outputs an error flag (/OC) when current flowing in each switch MOSFET exceeds a specified value. There are three types of response against over current. The over current detection circuit works when the switch is on (EN,/EN signal is active).

- 3-1. When the switch is turned on while the output is in short-circuit status, the switch goes into current limit status immediately.
- 3-2. When the output short-circuits or high-current load is connected while the switch is on, very large current flows until the over current limit circuit reacts. When the current detection and limit circuit works, current limitation is carried out.
- 3-3. When the output current increases gradually, current limitation does not work until the output current exceeds the over current detection value. When it exceeds the detection value, current limitation is carried out.

4. Under voltage lockout (UVLO)

UVLO circuit prevents the switch from turning on until the  $V_{IN}$  exceeds 2.3V(Typ.). If the  $V_{IN}$  drops below 2.2V(Typ.) while the switch turns on, then UVLO shuts off the power switch. UVLO has hysteresis of 100mV(Typ). Under voltage lockout circuit works when the switch is on (EN,/EN signal is active).

5. Error flag (/OC) output

Error flag output is an N-MOS open drain output. At detection of over current and/or thermal shutdown, the output level is low.

Over current detection has delay filter. This delay filter prevents instantaneous current detection such as surge current at switch on, hot plug from being informed to outside.

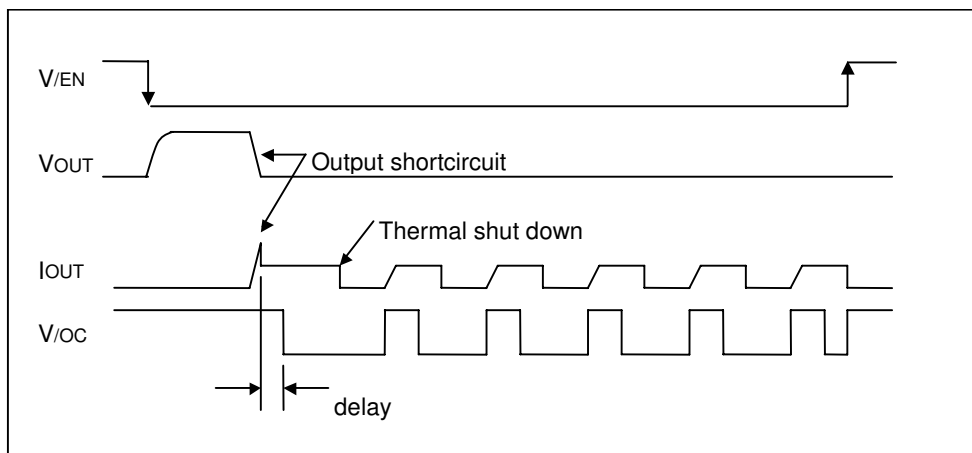

Figure 36. Over current detection, thermal shutdown timing (BD2045AFJ)

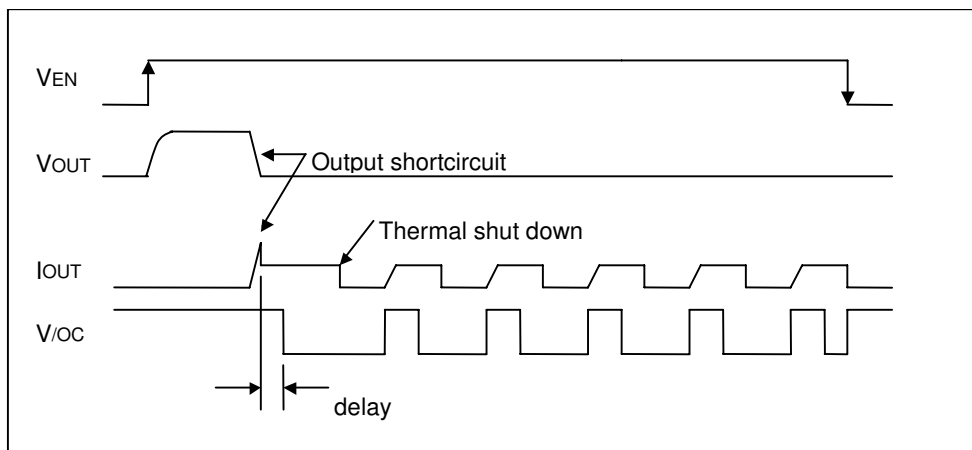

Figure 37. Over current detection, thermal shutdown timing (BD2055AFJ)

● Power Dissipation  
(SOP-J8)

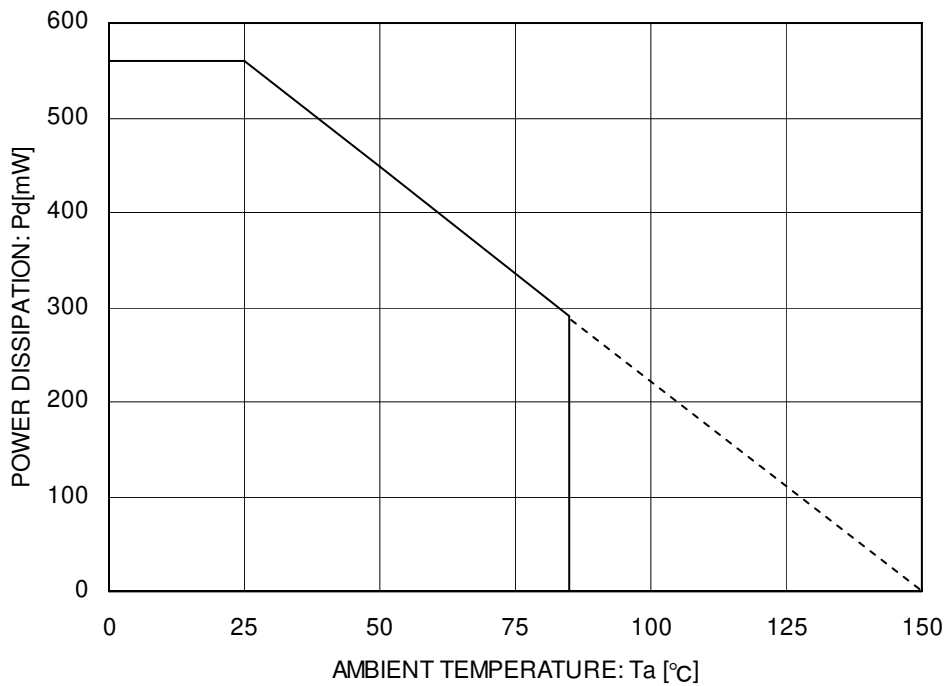

Figure 38. Power dissipation curve (Pd-Ta Curve)

● I/O Equivalence Circuit

Symbol	Pin No	Equivalence circuit
EN(/EN)	4	
/OC	5	
OUT	6,7,8	

●Operational Notes

- (1) Absolute maximum ratings  
Operating the IC over the absolute maximum ratings may damage the IC. The damage can either be a short circuit between pins or an open circuit between pins. Therefore, it is important to consider circuit protection measures, such as adding a fuse, in case the IC is operated over the absolute maximum ratings.
- (2) Recommended operating conditions  
These conditions represent a range within which the expected characteristics of the IC can be approximately obtained. The electrical characteristics are guaranteed under the conditions of each parameter.
- (3) Reverse connection of power supply  
Connecting the power supply in reverse polarity can damage the IC. Take precautions against reverse polarity when connecting the power supply, such as mounting an external diode between the power supply and the IC's power supply terminals.
- (4) Power supply lines  
Design the PCB layout pattern to provide low impedance ground and supply lines. Separate the ground and supply lines of the digital block from affecting the analog block. Furthermore, connect a capacitor to ground at all power supply pins. Consider the effect of temperature and aging on the capacitance value when using electrolytic capacitors.
- (5) Ground Voltage  
The voltage of the ground pin must be the lowest voltage of all pins of the IC at all operating conditions. Ensure that no pins are at a voltage below the ground pin at any time, even during transient condition.
- (6) Short between pins and mounting errors  
Be careful when mounting the IC on printed circuit boards. The IC may be damaged if it is mounted in a wrong orientation or if pins are shorted together. Short circuit may be caused by conductive particles caught between the pins.
- (7) Operation under strong electromagnetic field  
Operating the IC in the presence of a strong electromagnetic field may cause the IC to malfunction.
- (8) Testing on application boards  
When testing the IC on an application board, connecting a capacitor directly to a low-impedance output pin may subject the IC to stress. Always discharge capacitors completely after each process or step. The IC's power supply should always be turned off completely before connecting or removing it from the test setup during the inspection process. To prevent damage from static discharge, ground the IC during assembly and use similar precautions during transport and storage.
- (9) Regarding input pins of the IC  
This monolithic IC contains P+ isolation and P substrate layers between adjacent elements in order to keep them isolated. P-N junctions are formed at the intersection of the P layers with the N layers of other elements, creating a parasitic diode or transistor. For example (refer to figure below):

When  $GND > Pin A$  and  $GND > Pin B$ , the P-N junction operates as a parasitic diode

When  $GND > Pin B$ , the P-N junction operates as a parasitic transistor.

Parasitic diodes inevitably occur in the structure of the IC. The operation of parasitic diodes can result in mutual interference among circuits, operational faults, or physical damage. Therefore, conditions that cause these diodes to operate, such as applying a voltage lower than the GND voltage to an input pin (and thus to the P substrate) should be avoided.

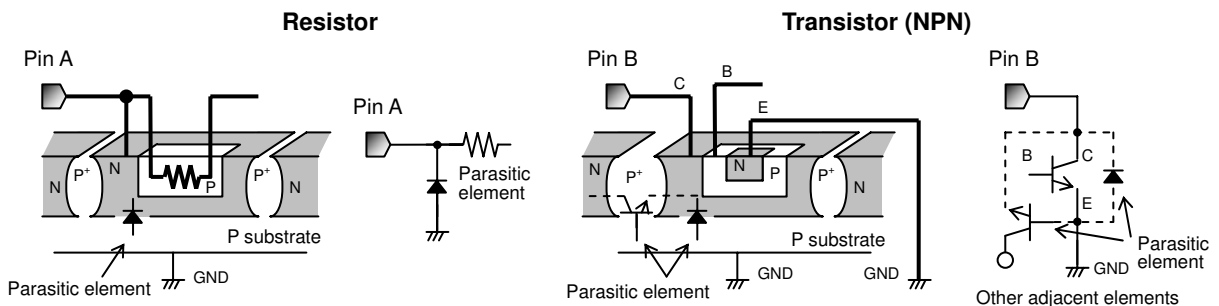

Figure 39. Example of monolithic IC structure

## (10) GND wiring pattern

When using both small-signal and large-current GND traces, the two ground traces should be routed separately but connected to a single ground at the reference point of the application board to avoid fluctuations in the small-signal ground caused by large currents. Also ensure that the GND traces of external components do not cause variations on the GND voltage. The power supply and ground lines must be as short and thick as possible to reduce line impedance.

## (11) External Capacitor

When using a ceramic capacitor, determine the dielectric constant considering the change of capacitance with temperature and the decrease in nominal capacitance due to DC bias and others.

## (12) Thermal shutdown circuit (TSD)

The IC incorporates a built-in thermal shutdown circuit, which is designed to turn off the IC when the internal temperature of the IC reaches a specified value. Do not continue to operate the IC after this function is activated. Do not use the IC in conditions where this function will always be activated.

## (13) Thermal consideration

Use a thermal design that allows for a sufficient margin by taking into account the permissible power dissipation (Pd) in actual operating conditions. Consider Pc that does not exceed Pd in actual operating conditions ( $P_c \geq P_d$ ).

$$\text{Package Power dissipation} \quad : P_d \text{ (W)} = (T_{j\max} - T_a) / \theta_{ja}$$

$$\text{Power dissipation} \quad : P_c \text{ (W)} = (V_{cc} - V_o) \times I_o + V_{cc} \times I_b$$

$T_{j\max}$  : Maximum junction temperature=150°C,  $T_a$  : Peripheral temperature[°C],  
 $\theta_{ja}$  : Thermal resistance of package-ambience[°C/W],  $P_d$  : Package Power dissipation [W],  
 $P_c$  : Power dissipation [W],  $V_{cc}$  : Input Voltage,  $V_o$  : Output Voltage,  $I_o$  : Load,  $I_b$  : Bias Current



●Ordering Information

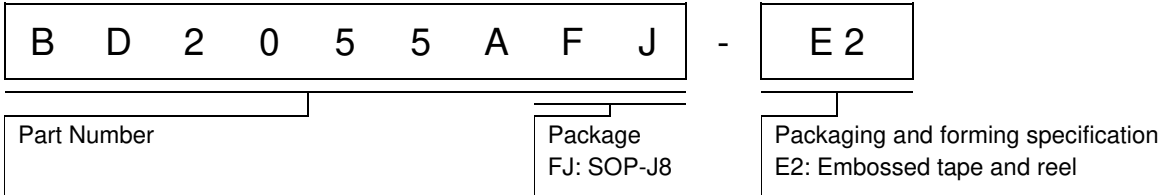
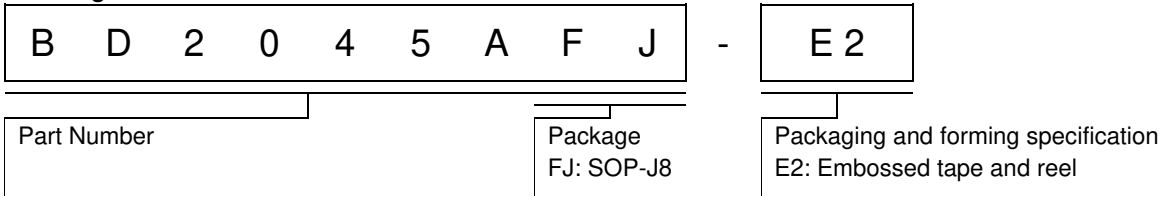

●Marking Diagram

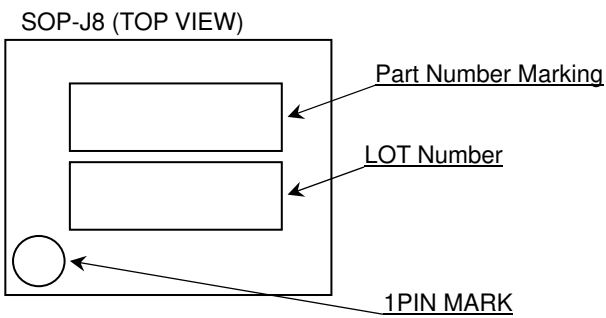

Part Number	Part Number Marking
BD2045AFJ	D045A
BD2055AFJ	D055A

●Physical Dimension, Tape and Reel Information

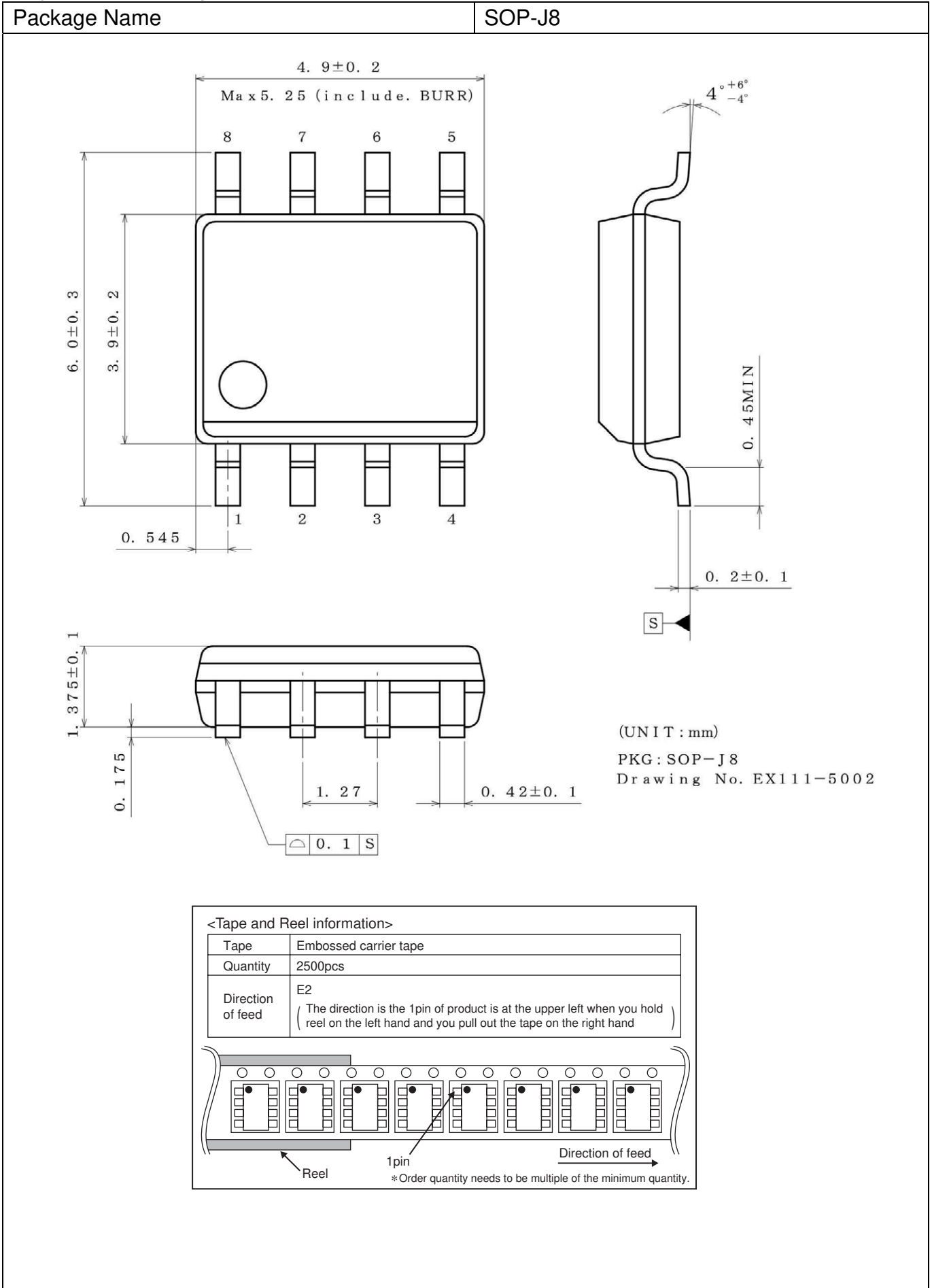

## ●Revision History

Date	Revision	Changes
11.Mar.2013	001	New Release

# Notice

## ●General Precaution

- 1) Before you use our Products, you are requested to carefully read this document and fully understand its contents. ROHM shall not be in any way responsible or liable for failure, malfunction or accident arising from the use of any ROHM's Products against warning, caution or note contained in this document.
- 2) All information contained in this document is current as of the issuing date and subject to change without any prior notice. Before purchasing or using ROHM's Products, please confirm the latest information with a ROHM sales representative.

## ●Precaution on using ROHM Products

- 1) Our Products are designed and manufactured for application in ordinary electronic equipments (such as AV equipment, OA equipment, telecommunication equipment, home electronic appliances, amusement equipment, etc.). If you intend to use our Products in devices requiring extremely high reliability (such as medical equipment, transport equipment, traffic equipment, aircraft/spacecraft, nuclear power controllers, fuel controllers, car equipment including car accessories, safety devices, etc.) and whose malfunction or failure may cause loss of human life, bodily injury or serious damage to property ("Specific Applications"), please consult with the ROHM sales representative in advance. Unless otherwise agreed in writing by ROHM in advance, ROHM shall not be in any way responsible or liable for any damages, expenses or losses incurred by you or third parties arising from the use of any ROHM's Products for Specific Applications.
- 2) ROHM designs and manufactures its Products subject to strict quality control system. However, semiconductor products can fail or malfunction at a certain rate. Please be sure to implement, at your own responsibilities, adequate safety measures including but not limited to fail-safe design against the physical injury, damage to any property, which a failure or malfunction of our Products may cause. The following are examples of safety measures:
  - [a] Installation of protection circuits or other protective devices to improve system safety
  - [b] Installation of redundant circuits to reduce the impact of single or multiple circuit failure
- 3) Our Products are designed and manufactured for use under standard conditions and not under any special or extraordinary environments or conditions, as exemplified below. Accordingly, ROHM shall not be in any way responsible or liable for any damages, expenses or losses arising from the use of any ROHM's Products under any special or extraordinary environments or conditions. If you intend to use our Products under any special or extraordinary environments or conditions (as exemplified below), your independent verification and confirmation of product performance, reliability, etc. prior to use, must be necessary:
  - [a] Use of our Products in any types of liquid, including water, oils, chemicals, and organic solvents
  - [b] Use of our Products outdoors or in places where the Products are exposed to direct sunlight or dust
  - [c] Use of our Products in places where the Products are exposed to sea wind or corrosive gases, including Cl<sub>2</sub>, H<sub>2</sub>S, NH<sub>3</sub>, SO<sub>2</sub>, and NO<sub>2</sub>
  - [d] Use of our Products in places where the Products are exposed to static electricity or electromagnetic waves
  - [e] Use of our Products in proximity to heat-producing components, plastic cords, or other flammable items
  - [f] Sealing or coating our Products with resin or other coating materials
  - [g] Use of our Products without cleaning residue of flux (even if you use no-clean type fluxes, cleaning residue of flux is recommended); or Washing our Products by using water or water-soluble cleaning agents for cleaning residue after soldering
  - [h] Use of the Products in places subject to dew condensation
- 4) The Products are not subject to radiation-proof design.
- 5) Please verify and confirm characteristics of the final or mounted products in using the Products.
- 6) In particular, if a transient load (a large amount of load applied in a short period of time, such as pulse) is applied, confirmation of performance characteristics after on-board mounting is strongly recommended. Avoid applying power exceeding normal rated power; exceeding the power rating under steady-state loading condition may negatively affect product performance and reliability.
- 7) De-rate Power Dissipation (Pd) depending on Ambient temperature (Ta). When used in sealed area, confirm the actual ambient temperature.
- 8) Confirm that operation temperature is within the specified range described in the product specification.
- 9) ROHM shall not be in any way responsible or liable for failure induced under deviant condition from what is defined in this document.

● **Precaution for Mounting / Circuit board design**

- 1) When a highly active halogenous (chlorine, bromine, etc.) flux is used, the residue of flux may negatively affect product performance and reliability.
- 2) In principle, the reflow soldering method must be used; if flow soldering method is preferred, please consult with the ROHM representative in advance.

For details, please refer to ROHM Mounting specification

● **Precautions Regarding Application Examples and External Circuits**

- 1) If change is made to the constant of an external circuit, please allow a sufficient margin considering variations of the characteristics of the Products and external components, including transient characteristics, as well as static characteristics.
- 2) You agree that application notes, reference designs, and associated data and information contained in this document are presented only as guidance for Products use. Therefore, in case you use such information, you are solely responsible for it and you must exercise your own independent verification and judgment in the use of such information contained in this document. ROHM shall not be in any way responsible or liable for any damages, expenses or losses incurred by you or third parties arising from the use of such information.

● **Precaution for Electrostatic**

This Product is electrostatic sensitive product, which may be damaged due to electrostatic discharge. Please take proper caution in your manufacturing process and storage so that voltage exceeding the Products maximum rating will not be applied to Products. Please take special care under dry condition (e.g. Grounding of human body / equipment / solder iron, isolation from charged objects, setting of Ionizer, friction prevention and temperature / humidity control).

● **Precaution for Storage / Transportation**

- 1) Product performance and soldered connections may deteriorate if the Products are stored in the places where:
  - [a] the Products are exposed to sea winds or corrosive gases, including Cl<sub>2</sub>, H<sub>2</sub>S, NH<sub>3</sub>, SO<sub>2</sub>, and NO<sub>2</sub>
  - [b] the temperature or humidity exceeds those recommended by ROHM
  - [c] the Products are exposed to direct sunshine or condensation
  - [d] the Products are exposed to high Electrostatic
- 2) Even under ROHM recommended storage condition, solderability of products out of recommended storage time period may be degraded. It is strongly recommended to confirm solderability before using Products of which storage time is exceeding the recommended storage time period.
- 3) Store / transport cartons in the correct direction, which is indicated on a carton with a symbol. Otherwise bent leads may occur due to excessive stress applied when dropping of a carton.
- 4) Use Products within the specified time after opening a humidity barrier bag. Baking is required before using Products of which storage time is exceeding the recommended storage time period.

● **Precaution for Product Label**

QR code printed on ROHM Products label is for ROHM's internal use only.

● **Precaution for Disposition**

When disposing Products please dispose them properly using an authorized industry waste company.

● **Precaution for Foreign Exchange and Foreign Trade act**

Since our Products might fall under controlled goods prescribed by the applicable foreign exchange and foreign trade act, please consult with ROHM representative in case of export.

● **Precaution Regarding Intellectual Property Rights**

- 1) All information and data including but not limited to application example contained in this document is for reference only. ROHM does not warrant that foregoing information or data will not infringe any intellectual property rights or any other rights of any third party regarding such information or data. ROHM shall not be in any way responsible or liable for infringement of any intellectual property rights or other damages arising from use of such information or data.:
- 2) No license, expressly or implied, is granted hereby under any intellectual property rights or other rights of ROHM or any third parties with respect to the information contained in this document.

●Other Precaution

- 1) The information contained in this document is provided on an "as is" basis and ROHM does not warrant that all information contained in this document is accurate and/or error-free. ROHM shall not be in any way responsible or liable for any damages, expenses or losses incurred by you or third parties resulting from inaccuracy or errors of or concerning such information.
- 2) This document may not be reprinted or reproduced, in whole or in part, without prior written consent of ROHM.
- 3) The Products may not be disassembled, converted, modified, reproduced or otherwise changed without prior written consent of ROHM.
- 4) In no event shall you use in any way whatsoever the Products and the related technical information contained in the Products or this document for any military purposes, including but not limited to, the development of mass-destruction weapons.
- 5) The proper names of companies or products described in this document are trademarks or registered trademarks of ROHM, its affiliated companies or third parties.