



Chipsmall Limited consists of a professional team with an average of over 10 year of expertise in the distribution of electronic components. Based in Hongkong, we have already established firm and mutual-benefit business relationships with customers from,Europe,America and south Asia,supplying obsolete and hard-to-find components to meet their specific needs.

With the principle of “Quality Parts,Customers Priority,Honest Operation,and Considerate Service”,our business mainly focus on the distribution of electronic components. Line cards we deal with include Microchip,ALPS,ROHM,Xilinx,Pulse,ON,Everlight and Freescale. Main products comprise IC,Modules,Potentiometer,IC Socket,Relay,Connector.Our parts cover such applications as commercial,industrial, and automotives areas.

We are looking forward to setting up business relationship with you and hope to provide you with the best service and solution. Let us make a better world for our industry!



## Contact us

Tel: +86-755-8981 8866 Fax: +86-755-8427 6832

Email & Skype: info@chipsmall.com Web: www.chipsmall.com

Address: A1208, Overseas Decoration Building, #122 Zhenhua RD., Futian, Shenzhen, China



## Middle Power Class-D Speaker Amplifiers

# Analog Input / BTL Output Class-D Speaker Amplifier



BD5413EFV

No.10075EBT01

**●Description**

BD5413EFV is a 5W + 5W stereo class-D power amplifier specifically developed for low power consumption and low heat generation applications like powered speakers. BD5413EFV employs the state-of-the-art BCD (Bipolar, CMOS and DMOS) process technology to eliminate a turn-on resistance in the output power stage and an internal loss due to a wiring resistance as much as possible, achieving a high performance of 80% (4W + 4W output with a load resistance of 8Ω). In addition, BD5413EFV employs a compact power package which dissipates heat via the rear to achieve low power consumption and low heat generation so that the need for connecting an external heat radiator can be eliminated up to a total output of 12.8W. This product meets the needs for compact, thin sound generation systems and powerful, high-quality sound reproduction.

**●Features**

- 1) Small output noise voltage capable of achieving a high S/N set  
Input conversion noise voltage =  $2.8\mu\text{Vrms}$   
A bipolar differential is used for input amplifier to eliminate 1/f noise.
- 2) Support of power supply voltage ranging from 6V to 10.5V  
A supply voltage range is supported that matches an AC adaptor or battery cell driven set.  
When a set is battery driven, its operating time can be extended by means of a high performance class-D amplifier.
- 3) Support of low current consumption mode  
A circuit current in shut-down mode is  $1\mu\text{A}$  or less.
- 4) Built-in soft muting function for reducing pop at shut-down ON or OFF  
When a signal is present, its smooth envelope waveform is realized owing to this function.  
In addition, when no signal is present, pop generation is eliminated.  
A transit time can be adjusted easily through the use of an external capacitor.
- 5) Realization of high efficiency and low heat generation  
Efficiency = 80% (4W+4W ( $V_{CC}=9\text{V}$ ,  $R_L=8\Omega$ ) output can be made without using an external heat radiator.)  
A compact power package HTSSOP-B24 (7.8mm x 7.6mm) is employed.
- 6) Built-in function for reducing pop generation at disconnection from the outlet
- 7) Support of function for sampling frequency selection  
An internal PWM sampling frequency can be selected from three frequencies (200kHz, 250kHz and 300kHz).  
Countermeasures against interference (beat noise) due to a switching power source can be taken as needed.
- 8) Realization of high reliability  
Countermeasures against short-circuits due to output terminals shorted to  $V_{CC}$  or ground can be taken (support of automatic recovery).  
A temperature protection circuit is incorporated (support of automatic recovery).
- 9) Support of ERROR pin  
ERROR output takes place as a warning which indicates an error.  
(short-circuits due to output terminals shorted to  $V_{CC}$  or ground, or IC high temperature abnormality).



### ● Absolute maximum ratings

A circuit must be designed and evaluated not to exceed absolute maximum rating in any cases and even momentarily, to prevent reduction in functional performances and thermal destruction of a semiconductor product and secure useful life and reliability.

The following values assume  $T_a = 25^\circ\text{C}$ . For latest values, refer to delivery specifications.

| Parameter                     | Symbol | Ratings         | Unit | Conditions                          |
|-------------------------------|--------|-----------------|------|-------------------------------------|
| Supply voltage                | VCC    | +15             | V    | Pin 3, 5, 10, 12, 16, 21 (Note 1,2) |
| Power dissipation             | Pd     | 1.1             | W    | (Note 3)                            |
|                               |        | 2.8             | W    | (Note 4)                            |
| Input voltage for signal pin  | VIN    | -0.2 to Vcc+0.2 | V    | Pin 23, 24 (Note 1)                 |
| Input voltage for control pin | VCONT  | -0.2 to Vcc+0.2 | V    | Pin 14, 15 (Note 1)                 |
| Operating temperature range   | Topr   | -40 to +85      | °C   |                                     |
| Storage temperature range     | Tstg   | -55 to +150     | °C   |                                     |
| Maximum junction temperature  | Tjmax  | +150            | °C   |                                     |

(Note 1) A voltage that can be applied with reference to GND (pins 1, 7, 8, 13, 18 and 19)

(Note 2) Pd and Tjmax=150°C must not be exceeded.

(Note 3) 70mm × 70mm × 1.6mm FR4 One-sided glass epoxy board (Back copper foil 0%) installed.

If used under  $T_a=25^\circ\text{C}$  or higher, reduce 8.8 mW for increase of every 1°C. The board is provided with thermal via.

(Note 4) 70mm × 70mm × 1.6mm FR4 Both-sided glass epoxy board (Back copper foil 100%) installed.

If used under  $T_a=25^\circ\text{C}$  or higher, reduce 22.4 mW for increase of every 1°C. The board is provided with thermal via.

### ● Operating conditions

The temperature ( $T_a$ ) is  $25^\circ\text{C}$ . For the latest temperature, refer to the delivery specifications.

| Parameter       | Symbol | Ratings     | Unit | Conditions               |
|-----------------|--------|-------------|------|--------------------------|
| Supply voltage  | VCC    | +6 to +10.5 | V    | Pin 3, 5, 10, 12, 16, 21 |
| Load resistance | RL     | 6 to 16     | Ω    | (Note 5)                 |

(Note 5) This value must not exceed Pd.

### ● Electrical characteristics

Unless otherwise stated,  $T_a=25^\circ\text{C}$ ,  $V_{cc}=9\text{V}$ ,  $f_{in}=1\text{kHz}$ ,  $R_g=0\Omega$ ,  $R_L=8\Omega$ ,  $SDX="H"$  and  $FC="M (OPEN)"$  are assumed. For the latest values, refer to the delivery specifications.

| Parameter                                | Symbol | Limits     | Unit  | Conditions                                       |
|--|--------|------------|-------|--|
| Whole circuit                            |        |            |       |  |
| Circuit current 1 (sampling mode)        | ICC1   | 12         | mA    | No signal, no load                               |
| Circuit current 2 (mute mode)            | ICC2   | 1          | μA    | SDX = "L"  |
| Control                                  |        |            |       |  |
| Input voltage with SDX pin set to "H"    | VIHSDX | 2.5 to 9   | V     | Sampling state                                   |
| Input voltage with SDX pin set to "L"    | VILSDX | 0 to 0.5   | V     | Shut-down state                                  |
| Input voltage with FC pin set to "H"     | VIHFC  | 8.2 to 9   | V     | Setting of $F_s=300\text{kHz}$                   |
| Input voltage with FC pin set to "M"     | VIMFC  | 3.8 to 5.2 | V     | Setting of $F_s=250\text{kHz}$                   |
| Input voltage with FC pin set to "L"     | VILFC  | 0 to 0.8   | V     | Setting of $F_s=200\text{kHz}$                   |
| Audio output                             |        |            |       |  |
| Voltage gain                             | GV     | 30         | dB    | $P_o = 1\text{W}$                                |
| Maximum output power 1 (Note 6)          | PO1    | 4          | W     | THD+N = 10%, $R_L = 8\Omega$                     |
| Maximum output power 2 (Note 6)          | PO2    | 5          | W     | THD+N = 10%, $R_L = 6\Omega$                     |
| Total harmonic distortion ratio (Note 6) | THD    | 0.2        | %     | $P_o = 1\text{W}$ , BW=20Hz to 20kHz             |
| Crosstalk                                | CT     | 65         | dB    | $P_o = 1\text{W}$ , $R_g = 0\Omega$ , BW = IHF-A |
| Output noise voltage (sampling mode)     | VNO    | 90         | μVrms | $R_g = 0\Omega$ , BW = IHF-A                     |
| Residual noise voltage (mute mode)       | VNOM   | 1          | μVrms | $R_g = 0\Omega$ , BW = IHF-A, MUTEX = "L"        |
| Internal sampling clock frequency        | Fs     | 200        | kHz   | FC = L<br>FC = M(OPEN)<br>FC = H                 |
|  |        | 250        |       |  |
|  |        | 300        |       |  |

(Note 6) The rated values of items above indicate average performances of the device, which largely depend on circuit layouts, components, and power supplies. The reference values are those applicable to the device and components directly installed on a board specified by us.

●Electrical characteristic curves (Ta=25°C) (Reference data)

(1) Under Stereo Operation (RL=8Ω)

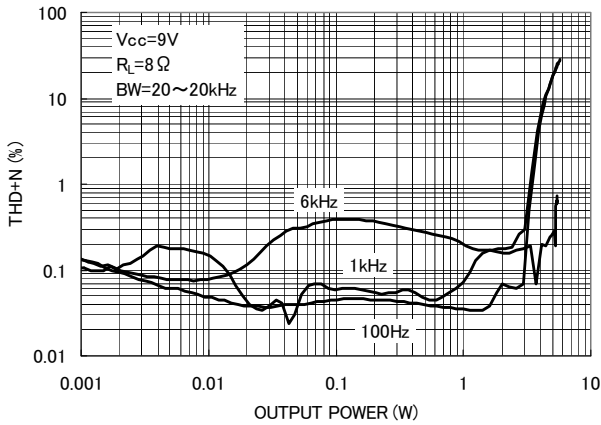

Fig. 1 THD+N - Output Power

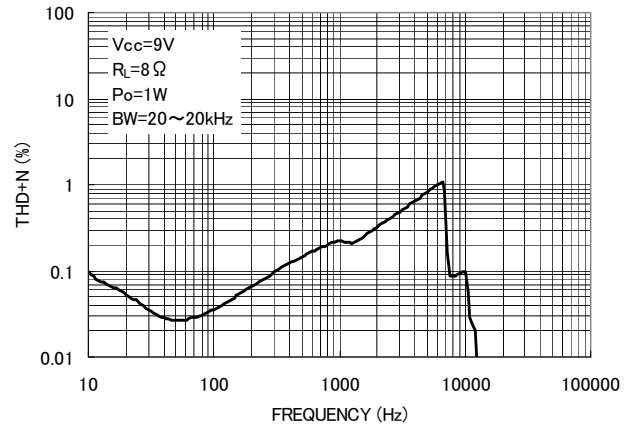

Fig. 2 THD+N - Frequency

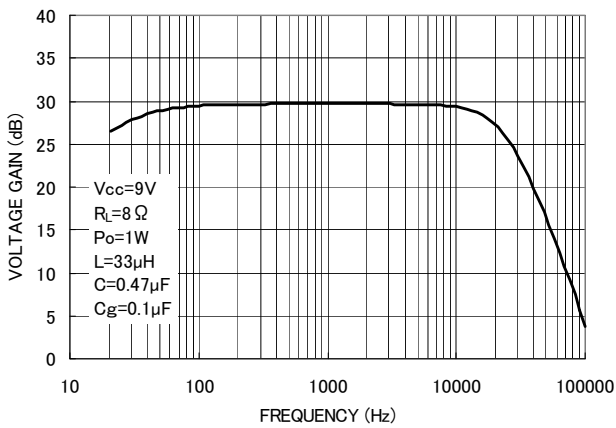

Fig. 3 Voltage Gain - Frequency

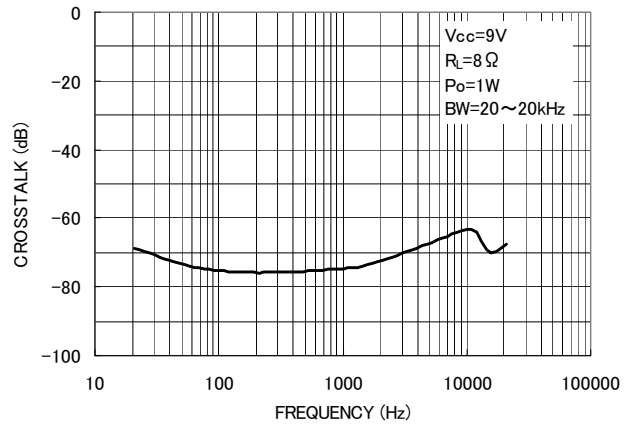

Fig. 4 Crosstalk - Frequency

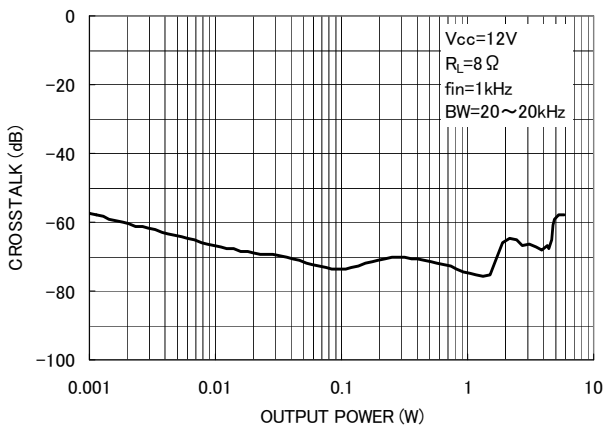

Fig. 5 Crosstalk - Output Power

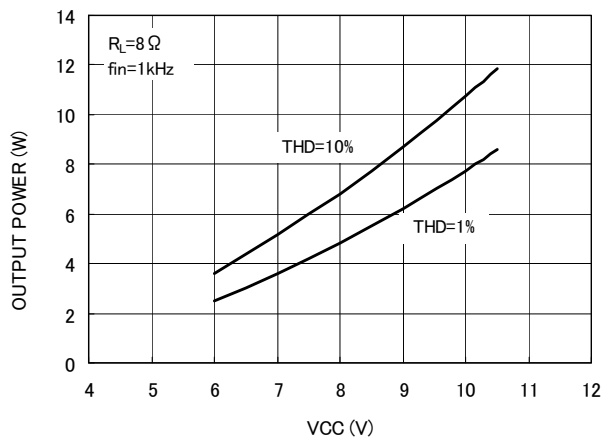

Fig. 6 Output Power - Supply Voltage

●Electrical characteristic curves (Reference data) – Continued

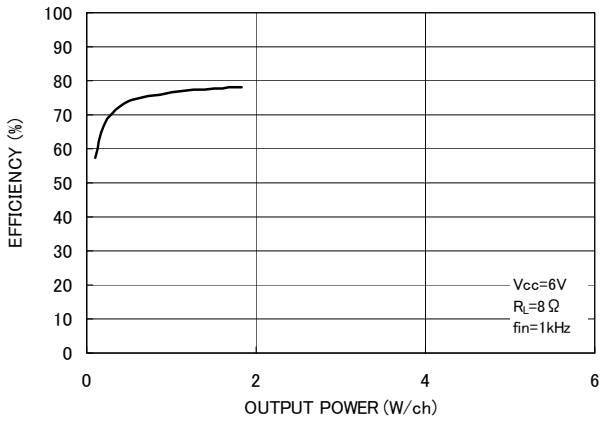

Fig. 7 Efficiency - Output Power

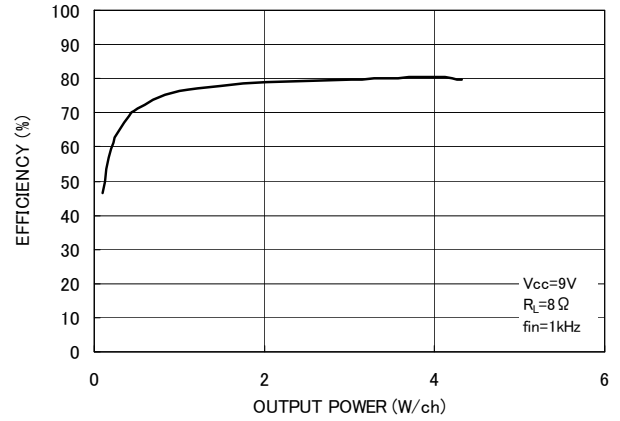

Fig. 8 Efficiency - Output Power

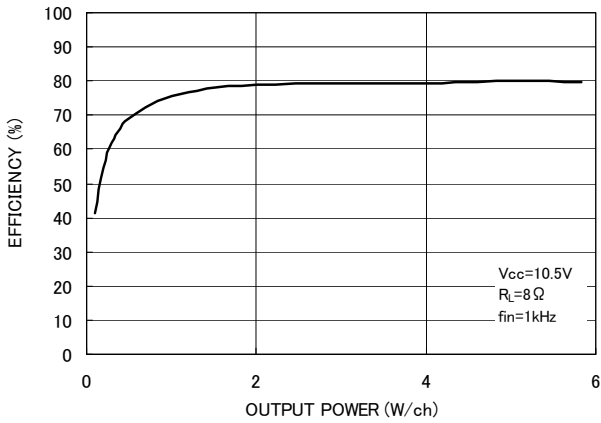

Fig. 9 Efficiency - Output Power

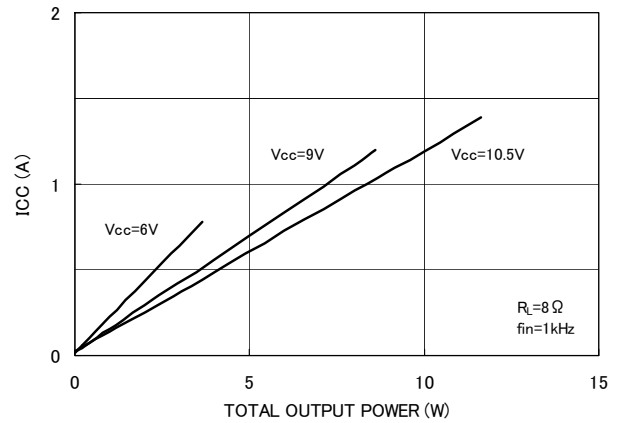

Fig. 10 Current Consumption - Output Power

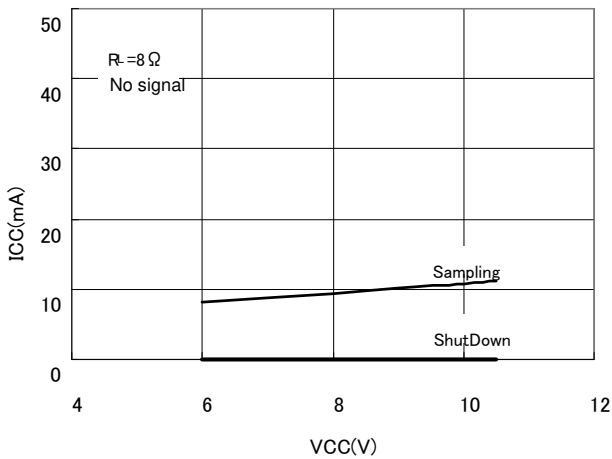

Fig. 11 50 Current Consumption - Supply Voltage

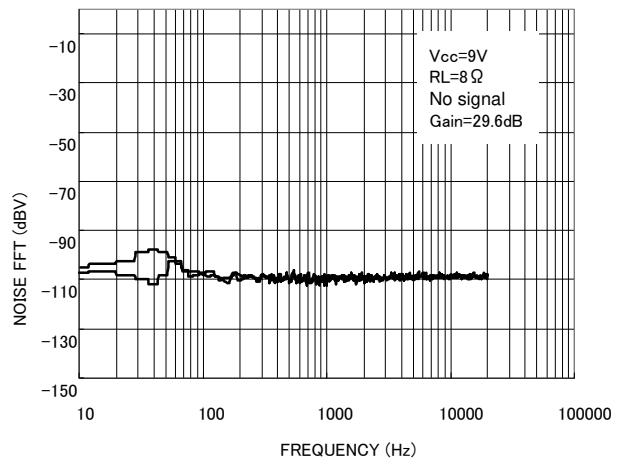

Fig. 12 Output Noise Voltage FFT

●Electrical characteristic curves (Reference data) – Continued

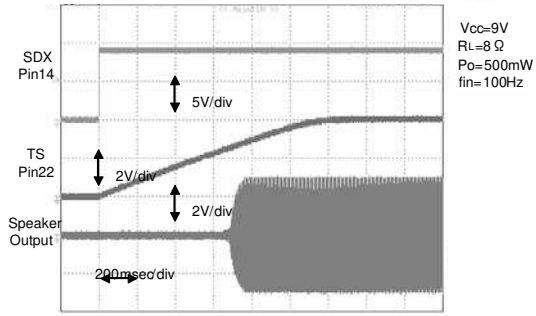

Fig. 13 Waveform at Soft Mute Reset

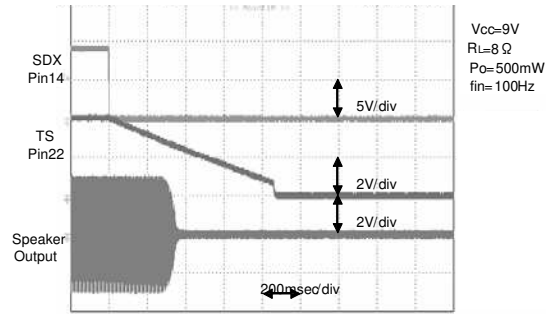

Fig. 14 Waveform at Soft Mute

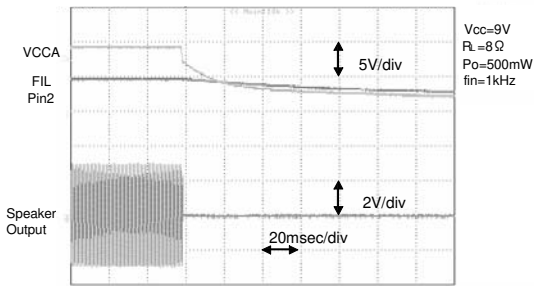

Fig. 15 Waveform at Instantaneous Power Interruption (20msec/div)

●Electrical characteristic curves (Reference data) – Continued

(2) Under Stereo Operation ( $R_L=16\ \Omega$ )

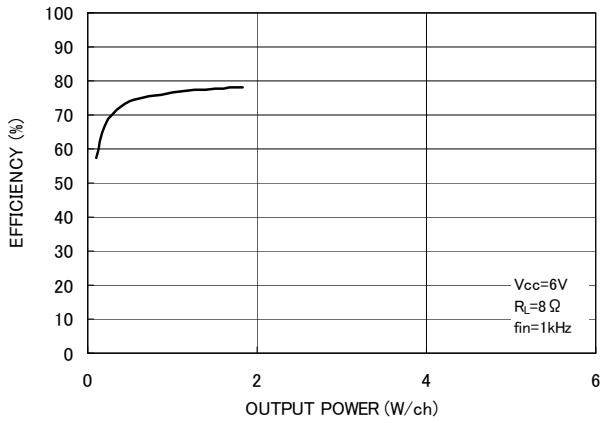

Fig. 16 Output Power - Supply Voltage

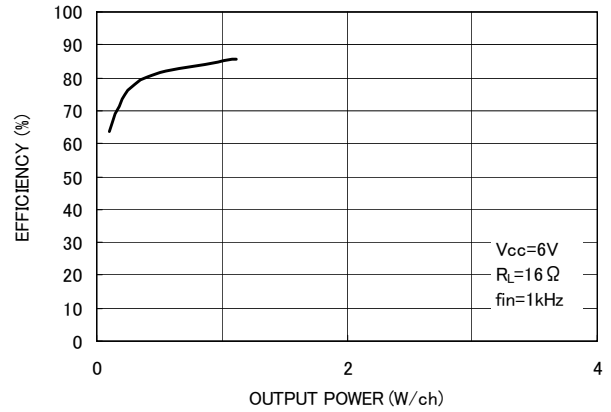

Fig. 17 Efficiency - Output Power

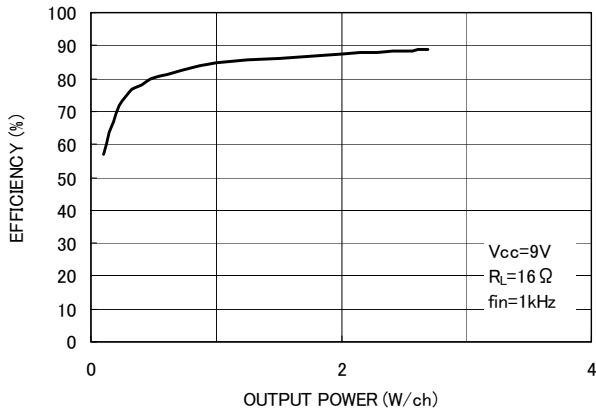

Fig. 18 Efficiency - Output Power

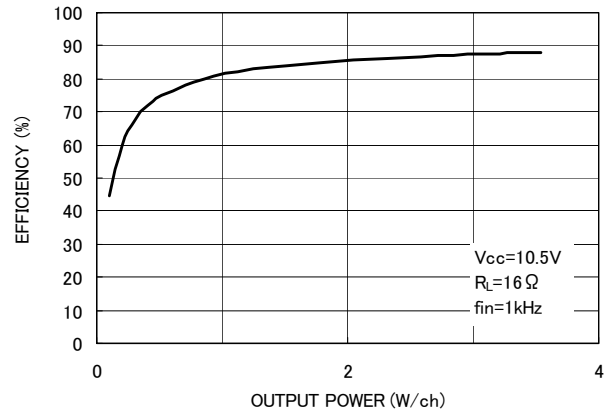

Fig. 19 Efficiency - Output Power

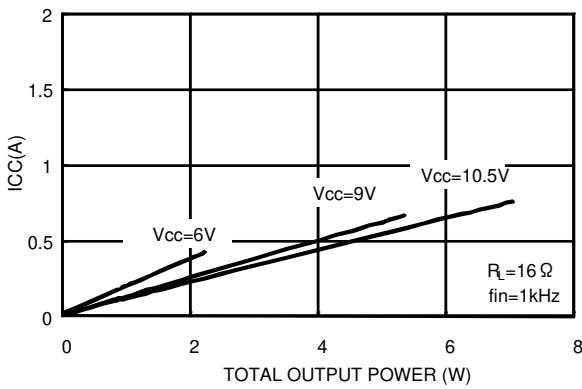

Fig. 20 Current Consumption - Output Power

●Electrical characteristic curves (Reference data) – Continued

(3) Under Stereo Operation ( $R_L=6\Omega$ )

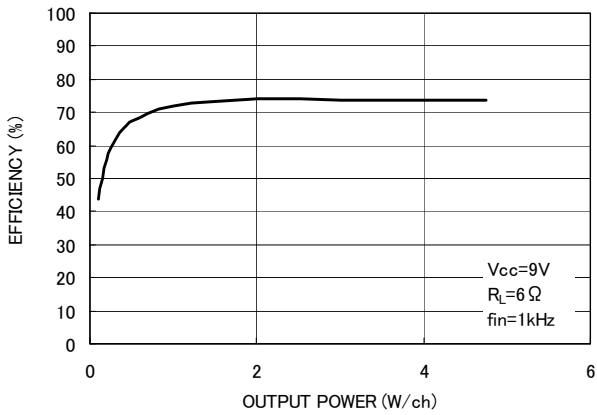

Fig. 21 Output Power - Supply Voltage

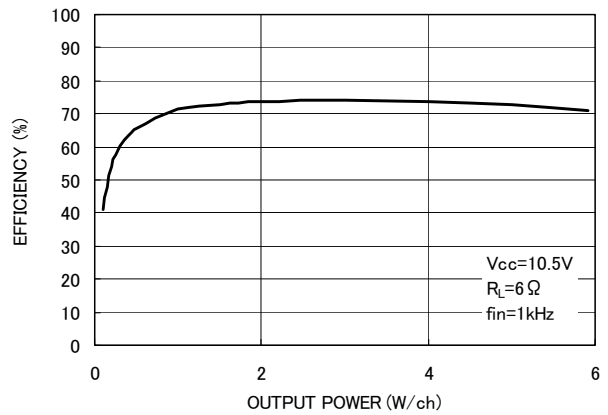

Fig. 22 Efficiency - Output Power

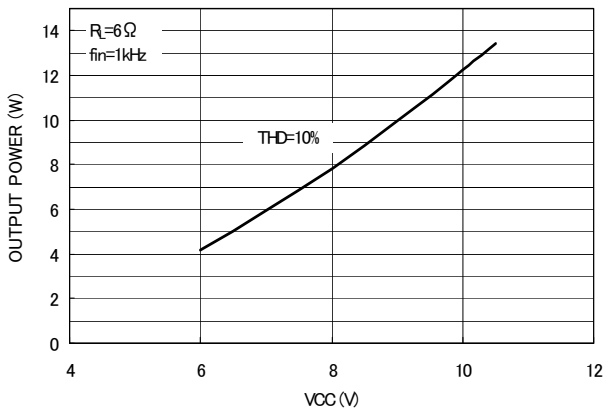

Fig. 23 Efficiency - Output Power

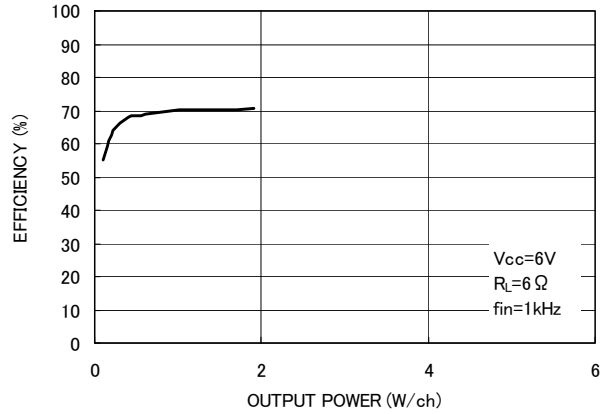

Fig. 24 Efficiency - Output Power

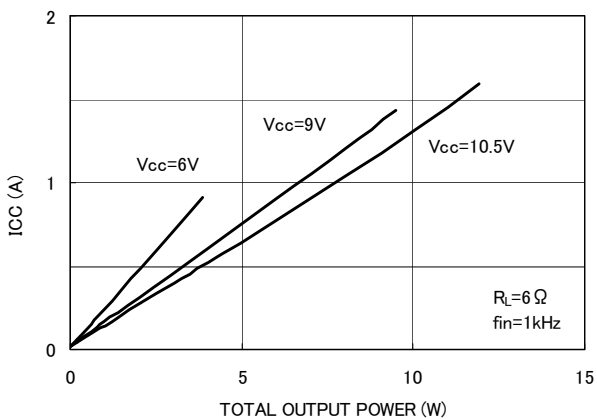

Fig. 25 Current Consumption - Output Power



●Pin Assignment Diagram

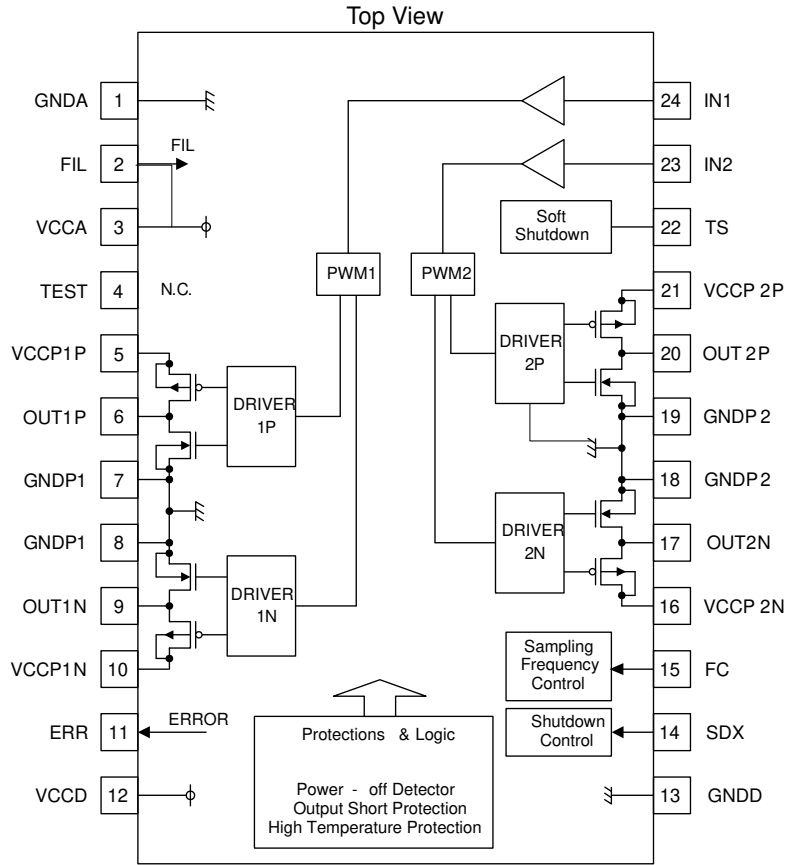

Fig. 26 Pin Assignment

●Outer Dimensions and Inscriptions

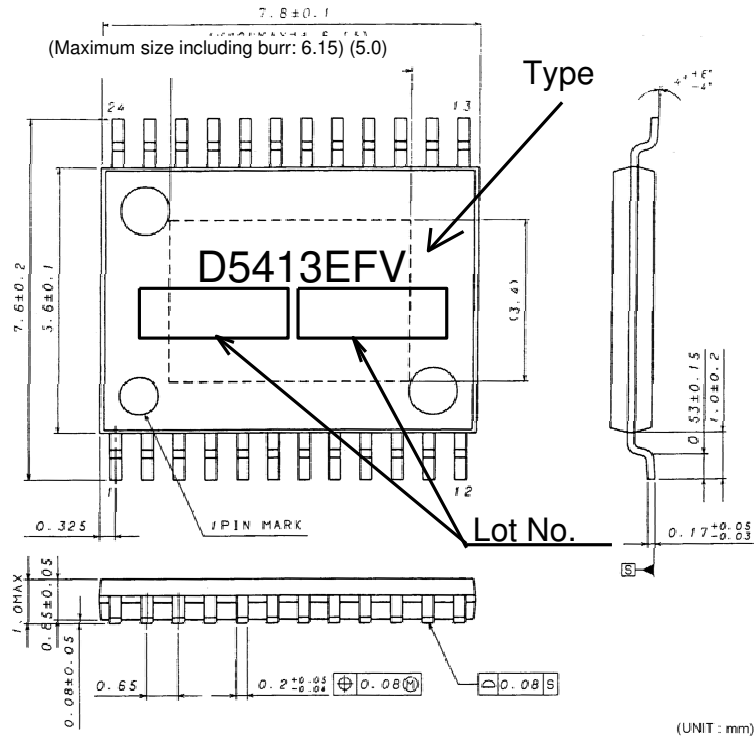

Fig. 27 Outer Dimensions and Inscriptions of the HTSSOP-B24 Package

●Pin configuration (Pin Voltage: Typical Value)

| No.      | Symbol     | Pin voltage           | Pin description  | Internal equalizing circuit |
|----------|------------|-----------------------|--|-----------------------------|
| 24<br>23 | IN1<br>IN2 | 1/2V <sub>CC</sub>    | ch1: Analog signal input pin<br>ch2: Analog signal input pin<br><br>Input an audio signal via a capacitor. |                             |
| 5        | VCCP1P     | V <sub>CC</sub>       | ch1: Positive power system power supply pin  |                             |
| 6        | OUT1P      | V <sub>CC</sub> to 0V | ch1: Positive PWM signal output pin<br>Make connection to the output LPF.                                  |                             |
| 7, 8     | GNDP1      | 0V                    | ch1: Power GND pin   |                             |
| 9        | OUT1N      | V <sub>CC</sub> to 0V | ch1: Negative PWM signal output pin<br>Make connection to the output LPF.                                  |                             |
| 10       | VCCP1N     | V <sub>CC</sub>       | ch1: Negative power system power supply pin  |                             |
| 11       | ERROR      | H: 5V<br>L: 0V        | Error output pin<br><br>Pin for notifying an operation error<br>H: Error<br>L: Normal operation            |                             |
| 12       | VCCD       | V <sub>CC</sub>       | Control power supply pin   |                             |
| 13       | GNDD       | 0V                    | Control GND pin  |                             |
| 14       | SDX        | -                     | Shut-down control pin<br><br>H: Shut-down OFF<br>L: Shut-down ON   |                             |

●Pin configuration - Continued

| No.    | Symbol | Pin voltage           | Pin description  | Internal equalizing circuit |
|--------|--------|-----------------------|--|-----------------------------|
| 4      | TEST   | V <sub>CC</sub>       | Do not use the TEST pin.<br>Keep this pin open or connect it to V <sub>CC</sub> for regular use. |                             |
| 22     | TS     | 0 to 4V               | Shut-down ON/OFF<br>Constant setting pin<br><br>Connect a capacitor.                             |                             |
| 16     | VCCP2N | V <sub>CC</sub>       | ch2: Negative power system power supply pin  |                             |
| 17     | OUT2N  | V <sub>CC</sub> to 0V | ch2: Negative PWM signal output pin<br>Make connection to the output LPF.                        |                             |
| 18, 19 | GNDP2  | 0V                    | ch2: Power GND pin   |                             |
| 20     | OUT2P  | V <sub>CC</sub> to 0V | ch2: Positive PWM signal output pin<br>Make connection to the output LPF.                        |                             |
| 21     | VCCP2P | V <sub>CC</sub>       | ch2: Positive power system power supply pin  |                             |
| 3      | VCCA   | V <sub>CC</sub>       | Analog system power supply pin   |                             |
| 2      | FILA   | 1/2V <sub>CC</sub>    | Analog signal system bias pin<br><br>Connect a capacitor.  |                             |
| 1      | GND A  | 0V                    | Analog signal system GND pin   |                             |

●Application Circuit Diagram

(1)Application Circuit Diagram with a Load of 8Ω for Stereo Operation

• Vcc=6V to 10.5V

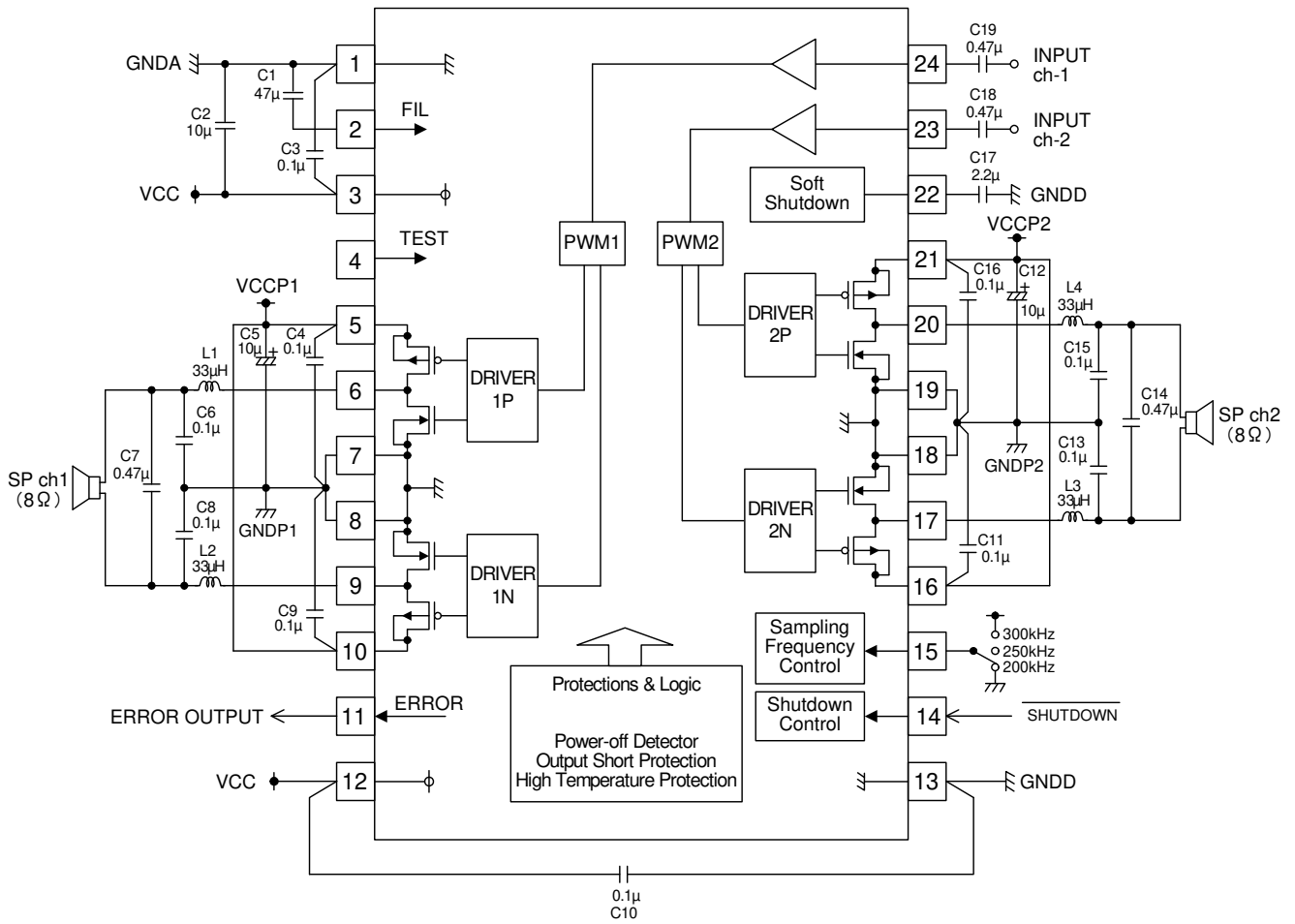

Fig.28 Circuit Diagram with a Load of 8Ω for Stereo Operation

## (2)BOMs of Boards for Stereo Operation

Table 1 BOMs of Boards with Loads of 8Ω, 6Ω and 16Ω for Stereo Operation

| No. | Item | Part Number        | Vendor    | Configuration |      | Value  | Rated voltage | Tolerance | Temperature characteristics | Quantity | Reference                 |
|-----|------|--------------------|-----------|---------------|------|--------|---------------|-----------|-----------------------------|----------|---------------------------|
|     |      |                    |           | mm            | inch |        |               |           |                             |          |                           |
| 1   | IC   | BD5413EFV          | ROHM      | HTSSOP-B24    |      | -      | -             | -         | -                           | 1        | IC1                       |
| 2   | C    | GRM32EB31A476KE20  | MURATA    | 3225          | 1210 | 47μF   | 10V           | ±10%      | ±10%                        | 1        | C1                        |
| 3   | C    | GRM21BB31C106KE15  | MURATA    | 2012          | 0805 | 10μF   | 16V           | ±10%      | ±10%                        | 1        | C2                        |
| 4   | C    | GRM188B11C104KA01  | MURATA    | 1608          | 0603 | 0.1μF  | 16V           | ±10%      | ±10%                        | 6        | C3, C4, C9, C10, C11, C16 |
| 5   | C    | GRM188B30J225KE18  | MURATA    | 1608          | 0603 | 2.2μF  | 6.3V          | ±10%      | ±10%                        | 1        | C17                       |
| 6   | C    | GRM188B11C474KA87  | MURATA    | 1608          | 0603 | 0.47μF | 16V           | ±10%      | ±10%                        | 2        | C18, C19                  |
| 7   | C    | EMZA350ADA100ME61G | CHEM1-00N | 5.3×5.3       |      | 10μF   | 35V           | ±20%      | +20%, -25%                  | 2        | C5, C12                   |

## BOM of Board with a Load Resistance of 8Ω

| No. | Item | Part Number       | Vendor | Configuration |      | Value  | Rated voltage | Tolerance | Temperature characteristics | Quantity | Reference        |
|-----|------|-------------------|--------|---------------|------|--------|---------------|-----------|-----------------------------|----------|------------------|
|     |      |                   |        | mm            | inch |        |               |           |                             |          |                  |
| 8   | C    | GRM188B11C104KA01 | MURATA | 1608          | 0603 | 0.1μF  | 16V           | ±10%      | ±10%                        | 4        | C6, C8, C13, C15 |
| 9   | C    | GRM188B11C474KA87 | MURATA | 1608          | 0603 | 0.47μF | 16V           | ±10%      | ±10%                        | 2        | C7, C14          |

| No. | Item | Part Number          | Vendor | Configuration |  | Value | Tolerance | DC Resistance | Rated DC Current | Quantity | Reference      |
|-----|------|----------------------|--------|---------------|--|-------|-----------|---------------|------------------|----------|----------------|
|     |      |                      |        | mm            |  |       |           |               |                  |          |                |
| 10  | L    | TSL0808RA-330K1R4-PF | TDK    | Φ8.5, 8.3     |  | 33μH  | ±10%      | 92mΩmax       | 1.4A max         | 4        | L1, L2, L3, L4 |

## BOM of Board with a Load Resistance of 6Ω

| No. | Item | Part Number       | Vendor | Configuration |      | Value  | Rated voltage | Tolerance | Temperature characteristics | Quantity | Reference        |
|-----|------|-------------------|--------|---------------|------|--------|---------------|-----------|-----------------------------|----------|------------------|
|     |      |                   |        | mm            | inch |        |               |           |                             |          |                  |
| 8   | C    | GRM188B11C474KA87 | MURATA | 1608          | 0603 | 0.47μF | 16V           | ±10%      | ±10%                        | 4        | C6, C8, C13, C15 |
| 9   | C    | GRM188B11C474KA87 | MURATA | 1608          | 0603 | 0.47μF | 16V           | ±10%      | ±10%                        | 2        | C7, C14          |

| No. | Item | Part Number          | Vendor | Configuration |  | Value | Tolerance | DC Resistance | Rated DC Current | Quantity | Reference      |
|-----|------|----------------------|--------|---------------|--|-------|-----------|---------------|------------------|----------|----------------|
|     |      |                      |        | mm            |  |       |           |               |                  |          |                |
| 10  | L    | TSL0808RA-220K1R7-PF | TDK    | Φ8.5, 8.3     |  | 22μH  | ±10%      | 70mΩmax       | 1.7A max         | 4        | L1, L2, L3, L4 |

## BOM of Board with a Load Resistance of 16Ω

| No. | Item | Part Number       | Vendor | Configuration |      | Value  | Rated voltage | Tolerance | Temperature characteristics | Quantity | Reference        |
|-----|------|-------------------|--------|---------------|------|--------|---------------|-----------|-----------------------------|----------|------------------|
|     |      |                   |        | mm            | inch |        |               |           |                             |          |                  |
| 8   | C    | GRM188B11C104KA01 | MURATA | 1608          | 0603 | 0.01μF | 16V           | ±10%      | ±10%                        | 4        | C6, C8, C13, C15 |
| 9   | C    | GRM188B11C224KA01 | MURATA | 1608          | 0603 | 0.22μF | 16V           | ±10%      | ±10%                        | 2        | C7, C14          |

| No. | Item | Part Number          | Vendor | Configuration |  | Value | Tolerance | DC Resistance | Rated DC Current | Quantity | Reference      |
|-----|------|----------------------|--------|---------------|--|-------|-----------|---------------|------------------|----------|----------------|
|     |      |                      |        | mm            |  |       |           |               |                  |          |                |
| 10  | L    | TSL0808RA-680K1R0-PF | TDK    | Φ8.5, 8.3     |  | 68μH  | ±10%      | 160mΩmax      | 1A max           | 4        | L1, L2, L3, L4 |



### ●Notes for use

#### 1. About absolute maximum ratings

If an applied voltage or an operating temperature exceeds an absolute maximum rating, it may cause destruction of a device. A result of destruction, whether it is short mode or open mode, is not predictable. Therefore, provide a physical safety measure such as fuse, against a special mode that may violate conditions of absolute maximum ratings.

#### 2. About power supply line

As return of current regenerated by back EMF of output coil happens, take steps such as putting capacitor between power supply and GND as a electric pathway for the regenerated current. Be sure that there is no problem with each property such as emptied capacity at lower temperature regarding electrolytic capacitor to decide capacity value. If the connected power supply does not have sufficient current absorption capacity, regenerative current will cause the voltage on the power supply line to rise, which combined with the product and its peripheral circuitry may exceed the absolute maximum ratings. It is recommended to implement a physical safety measure such as the insertion of a voltage clamp diode between the power supply and GND pins.

#### 3. Potential of GND (1, 7, 8, 13, 18 and 19 pins)

Potential of the GND terminal must be the lowest under any operating conditions.

#### 4. About thermal design

Perform thermal design with sufficient margins, in consideration of maximum power dissipation  $P_d$  under actual operating conditions. This product has an exposed frame on the back of the package, and it is assumed that the frame is used with measures to improve efficiency of heat dissipation. In addition to front surface of board, provide a heat dissipation pattern as widely as possible on the back also.

A class-D power amplifier has heat dissipation efficiency far higher than that of conventional analog power amplifier and generates less heat. However, extra attention must be paid in thermal design so that a power dissipation  $P_{diss}$  should not exceed the maximum power dissipation  $P_d$ .

$$\text{Maximum power dissipation} \quad P_d = P_o \frac{T_{jmax} - T_a}{\theta_{ja}} \quad [W]$$

$$\text{Power dissipation} \quad P_{diss} = P_o \left( \frac{1}{\eta} - 1 \right) \quad [W]$$

$T_{jmax}$ : Maximum temperature junction = 150[°C]

$T_a$ : Operating ambient temperature [°C]

$\theta_{ja}$ : Package thermal resistance [°C/W]

$P_o$ : Output power [W]

$\eta$ : Efficiency

#### 5. About operations in strong electric field

Note that the device may malfunction in a strong electric field.

#### 6. Thermal shutdown (TSD) circuit

This product is provided with a built-in thermal shutdown circuit. When the thermal shutdown circuit operates, the output transistors are placed under open status. The thermal shutdown circuit is primarily intended to shut down the IC avoiding thermal runaway under abnormal conditions with a chip temperature exceeding  $T_{jmax} = 150^\circ\text{C}$ , and is not intended to protect and secure an electrical appliance. Accordingly, do not use this circuit function to protect a customer's electrical appliance.

#### 7. About shorting between pins and installation failure

Be careful about direction and displacement of an IC when installing it onto the board. Faulty installation may destroy the IC when the device is energized. In addition, a foreign matter getting in between IC pins, pins and power supply, and pins and GND may cause shorting and destruction of the IC.

#### 8. About power-on or power-off sequence

Set the SDX pin (pin 14) to "L" level before initiating the power-on sequence. Similarly, set the SDX pin (pin 14) to "L" level before initiating the power-off sequence. If such a setting is made, pop reduction is achieved at power-on or power-off sequence. In addition, note that all power supply pins shall be made active or inactive at the same time.

#### 9. About error output pin (pin 11)

When a high temperature protection function or VCC/GND shorting protection function is activated, an error flag is output via an error output pin. Because the error output pin is primarily intended to indicate the state of BD5413EFV and is available only to protect BD5413EFV, it cannot be used for any other purposes.

#### 10. About TEST pin (pin 4)

Do not use the TEST pin. Keep this pin open or connect it to VCC for regular use.

●Ordering part number

|   |   |
|---|---|
| B | D |
|---|---|

Part No  
BD.

|   |   |   |   |
|---|---|---|---|
| 5 | 4 | 1 | 3 |
|---|---|---|---|

Part No.  
5413

|   |   |   |
|---|---|---|
| E | F | V |
|---|---|---|

Package  
EFV:HTSSOP-B24

|   |   |
|---|---|
| E | 2 |
|---|---|

Packaging and forming specification  
E2: Embossed tape and reel

HTSSOP-B24

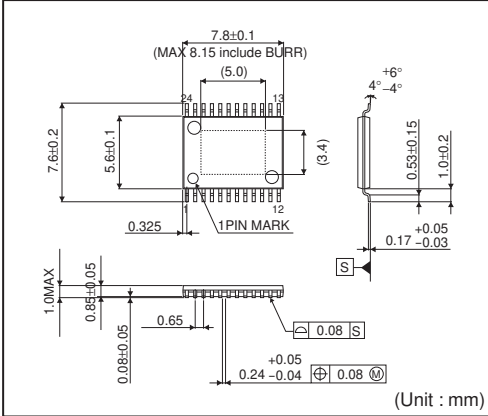

<Tape and Reel information>

|                   |  |
|-------------------|--|
| Tape              | Embossed carrier tape (with dry pack)  |
| Quantity          | 2000pcs  |
| Direction of feed | E2<br>( The direction is the 1 pin of product is at the upper left when you hold reel on the left hand and you pull out the tape on the right hand ) |

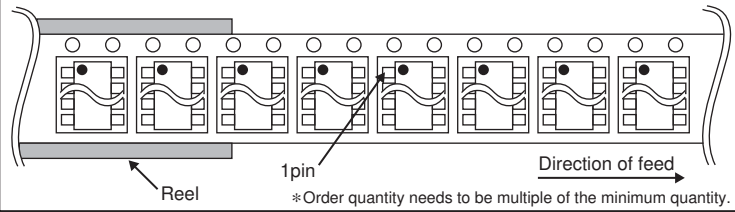

## Notes

No copying or reproduction of this document, in part or in whole, is permitted without the consent of ROHM Co.,Ltd.

The content specified herein is subject to change for improvement without notice.

The content specified herein is for the purpose of introducing ROHM's products (hereinafter "Products"). If you wish to use any such Product, please be sure to refer to the specifications, which can be obtained from ROHM upon request.

Examples of application circuits, circuit constants and any other information contained herein illustrate the standard usage and operations of the Products. The peripheral conditions must be taken into account when designing circuits for mass production.

Great care was taken in ensuring the accuracy of the information specified in this document. However, should you incur any damage arising from any inaccuracy or misprint of such information, ROHM shall bear no responsibility for such damage.

The technical information specified herein is intended only to show the typical functions of and examples of application circuits for the Products. ROHM does not grant you, explicitly or implicitly, any license to use or exercise intellectual property or other rights held by ROHM and other parties. ROHM shall bear no responsibility whatsoever for any dispute arising from the use of such technical information.

The Products specified in this document are intended to be used with general-use electronic equipment or devices (such as audio visual equipment, office-automation equipment, communication devices, electronic appliances and amusement devices).

The Products specified in this document are not designed to be radiation tolerant.

While ROHM always makes efforts to enhance the quality and reliability of its Products, a Product may fail or malfunction for a variety of reasons.

Please be sure to implement in your equipment using the Products safety measures to guard against the possibility of physical injury, fire or any other damage caused in the event of the failure of any Product, such as derating, redundancy, fire control and fail-safe designs. ROHM shall bear no responsibility whatsoever for your use of any Product outside of the prescribed scope or not in accordance with the instruction manual.

The Products are not designed or manufactured to be used with any equipment, device or system which requires an extremely high level of reliability the failure or malfunction of which may result in a direct threat to human life or create a risk of human injury (such as a medical instrument, transportation equipment, aerospace machinery, nuclear-reactor controller, fuel-controller or other safety device). ROHM shall bear no responsibility in any way for use of any of the Products for the above special purposes. If a Product is intended to be used for any such special purpose, please contact a ROHM sales representative before purchasing.

If you intend to export or ship overseas any Product or technology specified herein that may be controlled under the Foreign Exchange and the Foreign Trade Law, you will be required to obtain a license or permit under the Law.



Thank you for your accessing to ROHM product informations.  
More detail product informations and catalogs are available, please contact us.

## ROHM Customer Support System

<http://www.rohm.com/contact/>