



Chipsmall Limited consists of a professional team with an average of over 10 year of expertise in the distribution of electronic components. Based in Hongkong, we have already established firm and mutual-benefit business relationships with customers from,Europe,America and south Asia,supplying obsolete and hard-to-find components to meet their specific needs.

With the principle of “Quality Parts,Customers Priority,Honest Operation,and Considerate Service”,our business mainly focus on the distribution of electronic components. Line cards we deal with include Microchip,ALPS,ROHM,Xilinx,Pulse,ON,Everlight and Freescale. Main products comprise IC,Modules,Potentiometer,IC Socket,Relay,Connector.Our parts cover such applications as commercial,industrial, and automotives areas.

We are looking forward to setting up business relationship with you and hope to provide you with the best service and solution. Let us make a better world for our industry!



Contact us

Tel: +86-755-8981 8866 Fax: +86-755-8427 6832

Email & Skype: info@chipsmall.com Web: www.chipsmall.com

Address: A1208, Overseas Decoration Building, #122 Zhenhua RD., Futian, Shenzhen, China



Middle Power Class-D Speaker Amplifiers



Analog Input / Single End Output Class-D Speaker Amplifier

BD5445EFV

No.11075ECT16

●Overview

BD5445EFV is a Analog input type Class D Speaker Amplifier designed for Flat-panel TVs in particular for space-saving and low-power consumption, delivers an output power of 17W+17W. This IC employs state-of-the-art Bipolar, CMOS, and DMOS (BCD) process technology that eliminates turn-on resistance in the output power stage and internal loss due to line resistances up to an ultimate level. With this technology, the IC can achieve high efficiency of 91% (10W+10W output with 8Ω load). In addition, the IC is packaged in a compact reverse heat radiation type power package to achieve low power consumption and low heat generation and eliminates necessity of external heat-sink up to a total output power of 34W. This product satisfies both needs for drastic downsizing, low-profile structures and powerful, high-quality playback of sound system.

●Features

- 1) 17W stereo single-ended outputs
34W mono bridge-tied-load output
- 2) Wide supply voltage (From 10V to 27V)
- 3) Four selectable gain (14, 20, 26, 32dB)
- 4) Master / Slave function
- 5) Soft-start and Soft-mute
- 6) Low noise, Low distortion
- 7) Various protection functions
(High temperature, Output short, Under voltage)
- 8) Small power package (HTSSOP-B28)

●Applications

Flat Panel TVs (LCD, Plasma), Home Audio, Desktop PC, Amusement equipments, Electronic Music equipments, etc.

● Absolute maximum ratings (Ta=25°C)

Item	Symbol	Limit	Unit	Conditions
Supply voltage	V _{CC}	30	V	Pin 1, 15, 16, 27, 28 ※1 ※2
Power dissipation	P _d	1.45	W	※3
		3.30	W	※4
		4.70	W	※5
Input voltage for signal	V _{IN}	-0.3 ~ 5.3	V	Pin 4, 5 ※1
Input voltage for control	V _{CONT}	-0.3 ~ V _{CC} + 0.3	V	Pin 2, 3, 10, 11, 13 ※1
Input voltage for clock	V _{OSC}	-0.3 ~ 5.3	V	Pin 12 ※1
Operating temperature range	T _{opr}	-25 ~ +85	°C	
Storage temperature range	T _{stg}	-55 ~ +150	°C	
Maximum junction temperature	T _{jmax}	+150	°C	

※1 The voltage that can be applied, based on Gnd(Pin6, 20, 21, 22, 23)

※2 Do not, however exceed P_d and T_{jmax}=150°C.

※3 70mm × 70mm × 1.6mm, FR4, 1-layer glass epoxy board (Copper on bottom layer 0%)

Derating in done at 11.6mW/°C for operating above Ta=25°C.

※4 70mm × 70mm × 1.6mm, FR4, 2-layer glass epoxy board (Copper on bottom layer 100%)

Derating in done at 26.4mW/°C for operating above Ta=25°C. There are thermal via on the board.

※5 70mm × 70mm × 1.6mm, FR4, 4-layer glass epoxy board (Copper on bottom layer 100%)

Derating in done at 37.6mW/°C for operating above Ta=25°C. There are thermal via on the board.

● Operating conditions (Ta=25°C)

Item	Symbol	Limit	Unit	Conditions
Supply voltage	V _{CC}	10 ~ 27	V	Pin 1, 15, 16, 27, 28 ※1 ※2
Minimum load impedance	R _L	3.6	Ω	※6

※6 Do not, however exceed P_d.

※ No radiation-proof design

●Electrical characteristics (Unless otherwise specified Ta=25°C, Vcc=24V, f=1kHz, R_L=8Ω, Po=1W, Gain=20dB, PDX=24V, MUTEX=24V, MS=0V, Single-ended outputs)

Item	Symbol	Limit			Unit	Conditions
		Min	Typ	Max		
Whole circuit						
Circuit current 1	I _{CC1}	-	25	50	mA	Pin 1, 15, 16, 27, 28 No load, No signal
Circuit current 2 (Power down mode)	I _{CC2}	-	2	4	mA	Pin 1, 15, 16, 27, 28 PDX=0V, MUTEX=0V, No load, No signal
Control circuit						
High level input voltage for control	V _{IH}	2.5	-	24	V	Pin 2, 3, 10, 11, 13
Low level input voltage for control	V _{IL}	0	-	0.8	V	Pin 2, 3, 10, 11, 13
High level input voltage for clock	V _{IHC}	2.5	-	5	V	Pin 12
Low level input voltage for clock	V _{ILC}	0	-	0.8	V	Pin 12
Audio circuit						
Momentary maximum output power	P _{O1}	-	10	-	W	R _L =8Ω, THD+n=10% ※7
	P _{O2}	-	17	-		R _L =4Ω, THD+n=10% ※7
Voltage gain	G _{V0}	12	14	16	dB	Gain1=0V, Gain0=0V ※7
	G _{V1}	18	20	22		Gain1=0V, Gain0=24V ※7
	G _{V2}	24	26	28		Gain1=24V, Gain0=0V ※7
	G _{V3}	30	32	34		Gain1=24V, Gain0=24V ※7
Total harmonic distortion	THD	-	0.05	-	%	BW=20~20kHz ※7
Crosstalk	CT	60	75	-	dB	Rg=0Ω, BW=IHF-A ※7
Output noise voltage	V _{NO}	-	80	160	μVrms	Rg=0Ω, BW=IHF-A ※7
Residual noise voltage (Power down mode)	V _{NOR}	-	1	10	μVrms	PDX=0V, MUTEX=0V Rg=0Ω, BW=IHF-A ※7
Mute attenuation	G _{VM}	80	94	-	dB	MUTEX=0V, BW= IHF-A ※7
Power supply rejection ratio	PSRR	-	60	-	dB	Vripple=1Vrms, BW= IHF-A Rg=0Ω, fripple=100Hz ※7
Internal oscillation frequency	F _{OSC}	480	600	720	kHz	Pin 12, MS=0V ※7
External clock frequency	F _{EXT}	480	-	720	kHz	Pin 12, MS=24V ※7

※7 These items show the typical performance of device and depend on board layout, parts, power supply.
The standard value is in mounting device and parts on surface of ROHM's board directly.

● Typical Characteristics Data (SE × 2ch) Measured on ROHM's evaluation board.

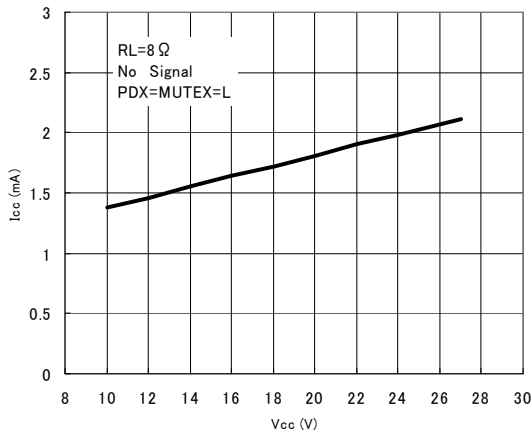

Fig. 1 Power supply voltage—Current consumption

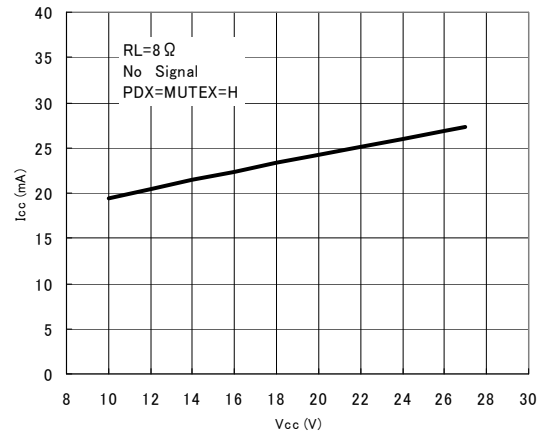

Fig. 2 Power supply voltage—Current consumption

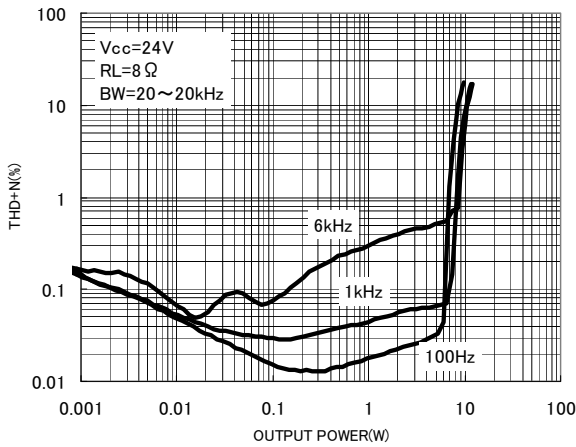

Fig.3 Output power—THD+N

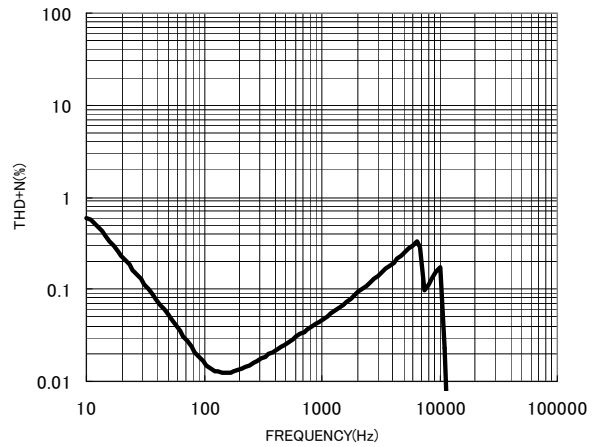

Fig.4 Frequency—THD+N

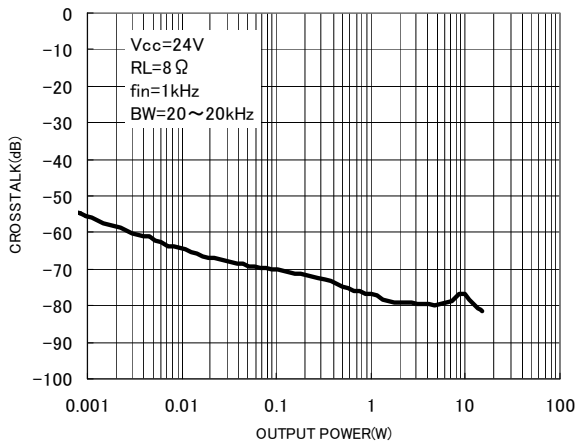

Fig.5 Output power—Crosstalk

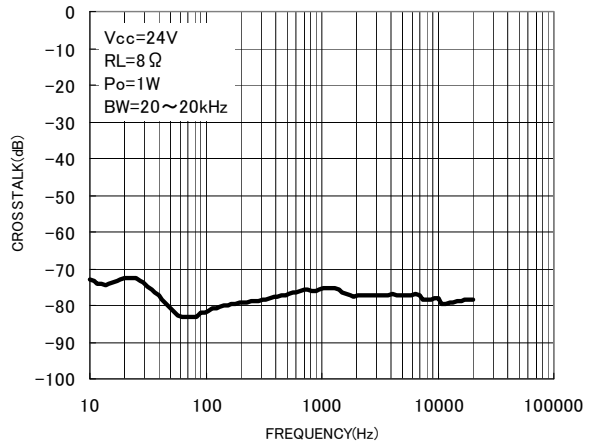

Fig.6 Frequency—Crosstalk

● Typical Characteristics Data (SE × 2ch) Measured on ROHM's evaluation board.

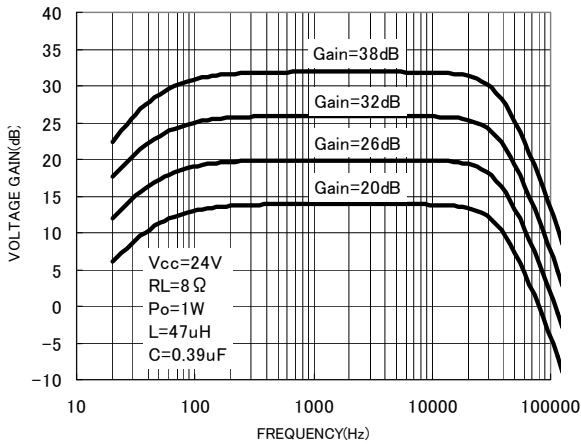

Fig.7 Frequency–Voltage gain

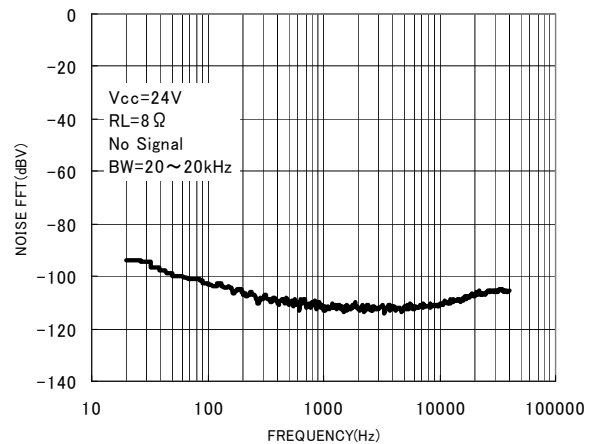

Fig.8 FFT of Output Noise Voltage

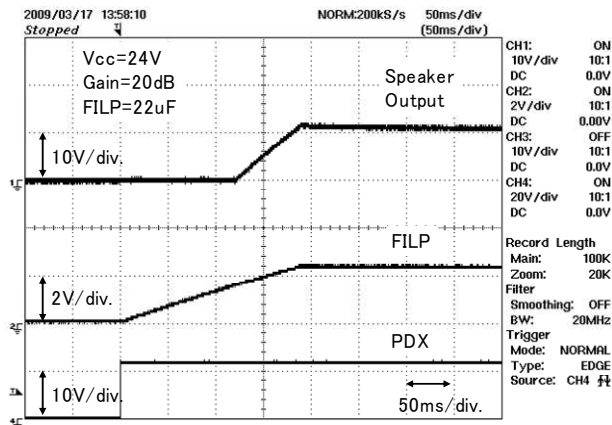

Fig.9 Waveform when releasing Power-down

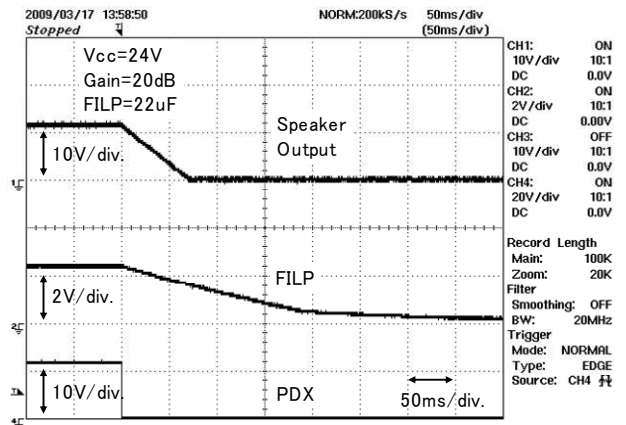

Fig.10 Waveform when activating Power-down

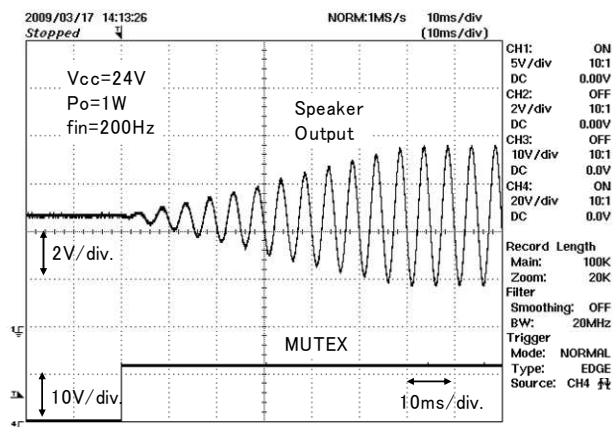

Fig.11 Waveform when releasing Soft-mute

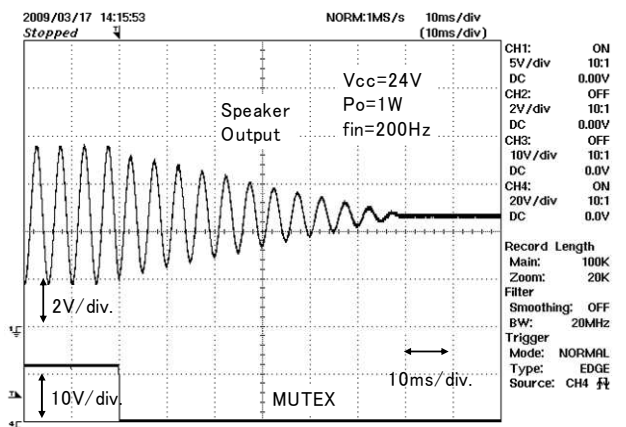

Fig.12 Waveform when activating Soft-mute

● Typical Characteristics Data (SE × 2ch) Measured on ROHM's evaluation board.

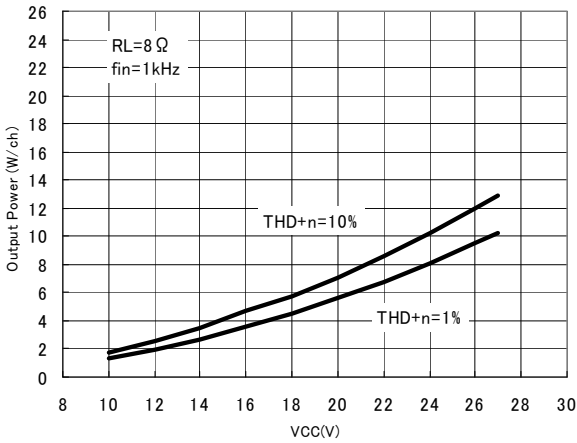

Fig.13 Power supply voltage—Output power (RL=8Ω)

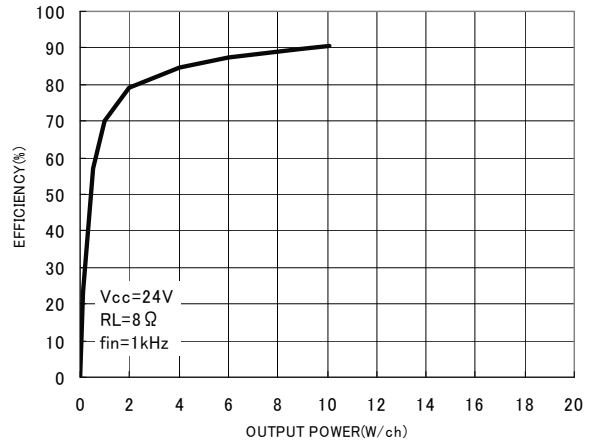

Fig.14 Output power—Efficiency (RL=8Ω)

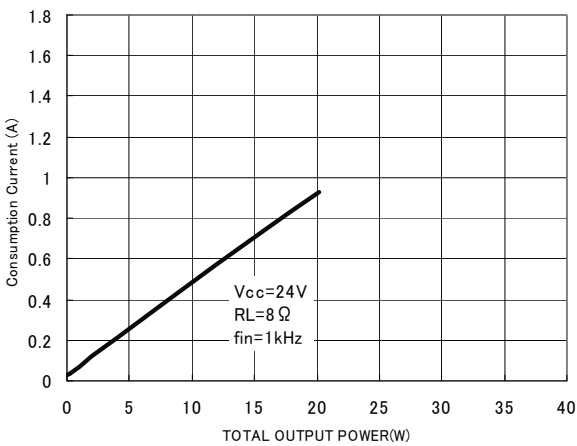

Fig.15 Total output power—Current consumption (RL=8Ω)

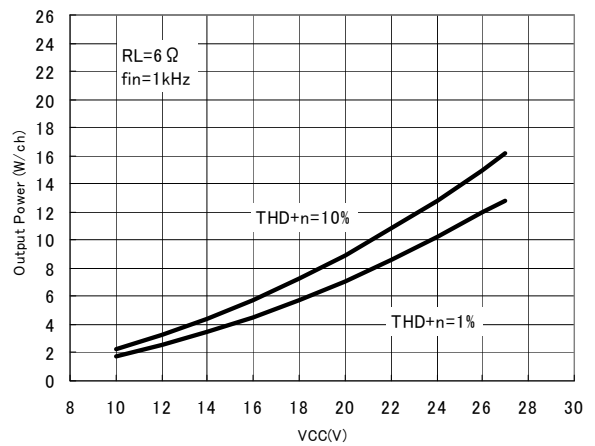

Fig.16 Power supply voltage—Output power (RL=6Ω)

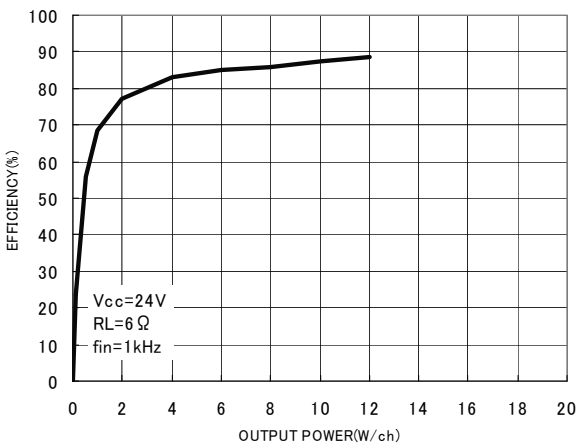

Fig.17 Output power—Efficiency (RL=6Ω)

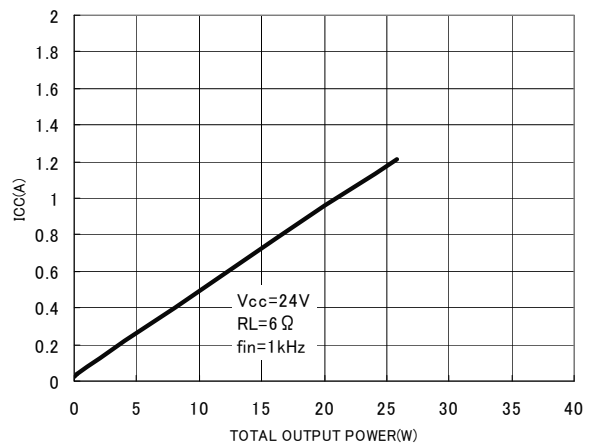

Fig.18 Total output power—Current consumption (RL=6Ω)

● Typical Characteristic Data (SE × 2ch) Measured on ROHM's evaluation board.

Dotted lines of the graphs indicate continuous output power by installing additional heat sinks.

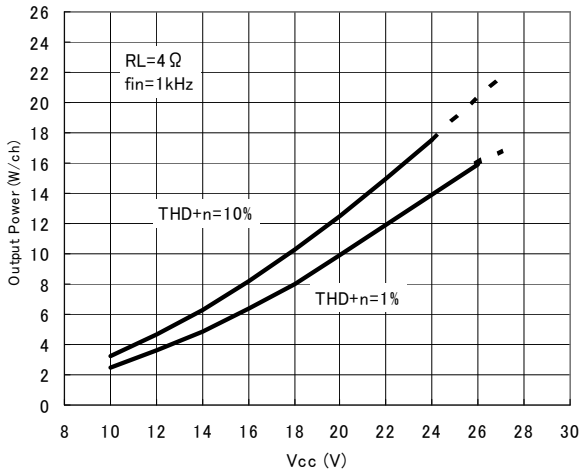

Fig.19 Power supply voltage—Output power ($R_L=4\ \Omega$)

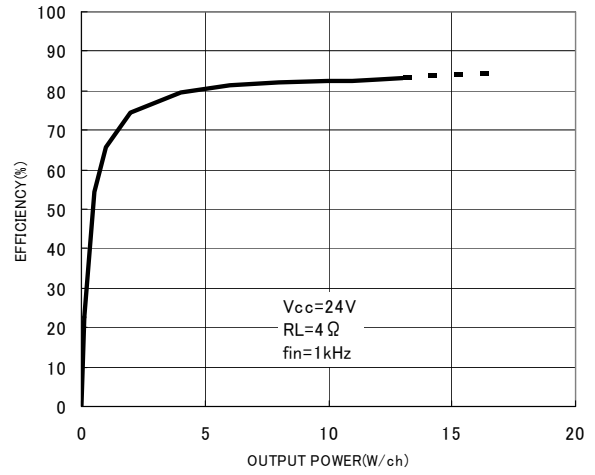

Fig.20 Output power—Efficiency ($R_L=4\ \Omega$)

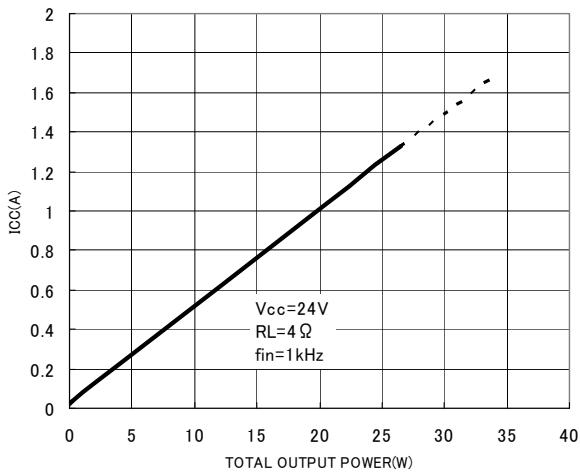

Fig.21 Total output power—Current consumption ($R_L=4\ \Omega$)

● Typical Characteristic Data (SE × 2ch) Measured on ROHM's evaluation board.

Dotted lines of the graphs indicate continuous output power by installing additional heat sinks.

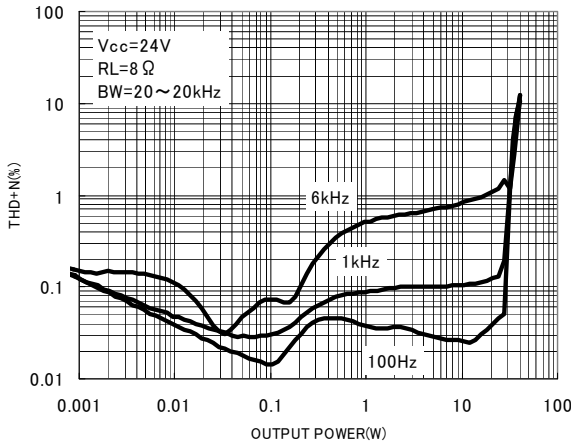

Fig.22 Output power—THD+n

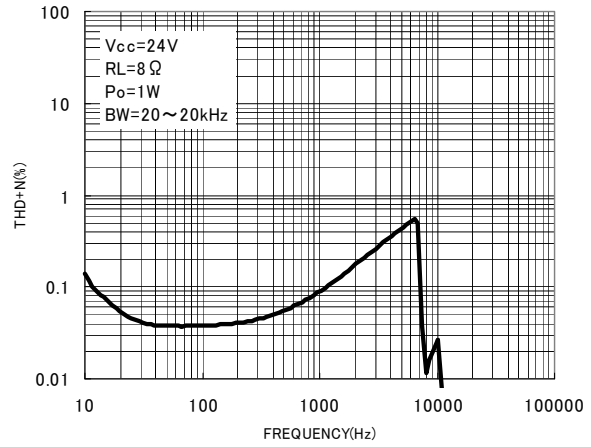

Fig.23 Frequency—THD+n

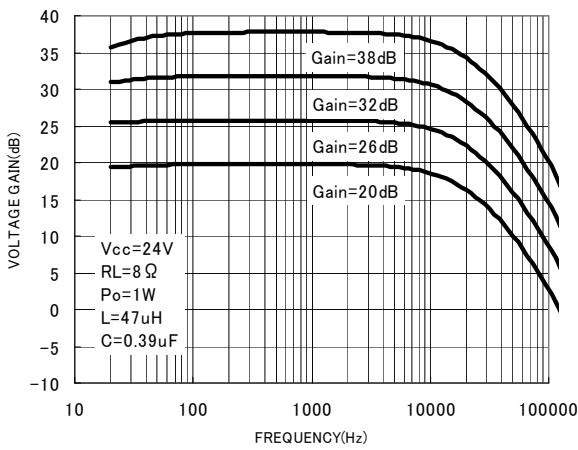

Fig.24 Frequency—Voltage gain

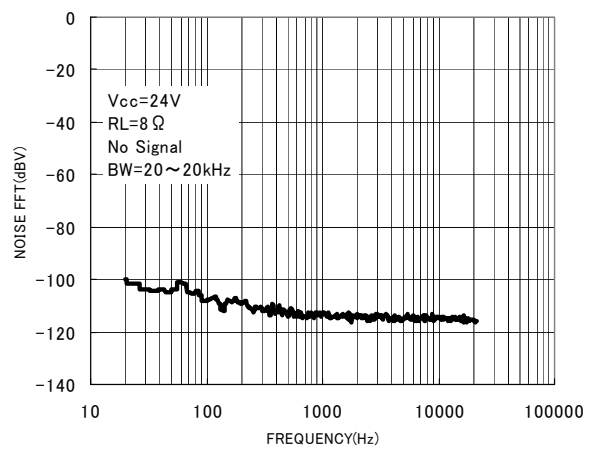

Fig.25 FFT of Output Noise Voltage

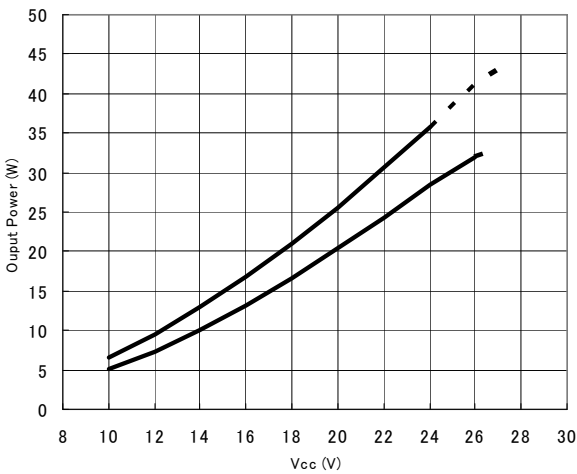

Fig.26 Power supply voltage—Output power ($R_L=8\Omega$)

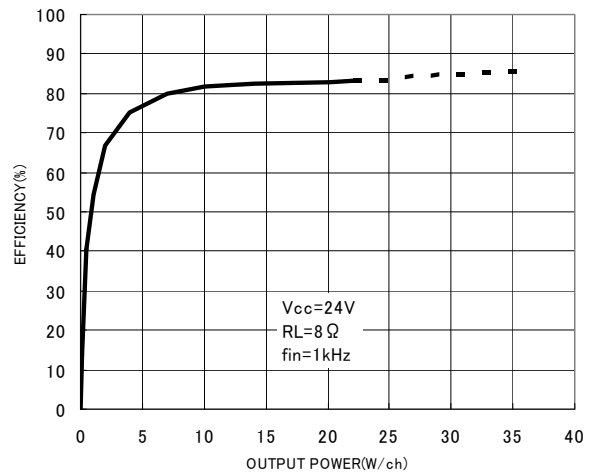

Fig.27 Output power—Efficiency ($R_L=8\Omega$)

● Typical Characteristics Data (BTL) Measured on ROHM's evaluation board.

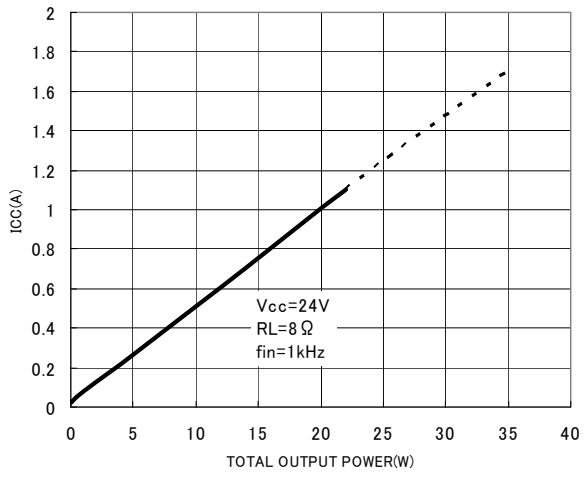
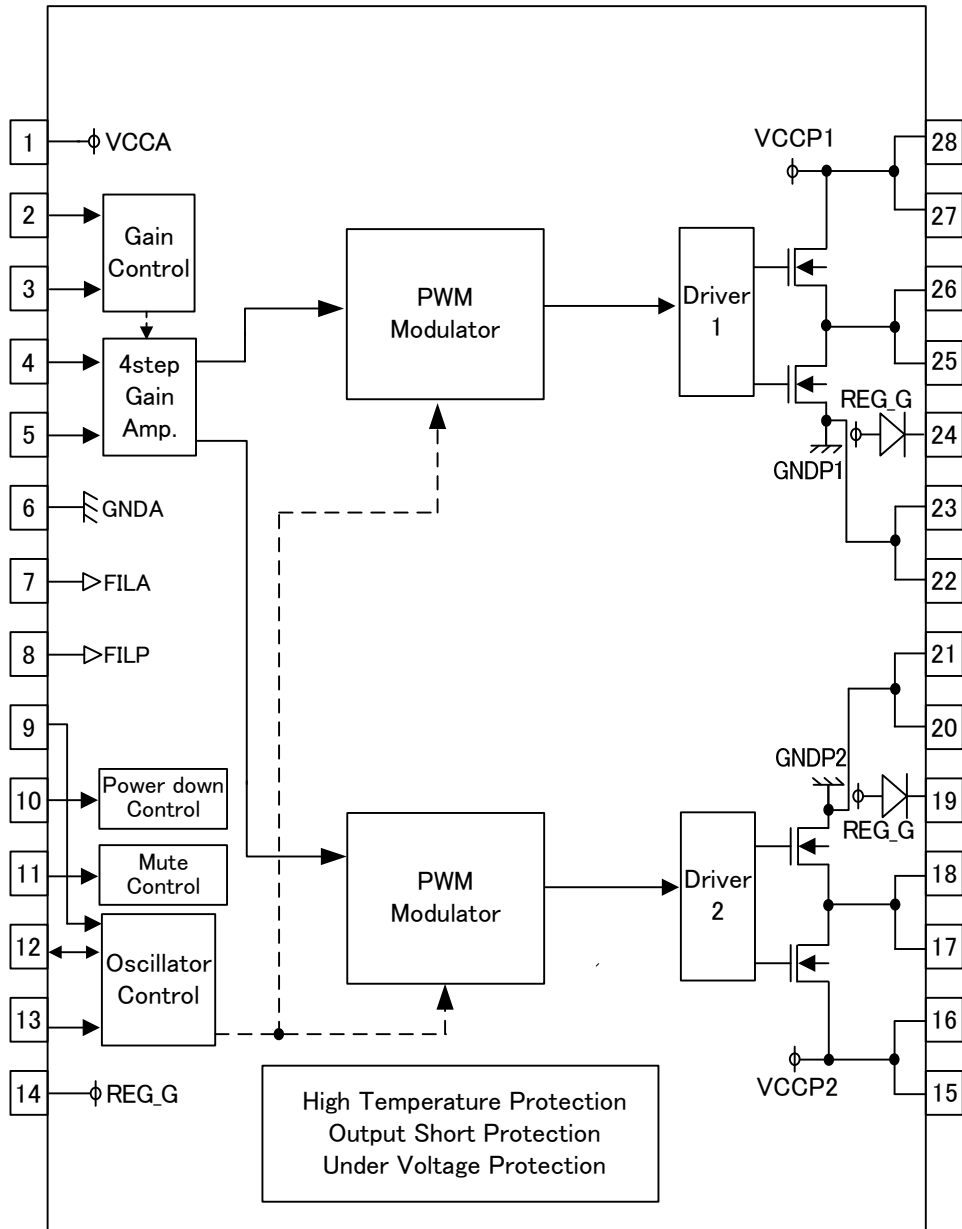

Fig.28 Total output power—Current consumption (R_L=8Ω)

● Pin configuration and Block diagram



● Pin function explanation (Provided pin voltages are typ. values)

Pin No.	Pin name	Pin voltage	Pin explanation	Internal equivalence circuit
1	VCCA	Vcc	Power supply pin for Analog signal	
2 3	GAIN0 GAIN1	—	Gain control pin	
4 5	IN1 IN2	2.5V	ch1 Analog signal input pin ch2 Analog signal input pin Input audio signal via a capacitor.	
6	GNDA	0V	Gnd pin for Analog signal	
7	FILA	2.5V	Bias pin for Analog signal Please connect the capacitor.	
8	FILP	2~4V	Bias pin for PWM signal Please connect the capacitor.	
9	ROSC	2.5V	Internal PWM sampling clock frequency setting pin Please connect the resistor setting Master mode. Please connect the capacitor setting Slave mode.	
10	PDX	—	Power down control pin H: Power down OFF L: Power down ON	

Pin No.	Pin name	Pin voltage	Pin explanation	Internal equivalence circuit
11	MUTEX	—	Speaker output mute control pin H: Mute OFF L: Mute ON	
12	OSC	—	PWM sampling clock input and output pin When using 2 or more ICs, connect to these pins.	
13	MS	—	Master mode and Slave mode control pin H: Slave mode L: Master mode	
14	REG_G	5.5V	Internal power supply pin for Gate driver Please connect the capacitor.	
15 16	VCCP2	Vcc	Power supply pin for ch2 PWM signal	
17 18	OUT2	0V~Vcc	Output pin of ch2 PWM Please connect to Output LPF.	
19	BSP2	5V	Boot-strap pin of ch2 Please connect the capacitor.	
20 21	GNDP2	0V	Gnd pin for ch2 PWM signal	

Pin No.	Pin name	Pin voltage	Pin explanation	Internal equivalence circuit
22 23	GNDP1	0V	Gnd pin for ch1 PWM signal	
24	BSP1	5V	Boot-strap pin of ch1 Please connect the capacitor.	
25 26	OUT1	0V~Vcc	Output pin of ch1 PWM Please connect to Output LPF.	
27 28	VCCP1	Vcc	Power supply pin for ch1 PWM signal	

●Audio input circuit (pin4 and pin5)

Connect the audio input pin with a prior-stage circuit via coupling capacitors C4 and C5. Because C4, C5 and input impedance R4, R5 of the IC circuit compose the primary HPF, the values determine an input low-band cutoff frequency. Input cutoff frequencies are calculated by the following formulas:

$$f_C = \frac{1}{2\pi R4 \cdot C4} [\text{Hz}] \quad f_C = \frac{1}{2\pi R5 \cdot C5} [\text{Hz}]$$

An excessively high capacitance of an input coupling capacitor results in a longer period required for stabilizing a power input pin voltage after turning on the power supply. Note that placing the MUTEX pin (pin11) at "L" level (mute turned off) for avoidance of Pop-noise before stabilizing an input pin. R4 and R5 are changed by Gain setting.

GAIN1 (3pin)	GAIN0 (2pin)	R4,R5 input impedance(TYP.)	Amplifier Gain (SE)	Amplifier Gain (BTL)
L	L	40kΩ	14dB	20dB
L	H	40kΩ	20dB	26dB
H	L	26.7kΩ	26dB	32dB
H	H	16kΩ	32dB	38dB

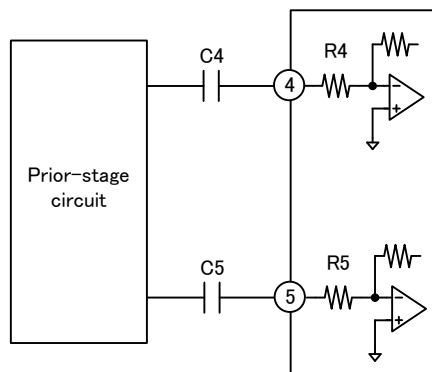

Fig. 29 Coupling capacitors of audio input pins

●Output LC Filter Circuit (Pins 17, 18, 25, and 26)

An output filter is required to eliminate radio-frequency components exceeding the audio-frequency region supplied to a load (speaker). Because this IC uses sampling clock between 480kHz and 720kHz in the output PWM signals, the high-frequency components must be appropriately removed.

This section takes an example of an LC type LPF, in which coil L_{fil} and capacitor C_{fil} compose a differential filter with an attenuation property of -12dB/oct. A large part of switching currents flow to capacitor C_{fil} , and only a small part of the currents flow to speaker R_L . The following is a table for output LC filter constants.

Speaker	R_L	$L_{fil}[\mu H]$	$C_{fil1}[\mu F]$	$C_{fil2}[\mu F]$
SE output	4 Ω	22	0.68	—
	6 Ω	33	0.47	—
	8 Ω	47	0.39	—
BTL output	4 Ω	15	0.22	1
	6 Ω	22	0.15	0.68
	8 Ω	33	0.1	0.47

In SE(single end) applications, the dc blocking capacitor (C_{se}) and speaker impedance compose the primary HPF. The cutoff frequency is determined by

$$f_C = \frac{1}{2\pi C_{SE} \cdot R_L} [Hz]$$

The following table is C_{se} setting at cutoff frequency 20Hz, 40Hz, and 60Hz.

R_L	$C_{SE}[\mu F]$		
	$f_c=60Hz$	$f_c=40Hz$	$f_c=20Hz$
4 Ω	680	1000	2200
6 Ω	470	680	1500
8 Ω	330	470	1000

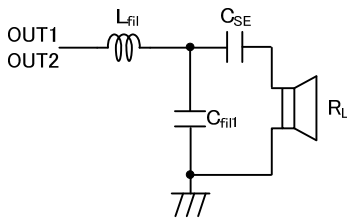

Fig.30 SE filter configuration

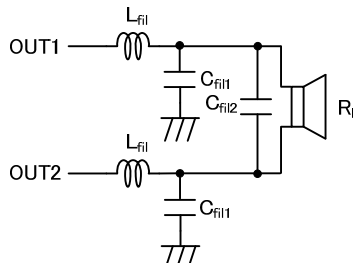

Fig.31 BTL filter configuration

●Control pins function

①GAIN0, GAIN1 function

GAIN1 (Pin 3)	GAIN0 (Pin 2)	Amplifier Gain (SE)	Amplifier Gain (BTL)
L	L	14dB	20dB
L	H	20dB	26dB
H	L	26dB	32dB
H	H	32dB	38dB

②MUTEX, PDX function

MUTEX (Pin 11)	PDX (Pin 10)	Speaker output	Power down
L	L	HiZ_Low	ON
L	H	Mute	OFF
H	H	Normal operation	OFF
H	L	Forbidden	

③MS function

MS (13pin)	Mode
L	Master mode
H	Slave mode

※Please connect ROSC terminal (pin 9) to 22kohm resistor for setting master mode.

※Please connect to the following filter, and input clock (duty = 50%) to OSC terminal (pin 12) for setting slave mode.

PWM Sampling frequency is sited from input clock. If input clock have noise (ex.Jitter), noise appear to Speaker output.

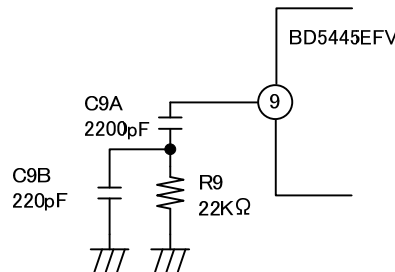

Fig.32 ROSC terminal filter circuit for setting slave mode.

※High level input voltage (Max.voltage) of tease control pin is equal to Vcc voltage. But absolute max.voltage of In0(pin4),ROSC(pin9),OSC(pin12) and REG_G(pin14) is 5.3V. Tease pins may break, when short next pins. If these pins short to Vcc, connecting through 10kΩ resistor prevent IC from destruction.

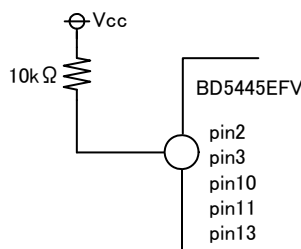
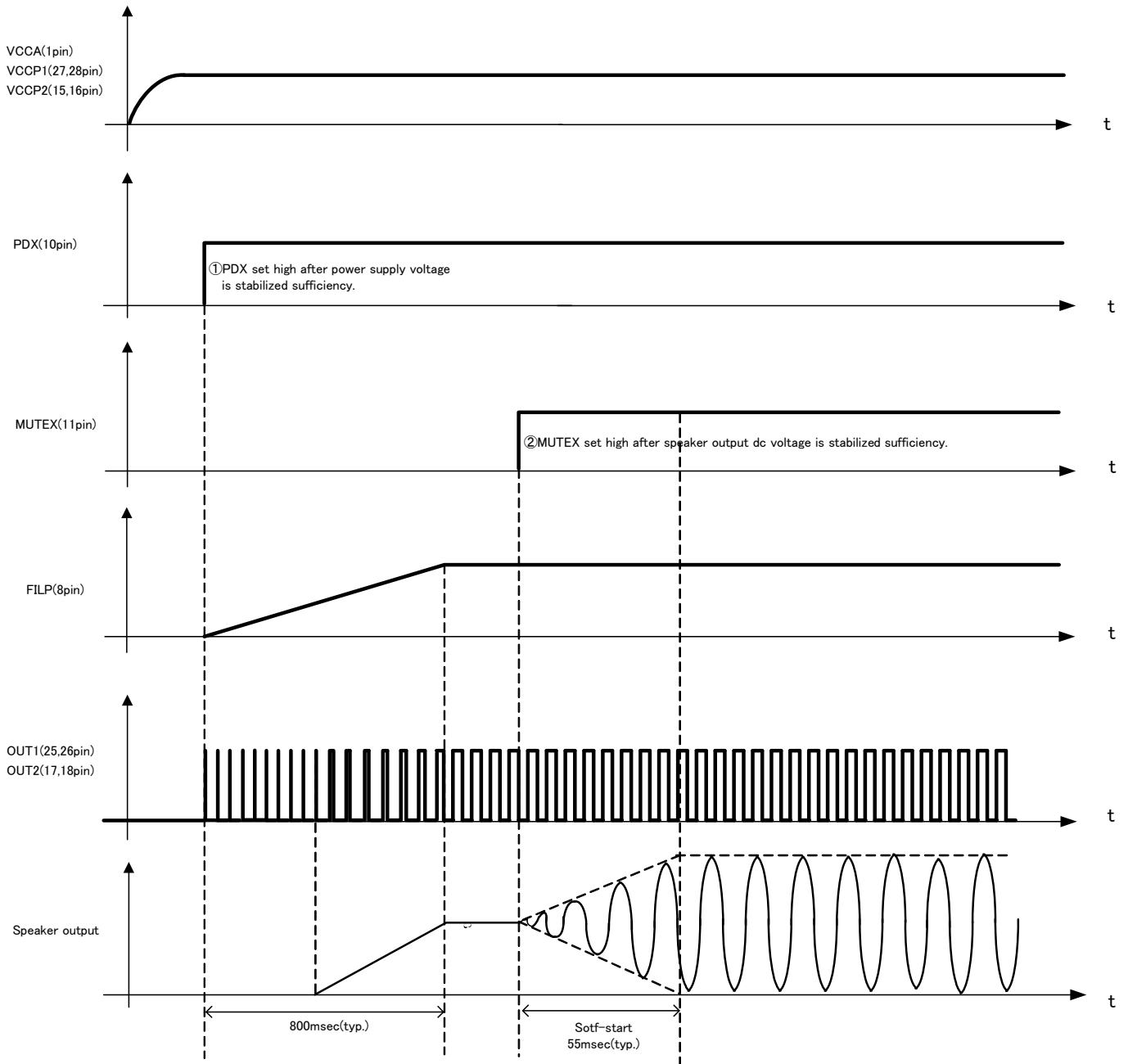
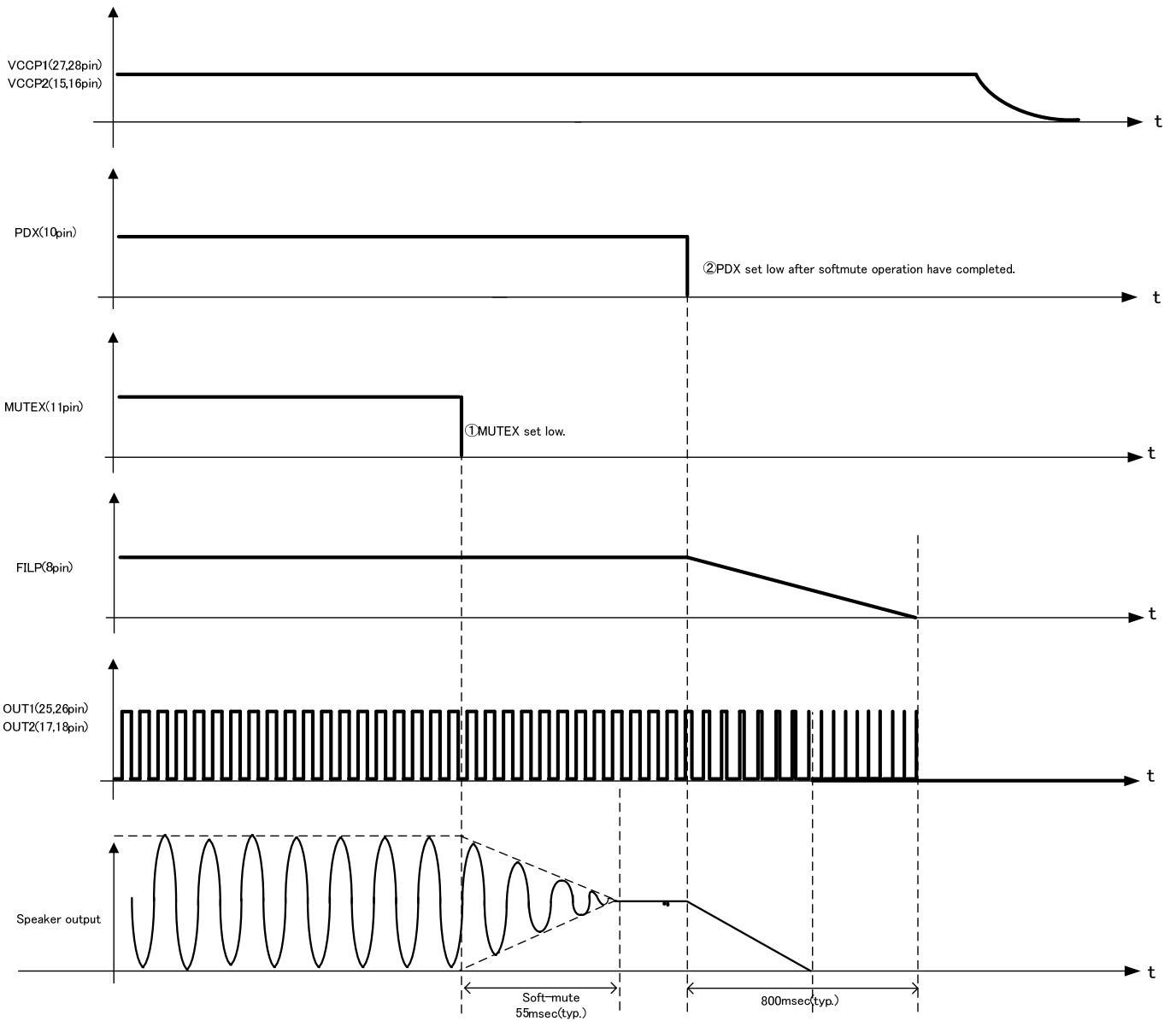

Fig.33

● Power supply start-up sequence



● Power supply shut-down sequence



Power supply shut down, after PDX (Pin 10) change H→L. The IC has possibly to sound POP noise, if PDX (Pim10) keep H. Speaker's coupling capacitor (Fig30:Cse) don't discharge at this time. Pop-noise may sound when power supply start up at the next time.

● Power supply start-up and shut-down sequence for single control

Short between PDX(Pin 10) and MUTEX(Pin 11), enable to control these pins at one time.

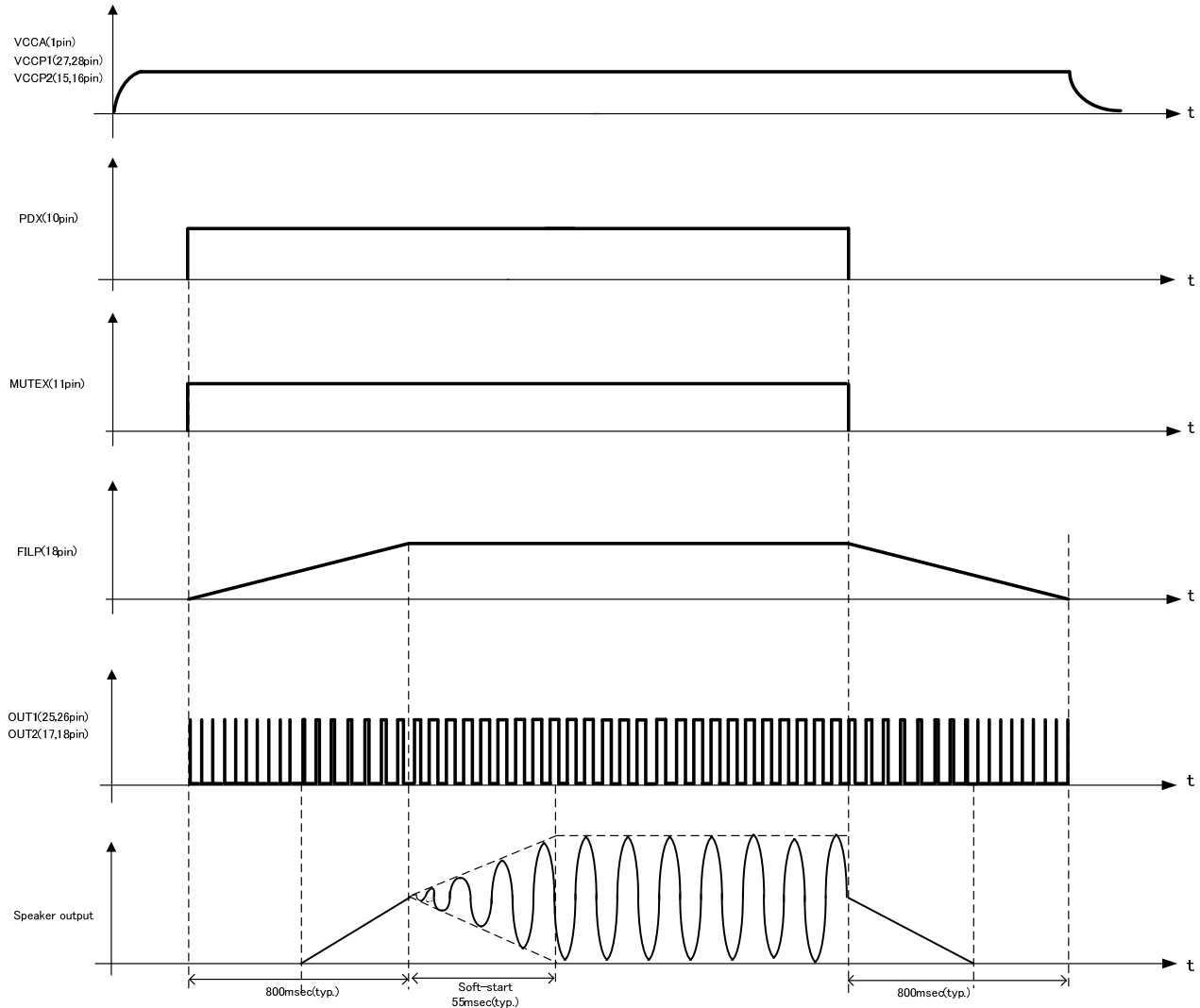

PDX (Pin 10) and MUTEX (Pin 11) set low at one time, while this IC is on normal mode, the IC don't operate soft-mute. If low frequency and high level signal input this time, the IC has possibility to sound POP-Noise. To avoid this POP-Noise configure the following circuit, because PDX (Pin10) enables to change low after MUTEX (Pin11) have changed. This sequence make less POP-Noise because the IC can operate soft-mute.

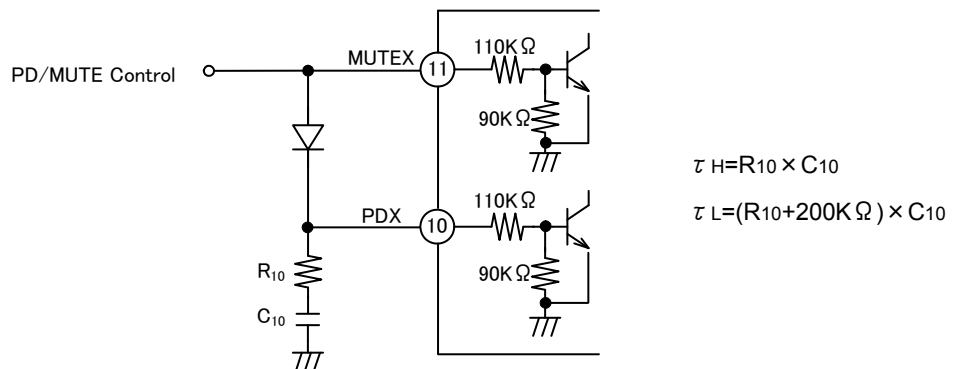

Control configuration for soft-mute operation by single control

●About the protection function

Protection function	Detecting & Releasing condition		PWM Output
Output short protection	Detecting condition	Detecting current = 10A (TYP.)	HiZ_Low
	Releasing condition	Release from Vcc or Gnd short	Normal operation
High temperature protection	Detecting condition	Chip temperature to be above 150°C (TYP.)	HiZ_Low
	Releasing condition	Chip temperature to be below 125°C (TYP.)	Normal operation
Under voltage protection	Detecting condition	Power supply voltage to be below 8V (TYP.)	HiZ_Low
	Releasing condition	Power supply voltage to be above 9V (TYP.)	Normal operation

※ All protection functions are restored automatically when the fault is removed.

1) Output short protection (Short to the power supply)

This IC has the output short protection circuit that stops the PWM output when the PWM output is short-circuited to the power supply due to abnormality.

Detecting condition – It will detect when PDX pin is set High and the current that flows in the PWM output pin becomes 10A(TYP.) or more. The PWM output instantaneously enters the state of HiZ-Low if detected, and IC does the latch.

Releasing method – This IC detect releasing from Vcc short every 220msec(TYP.). Normal operation is restored when releasing from Vcc short.

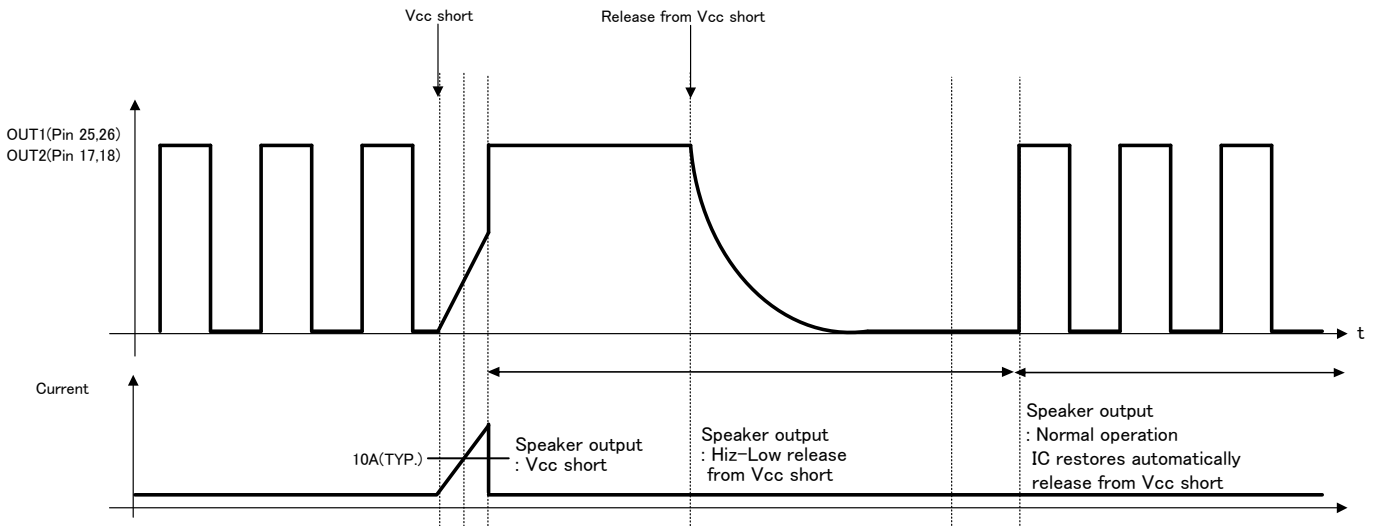

2) Output short protection (Short to Gnd)

This IC has the output short protection circuit that stops the PWM output when the PWM output is short-circuited to Gnd due to abnormality.

Detecting condition – It will detect when PDX pin is set High and the current that flows in the PWM output terminal becomes 10A(TYP.) or more. The PWM output instantaneously enters the state of HiZ-Low if detected, and IC does the latch.

Releasing method – This IC detect releasing from Gnd short every 220msec(TYP.). Normal operation is restored when releasing from Gnd short.

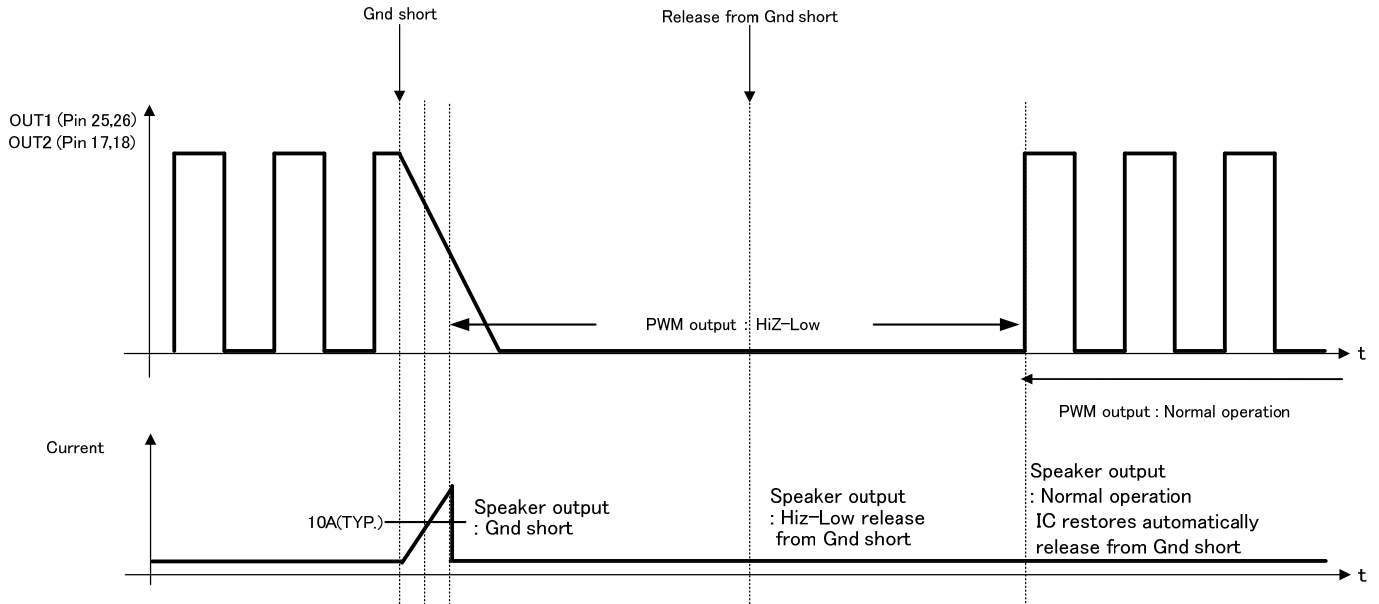

(※)Remark of output short protection

Circuit current changes suddenly, when IC detects output short protection. At this time IC may break, because supply voltage rise up by back electromotive force. Decoupling capacitors (VCCP1 and VCCP2) should be placed as close to the IC as possible. (recommend $4.7\ \mu\text{F}$ or more.)

3) High temperature protection

This IC has the high temperature protection circuit that prevents thermal reckless driving under an abnormal state for the temperature of the chip to exceed $T_{jmax}=150^{\circ}\text{C}$.

Detecting condition - It will detect when PDX pin is set High and the temperature of the chip becomes 150°C (TYP.) or more.
The speaker output is muted through a soft-mute when detected.

Releasing condition - It will release when PDX pin is set High and the temperature of the chip becomes 120°C (TYP.) or less.
The speaker output is outputted through a soft-start when released.

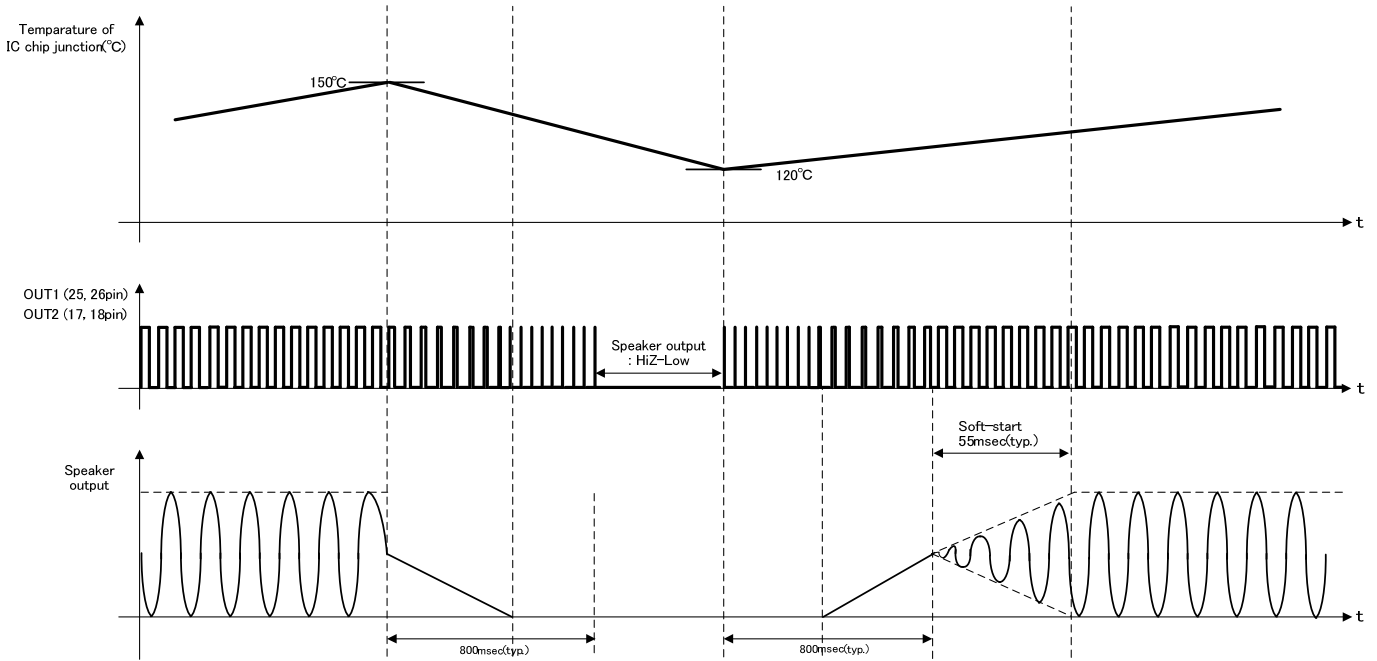

4) Under voltage protection

This IC has the under voltage protection circuit that make speaker output mute once detecting extreme drop of the power supply voltage.

Detecting condition – It will detect when PDX pin is set High and the power supply voltage becomes lower than 8V.

The speaker output is muted when detected.

Releasing condition – It will release when PDX pin is set High and the power supply voltage becomes more than 9V.

The speaker output is outputted through a soft-start when released.

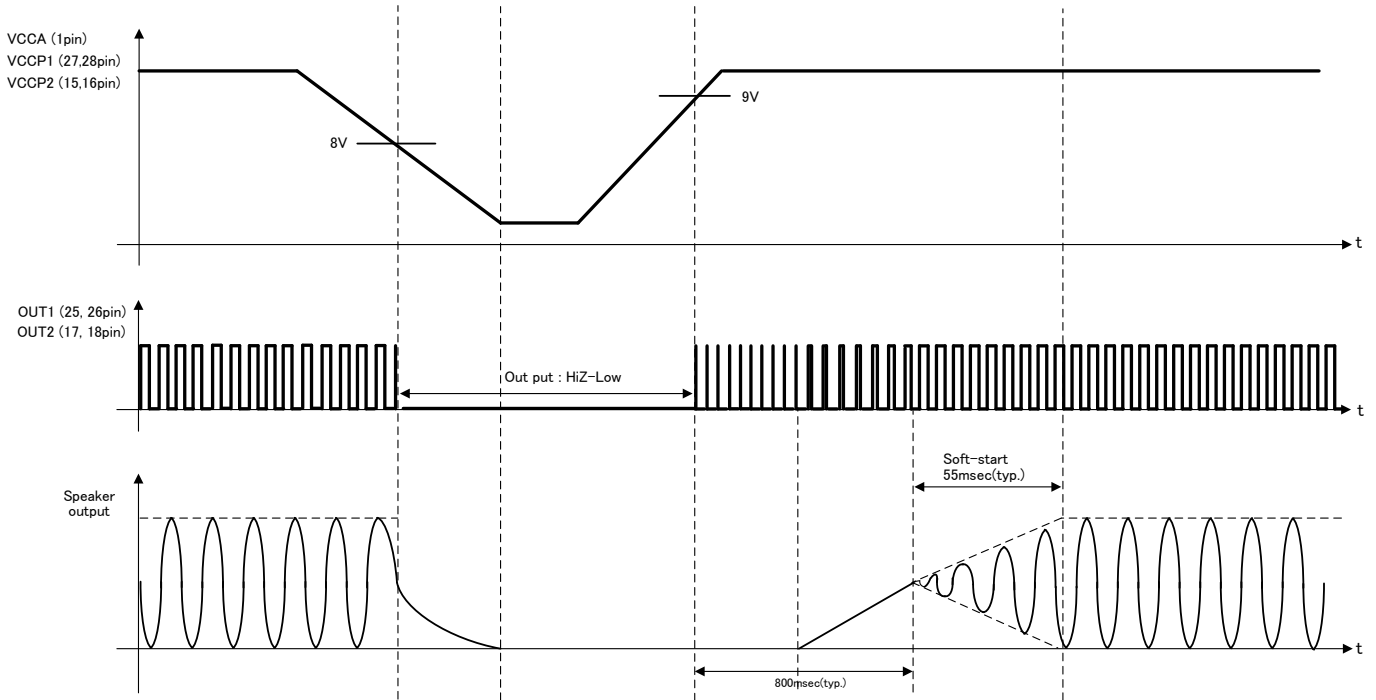

● Application Circuit Example (single-ended output × 2)

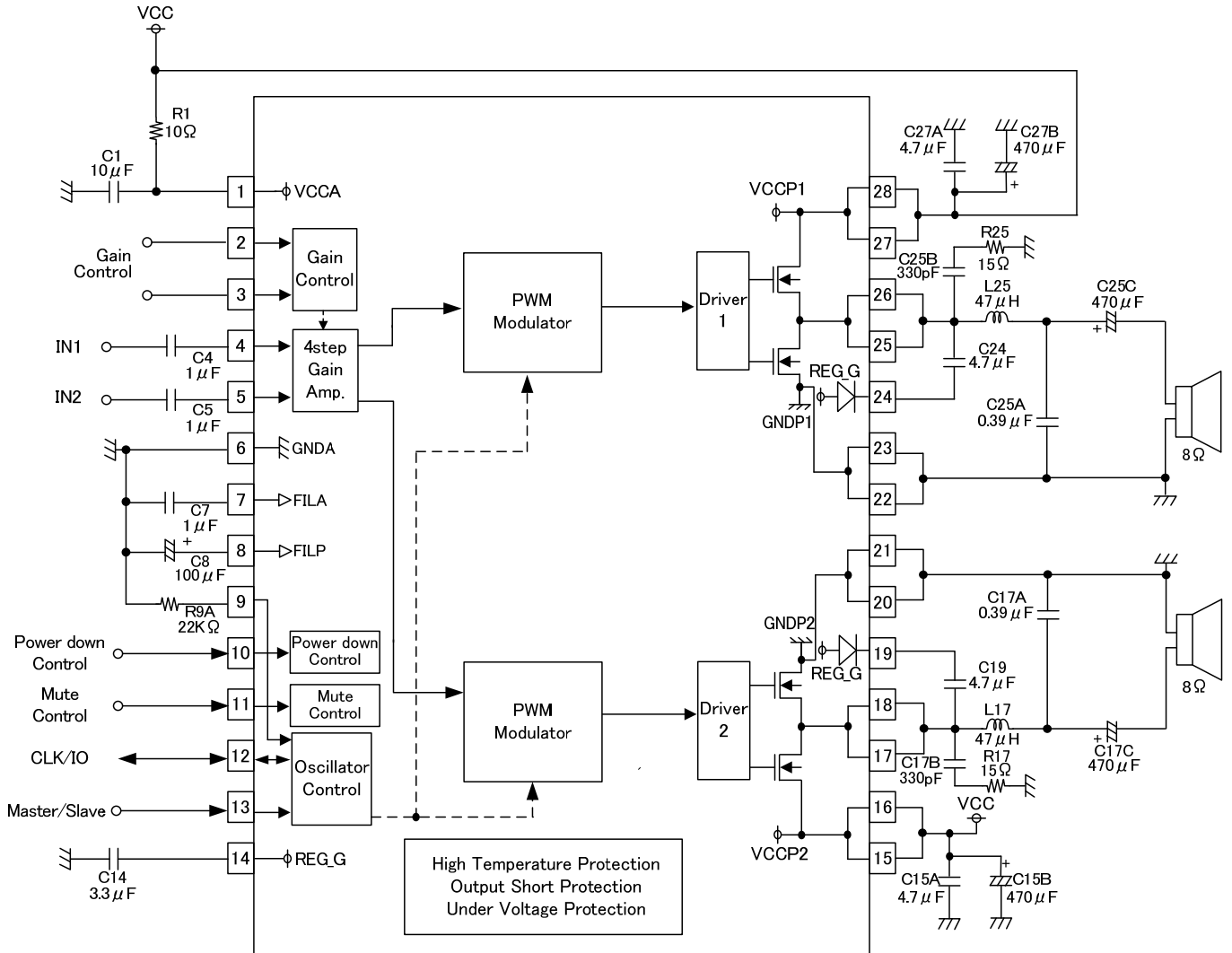

●BOM List (single-ended output × 2)

Parts	Parts No.	Value	Company	Product No.	Rated Voltage	Tolerance	Size
IC	U1	—	ROHM	BD5444EFV	—	—	9.7mm×6.4mm
Inductor	L17, L25	47μH	TOKO	A7503AY-470M	—	±20%	φ11mm×13.5mm
Resistor	R1	10Ω	ROHM	MCR18EZHFL10R0	1/4W	F(±1%)	3.2mm×1.6mm
	R9A	22kΩ		MCR01MZPF2202	1/16W	F(±1%)	1.0mm×0.5mm
	R17,R25	15Ω		MCR18EZHFL15R0	1/4W	F(±1%)	3.2mm×1.6mm
Capacitor	C1	10μF	MURATA	GRM32DF51H106ZA01	50V	Y5V (+80% / -20%)	3.2mm×2.5mm
	C19, C24	4.7uF		GRM21BB31C475KA87	16V	B(±10%)	2.0mm×1.2mm
	C15A, C27A	4.7uF		GRM31CF11H475ZA01	50V	F (+80% / -20%)	3.2mm×1.6mm
	C17A, C25A	0.39uF		GRM32MB11H394KA01	50V	B(±10%)	3.2mm×2.5mm
	C14	3.3μF		GRM188B31A335KE15	10V	B(±10%)	1.6mm×0.8mm
	C4, C5, C7	1μF		GRM185B30J105KE25	6.3V	B(±10%)	1.6mm×0.8mm
	C17B, C25B	330pF		GRM188B11H331KA01	50V	B(±10%)	1.6mm×0.8mm
Electrolytic Capacitor	C15B, C17C, C25C, C27B	470μF	Rubycon	35ZLH470M	35V	±20%	φ10mm×16mm
	C8	100uF		16ZLH100M	16V	±20%	φ5mm×11mm

(*1) Please change the following parts, when using RL=6Ω speaker.

Inductor	L17, L25	33μH	TOKO	A7503AY-330M	—	±20%	φ11mm×13.5mm
Resistor	R17,R25	10Ω	ROHM	MCR18EZHFL10R0	1/4W	F(±1%)	3.2mm×1.6mm
Capacitor	C17A, C25A	0.47μF	MURATA	GRM32MB11H474KA01	50V	B(±10%)	3.2mm×2.5mm
	C17B, C25B	680pF		GRM188B11H681KA01	50V	B(±10%)	1.6mm×0.8mm
	C17C, C25C	680μF	Rubycon	35ZLH680M	35V	±20%	φ10mm×23mm

(*2) Please change the following parts, when using RL=4Ω speaker.

Inductor	L17, L25	22μH	TOKO	A7503AY-220M	-	±20%	φ11mm×13.5mm
Resistor	R17,R25	5.6Ω	ROHM	MCR18EZHFL5R60	1/4W	F(±1%)	3.2mm×1.6mm
Capacitor	C17A, C25A	0.68μF	MURATA	GRM32NB11H684KA01	50V	B(±10%)	3.2mm×2.5mm
	C17B, C25B	1000pF		GRM188B11H102KA01	50V	B(±10%)	1.6mm×0.8mm
	C17C, C25C	1000μF	Rubycon	35ZLH1000M	35V	±20%	φ12.5mm×20mm

● Application Circuit Example (BTL output)

