



Chipsmall Limited consists of a professional team with an average of over 10 year of expertise in the distribution of electronic components. Based in Hongkong, we have already established firm and mutual-benefit business relationships with customers from,Europe,America and south Asia,supplying obsolete and hard-to-find components to meet their specific needs.

With the principle of “Quality Parts,Customers Priority,Honest Operation,and Considerate Service”,our business mainly focus on the distribution of electronic components. Line cards we deal with include Microchip,ALPS,ROHM,Xilinx,Pulse,ON,Everlight and Freescale. Main products comprise IC,Modules,Potentiometer,IC Socket,Relay,Connector.Our parts cover such applications as commercial,industrial, and automotives areas.

We are looking forward to setting up business relationship with you and hope to provide you with the best service and solution. Let us make a better world for our industry!



Contact us

Tel: +86-755-8981 8866 Fax: +86-755-8427 6832

Email & Skype: info@chipsmall.com Web: www.chipsmall.com

Address: A1208, Overseas Decoration Building, #122 Zhenhua RD., Futian, Shenzhen, China



●Block Diagram

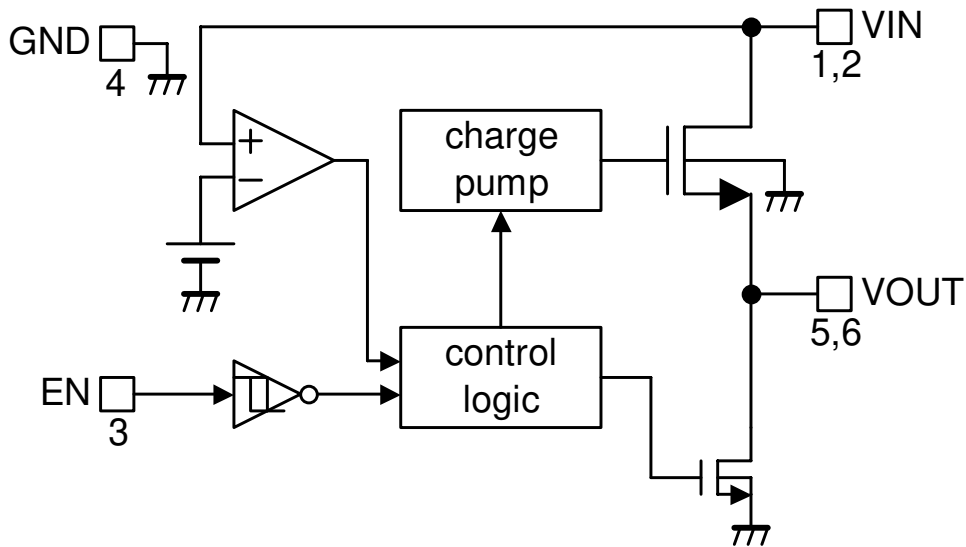

●Pin Configuration

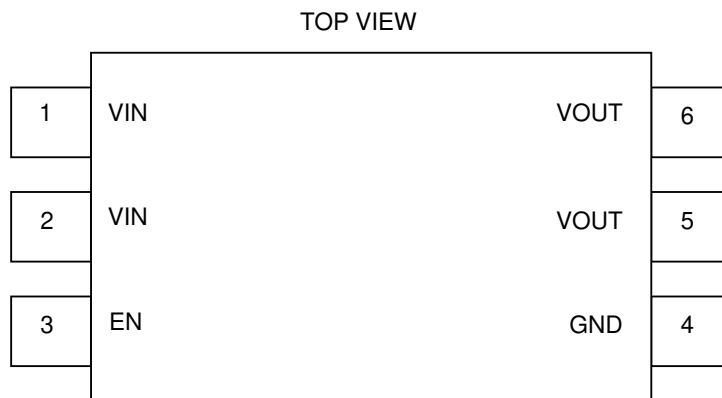

●Pin Description

Pin No.	Symbol	Pin Function
1	VIN	Switch input pin. At use, connect each pin outside.
2		
3	EN	Switch control input pin (hysteresis input) Switch ON at High.
4	GND	Ground
5	VOUT	Switch output pin At use, connect each pin outside.
6		

● Absolute Maximum Ratings

Parameter	Symbol	Ratings	Unit
Supply Voltage	V _{IN}	-0.3 to 6.0	V
Control input voltage	V _{EN}	-0.3 to V _{IN} + 0.3	V
Switch output voltage	V _{OUT}	-0.3 to 6.0	V
Storage temperature	T _{STG}	-55 to 150	°C
Power dissipation	P _d	510 ^{*1}	mW

*1 Derating : 4.08mW/°C for operation above Ta = 25°C.

● Recommended Operating Ratings

Parameter	Symbol	Ratings	Unit
Supply voltage	V _{IN}	3.0 to 5.5	V
Operating Temperature	T _{OPR}	-25 to 75	°C
Switch current	I _{OUT}	500	mA

● Electrical Characteristics Unless otherwise specified, Ta = 25°C, V_{IN} = 5V,

Parameter	Symbol	Limits			Unit	Condition
		Min.	Typ.	Max.		
Operating current	I _{DD}	-	50	75	μA	V _{EN} = 5V, V _{OUT} = Open
Standby current	I _{STB}	-	0.1	1	μA	V _{EN} = 0V, V _{OUT} = Open
EN input voltage	V _{ENH}	-	-	2.5	V	High level input voltage
	V _{ENL}	0.7	-	-	V	Low level input voltage
EN input leak current	I _{EN}	-1	0.01	1	μA	
Switch on resistance	R _{ON}	-	200	255	mΩ	V _{IN} = 5V
		-	250	335	mΩ	V _{IN} = 3.3V
Switch leak current	I _{LEAK}	-	-	10	μA	At switch OFF
Switch rise time	T _{ON1}	-	0.4	0.8	ms	RL=10Ω. Refer to the timing diagram in Figure 2.
Switch rise delay time	T _{ON2}	-	0.5	1.0	ms	RL=10Ω. Refer to the timing diagram in Figure 2.
Switch fall time	T _{OFF1}	-	1	2	us	RL=10Ω. Refer to the timing diagram in Figure 2.
Switch fall delay time	T _{OFF2}	-	2	4	us	RL=10Ω. Refer to the timing diagram in Figure 2.
UVLO threshold voltage	V _{UVLO}	1.9	2.2	2.5	V	V _{IN} increasing
		1.8	2.1	2.4	V	V _{IN} decreasing
Discharge resistance	R _{DISC}	-	200	350	Ω	V _{EN} = 0V, I _L = 1mA
Discharge current	I _{DISC}	0.8	1.8	-	mA	V _{EN} = 0V, V _{IN} = V _{OUT} = 1.8V

● Measurement Circuit

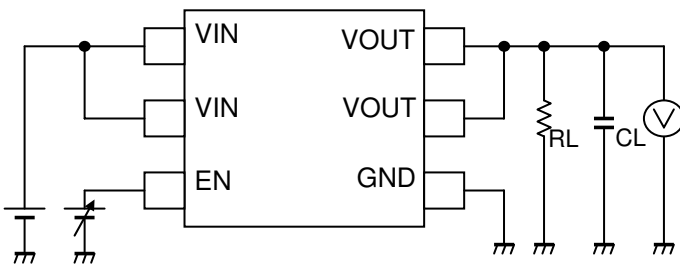

Figure 1. Measurement circuit

● Timing Diagram

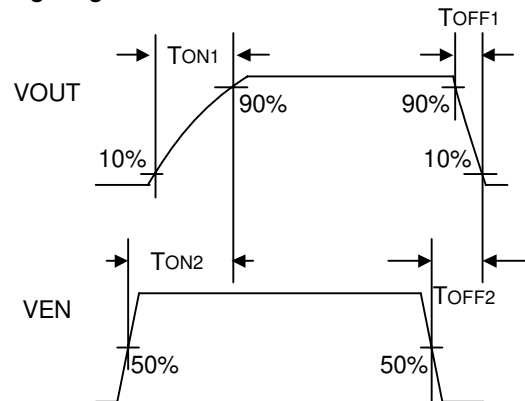

Figure 2. Timing diagram

● Typical Performance Curves

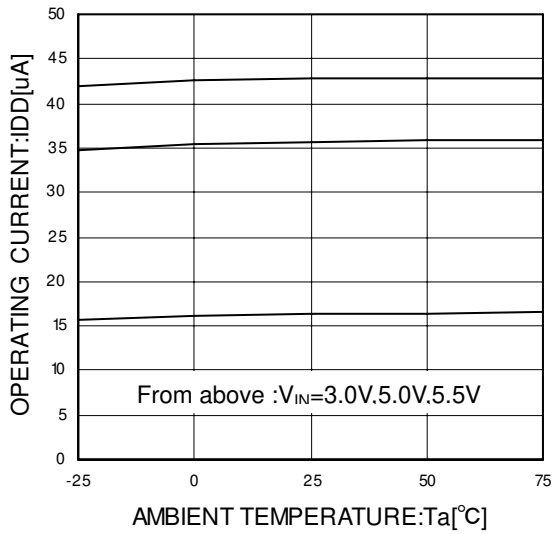

Figure 3. Operating current

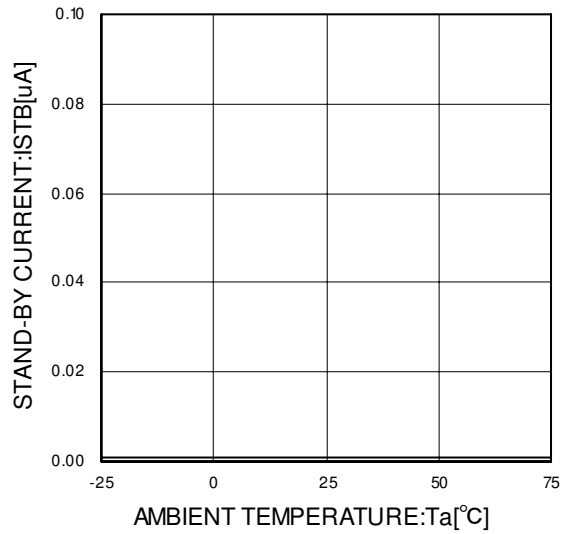

Figure 4. Standby current

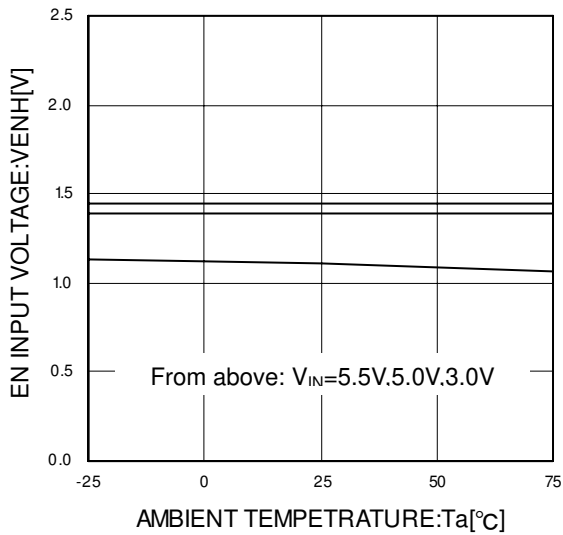

Figure 5. EN threshold voltage (High level input voltage)

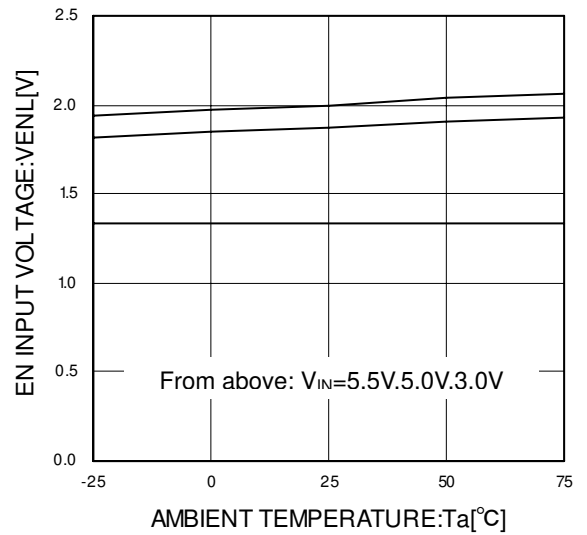

Figure 6. EN threshold voltage (Low level input voltage)

● Typical Performance Curves - continued

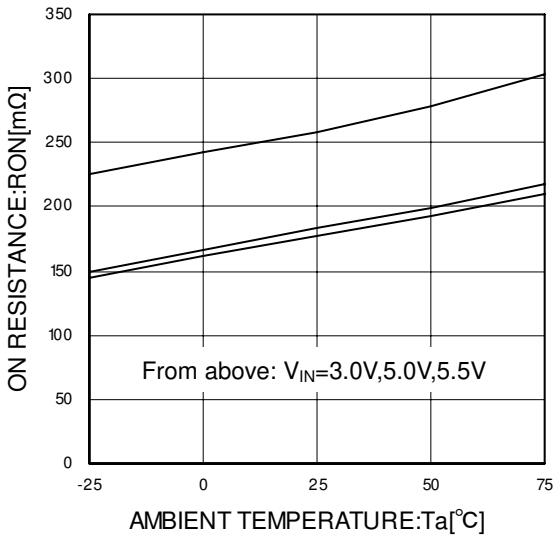

Figure 7. Switch on resistance

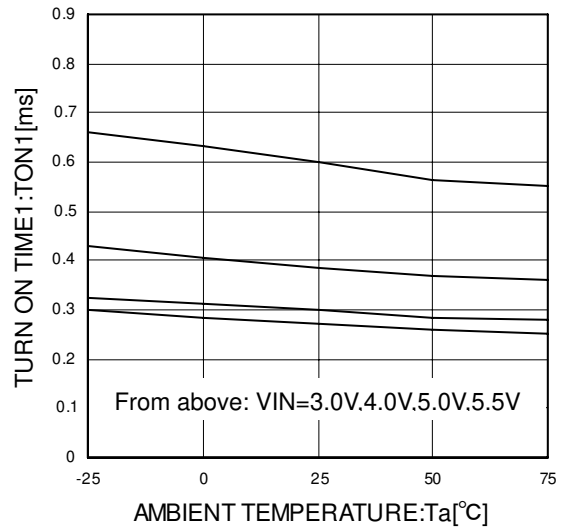

Figure 8. Switch rise time

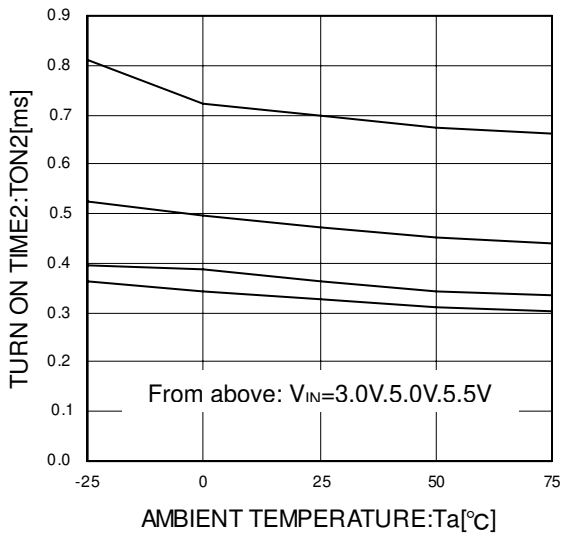

Figure 9. Switch rise delay time

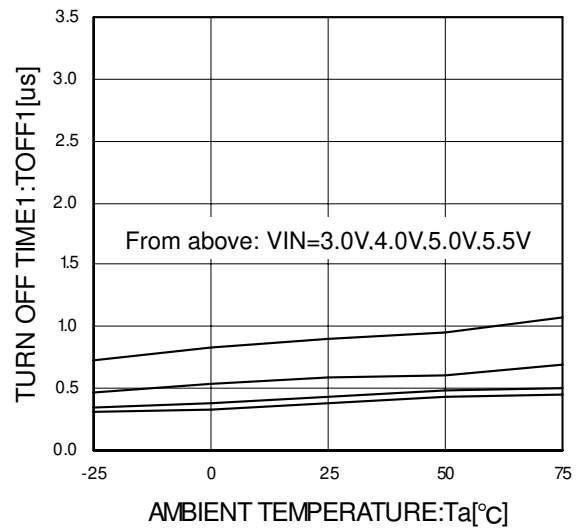

Figure 10. Switch fall time

● Typical Performance Curves - continued

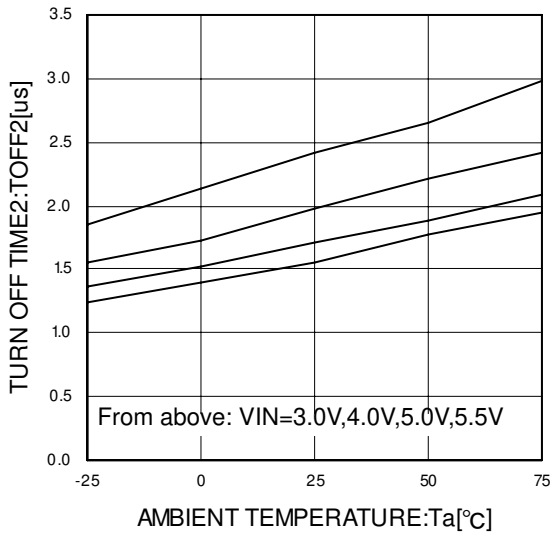

Figure 11. Switch fall delay time

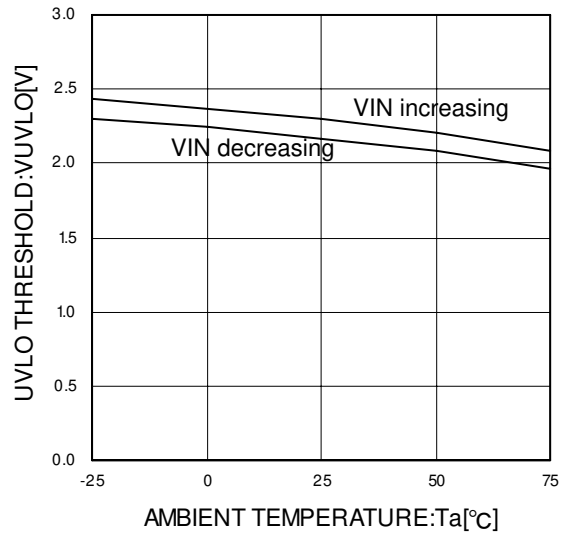

Figure 12. UVLO threshold voltage

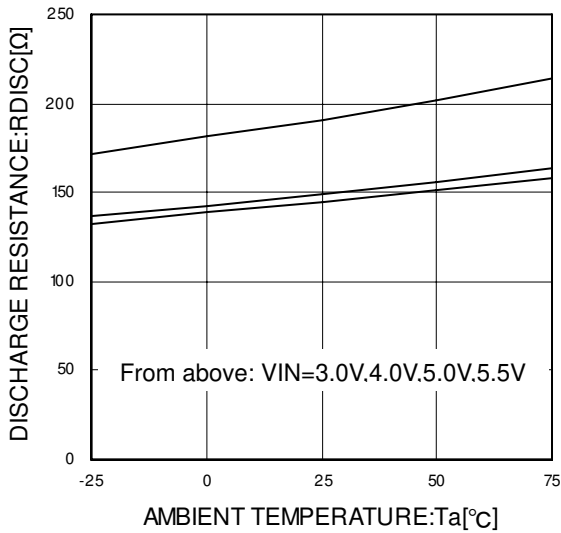

Figure 13. Discharge resistance

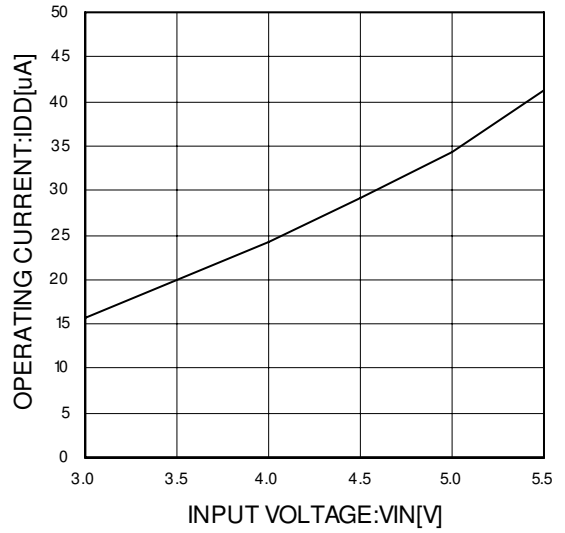

Figure 14. Operating current

● Typical Performance Curves - continued

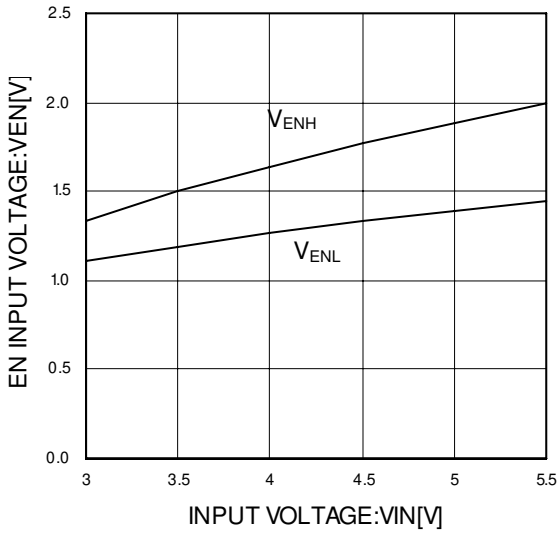

Figure 15. EN threshold voltage

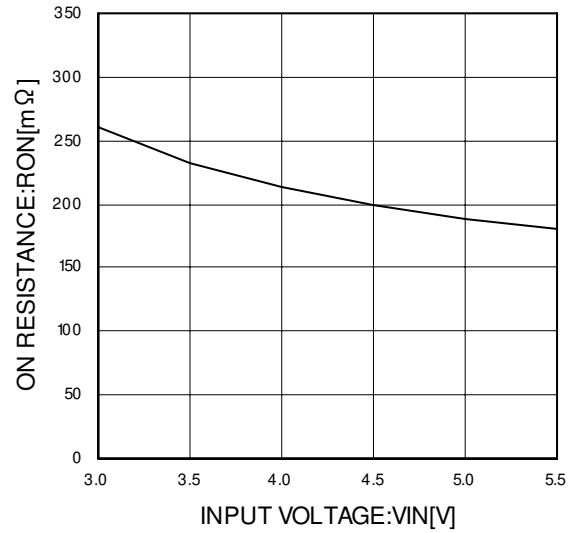

Figure 16. Switch on resistance

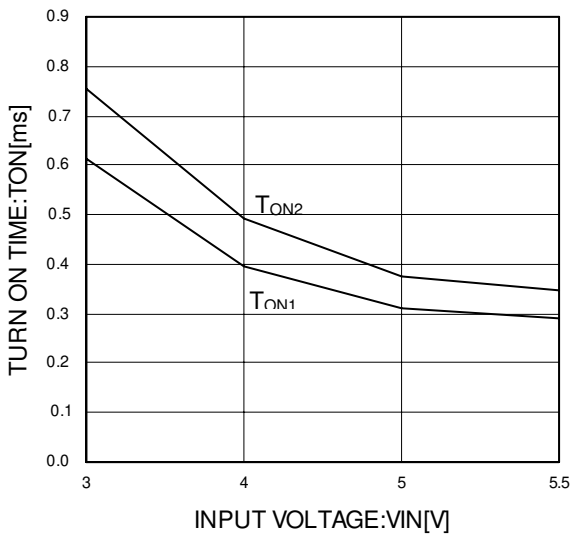

Figure 17. Switch rise time

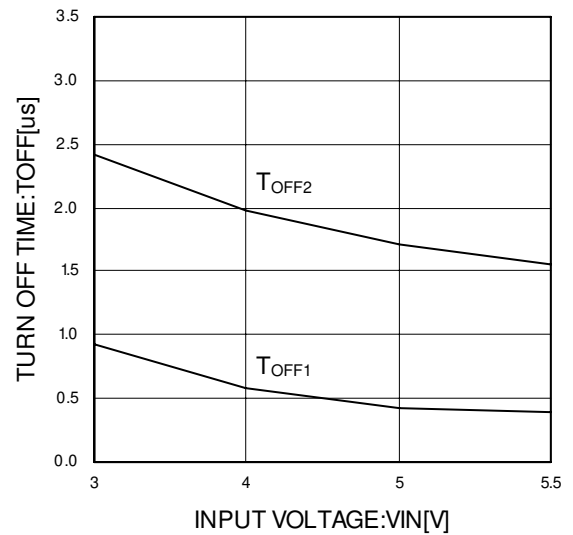

Figure 18. Switch fall time

● Typical Performance Curves - continued

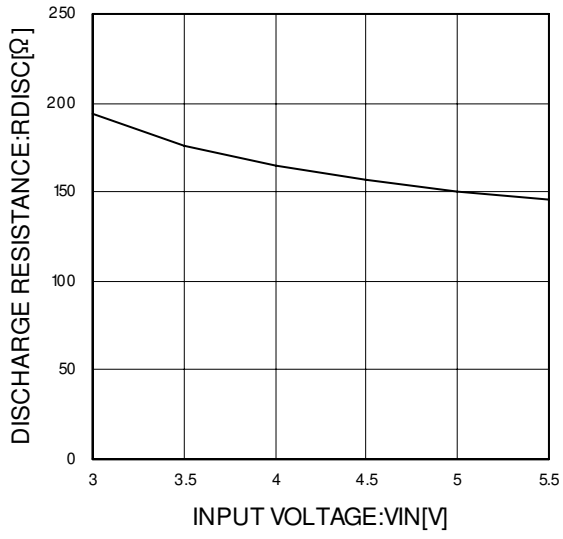

Figure 19. Discharge resistance

● Typical Wave Forms

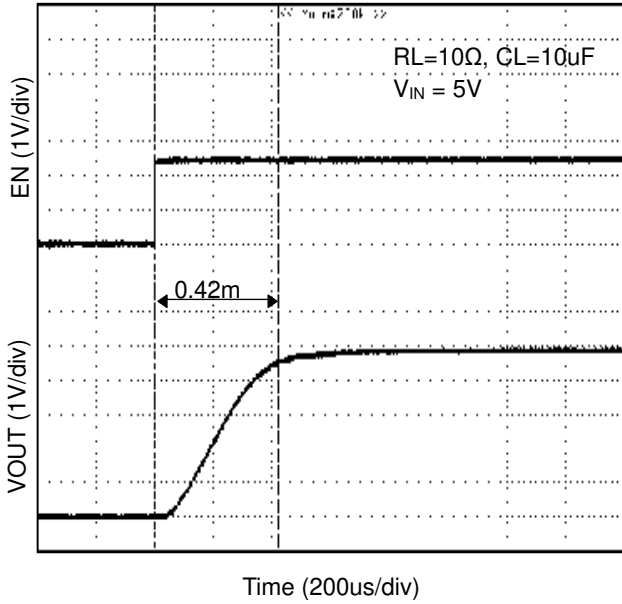

Figure 20. Switch rise time

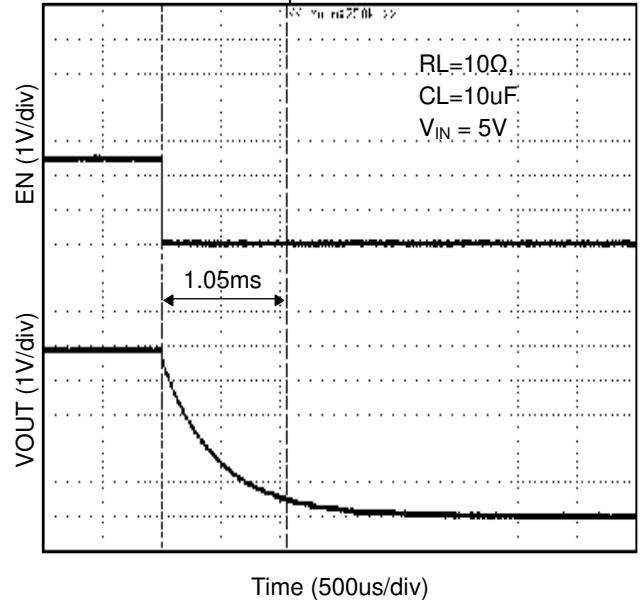

Figure 21. Switch fall time

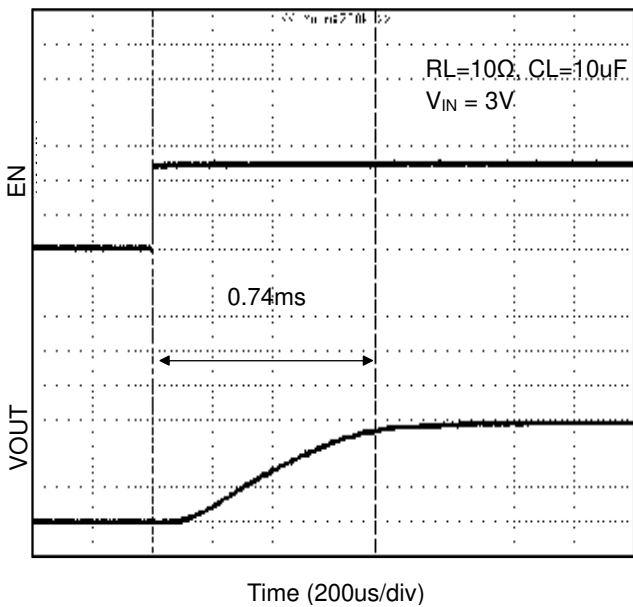

Figure 22. Switch rise time

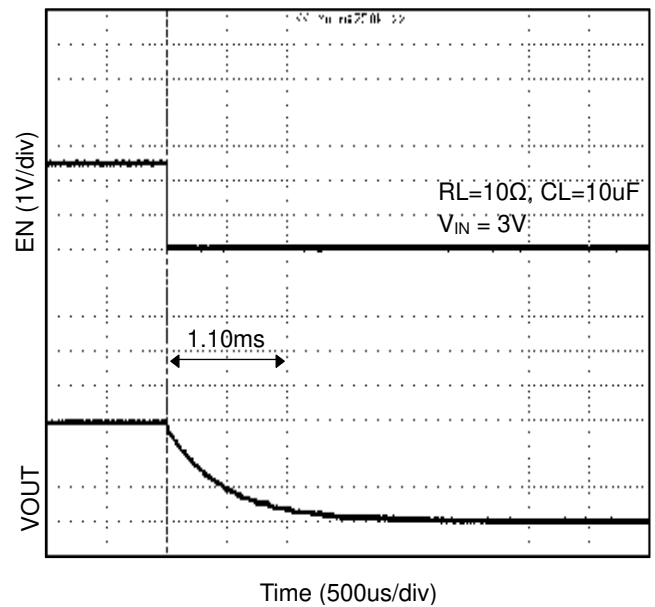

Figure 23. Switch fall time

● Typical Wave Forms – continued

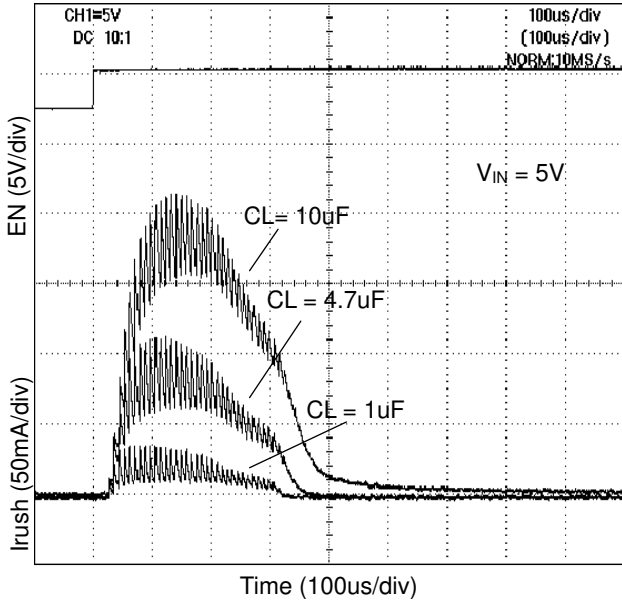

Figure 24. Inrush current

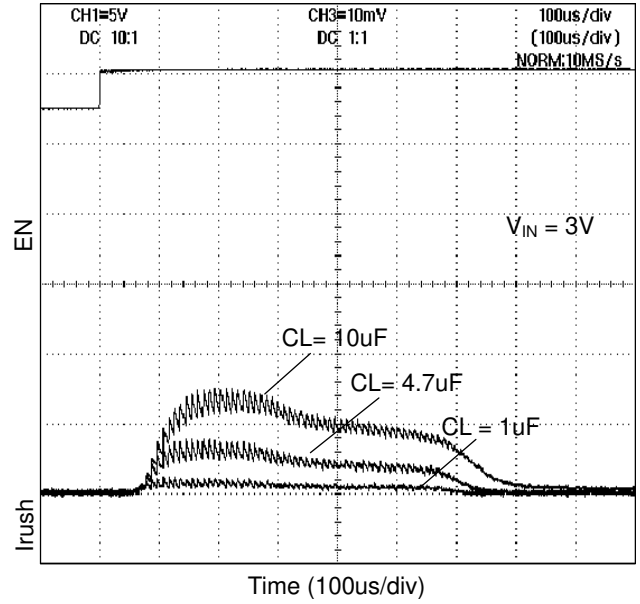

Figure 25. Inrush current

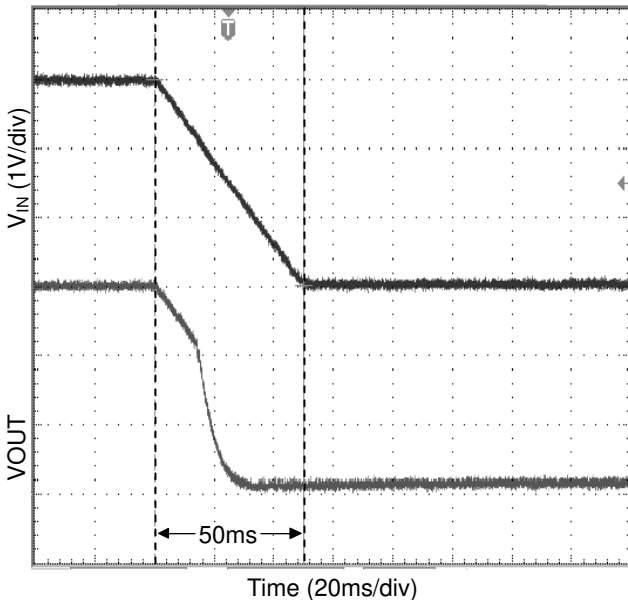

Figure 26. UVLO
 $CL = 10\mu F$

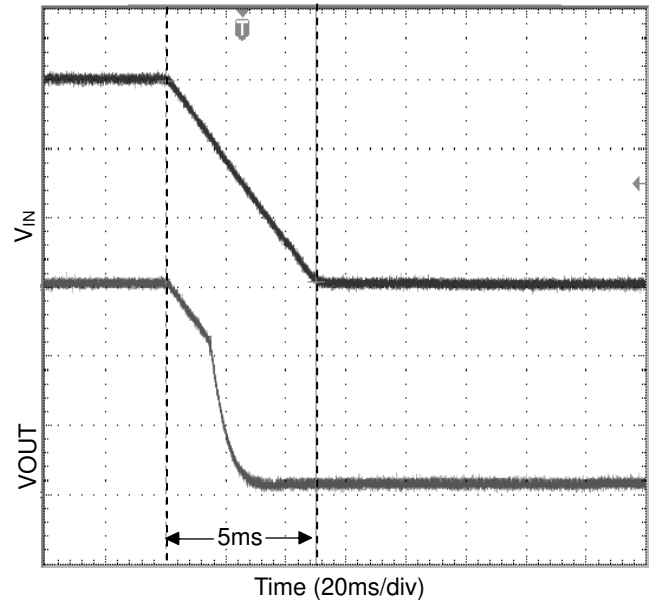
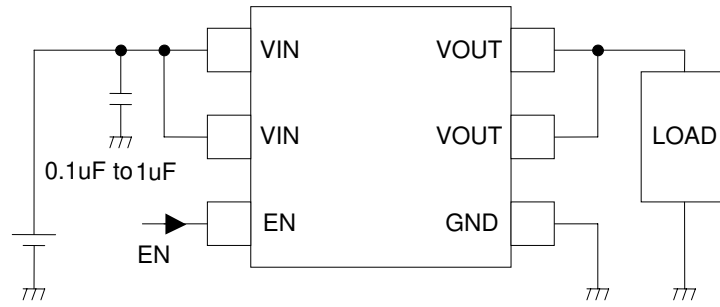

Figure 27. UVLO
 $CL = 1\mu F$

●Typical Application Circuit



●Functional Description

1. Input / output

VIN pin and VOUT pin are connected to the drain and the source of N-MOS switch respectively. VIN pin is also used as power source input to internal control circuit.

When EN input is set to High level and the switch is turned on, VIN pin and VOUT pin are connected by a 200mΩ switch. In a normal condition, current flows from VIN to VOUT. If voltage of VOUT is higher than VIN, current flows from VOUT to VIN, since the switch is bidirectional. There is no parasitic diode between the drain and the source, so it is possible to prevent current from flowing reversely from VOUT pin to VIN pin when the switch is disabled.

2. Discharge circuit

When the switch between the VIN and the VOUT is OFF, the 200Ω(Typ.) discharge switch between VOUT and GND turns on. By turning on this switch, electric charge at capacitive load is discharged.

3. Under voltage lockout (UVLO)

The UVLO circuit monitors the voltage of the VIN pin, when the EN input is active. UVLO circuit prevents the switch from turning on until the VIN exceeds 2.2V(Typ.). If the VIN drops below 2.1V(Typ.) while the switch turns on, then UVLO shuts off the switch.

While the switch between the VIN pin and VOUT pin is OFF due to UVLO operations, the switch of the discharge circuit turns on. However, when the voltage of VIN declines extremely, then the VOUT pin becomes Hi-Z.

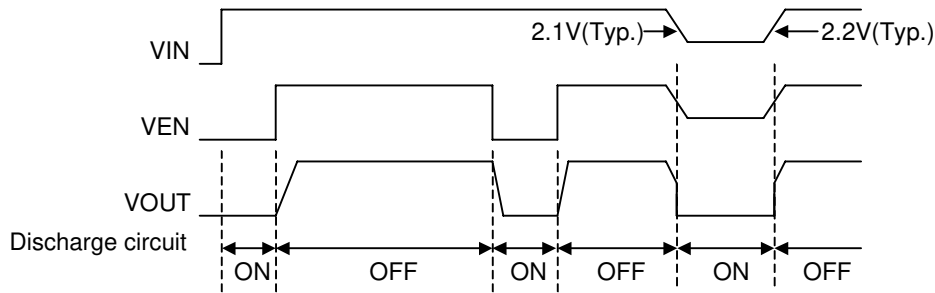

Figure 28. Operation timing

● Power Dissipation

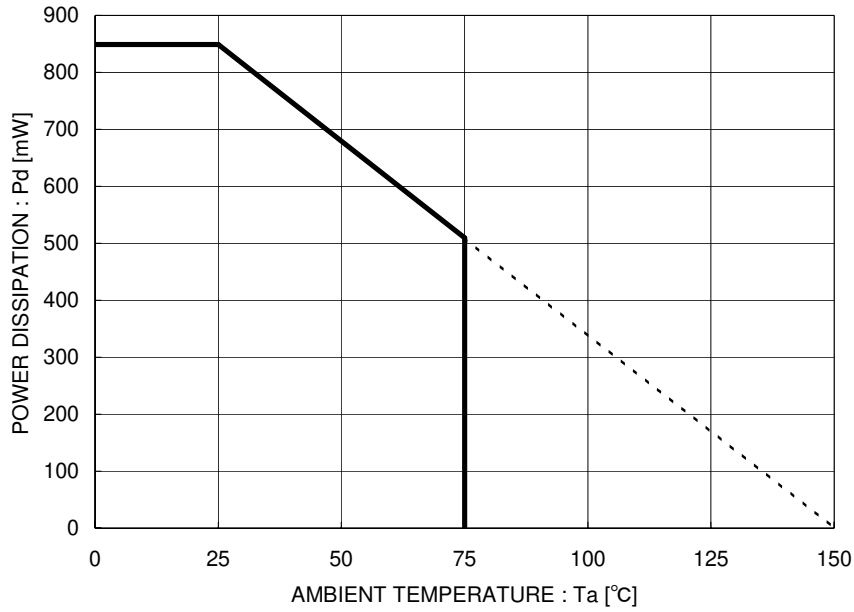
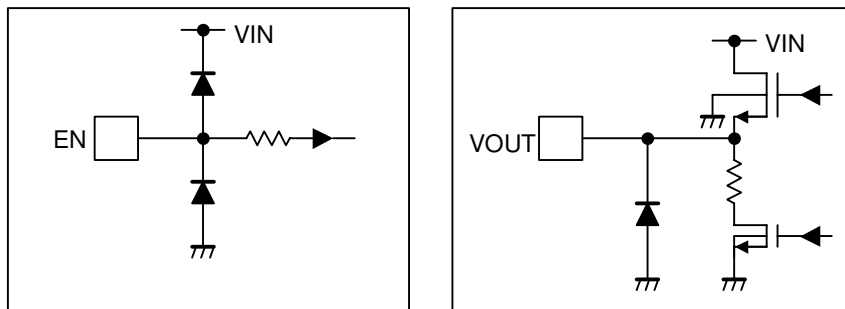

Figure 29. Power dissipation curve (Pd-Ta Curve) (HVSO6 package)

● I/O Equivalent Circuit



●Operational Notes

(1) Absolute Maximum Ratings

Operating the IC over the absolute maximum ratings may damage the IC. The damage can either be a short circuit between pins or an open circuit between pins. Therefore, it is important to consider circuit protection measures, such as adding a fuse, in case the IC is operated over the absolute maximum ratings

(2) Recommended operating conditions

These conditions represent a range within which the expected characteristics of the IC can be approximately obtained. The electrical characteristics are guaranteed under the conditions of each parameter.

(3) Reverse connection of power supply

Connecting the power supply in reverse polarity can damage the IC. Take precautions against reverse polarity when connecting the power supply, such as mounting an external diode between the power supply and the IC's power supply terminals.

(4) Power supply line

Design the PCB layout pattern to provide low impedance ground and supply lines. Separate the ground and supply lines of the digital and analog blocks to prevent noise in the ground and supply lines of the digital block from affecting the analog block. Furthermore, connect a capacitor to ground at all power supply pins. Consider the effect of temperature and aging on the capacitance value when using electrolytic capacitors.

(5) Ground Voltage

The voltage of the ground pin must be the lowest voltage of all pins of the IC at all operating conditions. Ensure that no pins are at a voltage below the ground pin at any time, even during transient condition.

(6) Short between pins and mounting errors

Be careful when mounting the IC on printed circuit boards. The IC may be damaged if it is mounted in a wrong orientation or if pins are shorted together. Short circuit may be caused by conductive particles caught between the pins.

(7) Operation under strong electromagnetic field

Operating the IC in the presence of a strong electromagnetic field may cause the IC to malfunction.

(8) Testing on application boards

When testing the IC on an application board, connecting a capacitor directly to a low-impedance output pin may subject the IC to stress. Always discharge capacitors completely after each process or step. The IC's power supply should always be turned off completely before connecting or removing it from the test setup during the inspection process. To prevent damage from static discharge, ground the IC during assembly and use similar precautions during transport and storage.

(9) Regarding input pins of the IC

This monolithic IC contains P⁺ isolation and P substrate layers between adjacent elements in order to keep them isolated. P-N junctions are formed at the intersection of the P layers with the N layers of other elements, creating a parasitic diode or transistor. For example (refer to figure below):

When GND > Pin A and GND > Pin B, the P-N junction operates as a parasitic diode.

When GND > Pin B, the P-N junction operates as a parasitic transistor.

Parasitic diodes inevitably occur in the structure of the IC. The operation of parasitic diodes can result in mutual interference among circuits, operational faults, or physical damage. Therefore, conditions that cause these diodes to operate, such as applying a voltage lower than the GND voltage to an input pin (and thus to the P substrate) should be avoided.

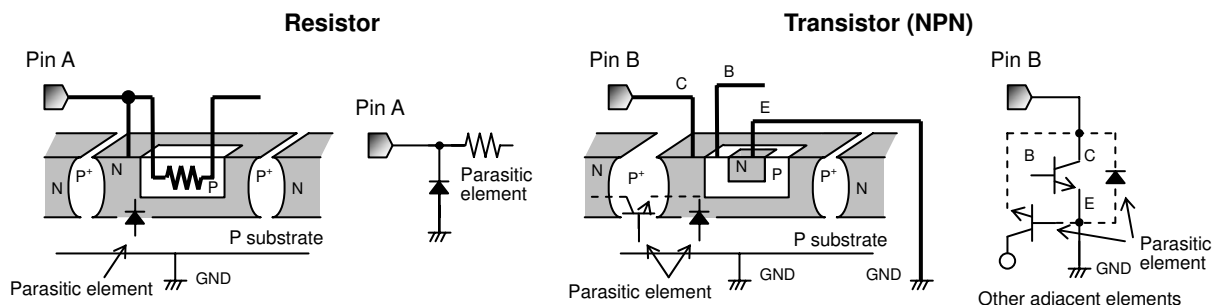

Example of monolithic IC structure

(10) GND wiring pattern

When using both small-signal and large-current GND traces, the two ground traces should be routed separately but connected to a single ground at the reference point of the application board to avoid fluctuations in the small-signal ground caused by large currents. Also ensure that the GND traces of external components do not cause variations on the GND voltage. The power supply and ground lines must be as short and thick as possible to reduce line impedance.

(11) External Capacitor

When using a ceramic capacitor, determine the dielectric constant considering the change of capacitance with temperature and the decrease in nominal capacitance due to DC bias and others.

(13) Thermal consideration

Use a thermal design that allows for a sufficient margin by taking into account the permissible power dissipation (Pd) in actual operating conditions. Consider Pc that does not exceed Pd in actual operating conditions ($P_c \geq P_d$).

Package Power dissipation : $P_d (W) = (T_{jmax} - T_a) / \theta_{ja}$

Power dissipation : $P_c (W) = (V_{cc} - V_o) \times I_o + V_{cc} \times I_b$

(T_{jmax} : Maximum junction temperature=150°C, T_a : Peripheral temperature[°C],
 θ_{ja} : Thermal resistance of package-ambience[°C/W], P_d : Package Power dissipation [W],
 P_c : Power dissipation [W], V_{cc} : Input Voltage, V_o : Output Voltage, I_o : Load, I_b : Bias Current)

●Ordering Information

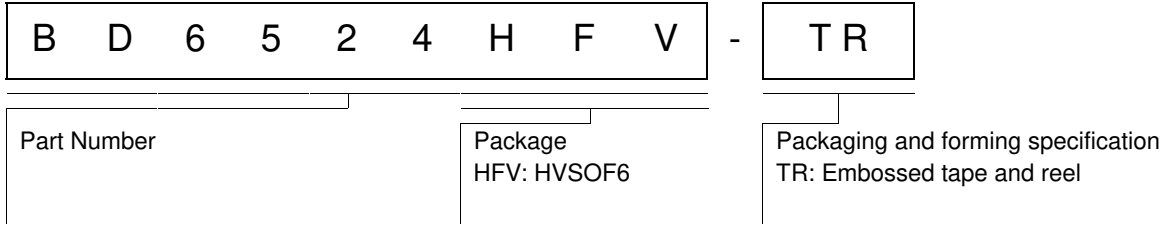

●Marking Diagram

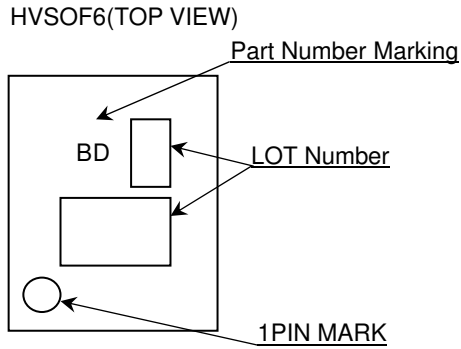

Part Number	Part Number Marking
BD6524HFV	BD

●Physical Dimension, Tape and Reel Information

Package Name	HVSOF6
--------------	--------

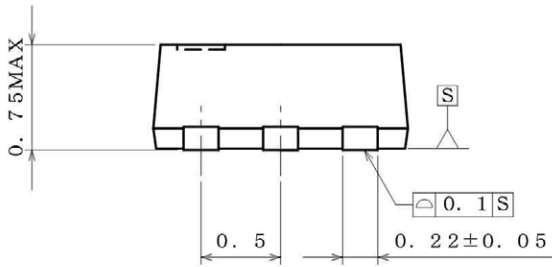
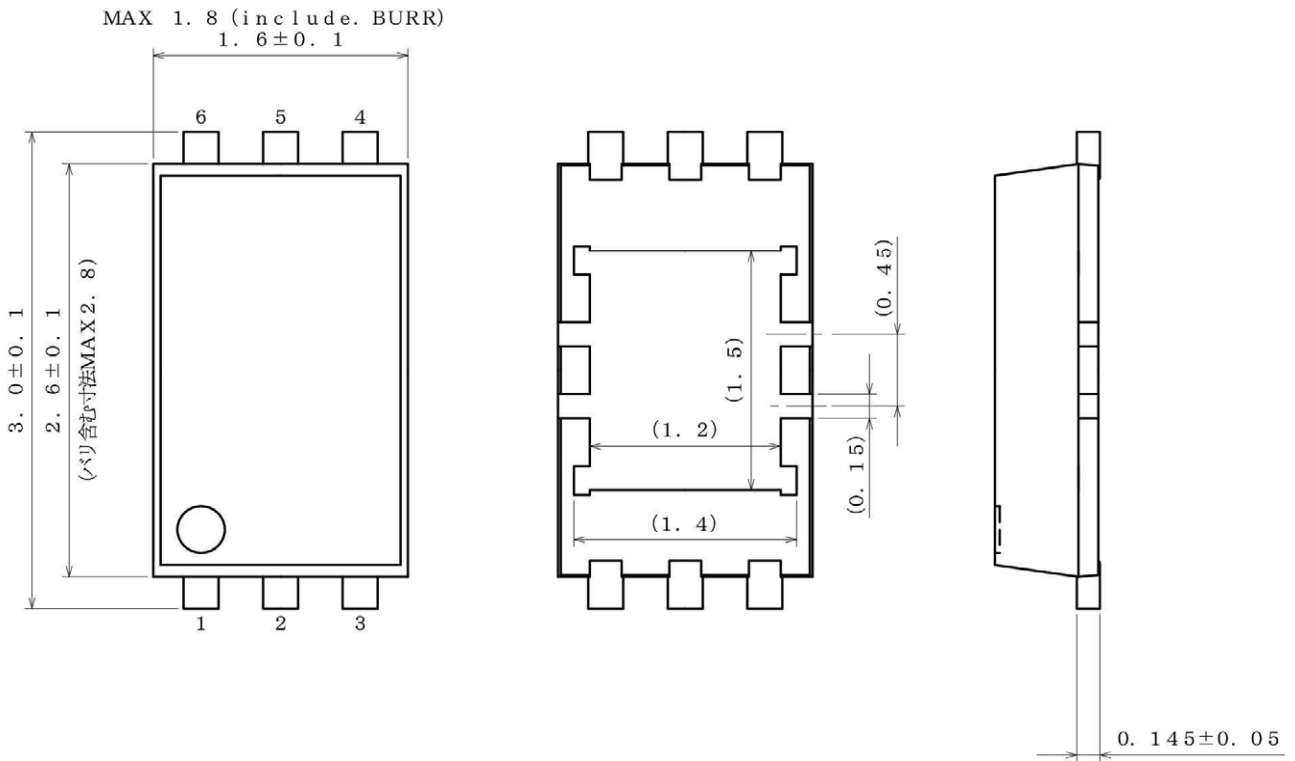

(UNIT : mm)
PKG : HVSOF6
Drawing No. EX162-5002

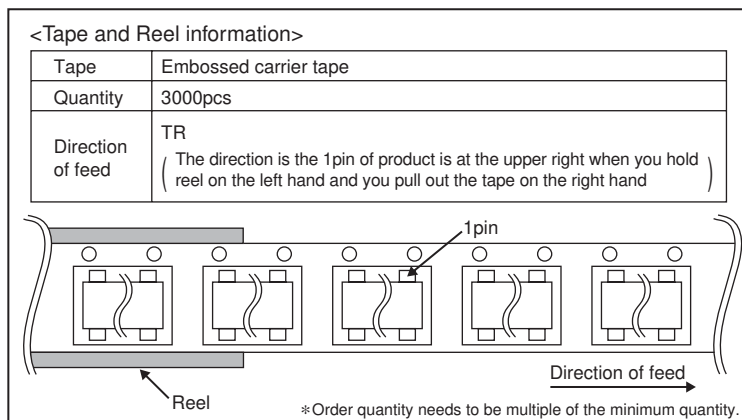

●Revision History

Date	Revision	Changes
11.Mar.2013	001	New Release

Notice

●General Precaution

- 1) Before you use our Products, you are requested to carefully read this document and fully understand its contents. ROHM shall not be in any way responsible or liable for failure, malfunction or accident arising from the use of any ROHM's Products against warning, caution or note contained in this document.
- 2) All information contained in this document is current as of the issuing date and subject to change without any prior notice. Before purchasing or using ROHM's Products, please confirm the latest information with a ROHM sales representative.

●Precaution on using ROHM Products

- 1) Our Products are designed and manufactured for application in ordinary electronic equipments (such as AV equipment, OA equipment, telecommunication equipment, home electronic appliances, amusement equipment, etc.). If you intend to use our Products in devices requiring extremely high reliability (such as medical equipment, transport equipment, traffic equipment, aircraft/spacecraft, nuclear power controllers, fuel controllers, car equipment including car accessories, safety devices, etc.) and whose malfunction or failure may cause loss of human life, bodily injury or serious damage to property ("Specific Applications"), please consult with the ROHM sales representative in advance. Unless otherwise agreed in writing by ROHM in advance, ROHM shall not be in any way responsible or liable for any damages, expenses or losses incurred by you or third parties arising from the use of any ROHM's Products for Specific Applications.
- 2) ROHM designs and manufactures its Products subject to strict quality control system. However, semiconductor products can fail or malfunction at a certain rate. Please be sure to implement, at your own responsibilities, adequate safety measures including but not limited to fail-safe design against the physical injury, damage to any property, which a failure or malfunction of our Products may cause. The following are examples of safety measures:
 - [a] Installation of protection circuits or other protective devices to improve system safety
 - [b] Installation of redundant circuits to reduce the impact of single or multiple circuit failure
- 3) Our Products are designed and manufactured for use under standard conditions and not under any special or extraordinary environments or conditions, as exemplified below. Accordingly, ROHM shall not be in any way responsible or liable for any damages, expenses or losses arising from the use of any ROHM's Products under any special or extraordinary environments or conditions. If you intend to use our Products under any special or extraordinary environments or conditions (as exemplified below), your independent verification and confirmation of product performance, reliability, etc. prior to use, must be necessary:
 - [a] Use of our Products in any types of liquid, including water, oils, chemicals, and organic solvents
 - [b] Use of our Products outdoors or in places where the Products are exposed to direct sunlight or dust
 - [c] Use of our Products in places where the Products are exposed to sea wind or corrosive gases, including Cl₂, H₂S, NH₃, SO₂, and NO₂
 - [d] Use of our Products in places where the Products are exposed to static electricity or electromagnetic waves
 - [e] Use of our Products in proximity to heat-producing components, plastic cords, or other flammable items
 - [f] Sealing or coating our Products with resin or other coating materials
 - [g] Use of our Products without cleaning residue of flux (even if you use no-clean type fluxes, cleaning residue of flux is recommended); or Washing our Products by using water or water-soluble cleaning agents for cleaning residue after soldering
 - [h] Use of the Products in places subject to dew condensation
- 4) The Products are not subject to radiation-proof design.
- 5) Please verify and confirm characteristics of the final or mounted products in using the Products.
- 6) In particular, if a transient load (a large amount of load applied in a short period of time, such as pulse) is applied, confirmation of performance characteristics after on-board mounting is strongly recommended. Avoid applying power exceeding normal rated power; exceeding the power rating under steady-state loading condition may negatively affect product performance and reliability.
- 7) De-rate Power Dissipation (Pd) depending on Ambient temperature (Ta). When used in sealed area, confirm the actual ambient temperature.
- 8) Confirm that operation temperature is within the specified range described in the product specification.
- 9) ROHM shall not be in any way responsible or liable for failure induced under deviant condition from what is defined in this document.

●Precaution for Mounting / Circuit board design

- 1) When a highly active halogenous (chlorine, bromine, etc.) flux is used, the residue of flux may negatively affect product performance and reliability.
- 2) In principle, the reflow soldering method must be used; if flow soldering method is preferred, please consult with the ROHM representative in advance.

For details, please refer to ROHM Mounting specification

●Precautions Regarding Application Examples and External Circuits

- 1) If change is made to the constant of an external circuit, please allow a sufficient margin considering variations of the characteristics of the Products and external components, including transient characteristics, as well as static characteristics.
- 2) You agree that application notes, reference designs, and associated data and information contained in this document are presented only as guidance for Products use. Therefore, in case you use such information, you are solely responsible for it and you must exercise your own independent verification and judgment in the use of such information contained in this document. ROHM shall not be in any way responsible or liable for any damages, expenses or losses incurred by you or third parties arising from the use of such information.

●Precaution for Electrostatic

This Product is electrostatic sensitive product, which may be damaged due to electrostatic discharge. Please take proper caution in your manufacturing process and storage so that voltage exceeding the Products maximum rating will not be applied to Products. Please take special care under dry condition (e.g. Grounding of human body / equipment / solder iron, isolation from charged objects, setting of Ionizer, friction prevention and temperature / humidity control).

●Precaution for Storage / Transportation

- 1) Product performance and soldered connections may deteriorate if the Products are stored in the places where:
 - [a] the Products are exposed to sea winds or corrosive gases, including Cl₂, H₂S, NH₃, SO₂, and NO₂
 - [b] the temperature or humidity exceeds those recommended by ROHM
 - [c] the Products are exposed to direct sunshine or condensation
 - [d] the Products are exposed to high Electrostatic
- 2) Even under ROHM recommended storage condition, solderability of products out of recommended storage time period may be degraded. It is strongly recommended to confirm solderability before using Products of which storage time is exceeding the recommended storage time period.
- 3) Store / transport cartons in the correct direction, which is indicated on a carton with a symbol. Otherwise bent leads may occur due to excessive stress applied when dropping of a carton.
- 4) Use Products within the specified time after opening a humidity barrier bag. Baking is required before using Products of which storage time is exceeding the recommended storage time period.

●Precaution for Product Label

QR code printed on ROHM Products label is for ROHM's internal use only.

●Precaution for Disposition

When disposing Products please dispose them properly using an authorized industry waste company.

●Precaution for Foreign Exchange and Foreign Trade act

Since our Products might fall under controlled goods prescribed by the applicable foreign exchange and foreign trade act, please consult with ROHM representative in case of export.

●Precaution Regarding Intellectual Property Rights

- 1) All information and data including but not limited to application example contained in this document is for reference only. ROHM does not warrant that foregoing information or data will not infringe any intellectual property rights or any other rights of any third party regarding such information or data. ROHM shall not be in any way responsible or liable for infringement of any intellectual property rights or other damages arising from use of such information or data.:
- 2) No license, expressly or implied, is granted hereby under any intellectual property rights or other rights of ROHM or any third parties with respect to the information contained in this document.

●Other Precaution

- 1) The information contained in this document is provided on an "as is" basis and ROHM does not warrant that all information contained in this document is accurate and/or error-free. ROHM shall not be in any way responsible or liable for any damages, expenses or losses incurred by you or third parties resulting from inaccuracy or errors of or concerning such information.
- 2) This document may not be reprinted or reproduced, in whole or in part, without prior written consent of ROHM.
- 3) The Products may not be disassembled, converted, modified, reproduced or otherwise changed without prior written consent of ROHM.
- 4) In no event shall you use in any way whatsoever the Products and the related technical information contained in the Products or this document for any military purposes, including but not limited to, the development of mass-destruction weapons.
- 5) The proper names of companies or products described in this document are trademarks or registered trademarks of ROHM, its affiliated companies or third parties.