



Chipsmall Limited consists of a professional team with an average of over 10 year of expertise in the distribution of electronic components. Based in Hongkong, we have already established firm and mutual-benefit business relationships with customers from,Europe,America and south Asia,supplying obsolete and hard-to-find components to meet their specific needs.

With the principle of "Quality Parts,Customers Priority,Honest Operation,and Considerate Service",our business mainly focus on the distribution of electronic components. Line cards we deal with include Microchip,ALPS,ROHM,Xilinx,Pulse,ON,Everlight and Freescale. Main products comprise IC,Modules,Potentiometer,IC Socket,Relay,Connector.Our parts cover such applications as commercial,industrial, and automotives areas.

We are looking forward to setting up business relationship with you and hope to provide you with the best service and solution. Let us make a better world for our industry!



Contact us

Tel: +86-755-8981 8866 Fax: +86-755-8427 6832

Email & Skype: info@chipsmall.com Web: www.chipsmall.com

Address: A1208, Overseas Decoration Building, #122 Zhenhua RD., Futian, Shenzhen, China



Load Switch ICs

BD6528HFV BD6529GUL

●General Description

A Power switch (BD6528HFV, BD6529GUL) for memory card Slot is a high side switch IC using an N-channel Power MOSFET. This switch IC has an ON resistance of 100mΩ for BD6529GUL; and 110mΩ for BD6528HFV. Operations using low input voltage ($V_{IN} \leq 2.7V$) are possible; made for various switch applications. BD6528HFV is available in space-saving HVSO6 package. BD6529GUL is available a space-saving VCSP-6 package.

●Features

- Built-in single N-channel MOSFET with Low On-Resistance (Typ. = 100mΩ)
- 500mA output current
- Low-voltage switching capability
- Soft-start function
- Output discharge circuit
- Reverse current flow blocking at switch off condition

●Applications

Memory card slots for Mobile phone, Digital still camera, PDA, MP3 player, PC, etc.

●Key Specifications

- Input voltage range: 2.7V to 4.5V
- ON resistance :

BD6528HFV	110mΩ(Typ.)
BD6529GUL	100mΩ(Typ.)
- Continuous current: 0.5 A
- Standby current: 0.01μA (Typ.)
- Operating temperature range: -25°C to +85°C

●Packages

- | | | | |
|----------|-----------------|-----------------|----------|
| HVSO6 | W(Typ.) | D(Typ.) | H (Max.) |
| VCSP50L1 | 1.60mm x 3.00mm | 3.00mm x 0.75mm | |
| | 1.50mm x 1.00mm | 1.00mm x 0.55mm | |

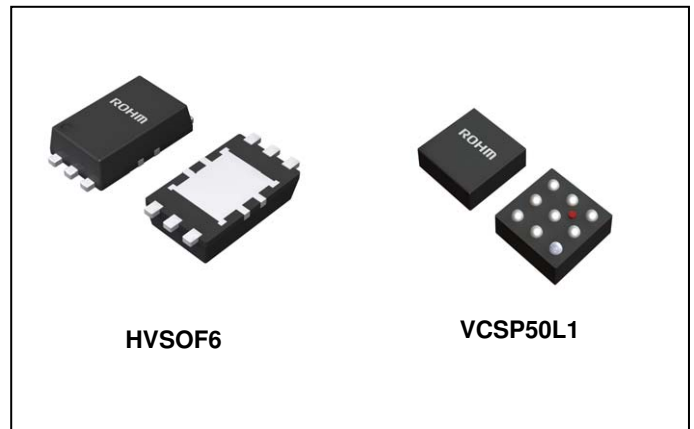

●Typical Application Circuit

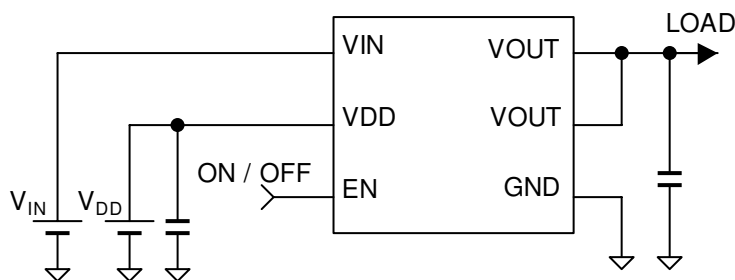

●Lineup

ON resistance (Typ.)	Control input logic	Package		Orderable Part Number
110mΩ	High	HVSO6	Reel of 3000	BD6528HFV-TR
100mΩ	High	VCSP50L1	Reel of 3000	BD6529GUL-E2

●Block Diagram

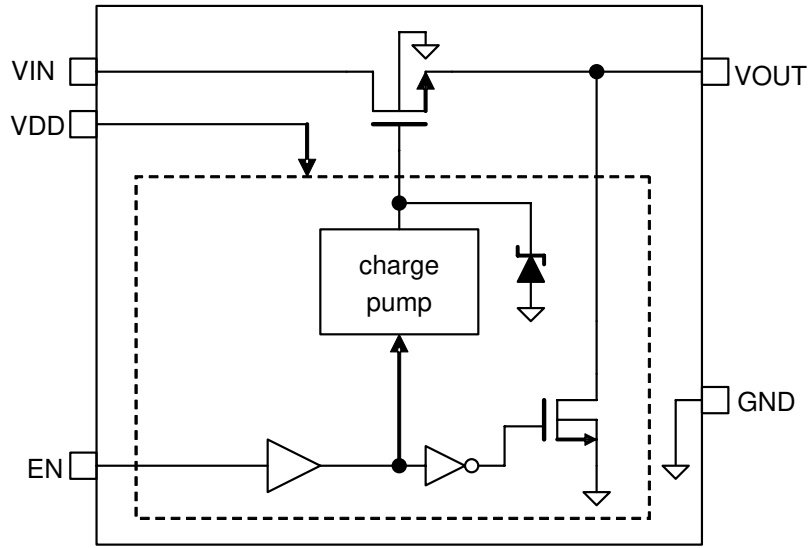

●Pin Configurations

B	VIN	VOUT	VOUT
A	VDD	EN	GND
	1	2	3

BD6529GUL (Bottom view)

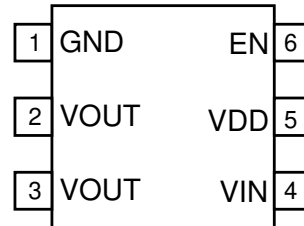

BD6528HFV (Top view)

●Pin Description

Pin number	Pin name	Pin function
1 (A3)	GND	Ground
2, 3 (B2, B3)	VOUT	Switch output (connect each pin externally)
4 (B1)	VIN	Switch input
5 (A1)	VDD	Power supply (for switch control and drive circuit)
6 (A2)	EN	Enable input (Active-High input)

● Absolute Maximum Ratings

Parameter	Symbol	Ratings	Unit
Supply voltage	VDD	-0.3 to 6.0	V
VIN voltage	VIN	-0.3 to 6.0	V
EN voltage	VEN	-0.3 to VDD + 0.3	V
VOUT voltage	VOUT	-0.3 to 6.0	V
Storage temperature	TSTG	-55 to 150	°C
Power dissipation	Pd	849 * ¹ (BD6528HFV)	mW
		575 * ² (BD6529GUL)	

*1 When mounted on 70mm * 70mm * 1.6mm Glass-epoxy PCB, derate by 6.8mW / °C at Ta > 25°C

*2 When mounted on 50mm * 58mm * 1.75mm Glass-epoxy PCB, Derate by 4.6mW / °C at Ta > 25°C

● Recommended Operating Conditions

Parameter	Symbol	Ratings			Unit
		Min.	Typ.	Max.	
Operating voltage	VDD	2.7	3.3	4.5	V
Switch input voltage	VIN	0	1.2	2.7	V
Operation temperature	TOPR	-25	25	85	°C
Output current	ILO	0	-	500	mA

● Electrical Characteristics

OBD6528HFV (unless otherwise specified, VDD = 3.3V, VIN = 1.2V, Ta = 25°C)

Parameter	Symbol	Limits			Unit	Condition
		Min.	Typ.	Max.		
[Current consumption]						
Operating current	IDD	-	20	30	μA	VEN = 1.2V
Standby current	ISTB	-	0.01	1	μA	VEN = 0V
[I/O]						
EN input voltage	VENH	1.2	-	-	V	High level input
	VENL	-	-	0.4	V	Low level input
EN input current	IEN	-1	-	1	μA	VEN = 0V or VEN = 1.2V
[Power switch]						
On-resistance	RON	-	110	-	mΩ	IOUT = 500mA
Switch leakage current	I _{LEAK}	-	0.01	10	μA	VEN = 0V, VOUT = 0V
Output rise time	TON1	-	0.5	1	ms	RL = 10Ω, VOUT 10% → 90%
Output turn-on time	TON2	-	0.6	2	ms	RL = 10Ω, VEN High → VOUT 90%
Output fall time	TOFF1	-	1	20	μs	RL = 10Ω, VOUT 90% → 10%
Output turn-off time	TOFF2	-	15	100	μs	RL = 10Ω, VEN Low → VOUT 10%
[Discharge circuit]						
Discharge on-resistance	RDISC	-	70	110	Ω	IOUT = -1mA, VEN = 0V
Discharge current	IDISC	-	15	20	mA	VOUT = 3.3V, VEN = 0V

OBD6529GUL(unless otherwise specified, VDD =3.3V, VIN = 1.2V, Ta = 25°C)

Parameter	Symbol	Limits			Unit	Condition
		Min.	Typ.	Max.		
[Current consumption]						
Operating current	IDD	-	20	30	μA	VEN = 1.2V
Standby current	ISTB	-	0.01	1	μA	VEN = 0V
[I/O]						
EN input voltage	VENH	1.2	-	-	V	High level input
	VENL	-	-	0.4	V	Low level input
EN input current	IEN	-1	-	1	μA	VEN = 0V or VEN = 1.2V
[Power switch]						
On Resistance	RON	-	100	-	mΩ	IOUT = 500mA
Switch leakage current	I _{LEAK}	-	0.01	10	μA	VEN = 0V, VOUT = 0V
Output turn on rise time	TON1	-	0.5	1	ms	RL = 10Ω, VOUT 10% → 90%
Output turn on time	TON2	-	0.6	2	ms	RL = 10Ω, VEN High → VOUT 90%
Output turn off fall time	TOFF1	-	0.1	4	μs	RL = 10Ω, VOUT 90% → 10%
Output turn off time	TOFF2	-	1	6	μs	RL = 10Ω, VEN Low → VOUT 10%
[Discharge circuit]						
Discharge on-resistance	RDISC	-	70	110	Ω	IOUT = -1mA, VEN = 0V
Discharge current	IDISC	-	15	20	mA	VOUT = 3.3V, VEN = 0V

●Measurement Circuit

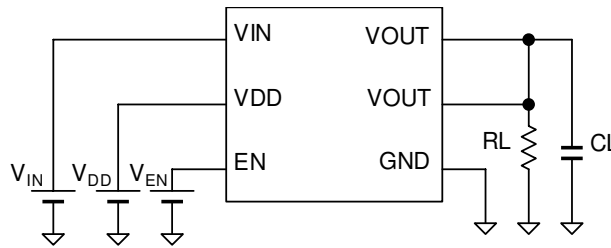

●Timing Diagram

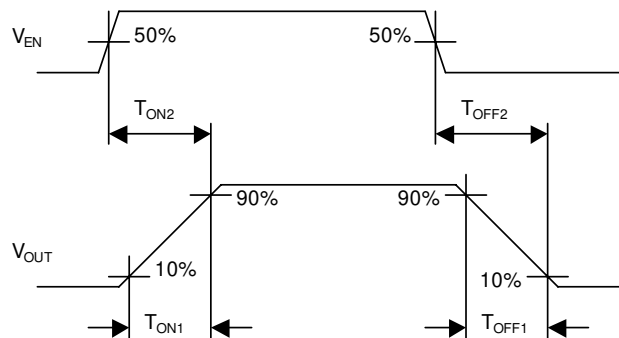

● Typical Performance Curves

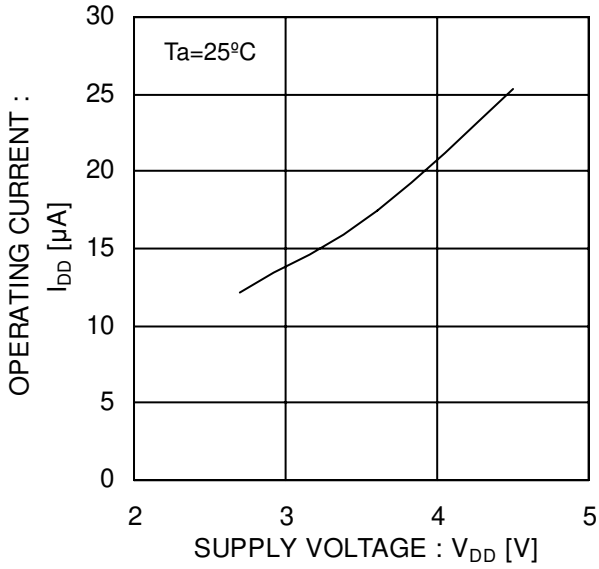

Figure 1. Operating current EN enable

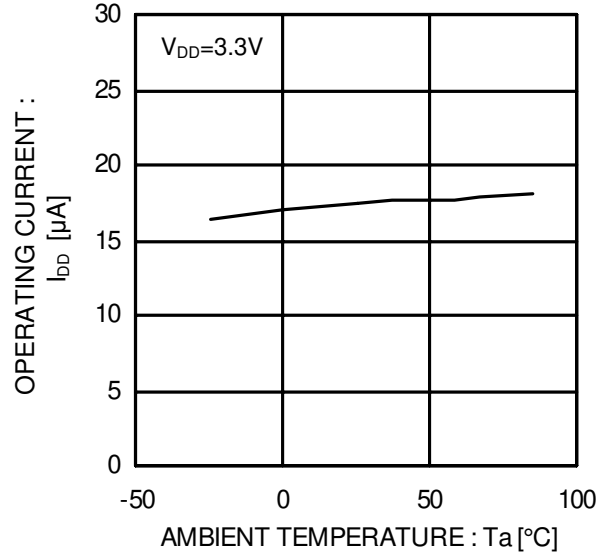

Figure 2. Operating current EN enable

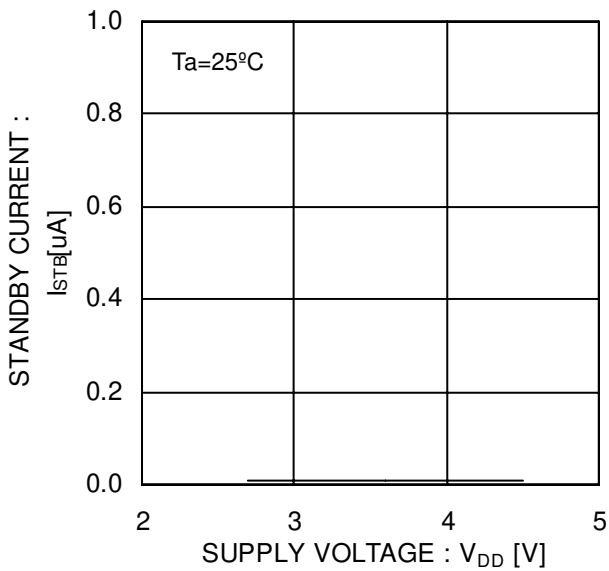

Figure 3. Standby current EN disable

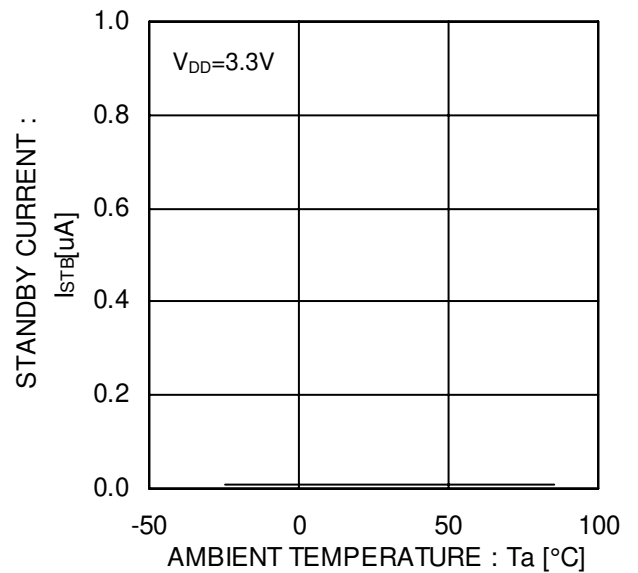

Figure 4. Standby current EN disable

● Typical Performance Curves - continued

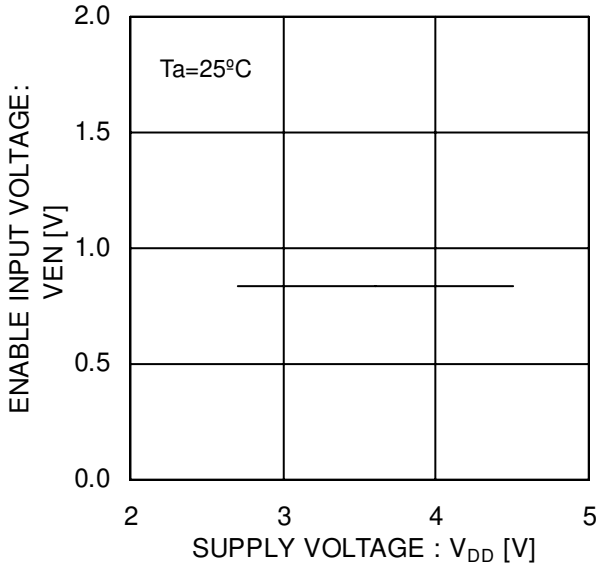

Figure 5. EN input voltage

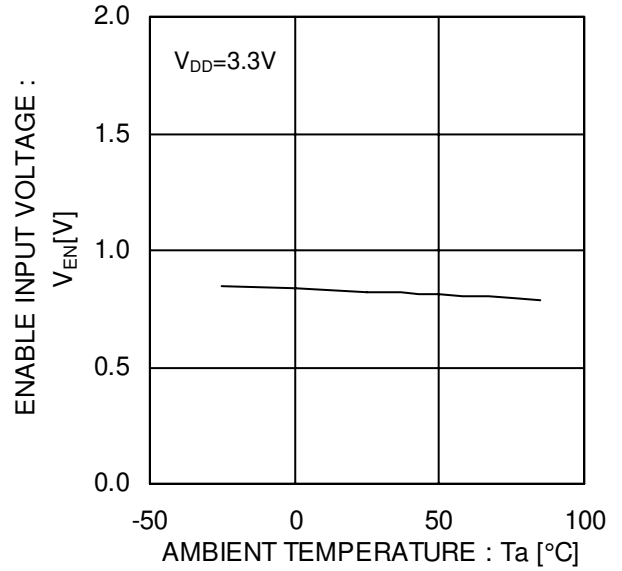

Figure 6. EN input voltage

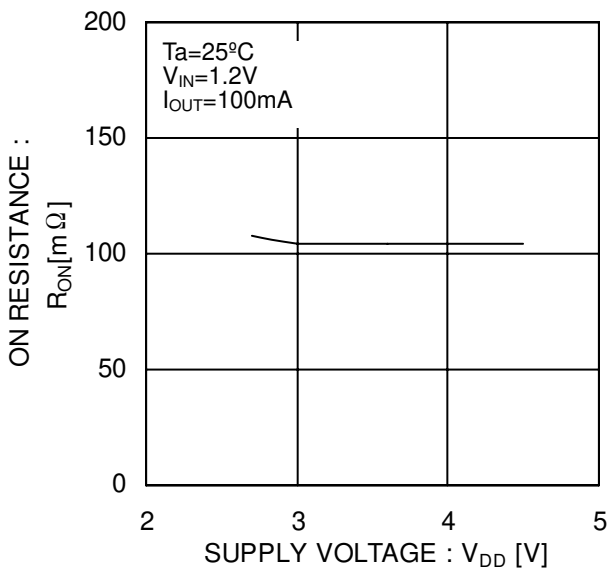

Figure 7. On-resistance vs. V_{DD} (BD6528HFV)

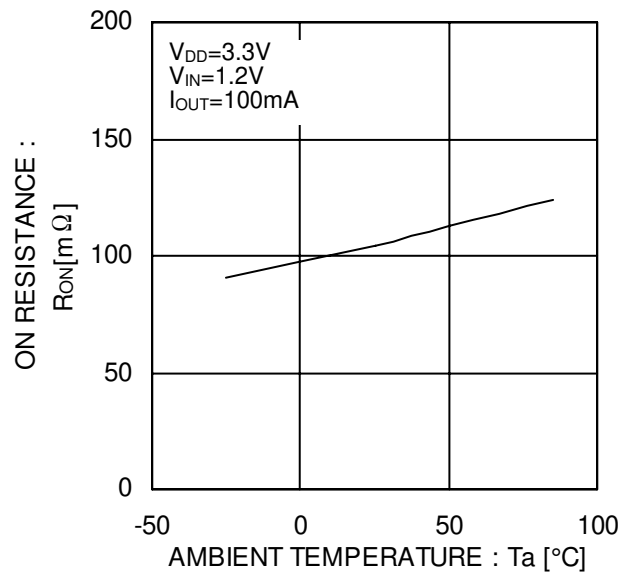

Figure 8. On-resistance vs. temperature (BD6528HFV)

● Typical Performance Curves - continued

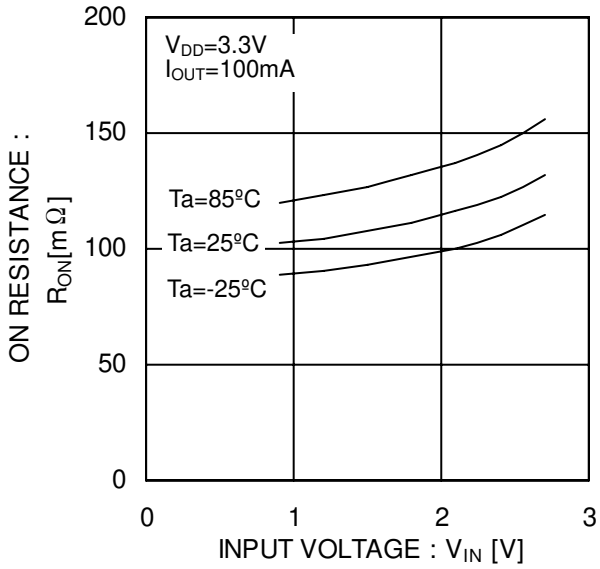

Figure 9. On-resistance vs. VIN (BD6528HFV)

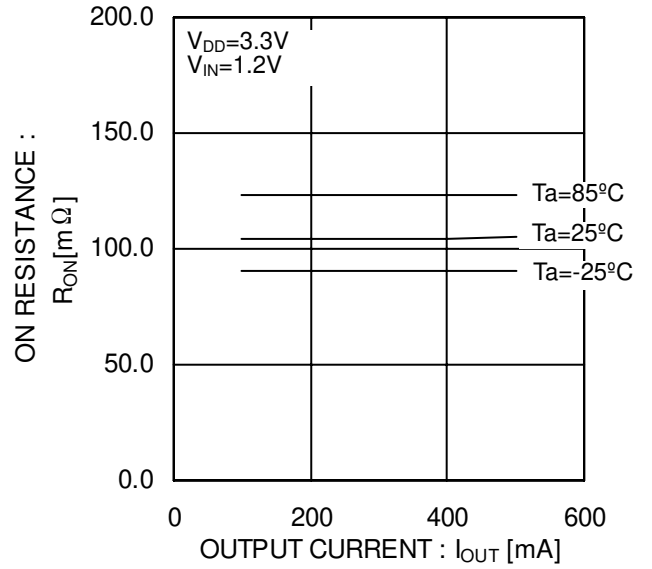

Figure 10. On-resistance vs. IOUT (BD6528HFV)

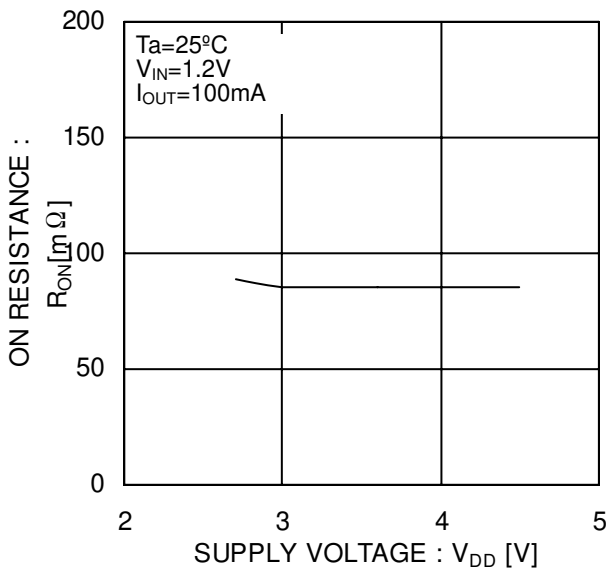

Figure 11. On-resistance vs. VDD (BD6529GUL)

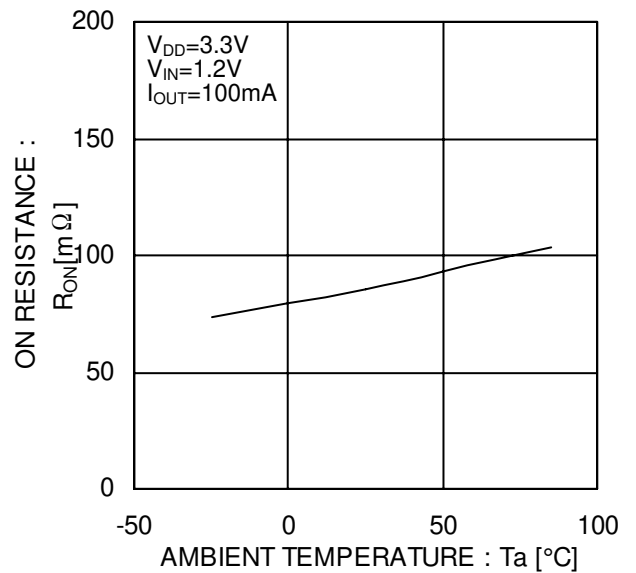

Figure 12. On-resistance vs. temperature (BD6529GUL)

● Typical Performance Curves - continued

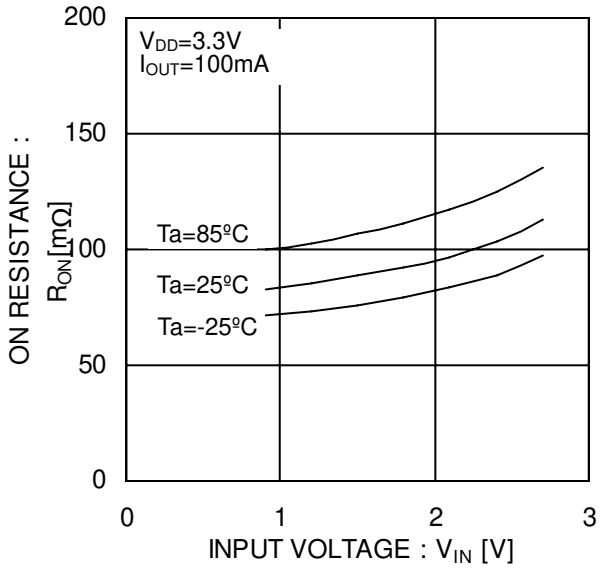

Figure 13. On-resistance vs. V_{IN} (BD6529GUL)

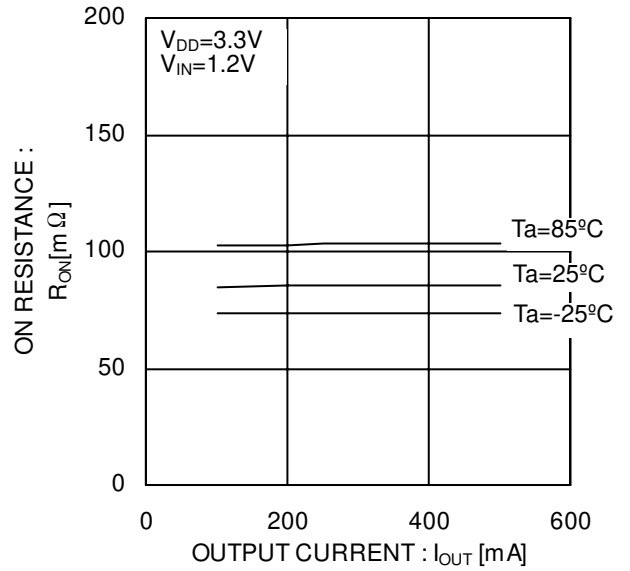

Figure 14. On-resistance vs. I_{OUT} (BD6529GUL)

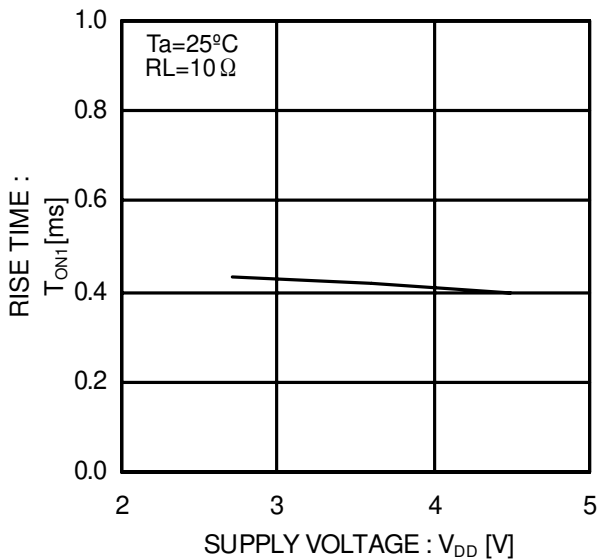

Figure 15. Output rise time

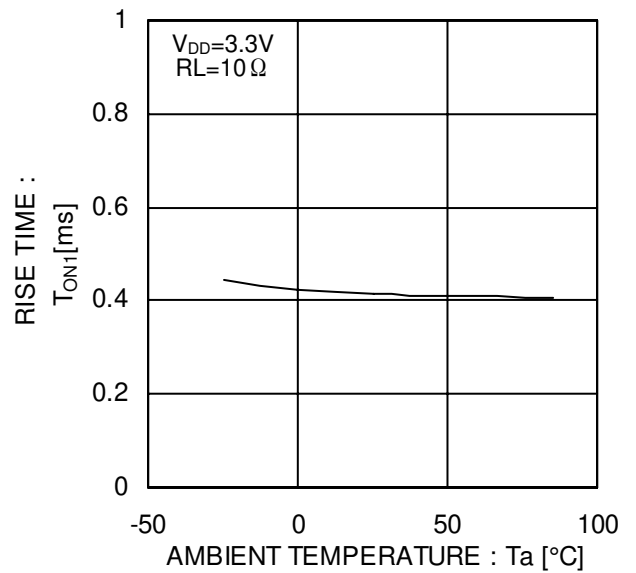

Figure 16. Output rise time

● Typical Performance Curves - continued

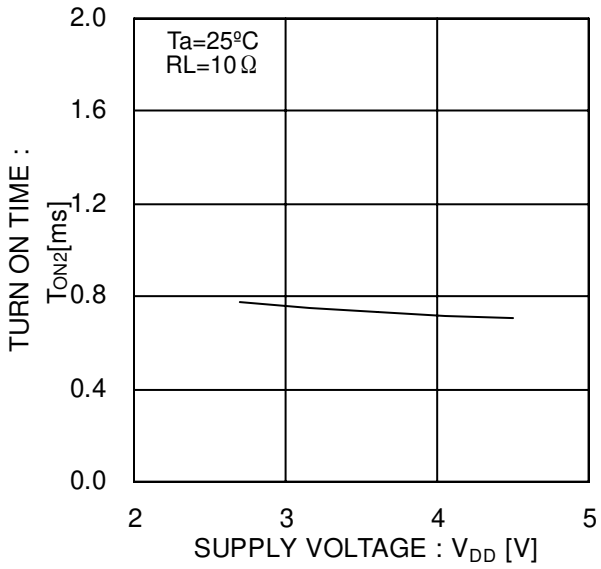

Figure 17. Output turn-on time

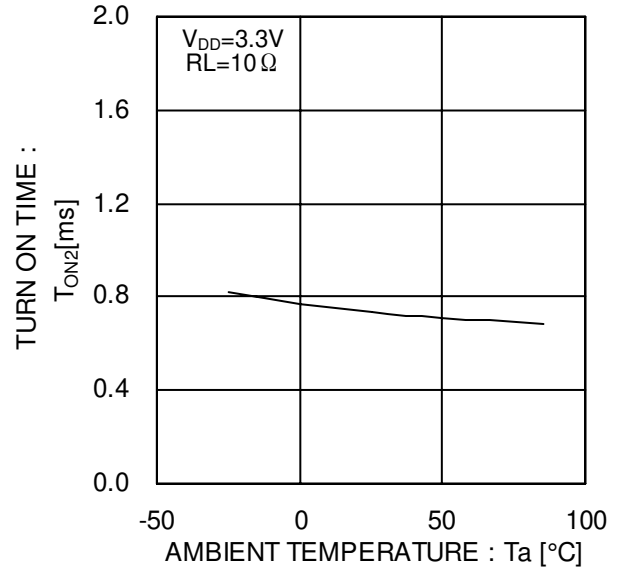

Figure 18. Output turn-on time

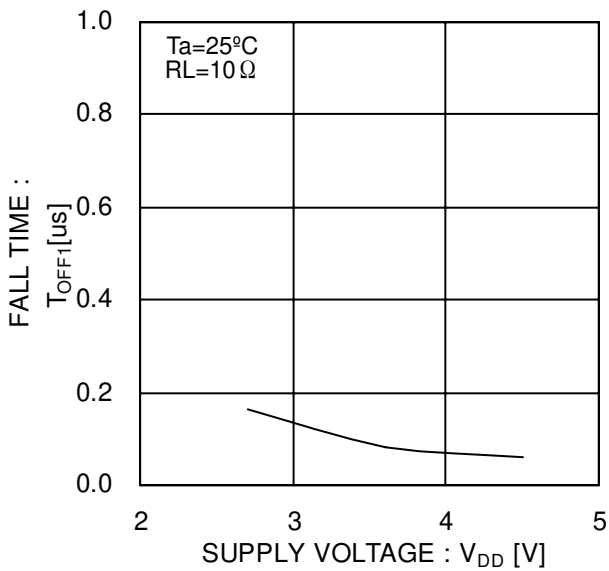

Figure 19. Output fall time

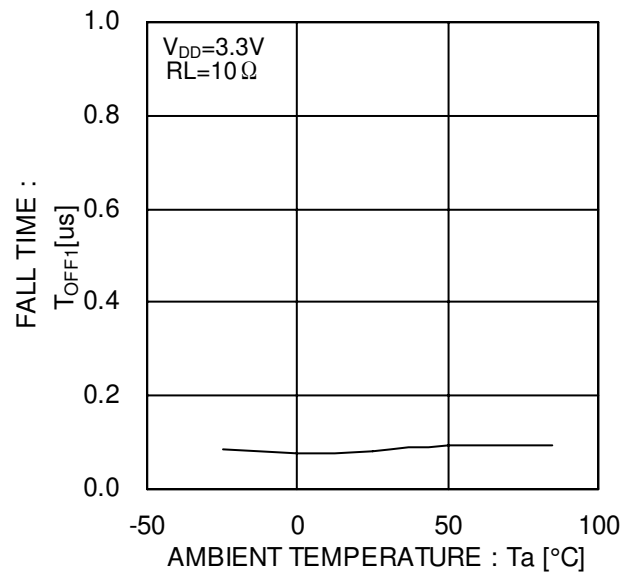

Figure 20. Output fall time

● Typical Performance Curves - continued

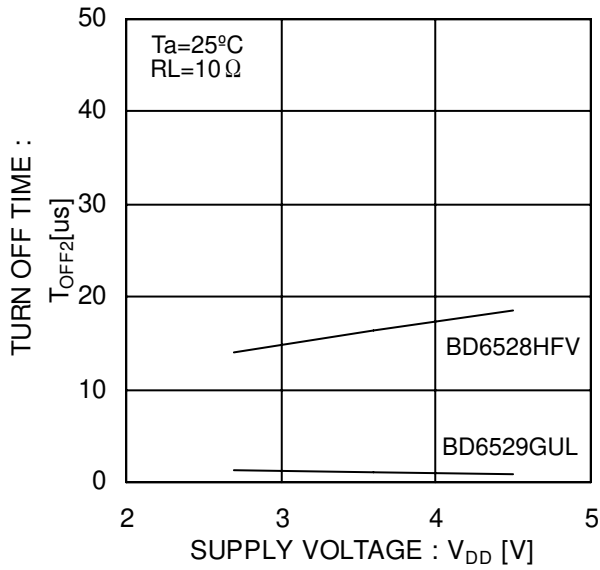

Figure 21. Output turn-off time

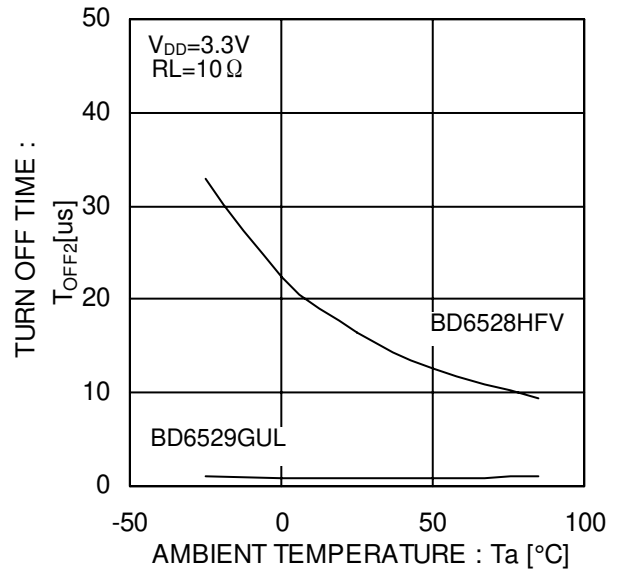

Figure 22. Output turn-off time

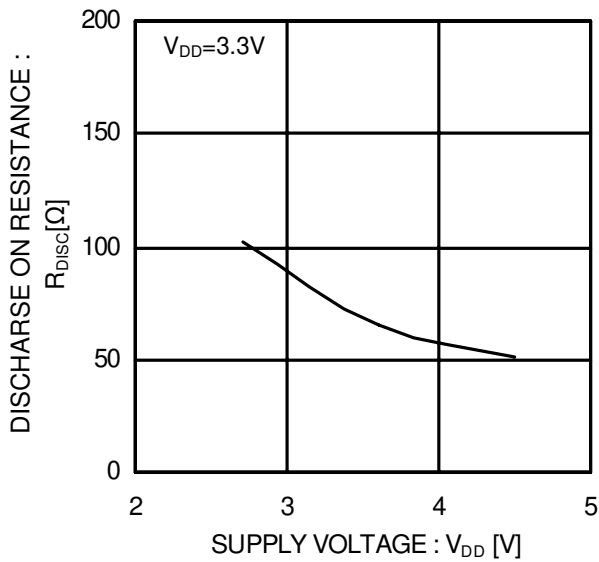

Figure 23. Discharge on-resistance

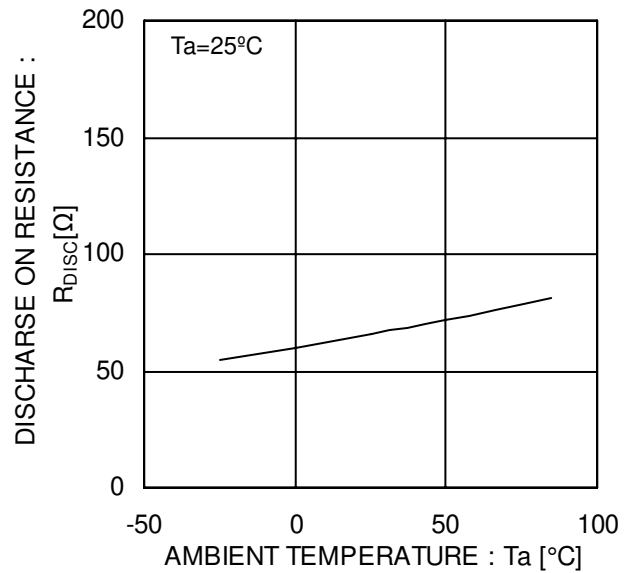
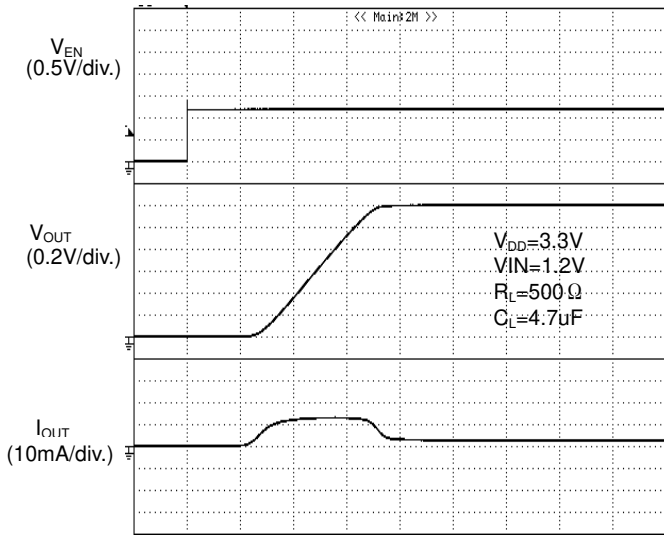
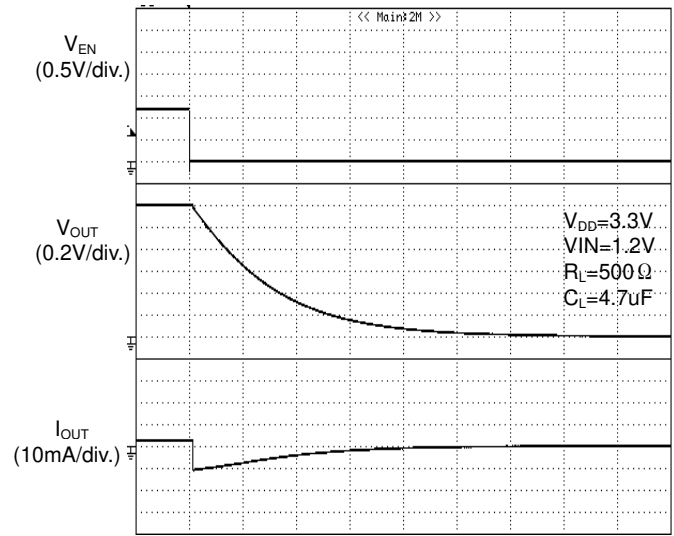

Figure 24. Discharge on-resistance

● Typical Wave Forms



TIME (0.2ms/div.)
Figure 25. Output turn-on response
BD6528HFV



TIME (0.2ms/div.)
Figure 26. Output turn-off response
BD6528HFV

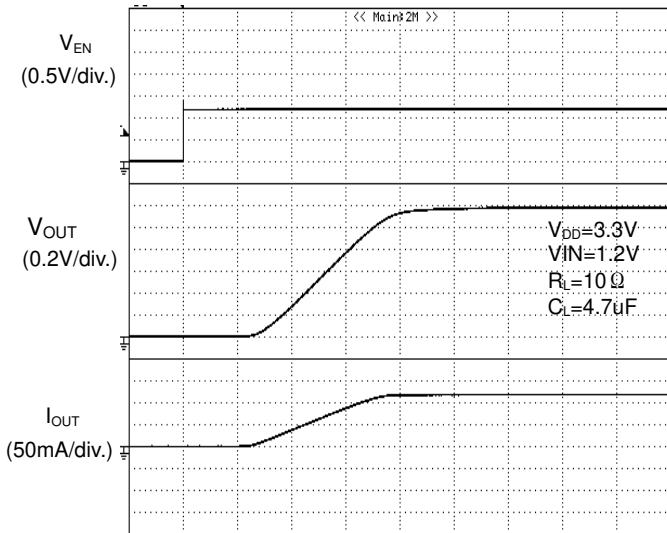

TIME (0.2ms/div.)
Figure 27. Output turn-on response
BD6528HFV

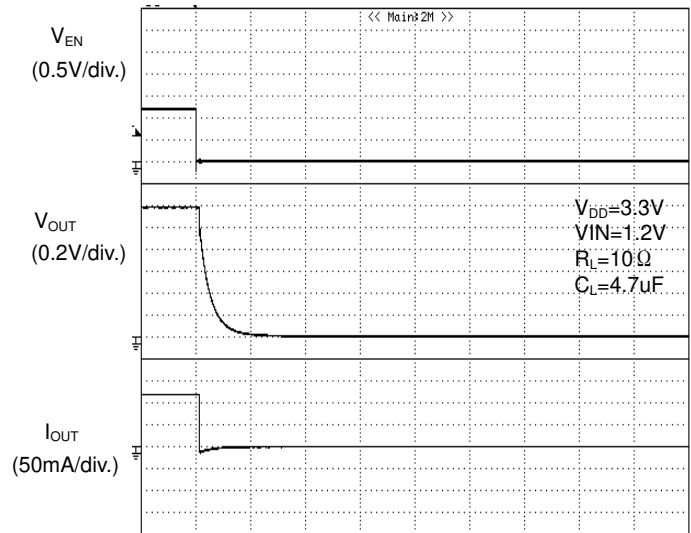

TIME (0.2ms/div.)
Figure 28. Output turn-off response
BD6528HFV

● Typical Wave Forms - continued

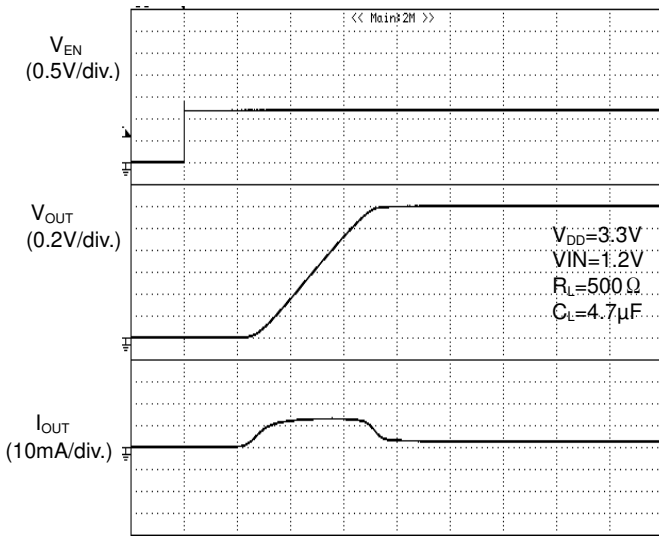

TIME (0.2ms/div.)
Figure 29. Output turn-on response
BD6529GUL

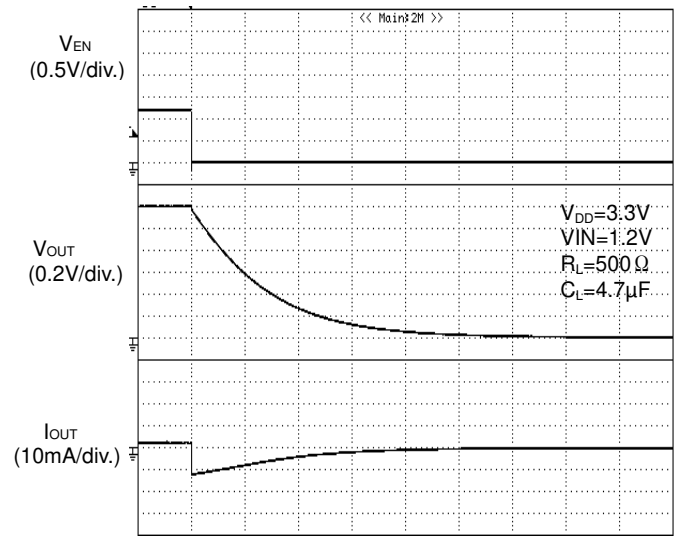

TIME (0.2ms/div.)
Figure 30. Output turn-off response
BD6529GUL

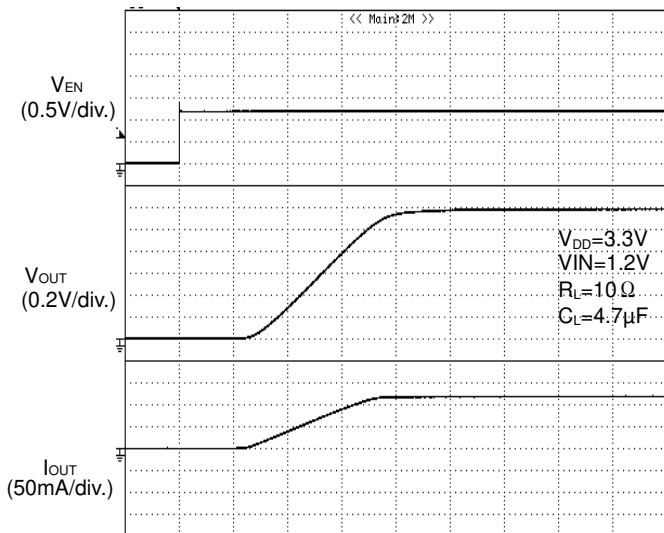

TIME (0.2ms/div.)
Figure 31. Output turn-on response
BD6529GUL

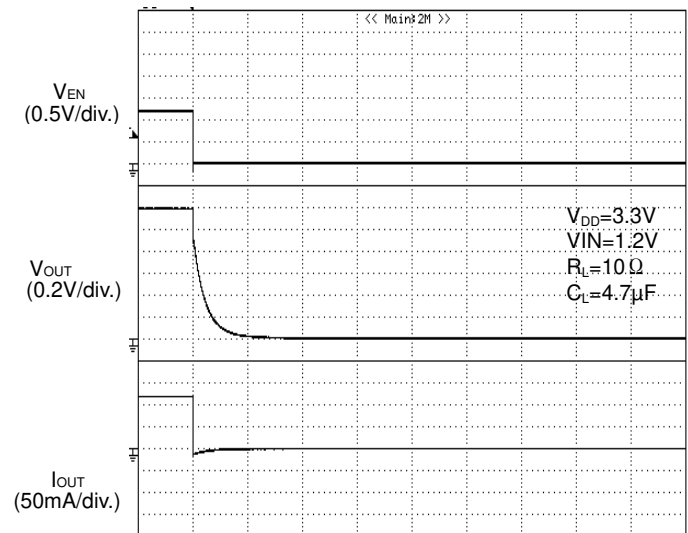

TIME (0.2ms/div.)
Figure 32. Output turn-off response
BD6529GUL

● Typical Wave Forms - continued

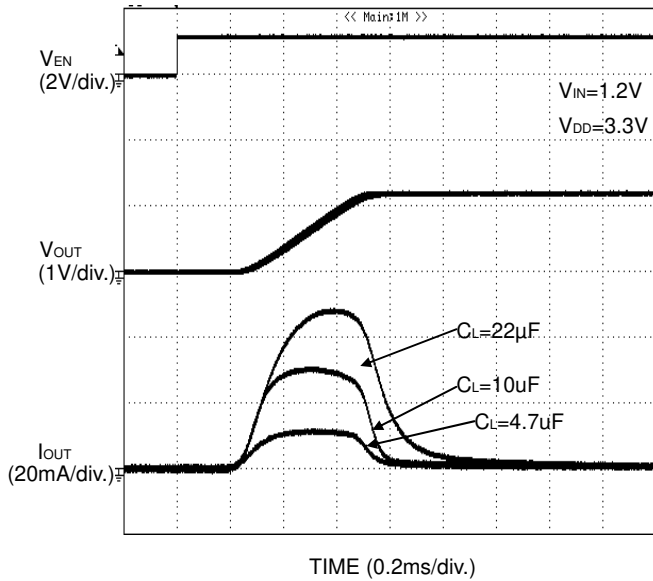
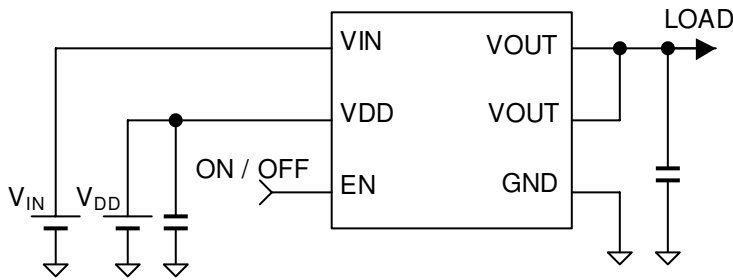

Figure 33. Rush current response

●Typical Application Circuit



* This application circuit does not guarantee its operation. When the recommended external circuit components are changed, be sure to consider adequate margins by taking into account external parts and/or IC's dispersion including not only static characteristics, but also transient characteristics.

●Functional Description

1. Switch operation

Each VIN and VOUT pins are connected to MOSFET's drain and source respectively. By setting EN input to High level, the internal charge pump operates and turns on the MOSFET. When MOSFET is turned on, the switch's operation becomes bidirectional. Consequently, in case of $V_{IN} < V_{OUT}$, the current is flowing from VOUT to VIN. Since there is no parasitic diode between switch's drain and source, it prevents the reverse flow of current from VOUT to VIN at switch off condition.

2. Output discharge circuit

Discharge circuit operates when the switch is off. When discharge circuit operates, 70Ω (Typ.) resistor is connected between VOUT pin and GND pin. This discharges the electrical charge quickly.

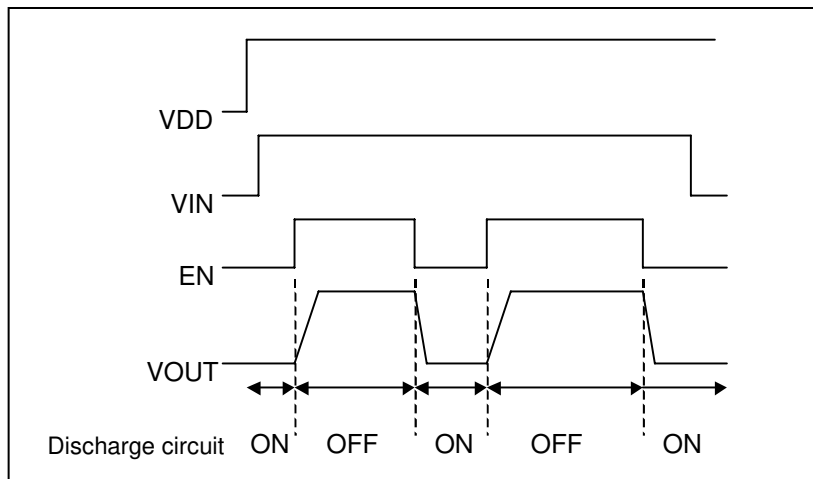

Figure 34. Operation timing

● Power Dissipation

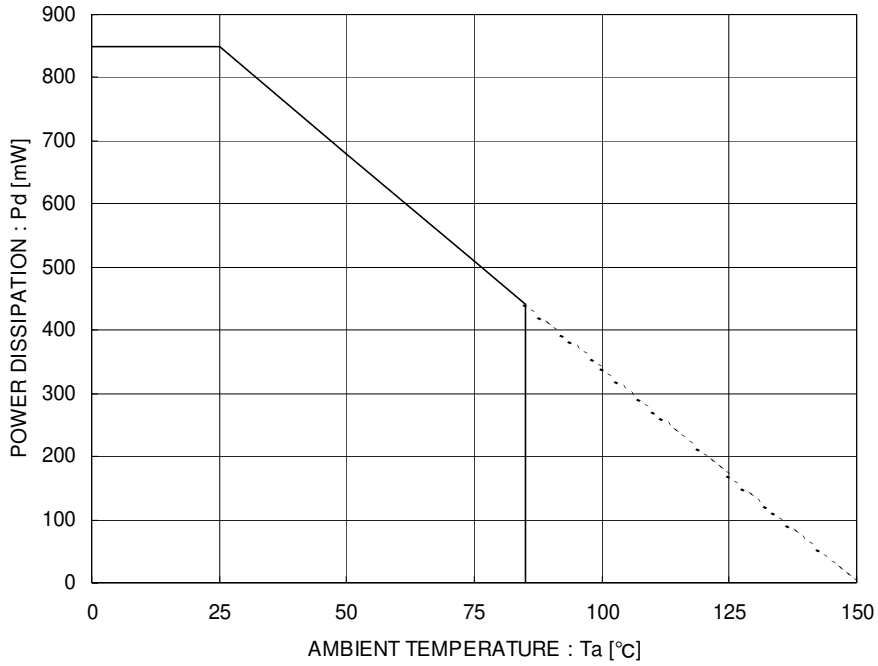

Figure 35. Power dissipation curve (Pd-Ta Curve) (HVSO6 package)

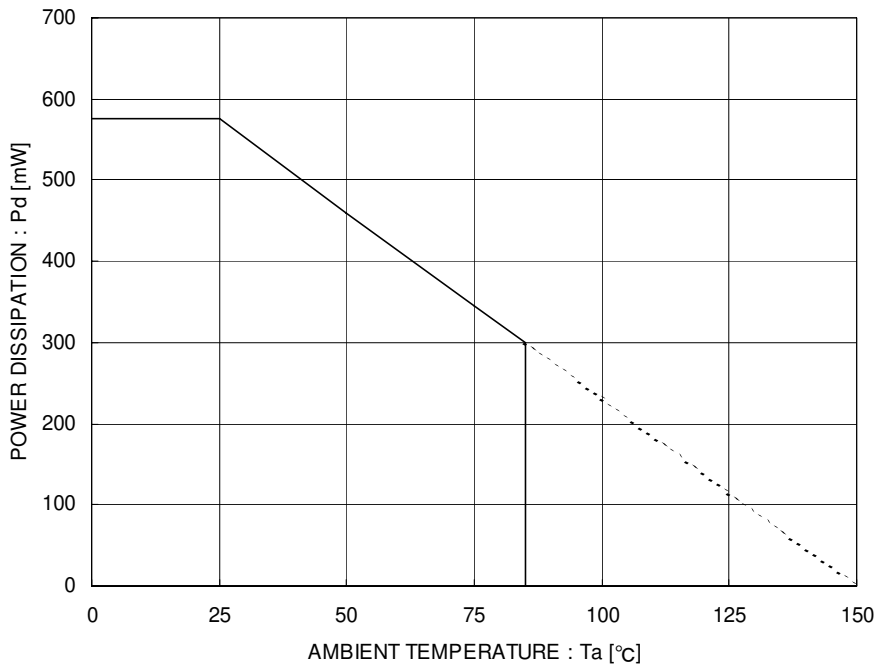

Figure 36. Power dissipation curve (Pd-Ta Curve) (VCSP50L1 package)

● I/O Equivalent Circuit

Pin name	Pin number	Equivalent circuit
EN	6 (A2)	
VIN VOUT	4 (B1) 2, 3 (B2, B3)	

●Operational Notes

- (1) Absolute Maximum Ratings
Operating the IC over the absolute maximum ratings may damage the IC. The damage can either be a short circuit between pins or an open circuit between pins. Therefore, it is important to consider circuit protection measures, such as adding a fuse, in case the IC is operated over the absolute maximum ratings
- (2) Power supply line
Design the PCB layout pattern to provide low impedance ground and supply lines. Separate the ground and supply lines of the digital and analog blocks to prevent noise in the ground and supply lines of the digital block from affecting the analog block. Furthermore, connect a capacitor to ground at all power supply pins. Consider the effect of temperature and aging on the capacitance value when using electrolytic capacitors.
- (3) Ground Voltage
The voltage of the ground pin must be the lowest voltage of all pins of the IC at all operating conditions. Ensure that no pins are at a voltage below the ground pin at any time, even during transient condition.
- (4) Short between pins and mounting errors
Be careful when mounting the IC on printed circuit boards. The IC may be damaged if it is mounted in a wrong orientation or if pins are shorted together. Short circuit may be caused by conductive particles caught between the pins.
- (5) Operation under strong electromagnetic field
Operating the IC in the presence of a strong electromagnetic field may cause the IC to malfunction.
- (6) Regarding input pins of the IC
This monolithic IC contains P+ isolation and P substrate layers between adjacent elements in order to keep them isolated. P-N junctions are formed at the intersection of the P layers with the N layers of other elements, creating a parasitic diode or transistor. For example (refer to figure below):

When GND > Pin A and GND > Pin B, the P-N junction operates as a parasitic diode.

When GND > Pin B, the P-N junction operates as a parasitic transistor.

Parasitic diodes inevitably occur in the structure of the IC. The operation of parasitic diodes can result in mutual interference among circuits, operational faults, or physical damage. Therefore, conditions that cause these diodes to operate, such as applying a voltage lower than the GND voltage to an input pin (and thus to the P substrate) should be avoided.

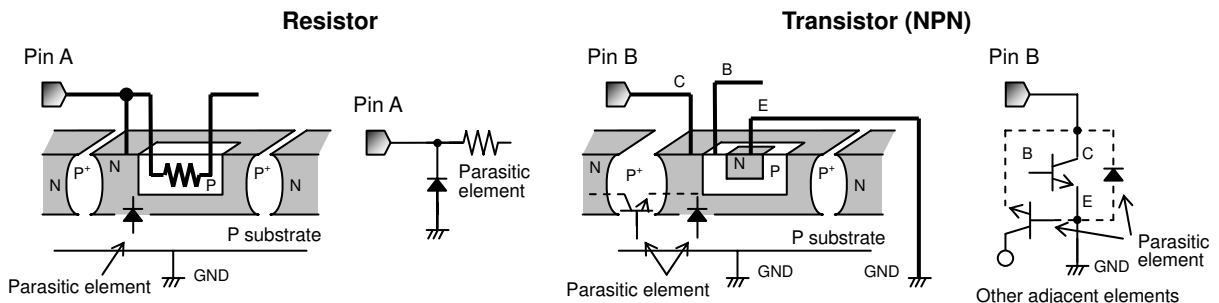

Example of monolithic IC structure

- (7) External Capacitor
When using a ceramic capacitor, determine the dielectric constant considering the change of capacitance with temperature and the decrease in nominal capacitance due to DC bias and others.
- (8) Thermal consideration
Use a thermal design that allows for a sufficient margin by taking into account the permissible power dissipation (Pd) in actual operating conditions. Consider Pc that does not exceed Pd in actual operating conditions (Pc ≥ Pd).

Package Power dissipation : Pd (W) = (Tjmax - Ta) / θja
 Power dissipation : Pc (W) = (Vcc - Vo) × Io + Vcc × Ib

(Tjmax : Maximum junction temperature = 150°C, Ta : Peripheral temperature [°C],
 θja : Thermal resistance of package-ambience [°C/W], Pd : Package Power dissipation [W],
 Pc : Power dissipation [W], Vcc : Input Voltage, Vo : Output Voltage, Io : Load, Ib : Bias Current)

●Ordering Information

B D 6 5 2 8 H F V	- TR
Part Number	Package HFV: HVSO6
	Packaging and forming specification TR: Embossed tape and reel (HVSO6)
B D 6 5 2 9 G U L	- E2
Part Number	Package GUL: VCSP50L1
	Packaging and forming specification E2: Embossed tape and reel (VCSP50L1)

●Marking Diagrams

HVSO6(TOP VIEW)

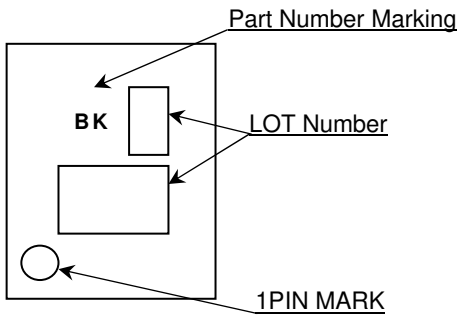

VCSP50L1 (TOP VIEW)

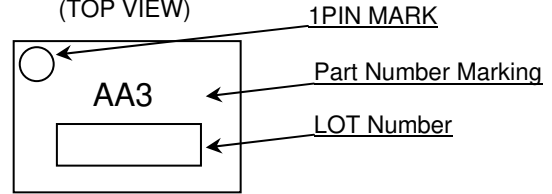

Part Number	Part Number Marking
BD6528HFV	BK
BD6529GUL	AA3

●Physical Dimension, Tape and Reel Information

Package Name	HVSOF6
--------------	--------

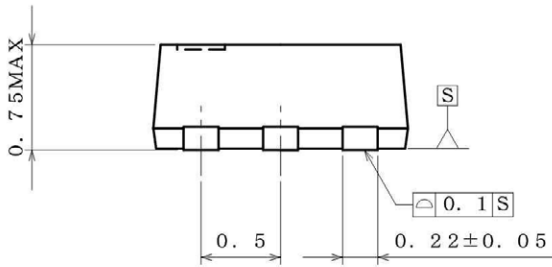
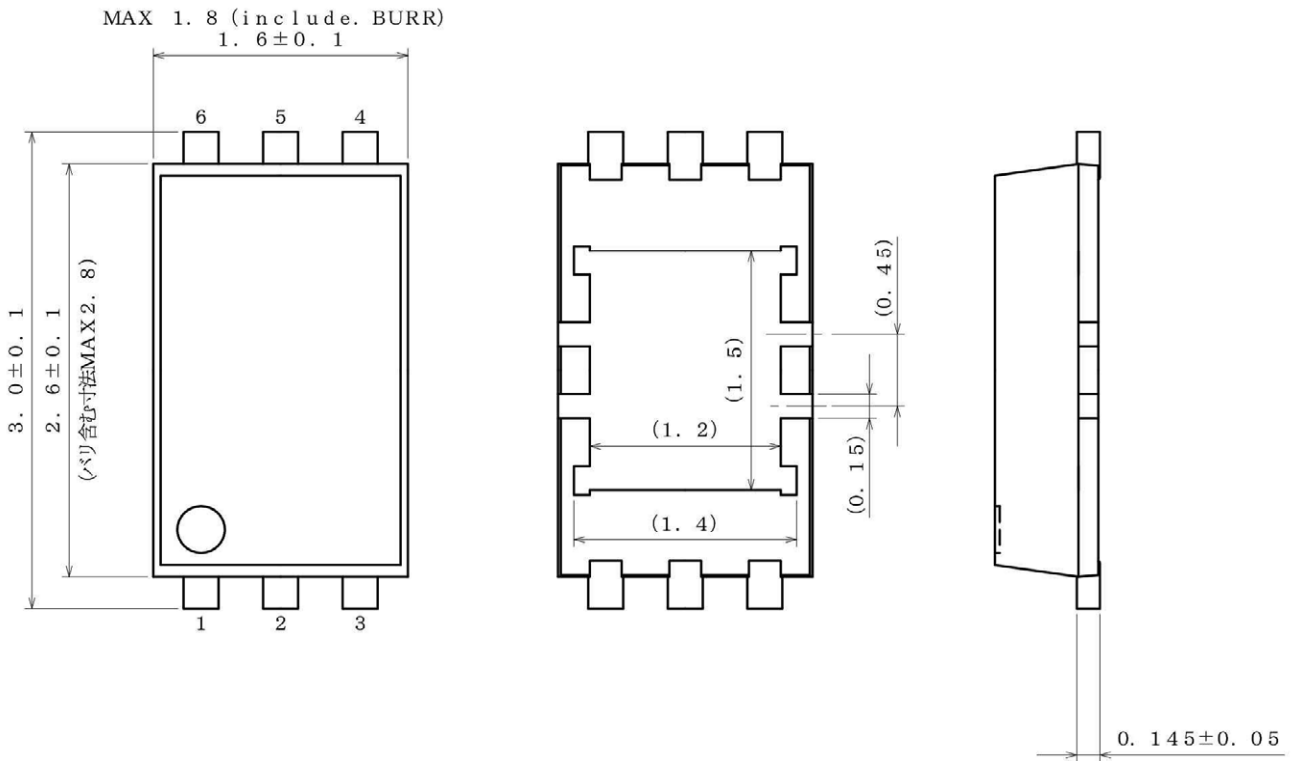

(UNIT : mm)
PKG : HVSOF6
Drawing No. EX162-5002

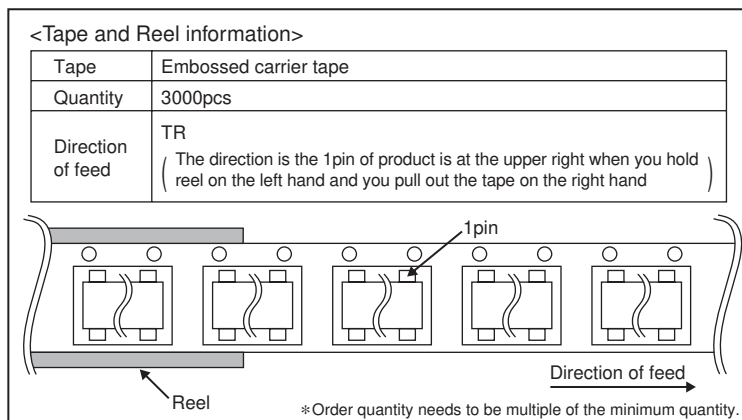

●Revision History

Date	Revision	Changes
11.Mar.2013	001	New Release

Notice

●General Precaution

- 1) Before you use our Products, you are requested to carefully read this document and fully understand its contents. ROHM shall not be in any way responsible or liable for failure, malfunction or accident arising from the use of any ROHM's Products against warning, caution or note contained in this document.
- 2) All information contained in this document is current as of the issuing date and subject to change without any prior notice. Before purchasing or using ROHM's Products, please confirm the latest information with a ROHM sales representative.

●Precaution on using ROHM Products

- 1) Our Products are designed and manufactured for application in ordinary electronic equipments (such as AV equipment, OA equipment, telecommunication equipment, home electronic appliances, amusement equipment, etc.). If you intend to use our Products in devices requiring extremely high reliability (such as medical equipment, transport equipment, traffic equipment, aircraft/spacecraft, nuclear power controllers, fuel controllers, car equipment including car accessories, safety devices, etc.) and whose malfunction or failure may cause loss of human life, bodily injury or serious damage to property ("Specific Applications"), please consult with the ROHM sales representative in advance. Unless otherwise agreed in writing by ROHM in advance, ROHM shall not be in any way responsible or liable for any damages, expenses or losses incurred by you or third parties arising from the use of any ROHM's Products for Specific Applications.
- 2) ROHM designs and manufactures its Products subject to strict quality control system. However, semiconductor products can fail or malfunction at a certain rate. Please be sure to implement, at your own responsibilities, adequate safety measures including but not limited to fail-safe design against the physical injury, damage to any property, which a failure or malfunction of our Products may cause. The following are examples of safety measures:
 - [a] Installation of protection circuits or other protective devices to improve system safety
 - [b] Installation of redundant circuits to reduce the impact of single or multiple circuit failure
- 3) Our Products are designed and manufactured for use under standard conditions and not under any special or extraordinary environments or conditions, as exemplified below. Accordingly, ROHM shall not be in any way responsible or liable for any damages, expenses or losses arising from the use of any ROHM's Products under any special or extraordinary environments or conditions. If you intend to use our Products under any special or extraordinary environments or conditions (as exemplified below), your independent verification and confirmation of product performance, reliability, etc. prior to use, must be necessary:
 - [a] Use of our Products in any types of liquid, including water, oils, chemicals, and organic solvents
 - [b] Use of our Products outdoors or in places where the Products are exposed to direct sunlight or dust
 - [c] Use of our Products in places where the Products are exposed to sea wind or corrosive gases, including Cl₂, H₂S, NH₃, SO₂, and NO₂
 - [d] Use of our Products in places where the Products are exposed to static electricity or electromagnetic waves
 - [e] Use of our Products in proximity to heat-producing components, plastic cords, or other flammable items
 - [f] Sealing or coating our Products with resin or other coating materials
 - [g] Use of our Products without cleaning residue of flux (even if you use no-clean type fluxes, cleaning residue of flux is recommended); or Washing our Products by using water or water-soluble cleaning agents for cleaning residue after soldering
 - [h] Use of the Products in places subject to dew condensation
- 4) The Products are not subject to radiation-proof design.
- 5) Please verify and confirm characteristics of the final or mounted products in using the Products.
- 6) In particular, if a transient load (a large amount of load applied in a short period of time, such as pulse) is applied, confirmation of performance characteristics after on-board mounting is strongly recommended. Avoid applying power exceeding normal rated power; exceeding the power rating under steady-state loading condition may negatively affect product performance and reliability.
- 7) De-rate Power Dissipation (Pd) depending on Ambient temperature (Ta). When used in sealed area, confirm the actual ambient temperature.
- 8) Confirm that operation temperature is within the specified range described in the product specification.
- 9) ROHM shall not be in any way responsible or liable for failure induced under deviant condition from what is defined in this document.

●Precaution for Mounting / Circuit board design

- 1) When a highly active halogenous (chlorine, bromine, etc.) flux is used, the residue of flux may negatively affect product performance and reliability.
- 2) In principle, the reflow soldering method must be used; if flow soldering method is preferred, please consult with the ROHM representative in advance.

For details, please refer to ROHM Mounting specification

●Precautions Regarding Application Examples and External Circuits

- 1) If change is made to the constant of an external circuit, please allow a sufficient margin considering variations of the characteristics of the Products and external components, including transient characteristics, as well as static characteristics.
- 2) You agree that application notes, reference designs, and associated data and information contained in this document are presented only as guidance for Products use. Therefore, in case you use such information, you are solely responsible for it and you must exercise your own independent verification and judgment in the use of such information contained in this document. ROHM shall not be in any way responsible or liable for any damages, expenses or losses incurred by you or third parties arising from the use of such information.

●Precaution for Electrostatic

This Product is electrostatic sensitive product, which may be damaged due to electrostatic discharge. Please take proper caution in your manufacturing process and storage so that voltage exceeding the Products maximum rating will not be applied to Products. Please take special care under dry condition (e.g. Grounding of human body / equipment / solder iron, isolation from charged objects, setting of Ionizer, friction prevention and temperature / humidity control).

●Precaution for Storage / Transportation

- 1) Product performance and soldered connections may deteriorate if the Products are stored in the places where:
 - [a] the Products are exposed to sea winds or corrosive gases, including Cl₂, H₂S, NH₃, SO₂, and NO₂
 - [b] the temperature or humidity exceeds those recommended by ROHM
 - [c] the Products are exposed to direct sunshine or condensation
 - [d] the Products are exposed to high Electrostatic
- 2) Even under ROHM recommended storage condition, solderability of products out of recommended storage time period may be degraded. It is strongly recommended to confirm solderability before using Products of which storage time is exceeding the recommended storage time period.
- 3) Store / transport cartons in the correct direction, which is indicated on a carton with a symbol. Otherwise bent leads may occur due to excessive stress applied when dropping of a carton.
- 4) Use Products within the specified time after opening a humidity barrier bag. Baking is required before using Products of which storage time is exceeding the recommended storage time period.

●Precaution for Product Label

QR code printed on ROHM Products label is for ROHM's internal use only.

●Precaution for Disposition

When disposing Products please dispose them properly using an authorized industry waste company.

●Precaution for Foreign Exchange and Foreign Trade act

Since our Products might fall under controlled goods prescribed by the applicable foreign exchange and foreign trade act, please consult with ROHM representative in case of export.

●Precaution Regarding Intellectual Property Rights

- 1) All information and data including but not limited to application example contained in this document is for reference only. ROHM does not warrant that foregoing information or data will not infringe any intellectual property rights or any other rights of any third party regarding such information or data. ROHM shall not be in any way responsible or liable for infringement of any intellectual property rights or other damages arising from use of such information or data.:
- 2) No license, expressly or implied, is granted hereby under any intellectual property rights or other rights of ROHM or any third parties with respect to the information contained in this document.

●Other Precaution

- 1) The information contained in this document is provided on an "as is" basis and ROHM does not warrant that all information contained in this document is accurate and/or error-free. ROHM shall not be in any way responsible or liable for any damages, expenses or losses incurred by you or third parties resulting from inaccuracy or errors of or concerning such information.
- 2) This document may not be reprinted or reproduced, in whole or in part, without prior written consent of ROHM.
- 3) The Products may not be disassembled, converted, modified, reproduced or otherwise changed without prior written consent of ROHM.
- 4) In no event shall you use in any way whatsoever the Products and the related technical information contained in the Products or this document for any military purposes, including but not limited to, the development of mass-destruction weapons.
- 5) The proper names of companies or products described in this document are trademarks or registered trademarks of ROHM, its affiliated companies or third parties.