



Chipsmall Limited consists of a professional team with an average of over 10 year of expertise in the distribution of electronic components. Based in Hongkong, we have already established firm and mutual-benefit business relationships with customers from,Europe,America and south Asia,supplying obsolete and hard-to-find components to meet their specific needs.

With the principle of “Quality Parts,Customers Priority,Honest Operation,and Considerate Service”,our business mainly focus on the distribution of electronic components. Line cards we deal with include Microchip,ALPS,ROHM,Xilinx,Pulse,ON,Everlight and Freescale. Main products comprise IC,Modules,Potentiometer,IC Socket,Relay,Connector.Our parts cover such applications as commercial,industrial, and automotives areas.

We are looking forward to setting up business relationship with you and hope to provide you with the best service and solution. Let us make a better world for our industry!



Contact us

Tel: +86-755-8981 8866 Fax: +86-755-8427 6832

Email & Skype: info@chipsmall.com Web: www.chipsmall.com

Address: A1208, Overseas Decoration Building, #122 Zhenhua RD., Futian, Shenzhen, China



Single-chip Type with Built-in FET Switching Regulators

Output 1.5A or Less

High-efficiency Step-down Switching Regulator with Built-in Power MOSFET



BD8313HFN

No.11027EET05

●Description

BD8313HFN produces step-down output including 1.2, 1.8, 3.3, or 5 V from 4 batteries, batteries such as Li2cell or Li3cell, etc. or a 5V/12V fixed power supply line.

BD8313HFN allows easy production of small power supply by a wide range of external constants, and is equipped with an external coil/capacitor downsized by high frequency operation of 1.0 MHz, built-in synchronous rectification SW capable of withstanding 15 V, and flexible phase compensation system on board.

●Features

- 1) Incorporates Pch/Nch synchronous rectification SW capable of withstanding 1.2 A/15V.
- 2) Incorporates phase compensation device between input and output of Error AMP.
- 3) Small coils and capacitors to be used by high frequency operation of 1.0MHz
- 4) Input voltage 3.5 V – 14 V
Output current 1.2A(7.4V input, 3.3V output)
0.8A(4.5V input, 3.3V output)
- 5) Incorporates soft-start function.
- 6) Incorporates timer latch system short protecting function.
- 7) As small as 2.9mm×3 mm, SON 8-pin package HSON8

●Application

For portable equipment like DSC/DVC powered by 4 dry batteries or Li2cell and Li3cell, or general consumer-equipment with 5 V/12 V lines

●Operating Conditions (Ta = 25°C)

Parameter	Symbol	Ratings	Unit
Power supply voltage	VCC	3.5 - 14	V
Output voltage	VOU	1.2 - 12	V

●Absolute Maximum Ratings

Parameter	Symbol	Ratings	Unit
Maximum applied power voltage	VCC, PVCC	15	V
Maximum input current	linmax	1.2	A
Power dissipation	Pd	630	mW
Operating temperature range	Topr	-40 ~ +85	°C
Storage temperature range	Tstg	-55 ~ +150	°C
Junction temperature	Tjmax	+150	°C

*1 When used at Ta = 25°C or more installed on a 70×70×1.6mm board, the rating is reduced by 5.04mW/°C.

* These specifications are subject to change without advance notice for modifications and other reasons.

●Electrical Characteristics

(Unless otherwise specified, Ta = 25 °C, VCC = 7.4 V)

Parameter	Symbol	Limits			Unit	Conditions	
		Min	Typ	Max			
[Low voltage input malfunction preventing circuit]							
Detection threshold voltage	VUV	-	2.9	3.2	V	VREG monitor	
Hysteresis range	ΔV_{UVhy}	100	200	300	mV		
[Oscillator]							
Oscillation frequency	Fosc	0.9	1.0	1.1	MHz		
[Regulator]							
Output voltage	VREG	4.65	5.0	5.35	V		
[Error AMP]							
INV threshold voltage	VINV	0.99	1.00	1.01	V		
Input bias current	IINV	-50	0	50	nA	VCC = 12.0 V , VINV = 6.0 V	
Soft-start time	Tss	4.8	8.0	11.1	msec		
[PWM comparator]							
LX Max Duty	Dmax	-	-	100 ^(※)	%		
[Output]							
PMOS ON resistance	R _{ONP}	-	450	600	mΩ		
NMOS ON resistance	R _{ONN}	-	300	420	mΩ		
Leak current	I _{leak}	-1	0	1	μA		
[STB]							
STB pin control voltage	Operation	V _{STBH}	2.5	-	14	V	
	No-operation	V _{STBL}	-0.3	-	0.3	V	
STB pin pull-down resistance	R _{STB}	250	400	700	kΩ		
[Circuit current]							
Standby current	VCC pin	I _{STB1}	-	-	1	μA	
	PVCC pin	I _{STB2}	-	-	1	μA	
Circuit current at operation VCC	I _{CC1}	-	600	900	μA	VINV = 1.2 V	
Circuit current at operation PVCC	I _{CC2}	-	30	50	μA	VINV = 1.2 V	

(※1)100% is MAX Duty as behavior of a PWM comparator.

Using in region where High side PMOS is 100% on state when the same or less input voltage than output voltage is supplied as an application circuit causes detection of SCP then DC/DC converter stops.

⊙ Not designed to be resistant to radiation

●Description of Pins

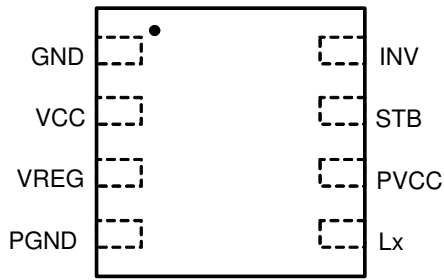

Pin No.	Pin Name	Function
1	GND	Ground terminal
2	VCC	Control part power input terminal
3	VREG	5 V output terminal of regulator for internal circuit
4	PGND	Power transistor ground terminal
5	Lx	Coil connecting terminal
6	PVCC	DC/DC converter input terminal
7	STB	ON/OFF terminal
8	INV	Error AMP input terminal

Fig.1 Terminal layout

●Block Diagram

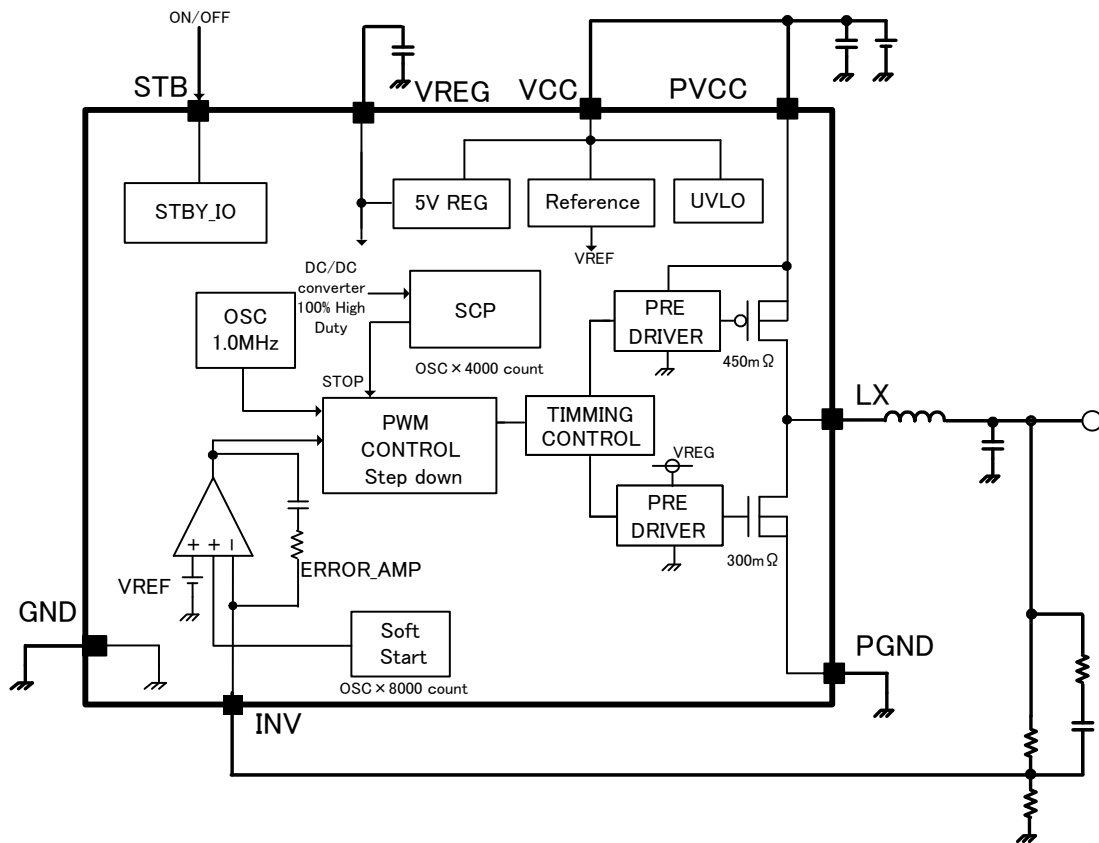

Fig.2 Block diagram

●Description of Blocks

1. Reference
This block produces ERROR AMP standard voltage.
The standard voltage is 1.0 V.
2. 5 V Reg
5 V low saturation regulator for internal analog circuit
BD8313HFN is equipped with this regulator for the purpose of protecting the internal circuit from high voltage. Therefore, this output is reduced when VCC is less than 5 V, then PMOS ON resistance increases and Power efficiency and Maximum output current of DC/DC converter decreases in this region. Please see attached data (fig14,15,16,17) about increasing of PMOS ON resistance in this region.
- 3 UVLO
Circuit for preventing low voltage malfunction
Prevents malfunction of the internal circuit at activation of the power supply voltage or at low power supply voltage.
Monitors VCC pin voltage to turn off all output FET and DC/DC converter output when VCC voltage is lower than 2.9 V, and reset the timer latch of the internal SCP circuit and soft-start circuit. This threshold contains 200 mV hysteresis.
- 4 SCP
Timer latch system short-circuit protection circuit
When DC/DC converter is 100% High Duty, the internal SCP circuit starts counting.
The internal counter is in synch with OSC, the latch circuit is activated about 4 msec after the counter counts about 4000 oscillations to turn off DC/DC converter output.
To reset the latch circuit, turn off the STB pin once. Then, turn it on again or turn on the power supply voltage again.
- 5 OSC
Circuit for oscillating sawtooth waves with an operation frequency fixed at 1.0 MHz
- 6 ERROR AMP
Error amplifier for detecting output signals and output PWM control signals
The internal standard voltage is set at 1.0 V.
A primary phase compensation device of 200 pF, 62 kΩ is built in-between the inverting input terminal and the output terminal of this ERROR AMP.
- 7 PWM COMP
Voltage-pulse width converter for controlling output voltage corresponding to input voltage
Comparing the internal SLOPE waveform with the ERROR AMP output voltage, PWM COMP controls the pulse width to the output to the driver.
- 8 SOFT START
Circuit for preventing in-rush current at startup by bringing the output voltage of the DC/DC converter into a soft-start
Soft-start time is in synch with the internal OSC, and the output voltage of the DC/DC converter reaches the set voltage after about 8000 oscillations.
- 9 PRE DRIVER/TIMING CONTROL
CMOS inverter circuit for driving the built-in synchronous rectification SW
The synchronous rectification OFF time for preventing feedthrough is about 25 nsec.
- 10 STBY_IO
Voltage applied on STB pin (7 pin) to control ON/OFF of IC
Turned ON when a voltage of 2.5 V or higher is applied and turned OFF when the terminal is open or 0 V is applied.
Incorporates approximately 400 kΩ pull-down resistance.
- 11 Pch/Nch FET SW
Built-in synchronous rectification SW for switching the coil current of the DC/DC converter
Incorporates a 450 mΩ PchFET SW capable of withstanding 15 V.and 300 mΩ SW capable of withstanding 15 V.
Since the current rating of this FET is 1.2 A, it should be used within 1.2 A including the DC current and ripple current of the coil.

● Reference data

(Unless otherwise specified, Ta = 25°C, VCC = 7.4 V)

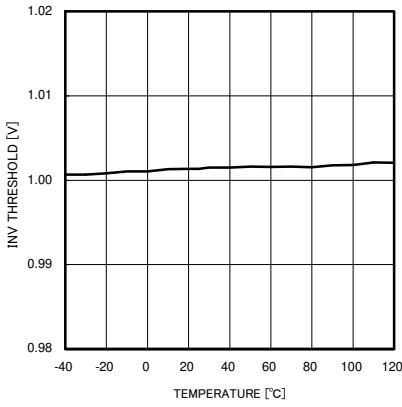

Fig.3. INV threshold temperature property

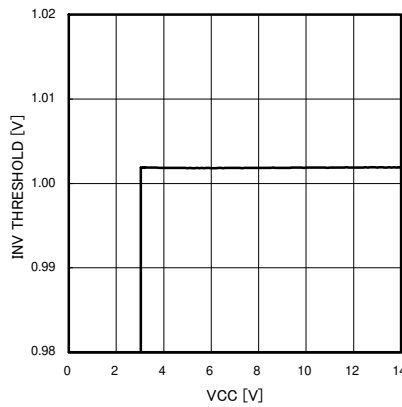

Fig.4. INV threshold power supply property

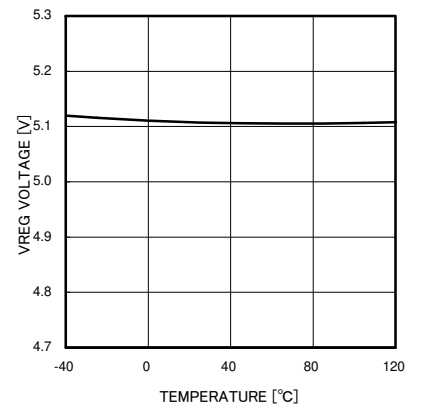

Fig.5. VREG output temperature property

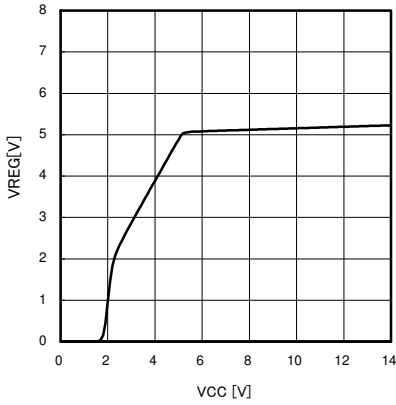

Fig.6. VREG output power supply property

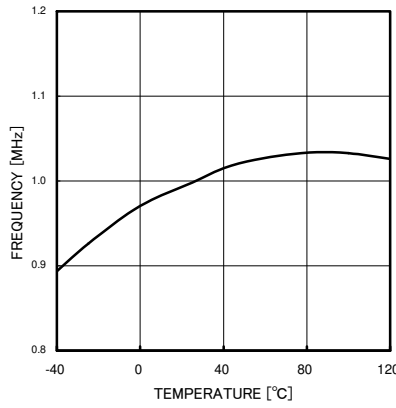

Fig.7. fosc temperature property

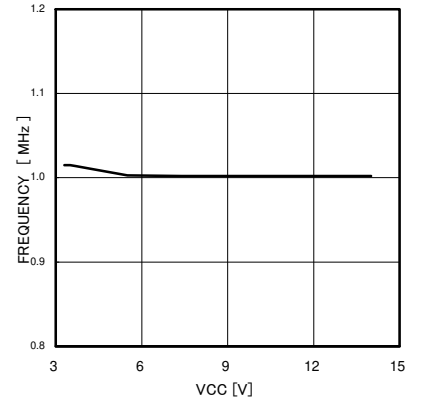

Fig.8. fosc voltage property

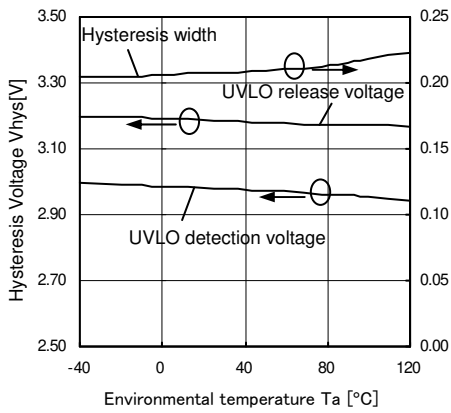

Fig.9. UVLO threshold temperature property

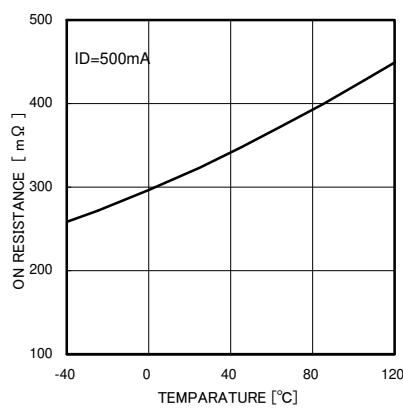

Fig.10. Nch FET ON resistance temperature property

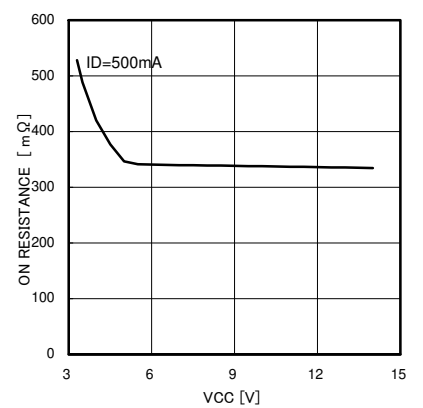

Fig.11. Nch FET ON resistance power supply property

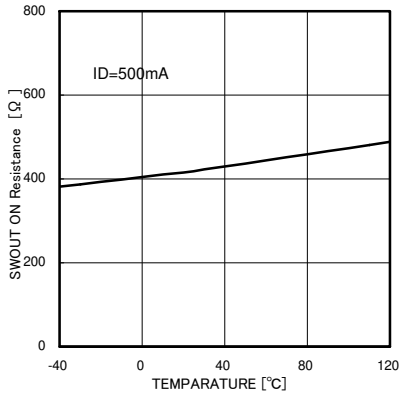

Fig.12. Pch FET ON resistance temperature property

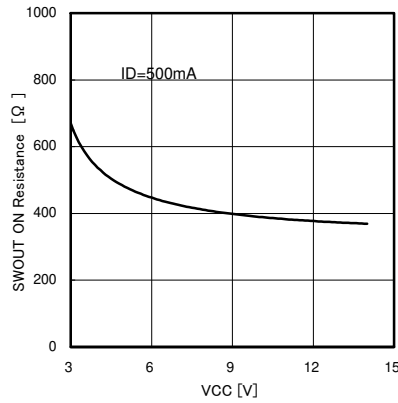

Fig.13. Pch FET ON resistance power supply property

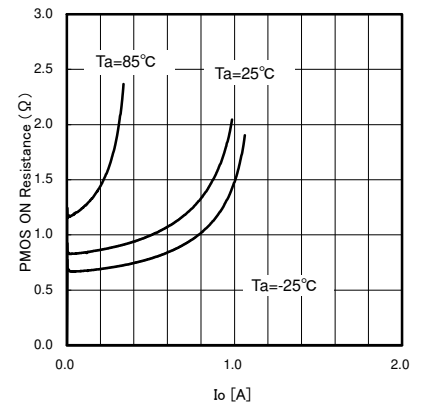

Fig.14. PchFET ON resistance Io property [VCC=3.5V]

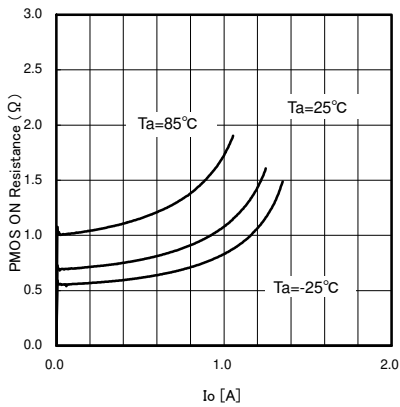

Fig.15. PchFET ON resistance Io property [VCC=4.0V]

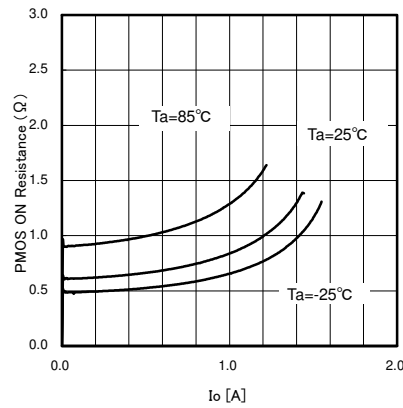

Fig.16. PchFET ON resistance Io property [VCC=4.5V]

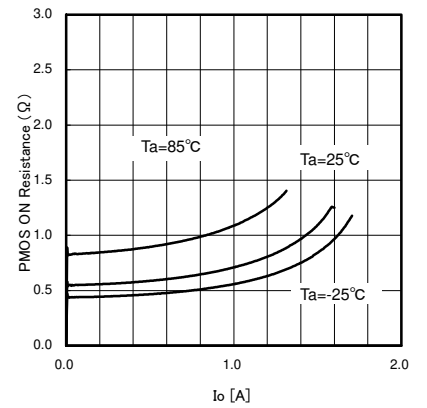

Fig.17. PchFET ON resistance Io property [VCC=5.0V]

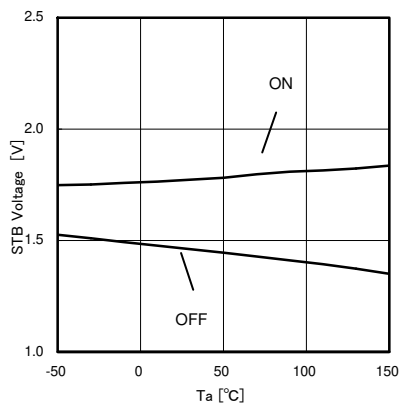

Fig.18. STB threshold temperature property

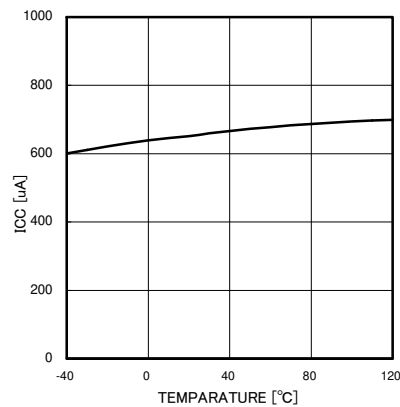

Fig.19. Circuit current temperature property

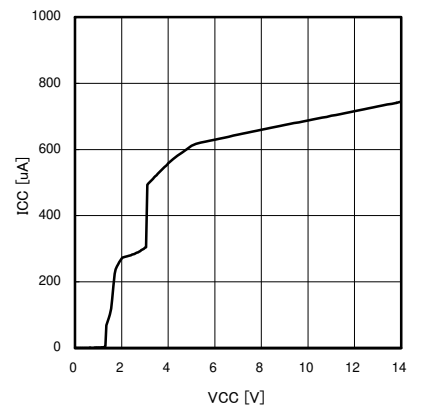

Fig.20. Circuit current voltage property

●Example of Application1 Input: 4.5 to 10 V, output: 3.3 V / 500mA

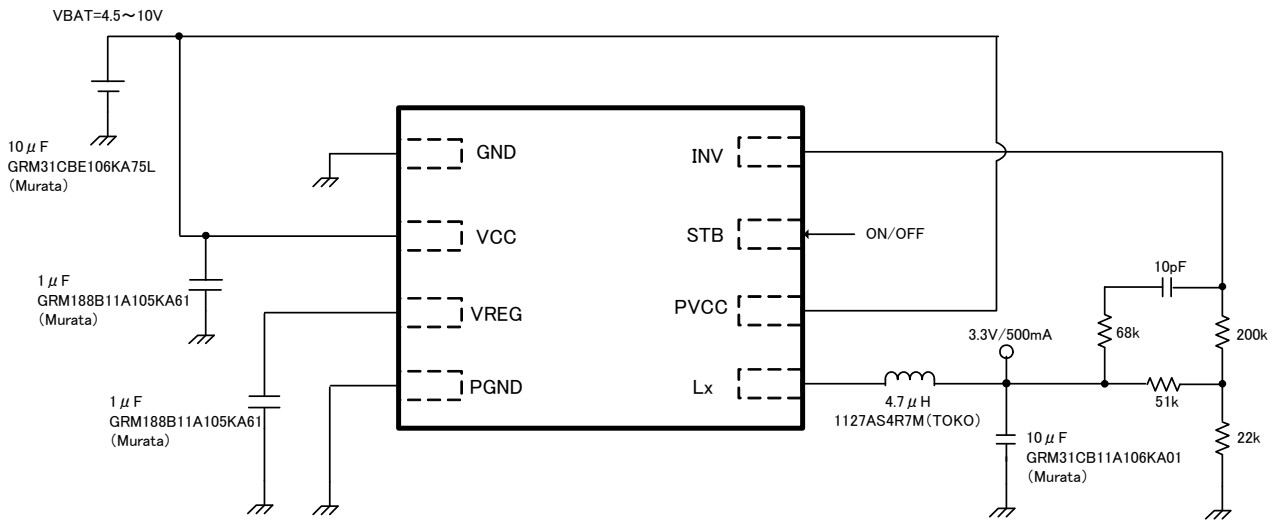

Fig.21 Reference application diagram1

●Reference application data 1 (Example of application1)

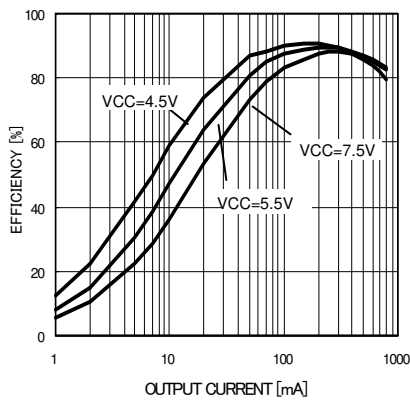

Fig.22 Power conversion efficiency (VOUT = 3.3 V)

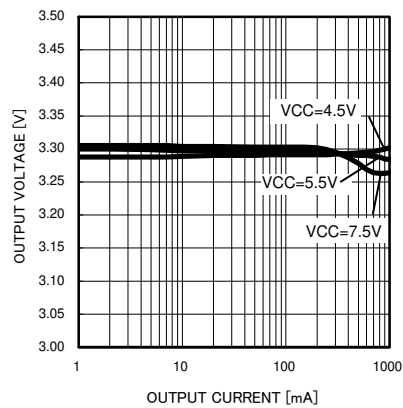

Fig.23 Load regulation (VOUT = 3.3 V)

● Reference application data 2 (Input 4.5 V, 6.0 V, 8.4 V, 10 V, output 3.3 V) (Example of application1)

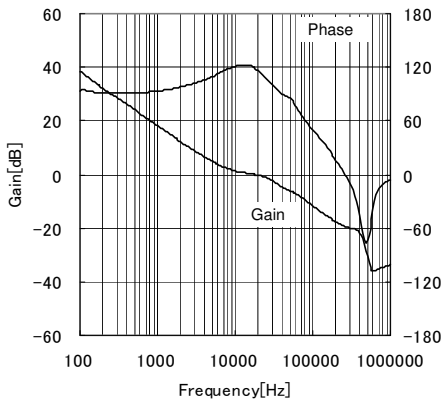

Fig.24 Frequency response 1
(VCC=4.5V, Io=250mA)

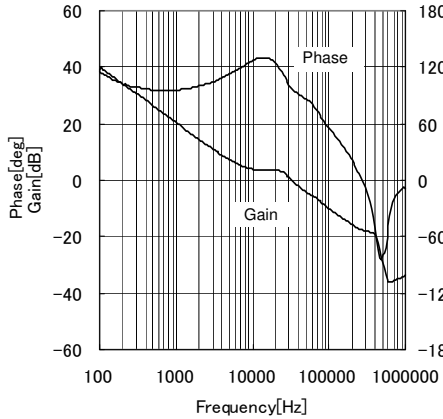

Fig.25 Frequency response 2
(VCC=6.0V, Io=250mA)

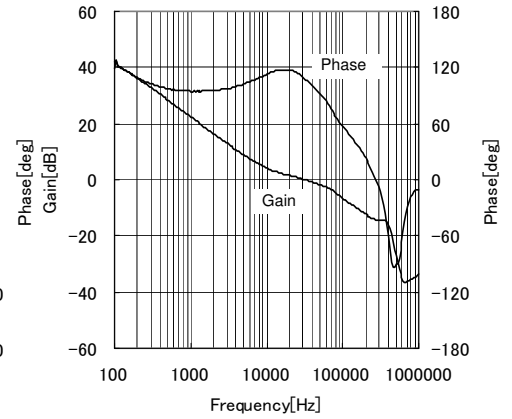

Fig.26 Frequency response 3
(VCC=8.4V, Io=250mA)

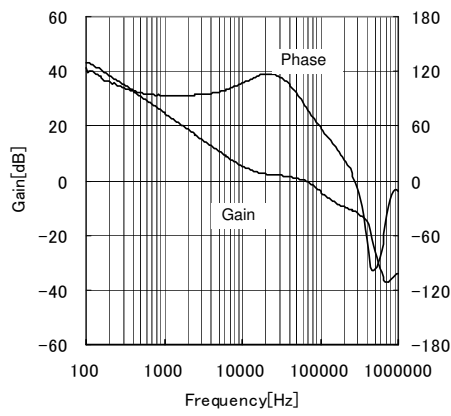

Fig.27 Frequency response 4
(VCC=10V, Io=250mA)

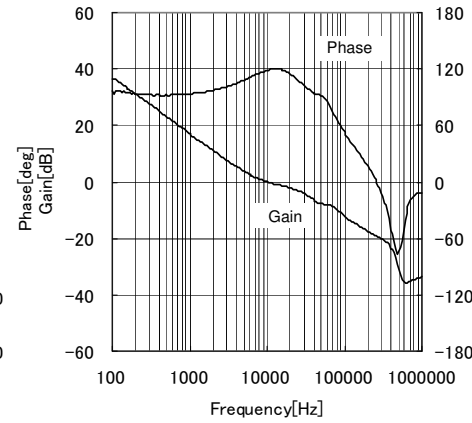

Fig.28 Frequency response 5
(VCC=4.5V, Io=500mA)

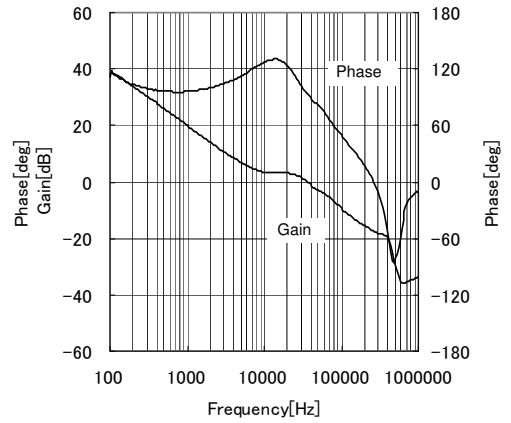

Fig.29 Frequency response 6
(VCC=6.0V, Io=500mA)

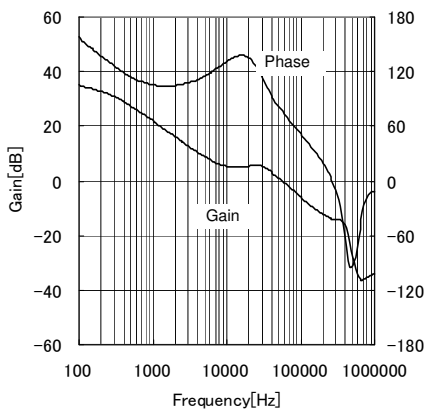

Fig.30 Frequency response 7
(VCC=8.4V, Io=500mA)

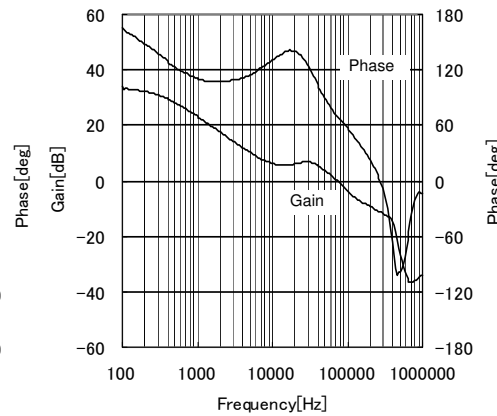

Fig.31 Frequency response 8
(VCC=10V, Io=500mA)

●Example of application2 input4.5 to 12V, output1.2V / 500mA

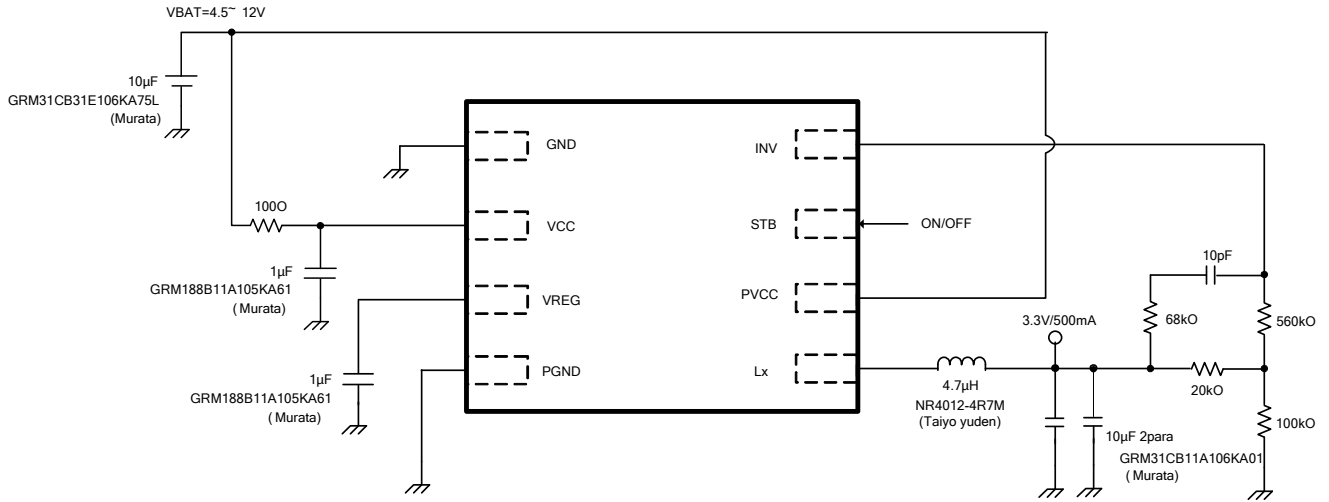

Fig.32 Reference application diagram2

●Reference application data 1 (Example of application2)

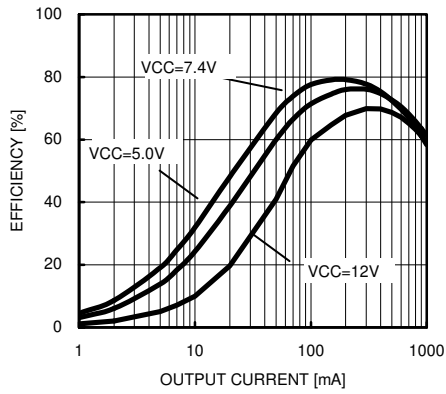

Fig.33 Power conversion efficiency (VOUT = 1.2 V)

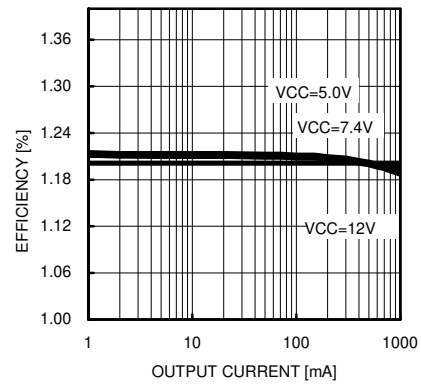

Fig.34 Load regulation (VOUT = 1.2 V)

●Reference application data 2(input5.0V, 7.4V, 10V output1.2V)Example of application(2)

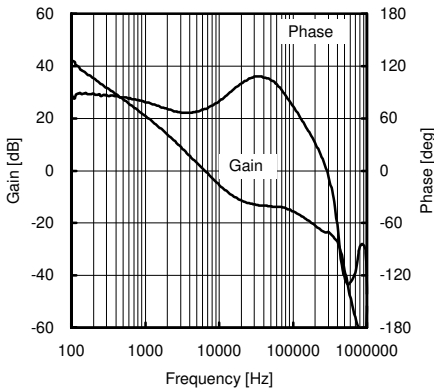

Fig.35 Frequency response 1
(VCC=5.0V, Io=100mA)

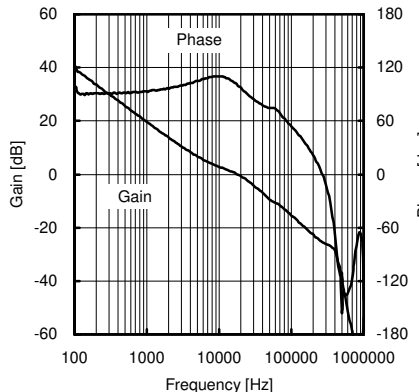

Fig.36 Frequency response 2
(VCC=5.0V, Io=300mA)

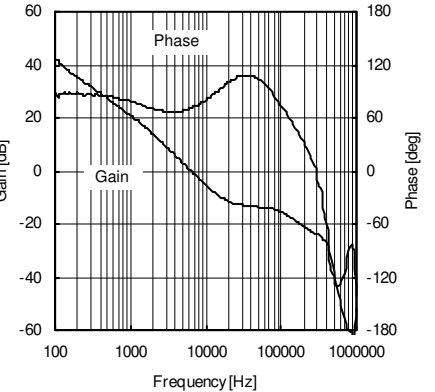

Fig.37 Frequency response 3
(VCC=5.0V, Io=900mA)

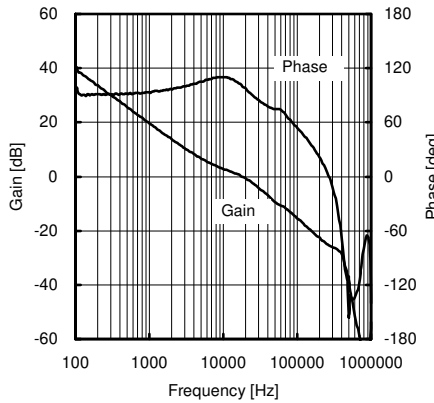

Fig.38 Frequency response 4
(VCC=7.4V, Io=100mA)

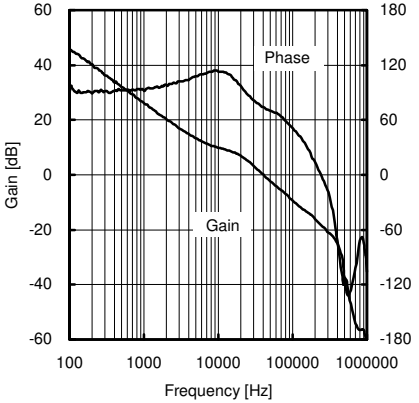

Fig.39 Frequency response 5
(VCC=7.4V, Io=300mA)

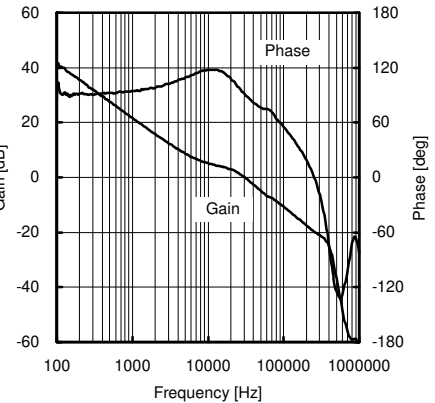

Fig.40 Frequency response 6
(VCC=7.4V, Io=900mA)

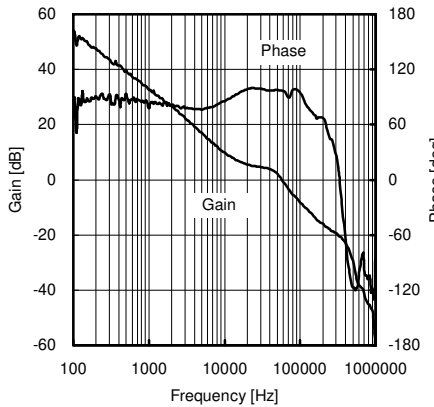

Fig.41 Frequency response 7
(VCC=10V, Io=100mA)

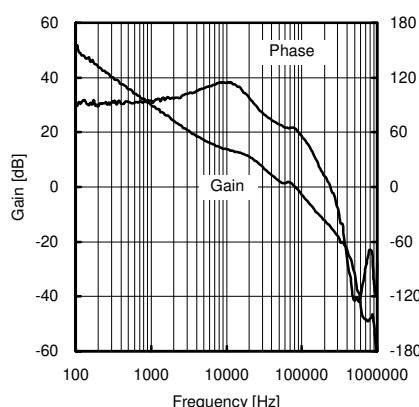

Fig.42 Frequency response 8
(VCC=10V, Io=300mA)

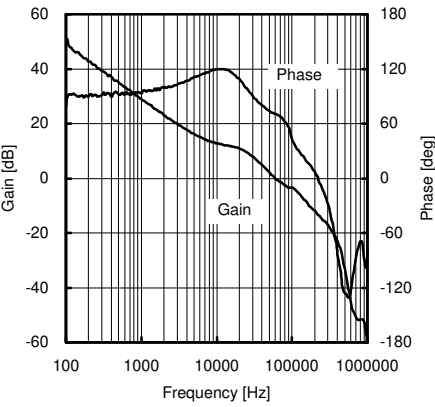

Fig.43 Frequency response 9
(VCC=10V, Io=900mA)

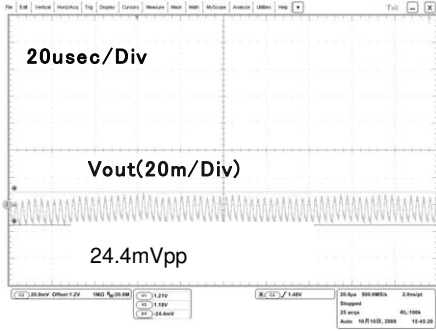

Fig.44 Output ripple 1 (VCC=12V, Io=40mA)

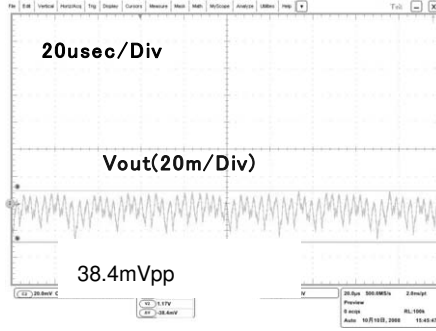

Fig.45 Output ripple 2 (VCC=12V, Io=100mA)

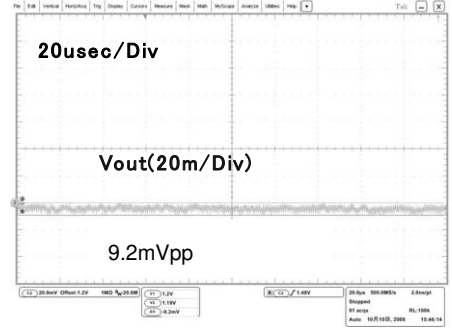

Fig.46 Output ripple 3 (VCC=12V, Io=140mA)

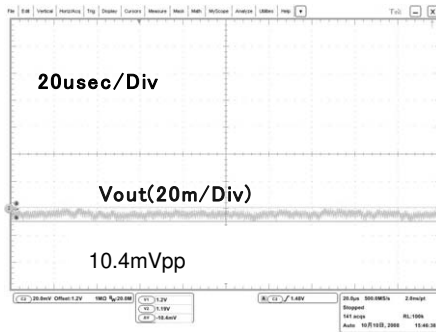

Fig.47 Output ripple 4 (VCC=12V, Io=170mA)

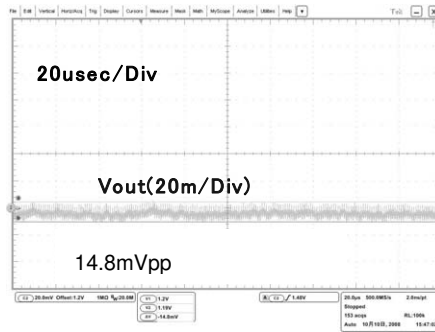

Fig.48 Output ripple 5 (VCC=12V, Io=900mA)

●Output ripple voltage

BD8313HFN is controlled by PWM(Pulse Width Modulation)mode.

PWM output made by comparison SLOPE with FB(error amp output) controls switching of IC under the PWM mode.

When FB level is completely lower than SLOPE level, DC/DC converter switches as non- synchronous step-down switching mode not to make output voltage level drop quickly caused by full ON state of Low side Nch FET.

Ripple voltage of output voltage in non-synchronous mode is larger than that in synchronous mode.

When voltage difference between input and output voltage is large and output current is small, DCDC converter switches as this non-synchronous mode then ripple voltage of output voltage could be large.

In the reference data above (output ripple 1 to 4), ripple voltage at 12V input 1.2V output , output current is smaller than 100mA is larger than other region.

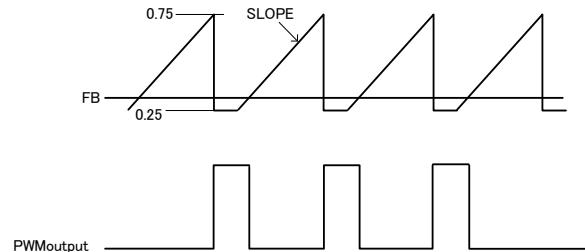

●Reference board pattern

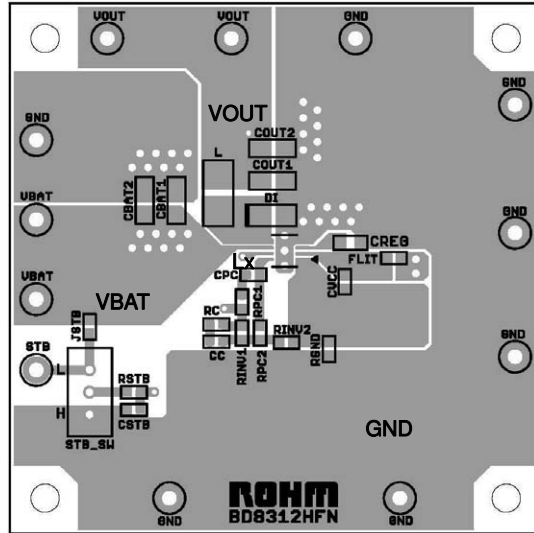

The radiation plate on the rear should be a GND flat surface of low impedance in common with the PGND flat surface. It is recommended to install a GND pin in another system as shown in the drawing without connecting it directly to this PNGD. Produce as wide a pattern as possible for the VBAT, Lx and PGND lines in which large current flows.

●Selection of Part for Applications

(1) Inductor

A shielded inductor that satisfies the current rating (current value, I_{peak} as shown in the drawing below) and has a low DCR (direct resistance component) is recommended. Inductor values affect inductor ripple current, which will cause output ripple. Ripple current can be reduced as the coil L value becomes larger and the switching frequency becomes higher.

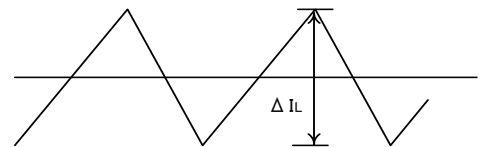

Fig.49 Inductor current

$$I_{peak} = I_{out} + \Delta I_L / 2 \text{ [A]} \quad \dots (1)$$

$$\Delta I_L = \frac{V_{in} - V_{out}}{L} \times \frac{V_{out}}{V_{in}} \times \frac{1}{f} \text{ [A]} \quad \dots (2)$$

(η: Efficiency, ΔIL: Output ripple current, f: Switching frequency)

As a guide, inductor ripple current should be set at about 20 to 50% of the maximum input current.

*Current over the coil rating flowing in the coil brings the coil into magnetic saturation, which may lead to lower efficiency or output oscillation. Select an inductor with an adequate margin so that the peak current does not exceed the rated current of the coil.

(2) Output capacitor

A ceramic capacitor with low ESR is recommended for output in order to reduce output ripple. There must be an adequate margin between the maximum rating and output voltage of the capacitor, taking the DC bias property into consideration.

Output ripple voltage is acquired by the following equation.

$$V_{pp} = \Delta I_L \times \frac{1}{2\pi \times f \times C_o} + \Delta I_L \times R_{ESR} \text{ [V]} \quad \dots (3)$$

Setting must be performed so that output ripple is within the allowable ripple voltage.

(3) Output voltage setting

The internal standard voltage of the ERROR AMP is 1.0 V. Output voltage is acquired by Equation (4).

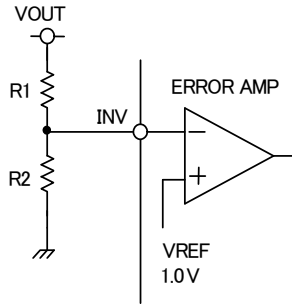

$$V_o = \frac{(R_1 + R_2)}{R_2} \times 1.0 \text{ [V]} \dots (4)$$

Fig.50 Setting of voltage feedback resistance

(4) DC/DC converter frequency response adjustment system

Condition for stable application

The condition for feedback system stability under negative feedback is that the phase delay is 135° or less when gain is 1 (0dB).

Since DC/DC converter application is sampled according to the switching frequency, the bandwidth GBW of the whole system (frequency at which gain is 0 dB) must be controlled to be equal to or lower than 1/10 of the switching frequency. In summary, the conditions necessary for the DC/DC converter are:

- Phase delay must be 135° or lower when gain is 1 (0 dB).
- Bandwidth GBW (frequency when gain is 0 dB) must be equal to or lower than 1/10 of the switching frequency.

To satisfy those two points, R₁, R₂, R₃, D_s and R_s in Fig. 51 should be set as follows.

[1] R₁, R₂, R₃

BD8313HFN incorporates phase compensation devices of R₄=62kΩ and C₂=200pF. These C₂ and R₁, R₂, and R₃ values decide the primary pole that determines the bandwidth of DC/DC converter.

Primary pole point frequency

$$f_p = \frac{1}{2\pi \left\{ A \times \left(\frac{R_1 \times R_2}{R_1 + R_2} + R_3 \right) \times C_2 \right\}} \dots (1)$$

DC/DC converter DC Gain

$$\text{DC Gain} = A \times \frac{1}{B} \times \frac{V_{IN}}{V_O} \dots (2)$$

By Equations (1) and (2), the frequency f_{sw} of point 0 dB under limitation of the bandwidth of the DC gain at the primary pole point is as shown below.

$$f_{sw} = f_p \times \text{DC Gain} = \frac{1}{2\pi C_2 \times \left(\frac{R_1 \cdot R_2}{R_1 + R_2} + R_3 \right)} \times \frac{1}{B} \times \frac{V_{IN}}{V_O} \dots (3)$$

It is recommended that f_{sw} should be approx. 10 kHz. When load response is difficult, it may be set at approx. 20 kHz. By Equation (3), R₁ and R₂, which determine the voltage value, will be in the order of several hundred kΩ. If an appropriate resistance value is not available since the resistance is so high and routing may cause noise, the use of R₃ enables easy setting.

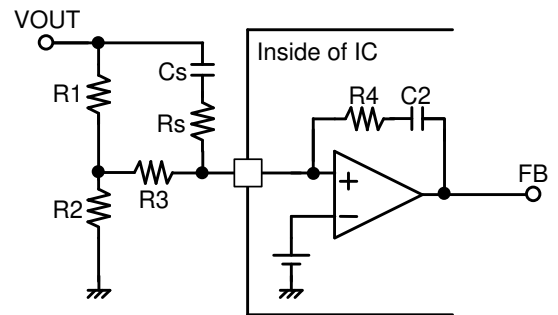

Fig.51 Example of phase compensation setting

- A: Error AMP Gain
About 100dB = 10⁵
- B: Oscillator amplification = 0.5
- V_{IN}: Input voltage
- V_{OUT}: Output voltage

[2] Cs and Rs setting

For DC/DC converter, the 2nd dimension pole point is caused by the coil and capacitor as expressed by the following equation.

$$f_{LC} = \frac{1}{2\pi\sqrt{LC}} \quad \dots \dots (4)$$

This secondary pole causes a phase rotation of 180°. To secure the stability of the system, put a zero point in 2 places to perform compensation.

Zero point by built-in CR $f_{z1} = \frac{1}{2\pi R_4 C_2} = 13\text{kHz} \quad \dots \dots (5)$

Zero point by Cs $f_{z1} = \frac{1}{2\pi(R_1+R_3)C_s} \quad \dots \dots (6)$

Setting f_{z2} to be half to 2 times a frequency as large as f_{LC} provides an appropriate phase margin. It is desirable to set R_s at about 1/20 of (R_1+R_3) to cancel any phase boosting at high frequencies.

Those pole points are summarized in the figure below. The actual frequency property is different from the ideal calculation because of part constants. If possible, check the phase margin with a frequency analyzer or network analyzer. Otherwise, check for the presence or absence of ringing by load response waveform and also check for the presence or absence of oscillation under a load of an adequate margin.

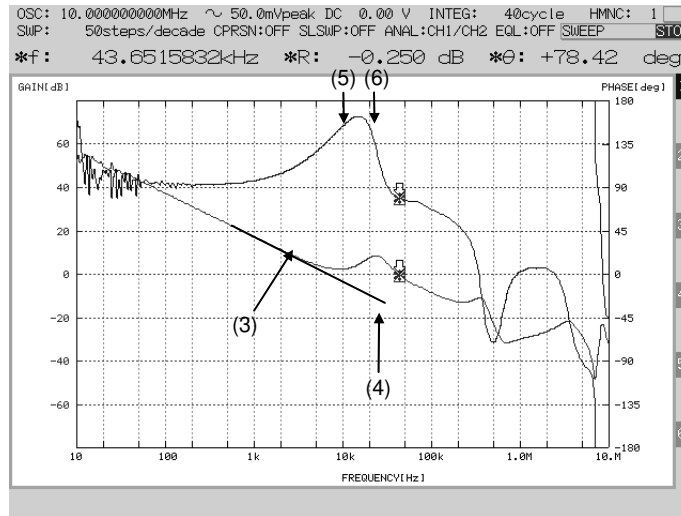
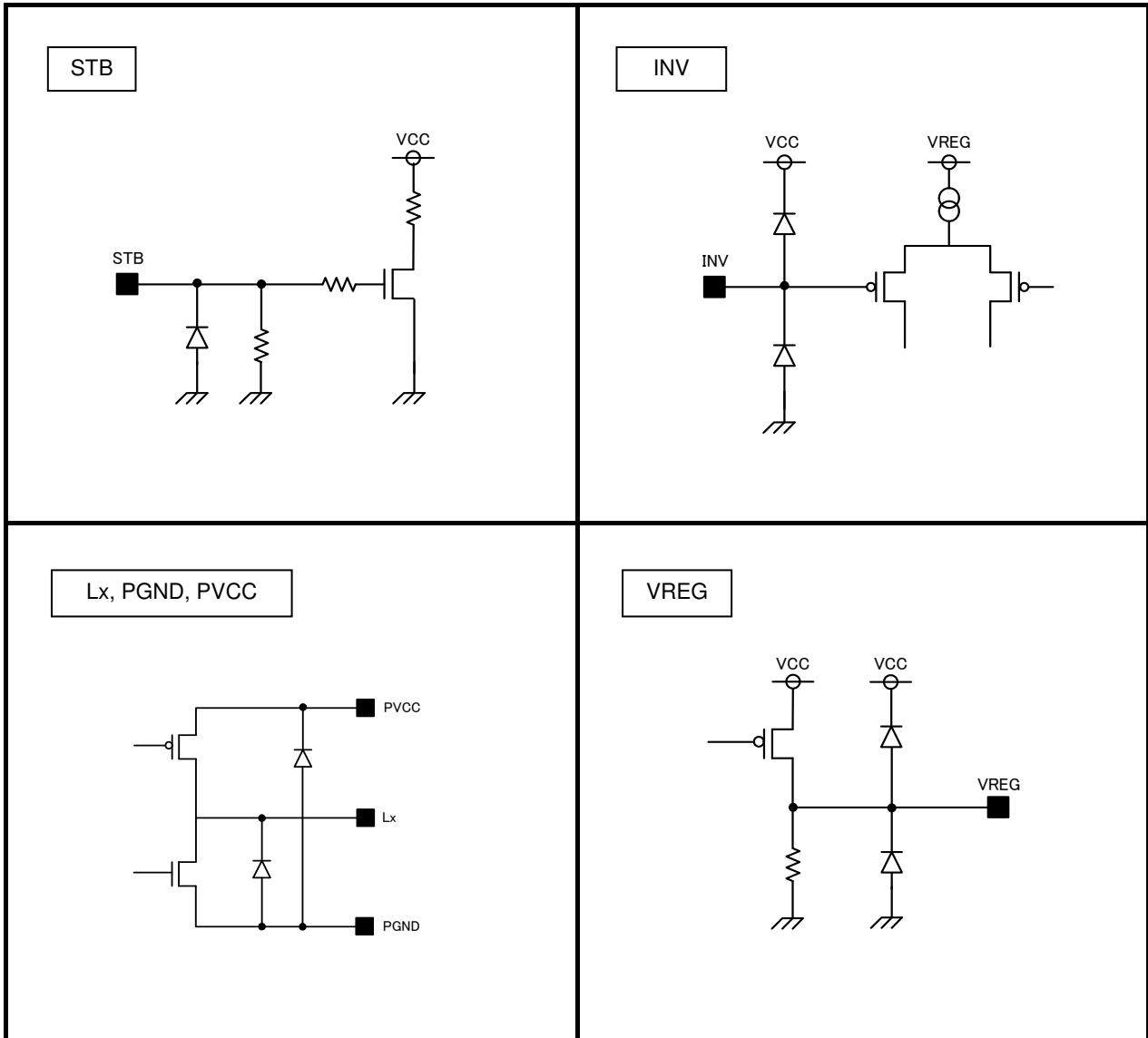

Fig.52 Example of DC/DC converter frequency property (Measured with FRA5097 by NF Corporation)

● I/O Equivalence Circuit



●Ordering part number

- 1) Absolute Maximum Rating
We dedicate much attention to the quality control of these products, however the possibility of deterioration or destruction exists if the impressed voltage, operating temperature range, etc., exceed the absolute maximum ratings. In addition, it is impossible to predict all destructive situations such as short-circuit modes, open circuit modes, etc. If a special mode exceeding the absolute maximum rating is expected, please review matters and provide physical safety means such as fuses, etc.
- 2) GND Potential
Keep the potential of the GND pin below the minimum potential at all times.
- 3) Thermal Design
Work out the thermal design with sufficient margin taking power dissipation (P_d) in the actual operation condition into account.
- 4) Short Circuit between Pins and Incorrect Mounting
Attention to IC direction or displacement is required when installing the IC on a PCB. If the IC is installed in the wrong way, it may break. Also, the threat of destruction from short-circuits exists if foreign matter invades between outputs or the output and GND of the power supply.
- 5) Operation under Strong Electromagnetic Field
Be careful of possible malfunctions under strong electromagnetic fields.
- 6) Common Impedance
When providing a power supply and GND wirings, show sufficient consideration for lowering common impedance and reducing ripple (i.e., using thick short wiring, cutting ripple down by LC, etc.) as much as you can.
- 7) Thermal Protection Circuit (TSD Circuit)
BD8313HFN contains a thermal protection circuit (TSD circuit). The TSD circuit serves to shut off the IC from thermal runaway and does not aim to protect or assure operation of the IC itself. Therefore, do not use the TSD circuit for continuous use or operation after the circuit has tripped.
- 8) Rush Current at the Time of Power Activation
Be careful of the power supply coupling capacity and the width of the power supply and GND pattern wiring and routing since rush current flows instantaneously at the time of power activation in the case of CMOS IC or ICs with multiple power supplies.
- 9) IC Terminal Input
This is a monolithic IC and has P+ isolation and a P substrate for element isolation between each element. P-N junctions are formed and various parasitic elements are configured using these P layers and N layers of the individual elements. For example, if a resistor and transistor are connected to a terminal as shown on Fig.53:
 - The P-N junction operates as a parasitic diode when $GND >$ (Terminal A) in the case of a resistor or when $GND >$ (Terminal B) in the case of a transistor (NPN)
 - Also, a parasitic NPN transistor operates using the N layer of another element adjacent to the previous diode in the case of a transistor (NPN) when $GND >$ (Terminal B).
 The parasitic element consequently rises under the potential relationship because of the IC's structure. The parasitic element pulls interference that could cause malfunctions or destruction out of the circuit. Therefore, use caution to avoid the operation of parasitic elements caused by applying voltage to an input terminal lower than the GND (P board), etc.

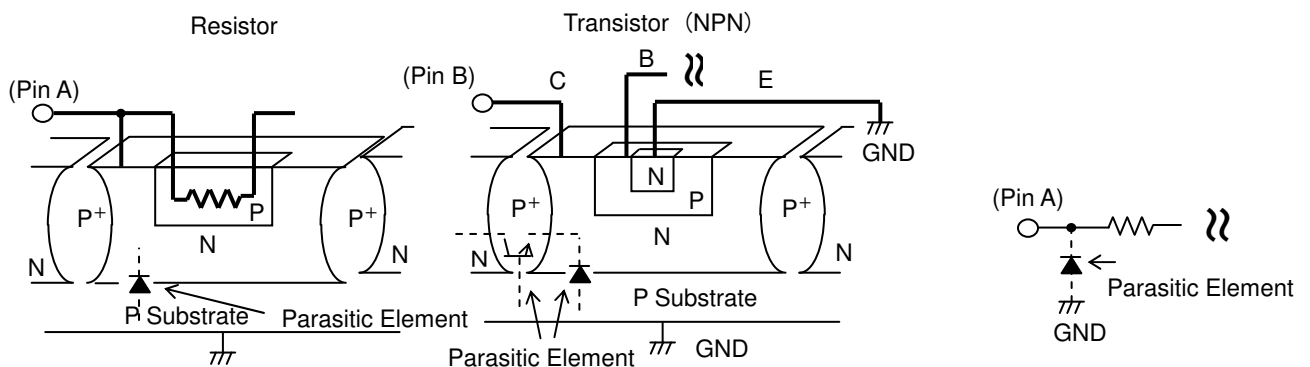
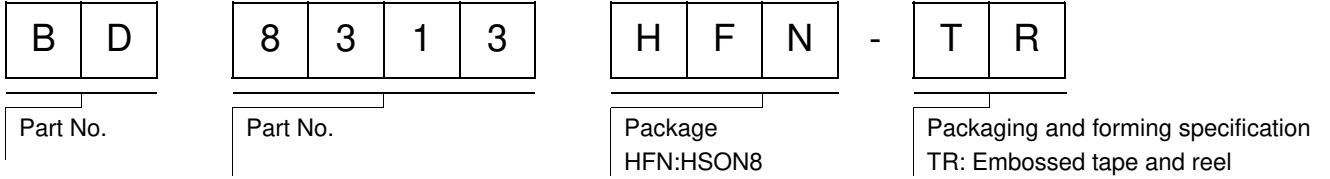
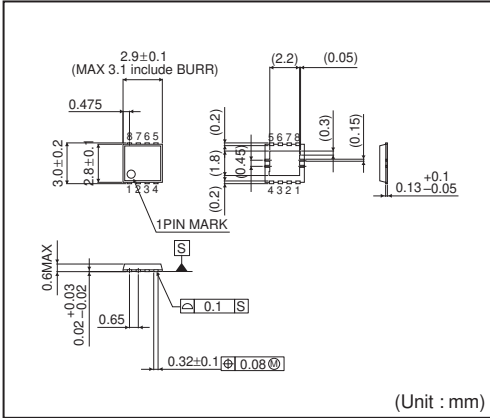

Fig.53 Example of simple structure of Bipolar IC

● Ordering part number



HSO8



<Tape and Reel information>

Tape	Embossed carrier tape
Quantity	3000pcs
Direction of feed	TR (The direction is the 1pin of product is at the upper right when you hold reel on the left hand and you pull out the tape on the right hand)

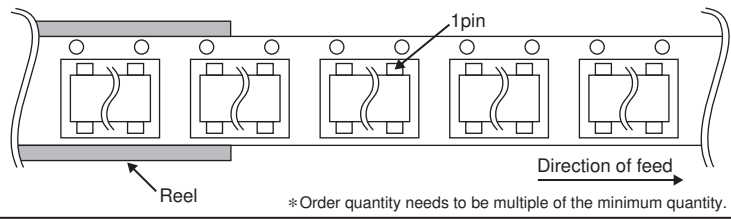

Notes

No copying or reproduction of this document, in part or in whole, is permitted without the consent of ROHM Co.,Ltd.

The content specified herein is subject to change for improvement without notice.

The content specified herein is for the purpose of introducing ROHM's products (hereinafter "Products"). If you wish to use any such Product, please be sure to refer to the specifications, which can be obtained from ROHM upon request.

Examples of application circuits, circuit constants and any other information contained herein illustrate the standard usage and operations of the Products. The peripheral conditions must be taken into account when designing circuits for mass production.

Great care was taken in ensuring the accuracy of the information specified in this document. However, should you incur any damage arising from any inaccuracy or misprint of such information, ROHM shall bear no responsibility for such damage.

The technical information specified herein is intended only to show the typical functions of and examples of application circuits for the Products. ROHM does not grant you, explicitly or implicitly, any license to use or exercise intellectual property or other rights held by ROHM and other parties. ROHM shall bear no responsibility whatsoever for any dispute arising from the use of such technical information.

The Products specified in this document are intended to be used with general-use electronic equipment or devices (such as audio visual equipment, office-automation equipment, communication devices, electronic appliances and amusement devices).

The Products specified in this document are not designed to be radiation tolerant.

While ROHM always makes efforts to enhance the quality and reliability of its Products, a Product may fail or malfunction for a variety of reasons.

Please be sure to implement in your equipment using the Products safety measures to guard against the possibility of physical injury, fire or any other damage caused in the event of the failure of any Product, such as derating, redundancy, fire control and fail-safe designs. ROHM shall bear no responsibility whatsoever for your use of any Product outside of the prescribed scope or not in accordance with the instruction manual.

The Products are not designed or manufactured to be used with any equipment, device or system which requires an extremely high level of reliability the failure or malfunction of which may result in a direct threat to human life or create a risk of human injury (such as a medical instrument, transportation equipment, aerospace machinery, nuclear-reactor controller, fuel-controller or other safety device). ROHM shall bear no responsibility in any way for use of any of the Products for the above special purposes. If a Product is intended to be used for any such special purpose, please contact a ROHM sales representative before purchasing.

If you intend to export or ship overseas any Product or technology specified herein that may be controlled under the Foreign Exchange and the Foreign Trade Law, you will be required to obtain a license or permit under the Law.



Thank you for your accessing to ROHM product informations.
More detail product informations and catalogs are available, please contact us.

ROHM Customer Support System

<http://www.rohm.com/contact/>