



Chipsmall Limited consists of a professional team with an average of over 10 year of expertise in the distribution of electronic components. Based in Hongkong, we have already established firm and mutual-benefit business relationships with customers from,Europe,America and south Asia,supplying obsolete and hard-to-find components to meet their specific needs.

With the principle of “Quality Parts,Customers Priority,Honest Operation,and Considerate Service”,our business mainly focus on the distribution of electronic components. Line cards we deal with include Microchip,ALPS,ROHM,Xilinx,Pulse,ON,Everlight and Freescale. Main products comprise IC,Modules,Potentiometer,IC Socket,Relay,Connector.Our parts cover such applications as commercial,industrial, and automotives areas.

We are looking forward to setting up business relationship with you and hope to provide you with the best service and solution. Let us make a better world for our industry!



Contact us

Tel: +86-755-8981 8866 Fax: +86-755-8427 6832

Email & Skype: info@chipsmall.com Web: www.chipsmall.com

Address: A1208, Overseas Decoration Building, #122 Zhenhua RD., Futian, Shenzhen, China



Serial-in Parallel-out LED Driver 8ch LED Driver IC with 3-line Serial Interface

BD8378FV-M

General Description

The BD8378FV-M is a serial-in parallel-out controlled LED driver with 35V output voltage rating. With the input of 3-line serial data, it turns the 8ch open drain output on/off. It is optimal for small space due to its compact size.

Features

- Open Drain Output
- 3-line Serial Control + Enable Signal
- Cascade Connection Compatible
- SSOP-B16 Package
- Internal 8ch Power Transistor
- Output Slew Rate Typical 20V/μs (Typ)
(For Low EMC Noise)
- AEC-Q100 Qualified.

Applications

- For indicator of Cluster Panel.

Key Specifications

- Input Voltage Range: 3.0V to 5.5V
- Output Voltage Range: 35V (Max)
- DC Output Current (per CH): 50mA (Max)
- Output ON-Resistance: 6Ω (Typ)
- Standby Current: 0μA (Typ)
- Operating Temperature Range: -40°C to +105°C

Package

SSOP-B16

W(Typ) x D(Typ) x H(Max)
5.00mm x 6.40mm x 1.35mm

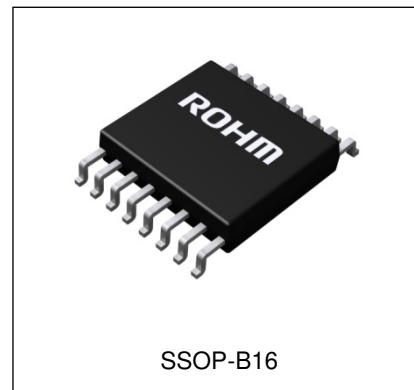

Typical Application Circuit

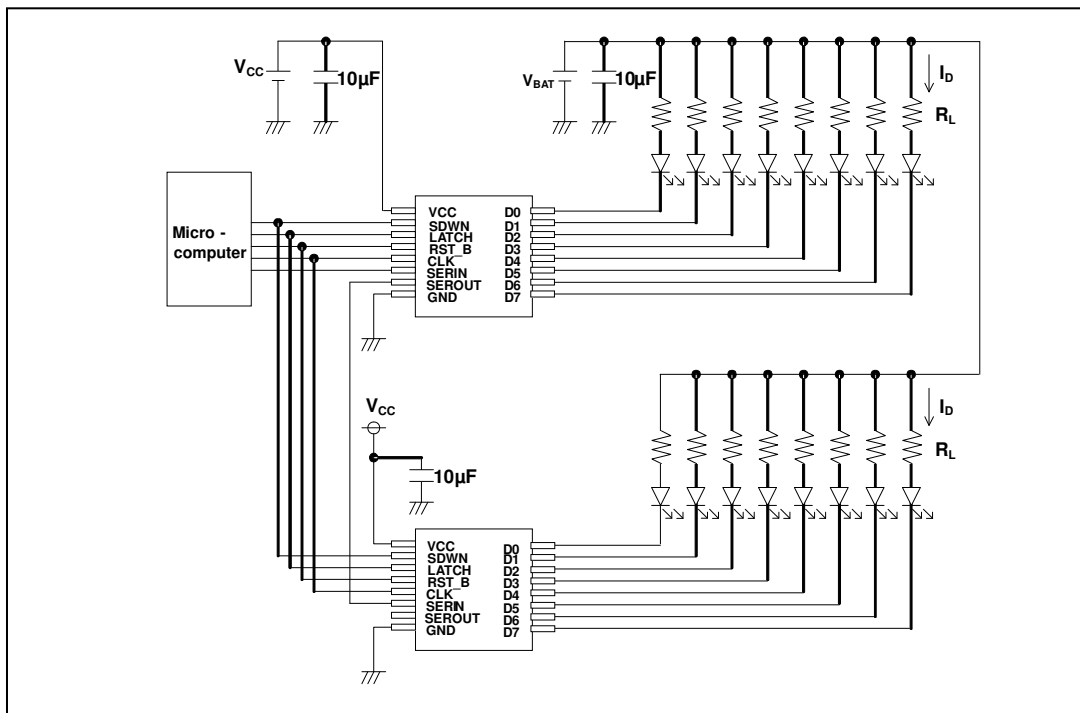

Figure 1. Typical Application Circuit

Product structure : Silicon monolithic integrated circuit OThis product has no designed protection against radioactive rays.

www.rohm.com

© 2013 ROHM Co., Ltd. All rights reserved.

TSZ22111 · 14 · 001

Pin Configuration

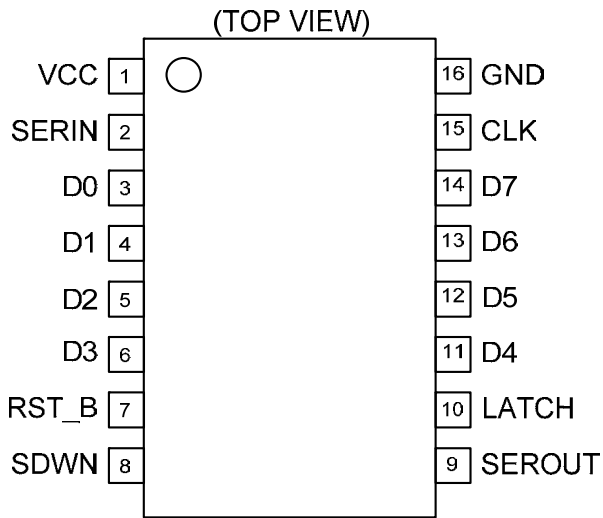

Figure 2. Pin Configuration

Pin Descriptions

Pin No.	Symbol	Function
1	VCC	Power supply voltage input
2	SERIN	Serial data input
3	D0	Drain output 0
4	D1	Drain output 1
5	D2	Drain output 2
6	D3	Drain output 3
7	RST_B	Reset return input (Low: FF data 0)
8	SDWN	Shutdown enable (High: Output OFF)
9	SEROUT	Serial data output
10	LATCH	Latch signal input (High: Data latch)
11	D4	Drain output 4
12	D5	Drain output 5
13	D6	Drain output 6
14	D7	Drain output 7
15	CLK	Clock input
16	GND	Ground

Block Diagram

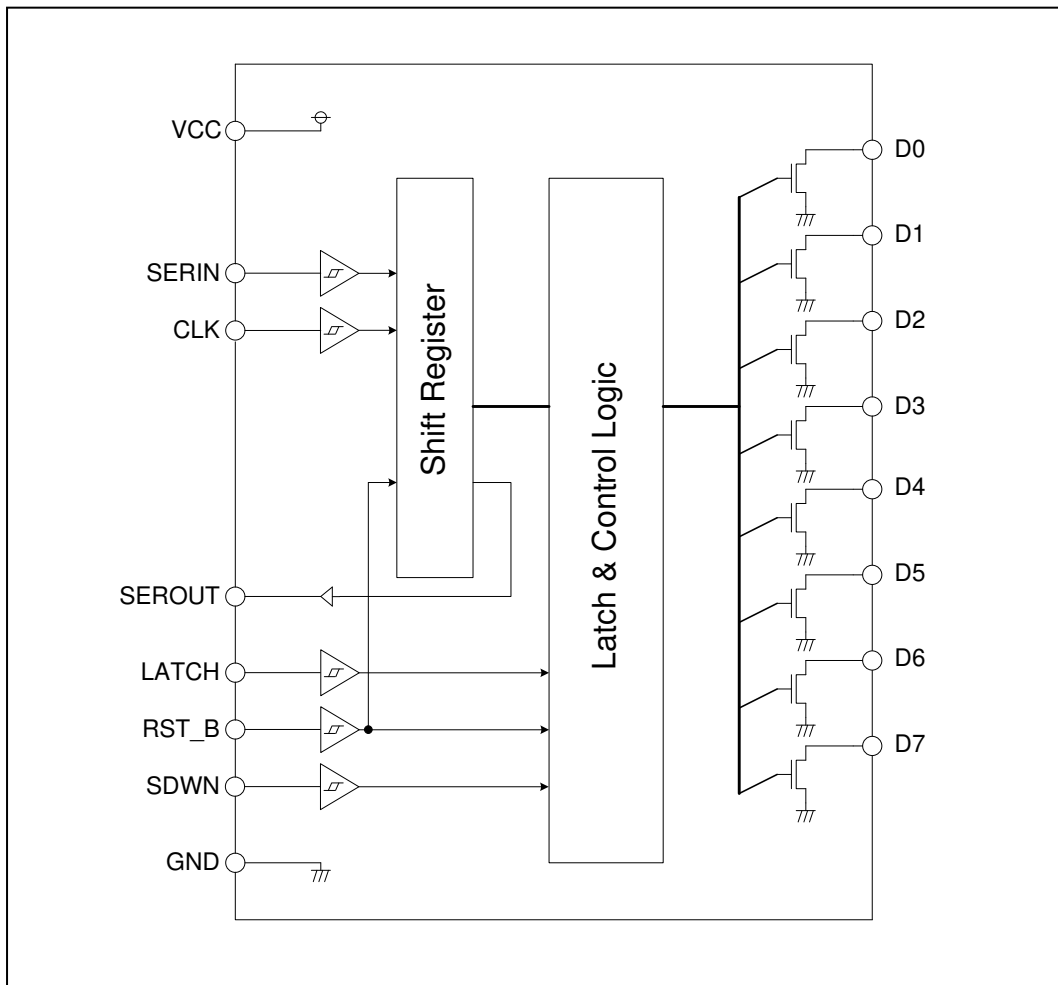

Figure 3. Block Diagram

Absolute Maximum Ratings

Item	Symbol	Value	Unit
Power Supply Voltage	V_{CC}	7	V
Output Voltage	V_{Dmax}	35	V
Input Voltage	V_{IN}	-0.3 to V_{CC}	V
Power Dissipation	P_d	0.87 ^(Note 1)	W
Operating Temperature Range	T_{opr}	-40 to +105	°C
Storage Temperature Range	T_{stg}	-55 to +150	°C
Drive Current (DC)	I_{omaxD}	50	mA
Drive Current (Pulse)	I_{omaxP}	150 ^(Note 2)	mA
Junction Temperature	T_{jmax}	150	°C

(Note 1) P_d is decreased by 7.0mW/°C for temperatures above $T_a=25^{\circ}\text{C}$, mounted on 70mm x70mm x1.6mm Glass-epoxy PCB.

(Note 2) Do not however exceed P_d . Time to impress $\leq 200\text{ms}$.

Caution: Operating the IC over the absolute maximum ratings may damage the IC. The damage can either be a short circuit between pins or an open circuit between pins and the internal circuitry. Therefore, it is important to consider circuit protection measures, such as adding a fuse, in case the IC is operated over the absolute maximum ratings.

Recommended Operating Conditions

Item	Symbol	Value	Unit
Power Supply Voltage	V_{CC}	3.0 to 5.5	V
Operational Temperature	T_{opr}	-40 to 105	°C

Electrical Characteristics

(Unless specified, Ta=-40 to 105°C VCC=3.0 to 5.5V)

Item	Symbol	Standard Value			Unit	Conditions
		Min	Typ	Max		
【Output D0~D7】						
ON Resistor1	R _{ON1}	-	6	12	Ω	I _D =20mA, V _{CC} =4.5V to 5.5V
ON Resistor2	R _{ON2}	-	9	18	Ω	I _D =20mA, V _{CC} =3.0V to 4.5V
Output Leakage Current	I _{DL}	-	-	0.3	μA	V _D =34V, Ta=-40 to 125°C
【Logic input】						
Upper Limit Threshold Voltage1	V _{TH1}	$V_{CC} \times 0.5$	-	-	V	V _{CC} =4.5V to 5.5V
Upper Limit Threshold Voltage2	V _{TH2}	$V_{CC} \times 0.6$	-	-	V	V _{CC} =3.0V to 4.5V
Bottom Limit Threshold Voltage1	V _{TL1}	-	-	$V_{CC} \times 0.2$	V	V _{CC} =4.5V to 5.5V
Bottom Limit Threshold Voltage2	V _{TL2}	-	-	$V_{CC} \times 0.3$	V	V _{CC} =3.0V to 4.5V
SDWN Hysteresis Width	V _{HYS}	0.15	0.30	0.50	V	V _{CC} =5.0V, SDWN Pin
Serial Clock Frequency	F _{CLK}	-	-	1.25	MHz	
Input Leakage Current L	I _{INLL}	-5	0	-	μA	V _{IN} =0V
Input Leakage Current H	I _{INLH}	-	0	5	μA	V _{IN} =5V
【WHOLE】						
Circuit Current	I _{CC}	-	0.3	1	mA	Serial Data Input, V _{CC} =5V, CLK=500kHz, SEROUT=OPEN
Static Current	I _{STN}	-	0	50	μA	SEROUT=OPEN
【SEROUT】						
Output Voltage High1	V _{OH1}	4.6	4.8	-	V	V _{CC} =5V, I _{SO} =-4mA
Output Voltage Low1	V _{OL1}	-	0.2	0.4	V	V _{CC} =5V, I _{SO} =4mA
Output Voltage High2	V _{OH2}	2.7	3.0	-	V	V _{CC} =3.3V, I _{SO} =-4mA
Output Voltage Low2	V _{OL2}	-	0.3	0.6	V	V _{CC} =3.3V, I _{SO} =4mA

Typical Performance Curves

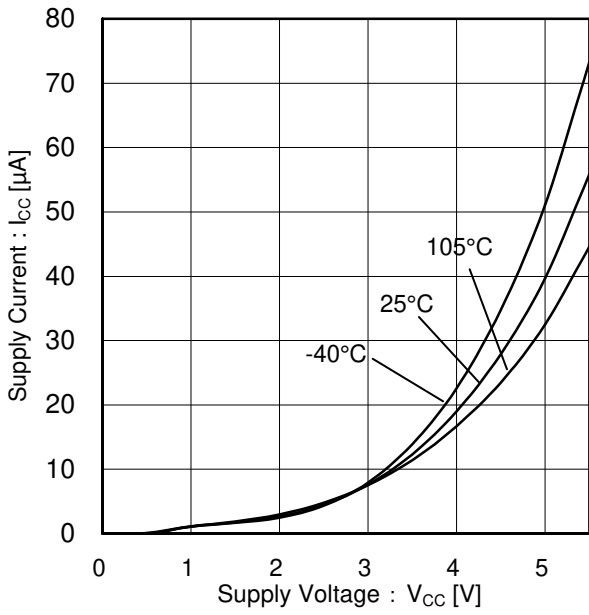

Figure 4. Circuit Current (VCC characteristic)

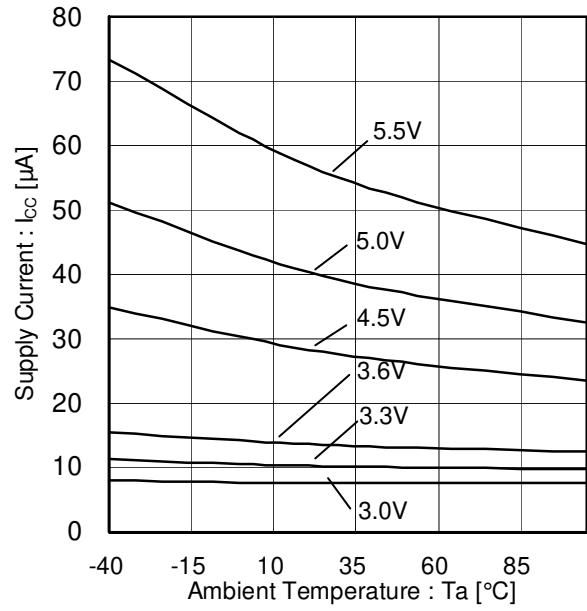

Figure 5. Circuit Current (Temperature characteristic)

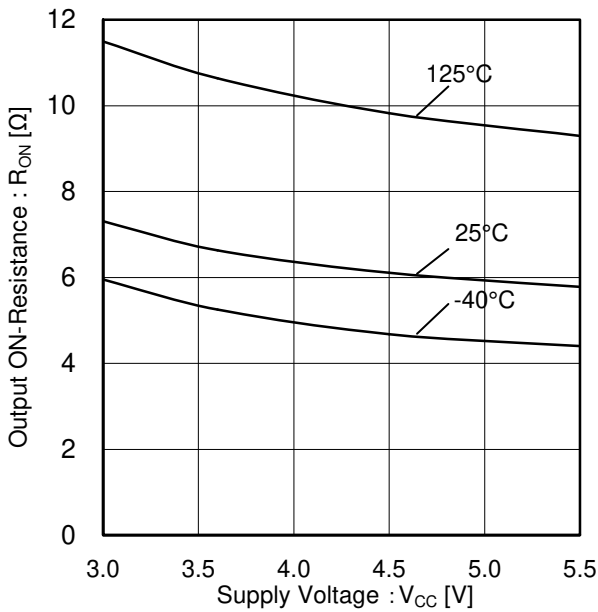

Figure 6. Output ON Resistance (VCC characteristic @ ID=20mA)

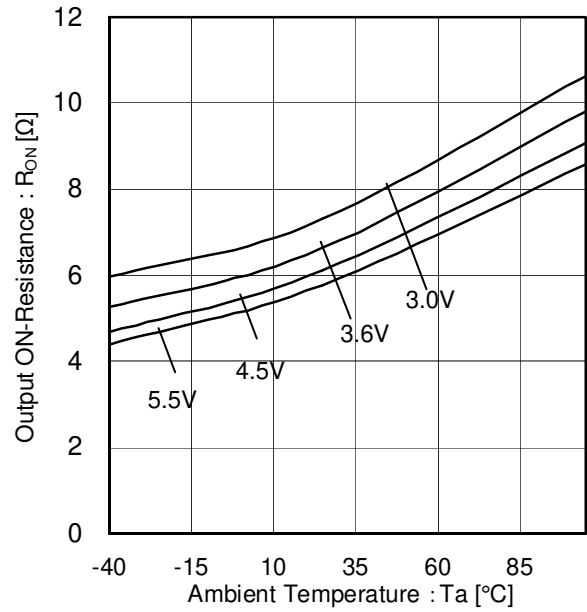

Figure 7. Output ON Resistance (Temperature characteristic @ ID=20mA)

Typical Performance Curves - continued

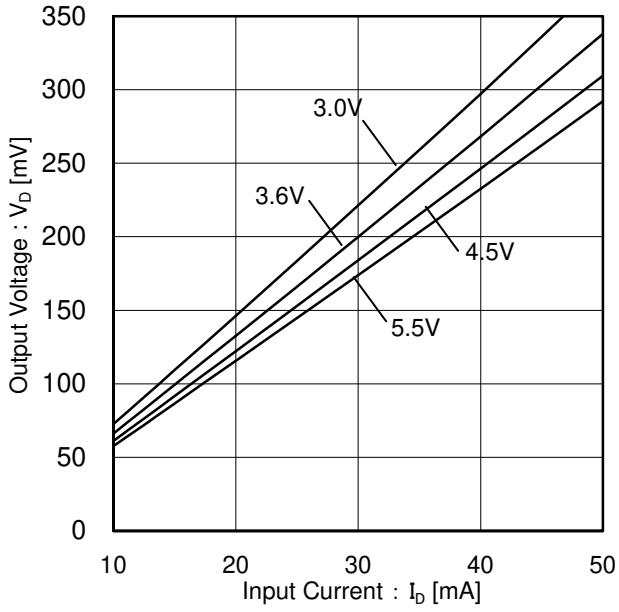

Figure 8. Output ON Resistance (I_b characteristic)

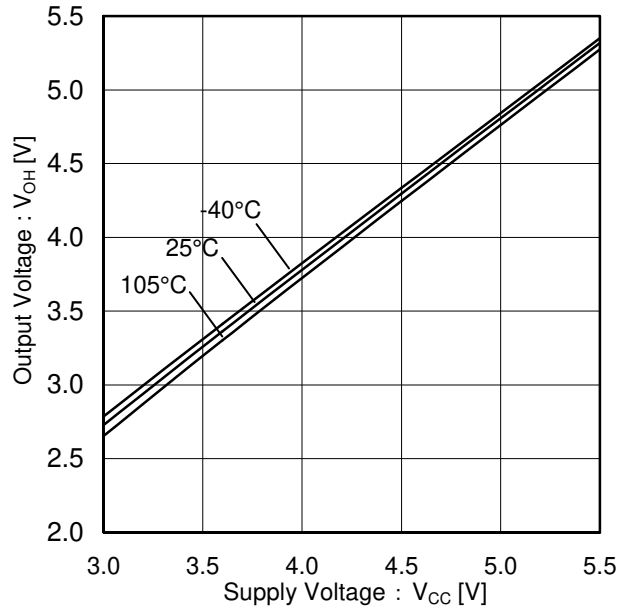

Figure 9. SEROUT High Side Voltage (V_{CC} characteristic @ $I_{SO}=-4mA$)

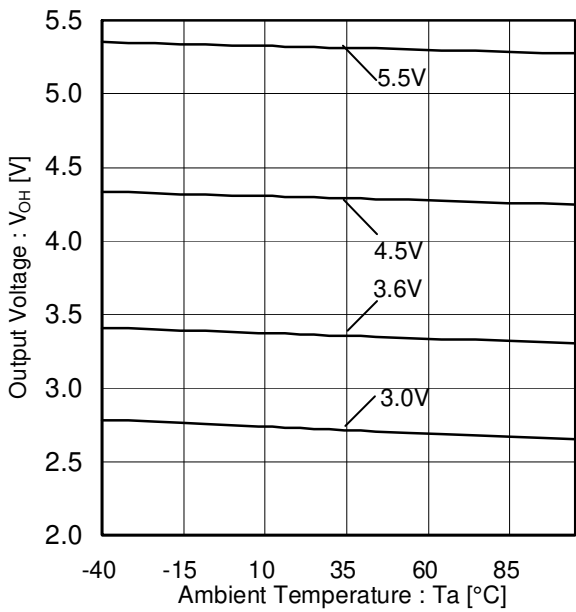

Figure 10. SEROUT High Side Voltage (Temperature characteristic @ $I_{SO}=-4mA$)

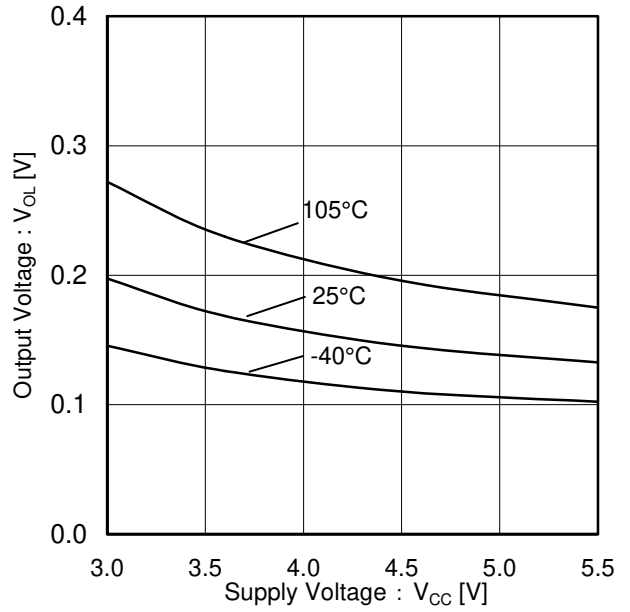

Figure 11. SEROUT Low Side Voltage (V_{CC} characteristic @ $I_{SO}=4mA$)

Typical Performance Curves - continued

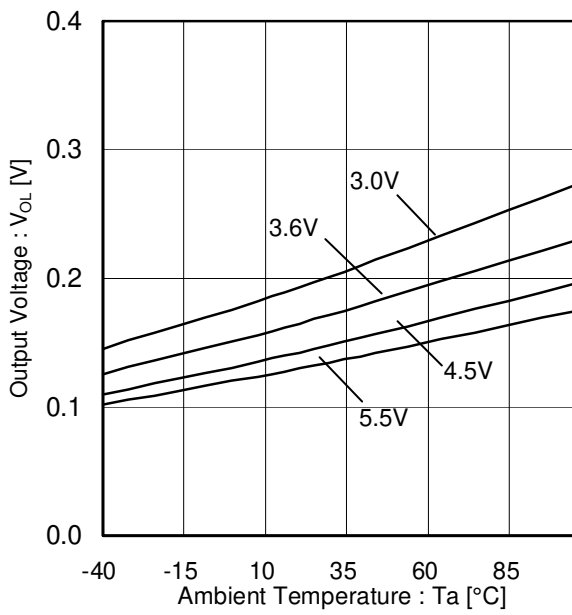

Figure 12. SEROUT Low Side Voltage (Temperature characteristic @ ISO=4mA)

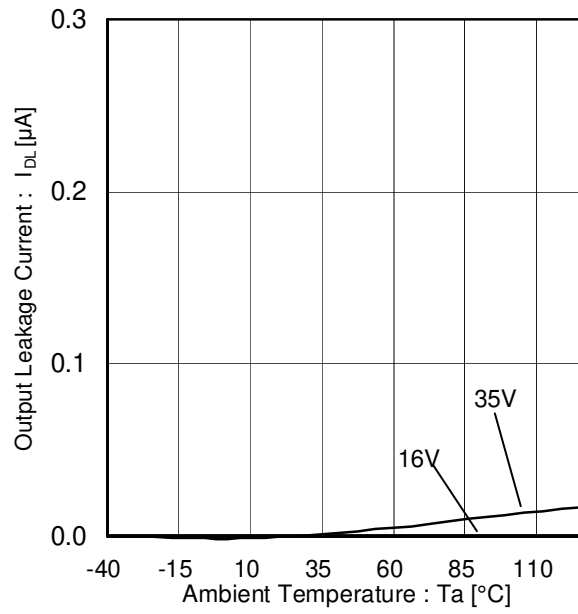

Figure 13. Output Leakage Current (Temperature characteristic)

Serial Communication

The serial interface is composed of a shift register which changes the clock “CLK” and serial “SERIN” signals to parallel signals and a register to store those signals with a LATCH signal. The registers are reset by applying a voltage below V_{TL} to the RST_B terminal causing D7 to D0 to become open. Erroneous LED lighting could be prevented by applying a voltage below V_{TL} to RST_B during start-up.

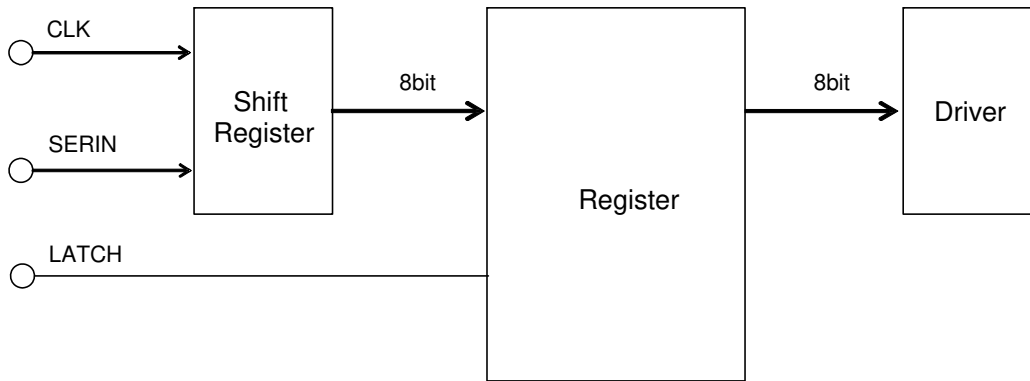

Figure 14. Block Diagram of Serial Communication

1) Serial Communication Timing

The 8-bit serial data input from SERIN is taken into the shift register by the rising edge of the CLK signal and is recorded in the register by the rising edge of the LATCH signal. The recorded data is valid until the next rising edge of the LATCH signal.

2) Serial Communication Data

The serial data input configuration of SERIN terminal is shown below:

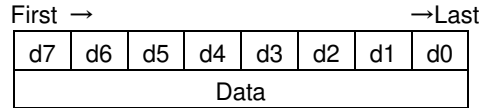

Terminal	Output Condition	Data							
		d7	d6	d5	d4	d3	d2	d1	d0
D7	ON	1	*	*	*	*	*	*	*
	OFF	0	*	*	*	*	*	*	*
D6	ON	*	1	*	*	*	*	*	*
	OFF	*	0	*	*	*	*	*	*
D5	ON	*	*	1	*	*	*	*	*
	OFF	*	*	0	*	*	*	*	*
D4	ON	*	*	*	1	*	*	*	*
	OFF	*	*	*	0	*	*	*	*
D3	ON	*	*	*	*	1	*	*	*
	OFF	*	*	*	*	0	*	*	*
D2	ON	*	*	*	*	*	1	*	*
	OFF	*	*	*	*	*	0	*	*
D1	ON	*	*	*	*	*	*	1	*
	OFF	*	*	*	*	*	*	0	*
D0	ON	*	*	*	*	*	*	*	1
	OFF	*	*	*	*	*	*	*	0

* indicate don't care

3) Enable Signal

By applying voltage at least V_{TH} or more to the SDWN terminal, D7 to D0 become open forcibly.
 D7 to D0 become PWM operation by having the PWM signal to the SDWN terminal.

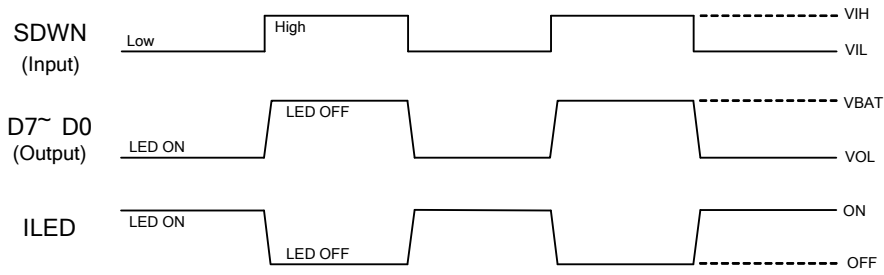

Figure 15. PWM Signal

4) SEROUT

A cascade connection can be made (connecting at least 2 or more IC's in serial).
 Serial signal input from SERIN is transferred into receiver IC by the falling edge of the CLK signal.
 Since this functionality gives enough margins for the setup time prior to the rising edge of the CLK signal on the receiver IC (using the exact same CLK signal of sender IC), the application reliability can be improved as cascade connection functionality.

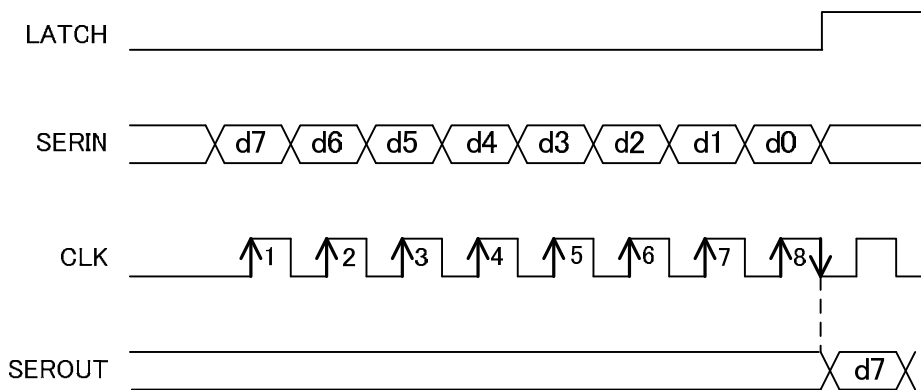

Figure 16. SEROUT Output Signal

Cascade Connection

By using (at least) 2 ICs, each IC's D7 to D0, at (at least) 16ch, can be controlled by the 16-bit SERIN signal.
 The serial data input to the sender IC can be transferred to the receiver IC by inputting 8 CLK to the CLK terminal.

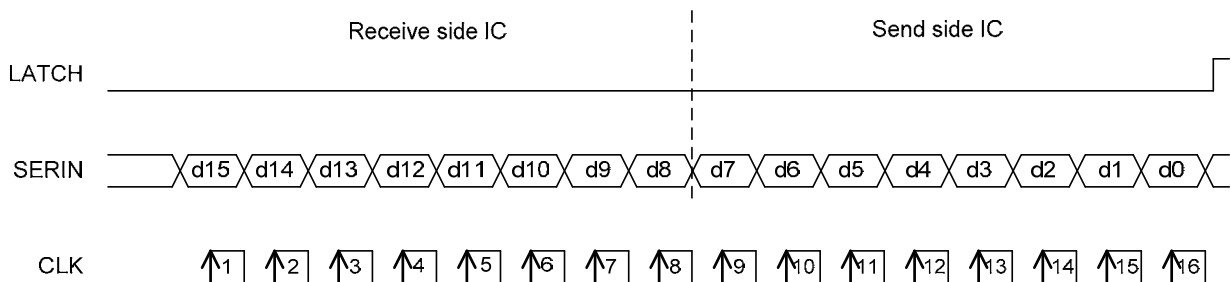

Figure 17. Cascade Connection

INPUT SIGNAL'S TIMING CHART

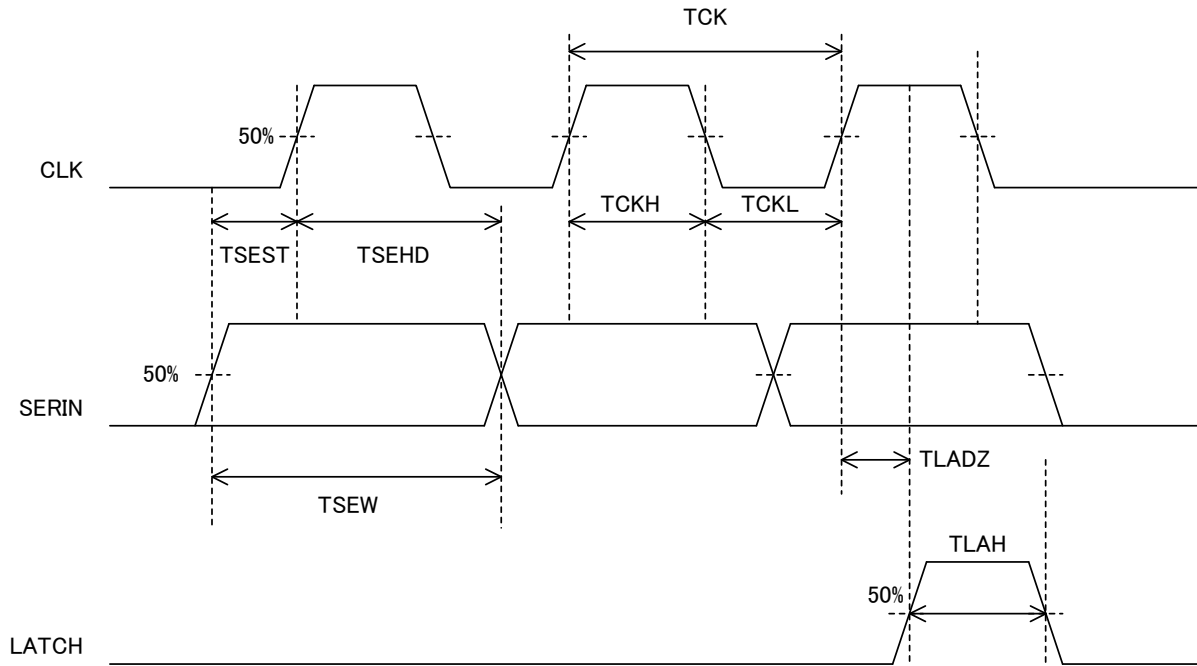

Figure 18. Timing Chart of Input Signal

INPUT SIGNAL'S TIMING RULE (Ta=-40°C to 105°C V_{CC}=3.0V to 5.5V)

Parameter	Symbol	Min	Unit
CLK period	t_{CK}	800	ns
CLK high pulse width	t_{CKH}	380	ns
CLK low pulse width	t_{CKL}	380	ns
SERIN high and low pulse width	t_{SEW}	780	ns
SERIN setup time prior to CLK rise	t_{SEST}	150	ns
SERIN hold time after CLK rise	t_{SEHD}	150	ns
LATCH high pulse time	t_{LAH}	380	ns
Last CLK rise to LATCH rise	t_{LADZ}	200	ns

OUTPUT SIGNAL'S DELAY CHART

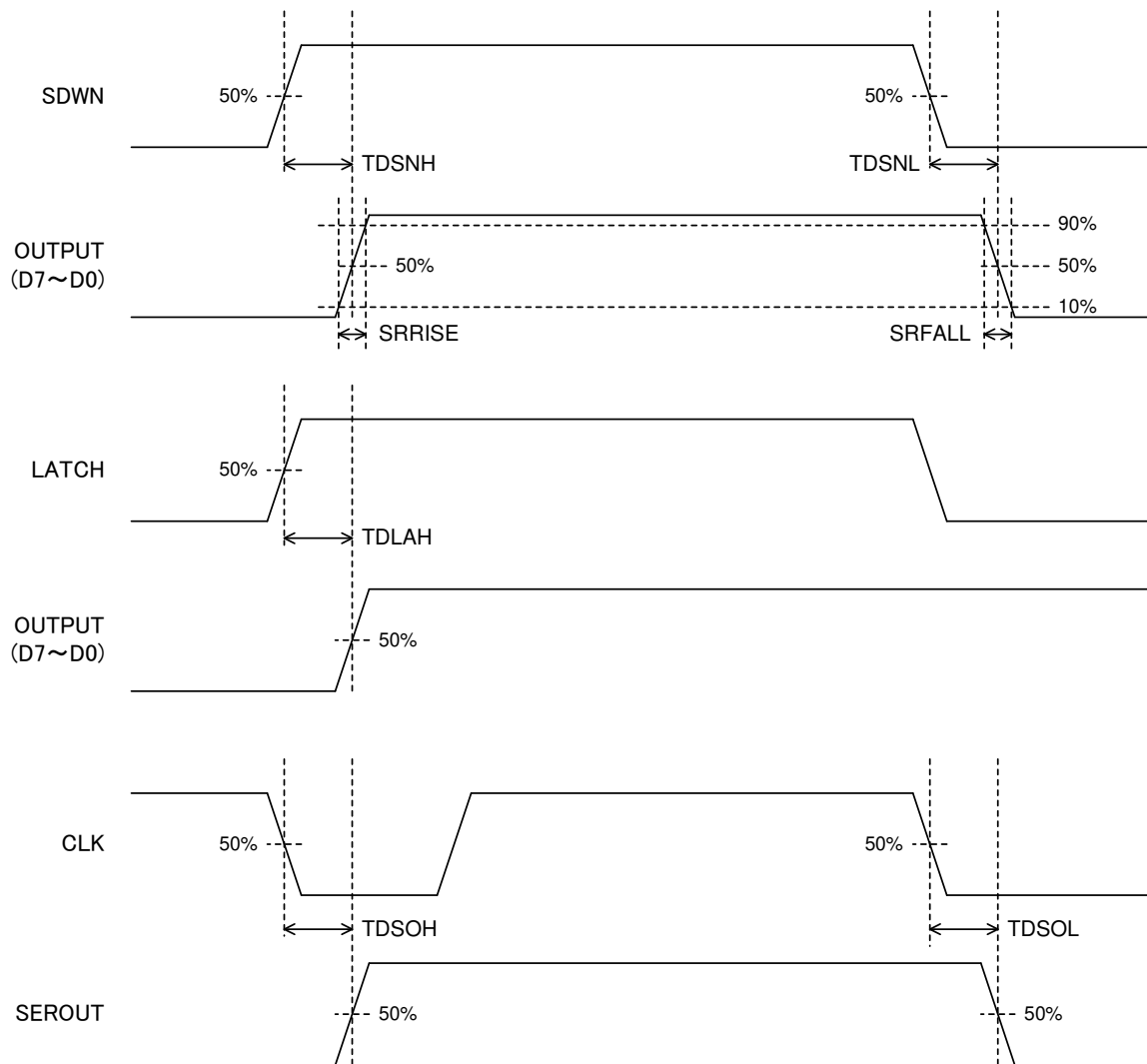
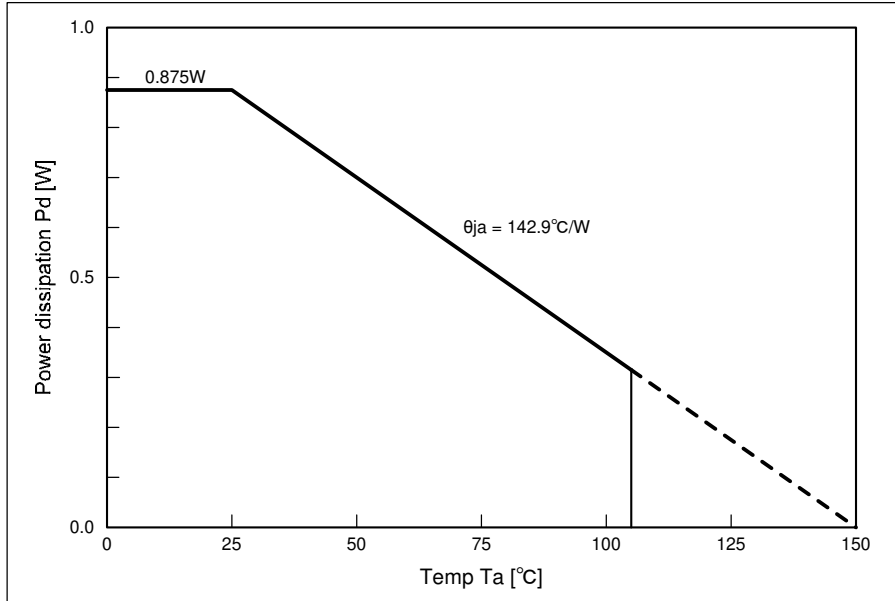

Figure 19. Delay Chart of Output Signal

OUTPUT SIGNAL'S DELAY TIME (Ta=-40°C to 105°C VCC=3.0V to 5.5V)

Parameter	Symbol	Min	Typ	Max	Unit	Condition
SDWN Switching Time (Low→High)	t_{DSNH}	-	-	3000	ns	
SDWN Switching Time (High→Low)	t_{DSNL}	-	-	2000	ns	
LATCH Switching Delay Time	t_{DLAH}	-	-	3000	ns	
SEROUT Propagation Delay Time (Low→High)	t_{DSOH}	-	-	350	ns	
SEROUT Propagation Delay Time (High→Low)	t_{DSOL}	-	-	350	ns	
Rising Slew Rate	SR_{RISE}	-	20	-	V/μs	Ta=25°C, VCC=5V, RL=500Ω, VBAT=10V
Falling Slew Rate	SR_{FALL}	-	20	-	V/μs	Ta=25°C, VCC=5V, RL=500Ω, VBAT=10V

Power Dissipation



Note 1 : Power dissipation is calculated when mounted on 70mm X 70mm X 1.6mm glass epoxy substrate.

Note 2 : Power dissipation changes with copper foil density of the board.

Figure 20. SSOP-B16 Power Dissipation

I/O Equivalence Circuits

<p>Pin2 (SERIN) Pin7 (RST_B) Pin8 (SDWN) Pin10 (LATCH) Pin15 (CLK)</p>	<p>Pin3 (D0), Pin4 (D1), Pin5 (D2), Pin6 (D3), Pin11(D4), Pin12 (D5), Pin13 (D6), Pin14 (D7)</p>	<p>Pin9 (SEROUT)</p>

Operational Notes

1. Reverse Connection of Power Supply

Connecting the power supply in reverse polarity can damage the IC. Take precautions against reverse polarity when connecting the power supply, such as mounting an external diode between the power supply and the IC's power supply pins.

2. Power Supply Lines

Design the PCB layout pattern to provide low impedance supply lines. Separate the ground and supply lines of the digital and analog blocks to prevent noise in the ground and supply lines of the digital block from affecting the analog block. Furthermore, connect a capacitor to ground at all power supply pins. Consider the effect of temperature and aging on the capacitance value when using electrolytic capacitors.

3. Ground Voltage

Ensure that no pins are at a voltage below that of the ground pin at any time, even during transient condition.

4. Ground Wiring Pattern

When using both small-signal and large-current ground traces, the two ground traces should be routed separately but connected to a single ground at the reference point of the application board to avoid fluctuations in the small-signal ground caused by large currents. Also ensure that the ground traces of external components do not cause variations on the ground voltage. The ground lines must be as short and thick as possible to reduce line impedance.

5. Thermal Consideration

Should by any chance the power dissipation rating be exceeded the rise in temperature of the chip may result in deterioration of the properties of the chip. The absolute maximum rating of the Pd stated in this specification is when the IC is mounted on a 70mm x 70mm x 1.6mm glass epoxy board. In case of exceeding this absolute maximum rating, increase the board size and copper area to prevent exceeding the Pd rating.

6. Recommended Operating Conditions

These conditions represent a range within which the expected characteristics of the IC can be approximately obtained. The electrical characteristics are guaranteed under the conditions of each parameter.

7. Inrush Current

When power is first supplied to the IC, it is possible that the internal logic may be unstable and inrush current may flow instantaneously due to the internal powering sequence and delays, especially if the IC has more than one power supply. Therefore, give special consideration to power coupling capacitance, power wiring, width of ground wiring, and routing of connections.

8. Operation Under Strong Electromagnetic Field

Operating the IC in the presence of a strong electromagnetic field **may cause the IC to malfunction.**

9. Testing on Application Boards

When testing the IC on an application board, connecting a capacitor directly to a low-impedance output pin may subject the IC to stress. Always discharge capacitors completely after each process or step. The IC's power supply should always be turned off completely before connecting or removing it from the test setup during the inspection process. To prevent damage from static discharge, ground the IC during assembly and use similar precautions during transport and storage.

10. Inter-pin Short and Mounting Errors

Ensure that the direction and position are correct when mounting the IC on the PCB. Incorrect mounting may result in damaging the IC. Avoid nearby pins being shorted to each other especially to ground, power supply and output pin. Inter-pin shorts could be due to many reasons such as metal particles, water droplets (in very humid environment) and unintentional solder bridge deposited in between pins during assembly to name a few.

Operational Notes – continued

11. Unused Input Pins

Input pins of an IC are often connected to the gate of a MOS transistor. The gate has extremely high impedance and extremely low capacitance. If left unconnected, the electric field from the outside can easily charge it. The small charge acquired in this way is enough to produce a significant effect on the conduction through the transistor and cause unexpected operation of the IC. So unless otherwise specified, unused input pins should be connected to the power supply or ground line.

12. Regarding the Input Pin of the IC

This monolithic IC contains P+ isolation and P substrate layers between adjacent elements in order to keep them isolated. P-N junctions are formed at the intersection of the P layers with the N layers of other elements, creating a parasitic diode or transistor. For example (refer to figure below):

When $GND > Pin A$ and $GND > Pin B$, the P-N junction operates as a parasitic diode.

When $GND > Pin B$, the P-N junction operates as a parasitic transistor.

Parasitic diodes inevitably occur in the structure of the IC. The operation of parasitic diodes can result in mutual interference among circuits, operational faults, or physical damage. Therefore, conditions that cause these diodes to operate, such as applying a voltage lower than the GND voltage to an input pin (and thus to the P substrate) should be avoided.

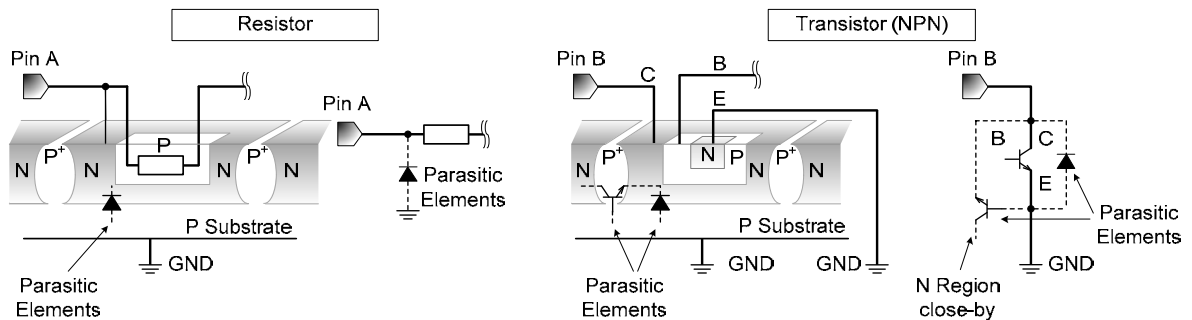

Figure 21. Example of monolithic IC structure

13. Ceramic Capacitor

When using a ceramic capacitor, determine the dielectric constant considering the change of capacitance with temperature and the decrease in nominal capacitance due to DC bias and others.

14. Area of Safe Operation (ASO)

Operate the IC such that the output voltage, output current, and power dissipation are all within the Area of Safe Operation (ASO).

Ordering Information

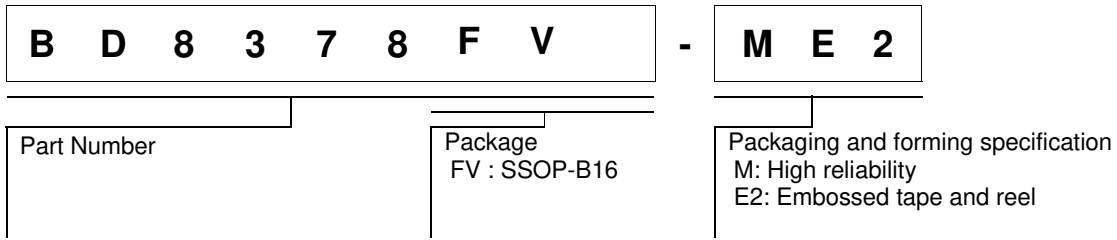

Marking Diagram (TOP VIEW)

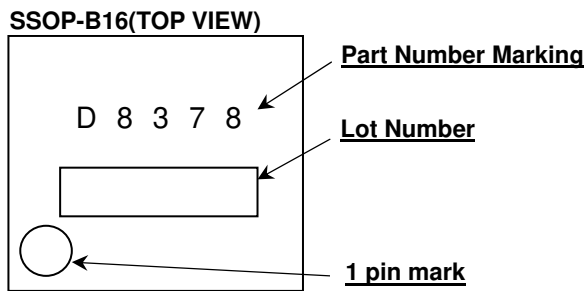

Physical Dimension, Tape and Reel Information

Package Name	SSOP-B16
---------------------	-----------------

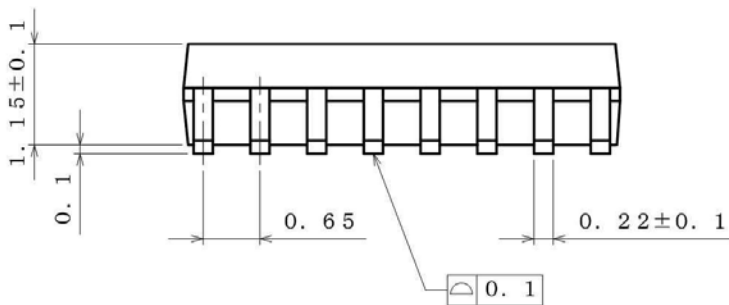
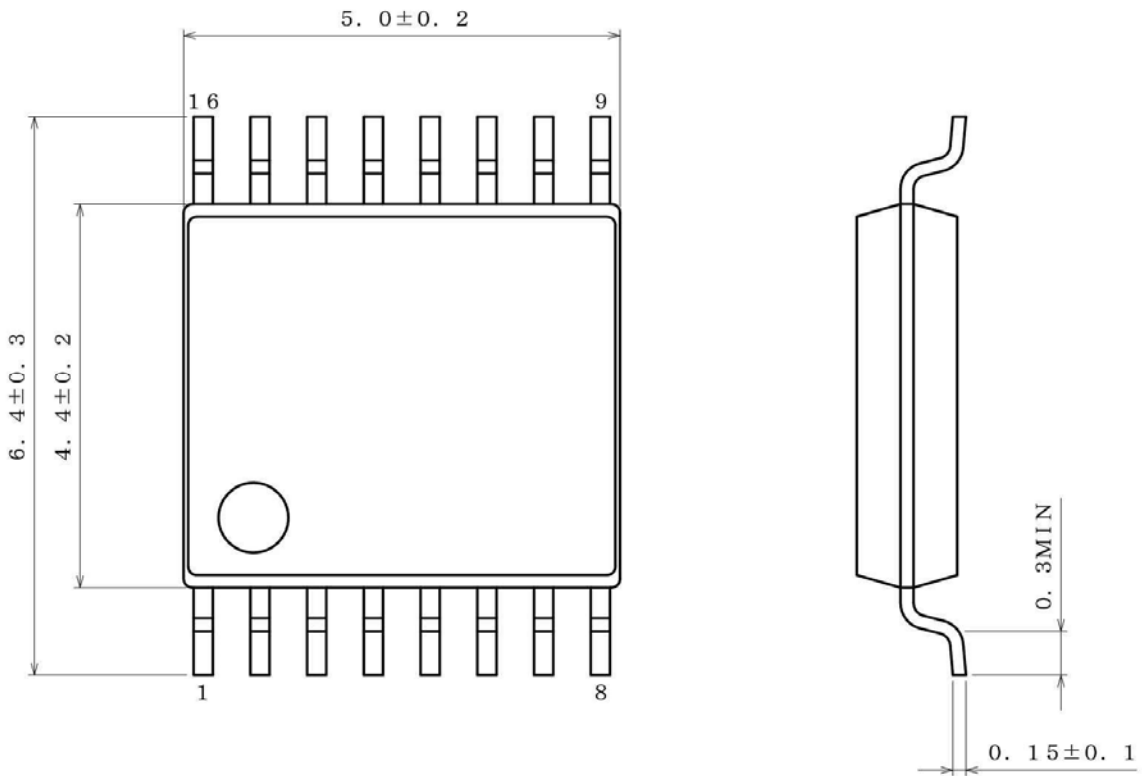

(UNIT : mm)
 PKG : SSOP-B16
 Drawing No. B0771

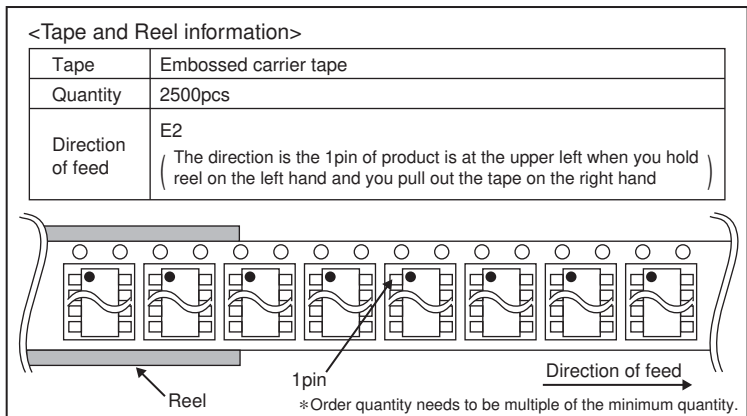

Revision History

Date	Revision	Changes
14.Nov.2013	001	New Release
01.Oct.2014	002	P1 Add AEC-Q100 Qualified

Notice

Precaution on using ROHM Products

1. If you intend to use our Products in devices requiring extremely high reliability (such as medical equipment ^(Note 1), aircraft/spacecraft, nuclear power controllers, etc.) and whose malfunction or failure may cause loss of human life, bodily injury or serious damage to property ("Specific Applications"), please consult with the ROHM sales representative in advance. Unless otherwise agreed in writing by ROHM in advance, ROHM shall not be in any way responsible or liable for any damages, expenses or losses incurred by you or third parties arising from the use of any ROHM's Products for Specific Applications.

(Note1) Medical Equipment Classification of the Specific Applications

JAPAN	USA	EU	CHINA
CLASS III	CLASS III	CLASS II b	CLASS III
CLASS IV		CLASS III	

2. ROHM designs and manufactures its Products subject to strict quality control system. However, semiconductor products can fail or malfunction at a certain rate. Please be sure to implement, at your own responsibilities, adequate safety measures including but not limited to fail-safe design against the physical injury, damage to any property, which a failure or malfunction of our Products may cause. The following are examples of safety measures:
 - [a] Installation of protection circuits or other protective devices to improve system safety
 - [b] Installation of redundant circuits to reduce the impact of single or multiple circuit failure
3. Our Products are not designed under any special or extraordinary environments or conditions, as exemplified below. Accordingly, ROHM shall not be in any way responsible or liable for any damages, expenses or losses arising from the use of any ROHM's Products under any special or extraordinary environments or conditions. If you intend to use our Products under any special or extraordinary environments or conditions (as exemplified below), your independent verification and confirmation of product performance, reliability, etc. prior to use, must be necessary:
 - [a] Use of our Products in any types of liquid, including water, oils, chemicals, and organic solvents
 - [b] Use of our Products outdoors or in places where the Products are exposed to direct sunlight or dust
 - [c] Use of our Products in places where the Products are exposed to sea wind or corrosive gases, including Cl₂, H₂S, NH₃, SO₂, and NO₂
 - [d] Use of our Products in places where the Products are exposed to static electricity or electromagnetic waves
 - [e] Use of our Products in proximity to heat-producing components, plastic cords, or other flammable items
 - [f] Sealing or coating our Products with resin or other coating materials
 - [g] Use of our Products without cleaning residue of flux (even if you use no-clean type fluxes, cleaning residue of flux is recommended); or Washing our Products by using water or water-soluble cleaning agents for cleaning residue after soldering
 - [h] Use of the Products in places subject to dew condensation
4. The Products are not subject to radiation-proof design.
5. Please verify and confirm characteristics of the final or mounted products in using the Products.
6. In particular, if a transient load (a large amount of load applied in a short period of time, such as pulse. is applied, confirmation of performance characteristics after on-board mounting is strongly recommended. Avoid applying power exceeding normal rated power; exceeding the power rating under steady-state loading condition may negatively affect product performance and reliability.
7. De-rate Power Dissipation (Pd) depending on Ambient temperature (Ta). When used in sealed area, confirm the actual ambient temperature.
8. Confirm that operation temperature is within the specified range described in the product specification.
9. ROHM shall not be in any way responsible or liable for failure induced under deviant condition from what is defined in this document.

Precaution for Mounting / Circuit board design

1. When a highly active halogenous (chlorine, bromine, etc.) flux is used, the residue of flux may negatively affect product performance and reliability.
2. In principle, the reflow soldering method must be used on a surface-mount products, the flow soldering method must be used on a through hole mount products. If the flow soldering method is preferred on a surface-mount products, please consult with the ROHM representative in advance.

For details, please refer to ROHM Mounting specification

Precautions Regarding Application Examples and External Circuits

1. If change is made to the constant of an external circuit, please allow a sufficient margin considering variations of the characteristics of the Products and external components, including transient characteristics, as well as static characteristics.
2. You agree that application notes, reference designs, and associated data and information contained in this document are presented only as guidance for Products use. Therefore, in case you use such information, you are solely responsible for it and you must exercise your own independent verification and judgment in the use of such information contained in this document. ROHM shall not be in any way responsible or liable for any damages, expenses or losses incurred by you or third parties arising from the use of such information.

Precaution for Electrostatic

This Product is electrostatic sensitive product, which may be damaged due to electrostatic discharge. Please take proper caution in your manufacturing process and storage so that voltage exceeding the Products maximum rating will not be applied to Products. Please take special care under dry condition (e.g. Grounding of human body / equipment / solder iron, isolation from charged objects, setting of ionizer, friction prevention and temperature / humidity control).

Precaution for Storage / Transportation

1. Product performance and soldered connections may deteriorate if the Products are stored in the places where:
 - [a] the Products are exposed to sea winds or corrosive gases, including Cl₂, H₂S, NH₃, SO₂, and NO₂
 - [b] the temperature or humidity exceeds those recommended by ROHM
 - [c] the Products are exposed to direct sunshine or condensation
 - [d] the Products are exposed to high Electrostatic
2. Even under ROHM recommended storage condition, solderability of products out of recommended storage time period may be degraded. It is strongly recommended to confirm solderability before using Products of which storage time is exceeding the recommended storage time period.
3. Store / transport cartons in the correct direction, which is indicated on a carton with a symbol. Otherwise bent leads may occur due to excessive stress applied when dropping of a carton.
4. Use Products within the specified time after opening a humidity barrier bag. Baking is required before using Products of which storage time is exceeding the recommended storage time period.

Precaution for Product Label

QR code printed on ROHM Products label is for ROHM's internal use only.

Precaution for Disposition

When disposing Products please dispose them properly using an authorized industry waste company.

Precaution for Foreign Exchange and Foreign Trade act

Since our Products might fall under controlled goods prescribed by the applicable foreign exchange and foreign trade act, please consult with ROHM representative in case of export.

Precaution Regarding Intellectual Property Rights

1. All information and data including but not limited to application example contained in this document is for reference only. ROHM does not warrant that foregoing information or data will not infringe any intellectual property rights or any other rights of any third party regarding such information or data. ROHM shall not be in any way responsible or liable for infringement of any intellectual property rights or other damages arising from use of such information or data.:
2. No license, expressly or implied, is granted hereby under any intellectual property rights or other rights of ROHM or any third parties with respect to the information contained in this document.

Other Precaution

1. This document may not be reprinted or reproduced, in whole or in part, without prior written consent of ROHM.
2. The Products may not be disassembled, converted, modified, reproduced or otherwise changed without prior written consent of ROHM.
3. In no event shall you use in any way whatsoever the Products and the related technical information contained in the Products or this document for any military purposes, including but not limited to, the development of mass-destruction weapons.
4. The proper names of companies or products described in this document are trademarks or registered trademarks of ROHM, its affiliated companies or third parties.

General Precaution

1. Before you use our Products, you are requested to carefully read this document and fully understand its contents. ROHM shall not be in any way responsible or liable for failure, malfunction or accident arising from the use of any ROHM's Products against warning, caution or note contained in this document.
2. All information contained in this document is current as of the issuing date and subject to change without any prior notice. Before purchasing or using ROHM's Products, please confirm the latest information with a ROHM sales representative.
3. The information contained in this document is provided on an "as is" basis and ROHM does not warrant that all information contained in this document is accurate and/or error-free. ROHM shall not be in any way responsible or liable for any damages, expenses or losses incurred by you or third parties resulting from inaccuracy or errors of or concerning such information.