



Chipsmall Limited consists of a professional team with an average of over 10 year of expertise in the distribution of electronic components. Based in Hongkong, we have already established firm and mutual-benefit business relationships with customers from,Europe,America and south Asia,supplying obsolete and hard-to-find components to meet their specific needs.

With the principle of “Quality Parts,Customers Priority,Honest Operation,and Considerate Service”,our business mainly focus on the distribution of electronic components. Line cards we deal with include Microchip,ALPS,ROHM,Xilinx,Pulse,ON,Everlight and Freescale. Main products comprise IC,Modules,Potentiometer,IC Socket,Relay,Connector.Our parts cover such applications as commercial,industrial, and automotives areas.

We are looking forward to setting up business relationship with you and hope to provide you with the best service and solution. Let us make a better world for our industry!



## Contact us

Tel: +86-755-8981 8866 Fax: +86-755-8427 6832

Email & Skype: info@chipsmall.com Web: www.chipsmall.com

Address: A1208, Overseas Decoration Building, #122 Zhenhua RD., Futian, Shenzhen, China



## System Power Supply for TV Series

# FET Controller Type 3ch System Power Supply ICs



BD8627EFV

No.09034EAT05

## ●Description

BD8627EFV has realized the high performance and reliability required as a power supply for thin-screen TV. With built-in FET 1ch current mode control, the DC/DC Converter series has the advantage of high-speed load response and wide phase margin.

Due to the high-speed load response, it is most suitable for TV-purpose processors with increasingly high performance, and due to the wide phase margin it leaves a good margin for board pattern & constant setting and so facilitates its application design.

As a high-reliability design, it has various built-in protection circuits (overcurrent protection, output voltage abnormal protection, thermal protection, and off-latch function at the time of abnormality etc.), therefore as an advantage it does not easily damage in every possible abnormal condition such as all-pin short circuit test etc. and hence most suitable for thin-screen TV which requires the high reliability.

## ●Features

- 1) High efficiency in all load area
- 2) 3.0A output current
- 3) Low RDS(ON) internal switches (PchMOS:85mΩ, NchMOS:65mΩ)
- 4) ±1% reference voltage accuracy
- 5) Programmable frequency : 250kHz-1MHz
- 6) Terminal RT OPEN/SHORT detecting function
- 7) Over current protection function
- 8) Output over voltage/low voltage protection function (over : FB > VREF +60mV , low : FB < VREF -60mV)
- 9) Timer off latch function in abnormal circumstances
- 10) Thermal shutdown function
- 11) Under voltage protection
- 12) Soft start/start delay circuit
- 13) Soft start time out function
- 14) HTSSOP-B20 package

● ABSOLUTE MAXIMUM RATING (Ta=25°C)

Parameter	Symbol	Limits	Unit
Input supply voltage	$V_{IN}$	7	V
Input terminal voltage	$V_{INP}^{*1}$	$V_{IN}$	V
Output terminal voltage	$V_{OUT}^{*2}$	$V_{IN}$	V
Output current	$I_{OUT}$	4	A
Power dissipation	Pd	3.2 <sup>*3</sup>	W
Operating temperature	Topr	-10 ~ 85	°C
Storage temperature	Tstg	-55 ~ 150	°C

\* 1  $V_{INP}$  Application terminal : EN, SS/DELAY, TEST, FB

\* 2  $V_{OUT}$  Application terminal : SW, PDET, FC, RT, REG

\* 3 (70mm x 70mm, thickness 1.6mm, and four layer glass epoxy substrates)

When mounting substrate and the package back exposure part are connected with solder.

Operating at higher than Ta=25°C, 25.6mW shall be reduced per 1

Operation condition

Parameter	Symbol	MIN	TYP	MAX	Unit
Input supply voltage	$V_{IN}$	4.5	-	6.0	V
Output current	$I_{OUT}$	-	-	3.0	A

### ● Electrical characteristic

(Unless otherwise noted  $T_a=25^{\circ}\text{C}$ ,  $V_{\text{IN}}=5.6\text{V}$ )

Parameter	Symbol	Specification value			UNIT	Condition
		MIN	TYP	MAX		
VIN supply current (operating)	$I_{\text{Q active}}$	-	1.3	2.0	mA	$V_{\text{FB}} = 0.83\text{V}$ , $V_{\text{FC}} = 1\text{V}$
VIN supply current (standby)	$I_{\text{Q stby}}$	-	350	700	$\mu\text{A}$	$V_{\text{EN}} = 0\text{V}$
Reference voltage (VREF)	$V_{\text{REF}}$	0.792	0.8	0.808	V	
Output rise detection voltage	$V_{\text{OVP}}$	30	60	90	mV	Monitoring FB terminal
Output decrease detection voltage	$V_{\text{LVP}}$	-90	-60	-30	mV	Monitoring FB terminal
Terminal PDET output current	$I_{\text{PDET}}$	1	-	-	mA	$V_{\text{PDET}} < 0.5\text{V}$
Oscillation frequency	$f_{\text{OSC}}$	500	550	600	kHz	$R_{\text{OSC}} = 220\text{k}\Omega$
Pch FET ON resistance	$R_{\text{PFET}}$	-	85	120	$\text{m}\Omega$	$I_{\text{SW}} = 1\text{A}$
Nch FET ON resistance	$R_{\text{NFET}}$	-	65	100	$\text{m}\Omega$	$I_{\text{SW}} = -1\text{A}$
UVLO voltage	$V_{\text{UVLO}}$	3.8	4.0	4.2	V	
SW leak current	$I_{\text{LSW}}$	-	0	1	$\mu\text{A}$	$V_{\text{EN}} = 0\text{V}$ , $V_{\text{IN}} = 6\text{V}$
EN terminal H threshold voltage	$V_{\text{ENH}}$	2.0	-	-	V	
EN terminal L threshold voltage	$V_{\text{ENL}}$	-	-	0.5	V	
SS/DELAY terminal source current	$I_{\text{SSSO}}$	2	4	6	$\mu\text{A}$	

$V_{\text{FB}}$ :FB terminal voltage,  $V_{\text{EN}}$ :EN terminal voltage,  $V_{\text{FC}}$ :FC terminal voltage,  $V_{\text{PDET}}$ : PDET terminal voltage  
Current capability should not exceed Pd.

### Permissible loss

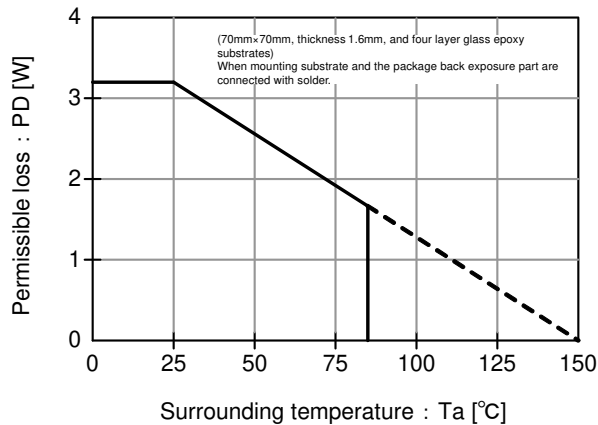

Fig. 1 heat decrease curve



● Block Diagram

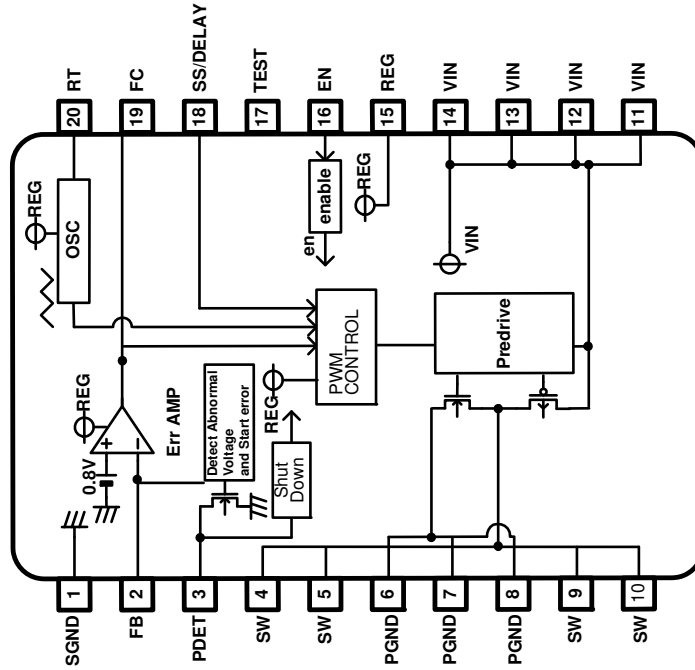

Fig.2 Block diagram

● Pin description

No.	Symbol	Description	Explanation
1	SGND	Signal GND terminal	Small signal system GND
2	FB	Feed back terminal	Output voltage detection
3	PDET	Off latch signal output	Reset output
4	SW	Output terminal	Switching output
5	SW		
6	PGND	Power GND terminal	GND for power MOSFET
7	PGND		
8	PGND		
9	SW	Output terminal	Power Mos output
10	SW		
11	VIN	Power supply input terminal	Power supply input. The decoupling is done to PGND
12	VIN		
13	VIN		
14	VIN		
15	REG	Internal regulator	Internal regulator
16	EN	Enable input	ON/OFF control for device operation
17	TEST	TEST terminal	GND short in application set
18	SS/DELAY	Soft start adjustment capacity connection terminal	The soft start time is adjusted with the connected capacitor
19	FC	Error amplifier output	Error amplifier phase compensation point
20	RT	Frequency adjustment resistance connection terminal	The switching frequency is set by the connected resistance

●Pin equivalence circuit diagram

No.	Symbol	Explanation	Terminal equivalent circuit diagram
1	SGND	GND (connected 0V)	
2	FB	Output voltage detection terminal	
3	PDET	Off latch signal output terminal	
4,5,9,10	SW	Output terminal	
6,7,8	PGND	Power GND (Same voltage as SGND)	
11,12,13,14	VIN	Power supply input terminal	

No.	Symbol	Explanation	Terminal equivalent circuit diagram
15	REG	Internal regulator output terminal	
16	EN	Enable terminal	

No.	Symbol	Explanation	Terminal equivalent circuit diagram
18	SS	Soft start time adjustment terminal	
19	FC	Error amplifier compensation terminal	
20	RT	Oscillator frequency adjustment terminal	



● **Operation description**

**Enable control**

The device can be controlled ON/OFF by EN terminal (16 pin) voltage.  
An internal circuit starts when VEN reaches 0.65V.

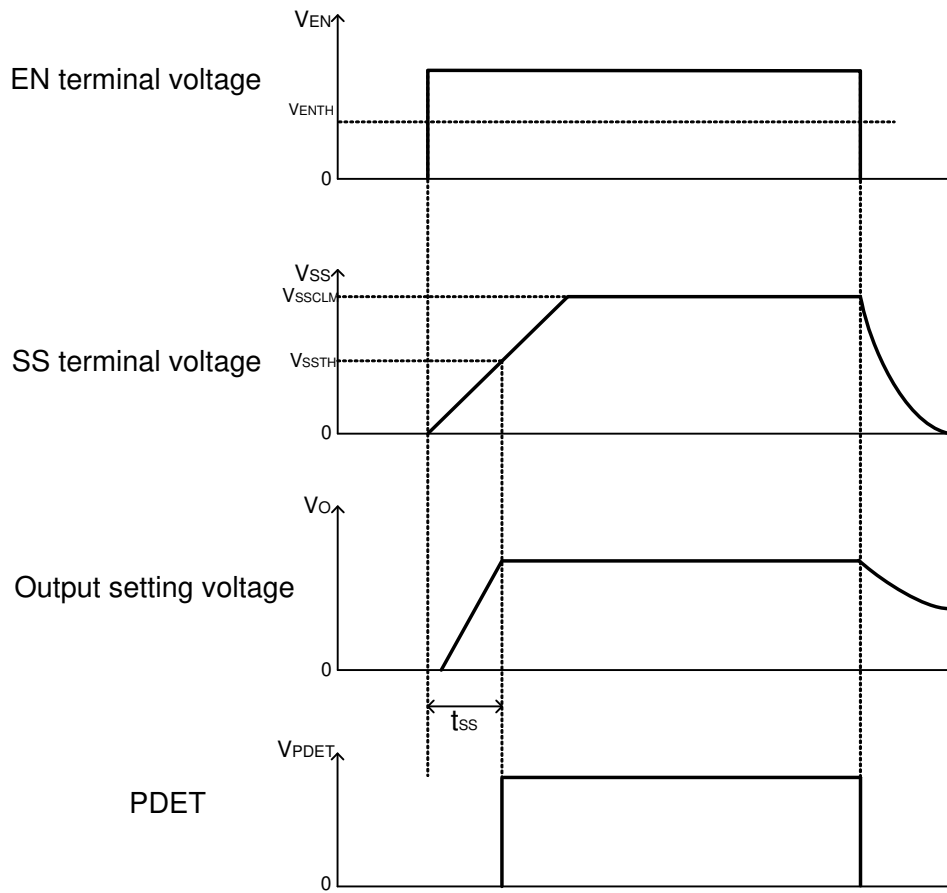

**Fig.3 ON/OFF transition wave form in EN controlling**

**Soft start time set function**

As for BD8627EFV, output can do soft start without overshoot by charging soft start capacity (CSS) connected between SS and SGND terminal.

Also, soft start time (tss) can be set by setting soft start capacity (CSS) arbitrarily.

**OSC oscillation frequency setting function**

The output oscillation frequency can be set by connecting resistance between terminal RT (20 pins) and SGND (range = 250kHz - 1MHz)

The relation between RT terminal resistance and the oscillation frequency follows Fig.4.

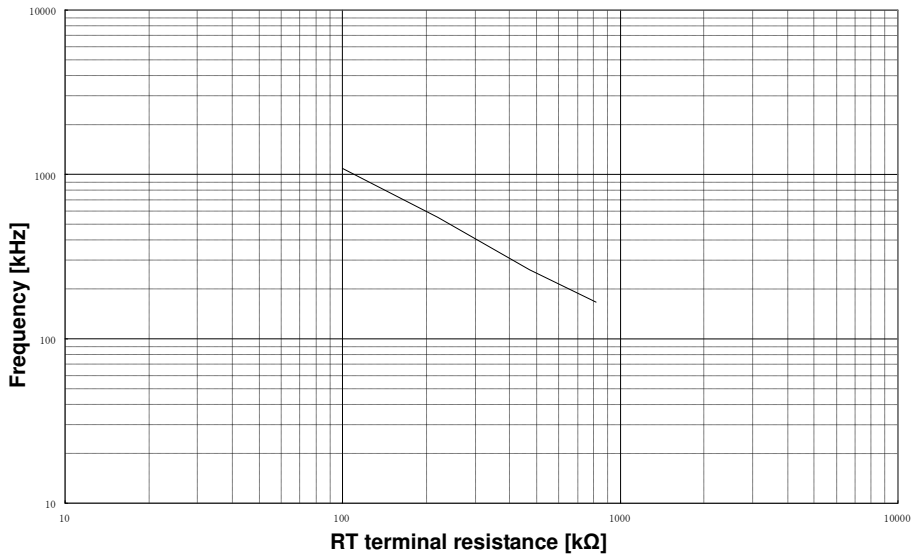

**Fig. 4 RT resistance-oscillation frequency**

● **Protection function**

Protection circuit is effective for destruction prevention due to accident so that avoid using under continuous protection operation.

**Low voltage protection function (LVP)**

The voltage of the terminal FB (2 pins) is compared with internal reference voltage VREF.

If FB terminal voltage falls below  $V_{LVP}(= VREF - 60mV)$  and the state continues for 500us, output changes to low voltage and the state is fixed. In that case, PDET (3pin) output changes to L.

Table 1 output low voltage protection function

EN terminal	SS terminal	FB terminal	Low voltage protection function	Low voltage protection operation
$>V_{IHEN}$	$>1.4V(typ)$	$<V_{LVP}$	Effective	ON
		$>V_{LVP}$		OFF
	$<1.4V(typ)$	-	Invalidity	OFF
$<V_{ILEN}$	-	-	Invalidity	OFF

\* Low voltage protection function is available when SS terminal voltage becomes more than 1.4V (typ) in the transition to ON control (during soft start).

**Over voltage protection function(OVP)**

The voltage of the terminal FB is compared with internal reference voltage VREF.

If FB terminal voltage is over  $V_{ovp}(=VREF + 60mV)$  and the state is continues for 500usec, output changes to low voltage and the state is fixed.

Table 2 output over voltage protection function

EN terminal	SS terminal	FB terminal	Over voltage protection function	Over voltage protection operation
$>V_{IHEN}$	$>1.4V(typ)$	$>V_{OVP}$	Effective	ON
		$<V_{OVP}$		OFF
	$<1.4V(typ)$	-	Invalidity	OFF
$<V_{ILEN}$	-	-	Invalidity	OFF

\* Over voltage protection function is available when SS terminal voltage becomes more than 1.4V (typ) in the transition to ON control (during soft start).

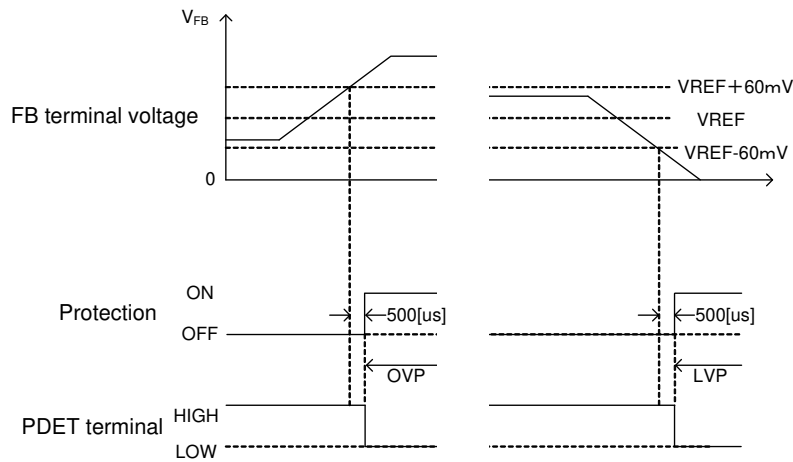

Fig. 5 Output voltage error detection range

**Under voltage lock out protection (UVLO)**

As for BD8627EFV, the power-supply voltage decrease detection protection circuit is built in. If the input voltage decrease below the UVLO voltage (4.0V typ), the device state changes to the standby mode (Moreover, to prevent the chattering of the output) hysteresis width of 300mV(typ) has been installed in the UVLO cancel voltage.

**RT terminal open/short protection function (RTO/RTS)**

RT terminal opening/short protection function prevent the clock from abnormal oscillation. If RT terminal open/short protection function is detected, output voltage changes to low level and is fixed.

Terminal RT opening/short protection function is always effective after the power supply start-up. Terminal RT opening/short protection function is available if the state continue for 500usec, abnormal detection operates when the state continues about 500µsec(typ).

**Soft start time-out function**

If VSS doesn't exceed VSSTH within 64msec (typ) since a soft start began, BD8627EFV controls an off latch. Vo is fixed in a low level.

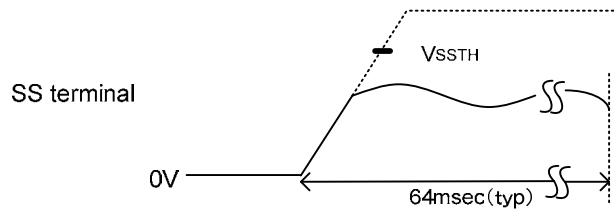

Fig. 6 Soft start time-out

**Error detection (off latch) release method**

BD8627EFV enters the state of an off latch when the protection function operates. To release the off latch state, EN terminal voltage should be changed to low level once time.

**Thermal shut down function**

Thermal shut down circuit (TSD circuit) is built into BD8627EFV. When the temperature of the chip exceeds  $T_{jmax}=175$ , the DC/DC converter is fixed in a low voltage.

TSD function is aimed to shut down IC from thermal reckless driving under an abnormal state to exceed  $T_{jmax}=175$ . It aims at neither protection nor the guarantee of the set. Therefore, please do not use this function to protect the set.

**Over current protection function**

The over current protection function has been achieved by limiting the current that flows on high side MOSFET. The current is controlled in every one cycle of the switching frequency. When an abnormal state continues for about 500µsec(typ), the output is fixed in a low level.

●Ordering part number

B	D
---	---

Part No

8	6	2	7
---	---	---	---

Part No.

E	F	V
---	---	---

Package  
EFV: HTSSOP-B24

E	2
---	---

Packaging and forming specification  
E2: Embossed tape and reel

HTSSOP-B20

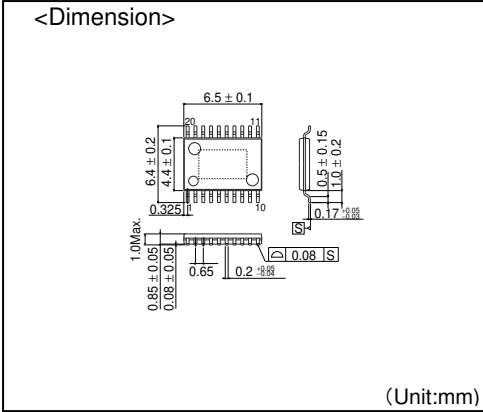

<Tape and Reel information>

Tape	Embossed carrier tape
Quantity	2500pcs
Direction of feed	E2 (The direction is the 1 pin of product is at the upper left when you hold reel on the left hand and you pull out the tape on the right hand)

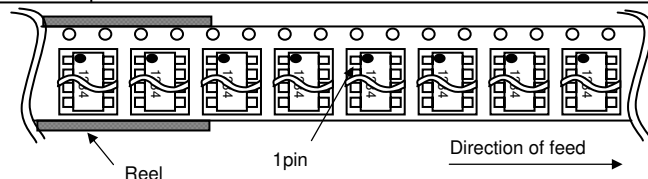

※When you order , please order in times the amount of package quantity.

## Notes

No copying or reproduction of this document, in part or in whole, is permitted without the consent of ROHM Co.,Ltd.

The content specified herein is subject to change for improvement without notice.

The content specified herein is for the purpose of introducing ROHM's products (hereinafter "Products"). If you wish to use any such Product, please be sure to refer to the specifications, which can be obtained from ROHM upon request.

Examples of application circuits, circuit constants and any other information contained herein illustrate the standard usage and operations of the Products. The peripheral conditions must be taken into account when designing circuits for mass production.

Great care was taken in ensuring the accuracy of the information specified in this document. However, should you incur any damage arising from any inaccuracy or misprint of such information, ROHM shall bear no responsibility for such damage.

The technical information specified herein is intended only to show the typical functions of and examples of application circuits for the Products. ROHM does not grant you, explicitly or implicitly, any license to use or exercise intellectual property or other rights held by ROHM and other parties. ROHM shall bear no responsibility whatsoever for any dispute arising from the use of such technical information.

The Products specified in this document are intended to be used with general-use electronic equipment or devices (such as audio visual equipment, office-automation equipment, communication devices, electronic appliances and amusement devices).

The Products specified in this document are not designed to be radiation tolerant.

While ROHM always makes efforts to enhance the quality and reliability of its Products, a Product may fail or malfunction for a variety of reasons.

Please be sure to implement in your equipment using the Products safety measures to guard against the possibility of physical injury, fire or any other damage caused in the event of the failure of any Product, such as derating, redundancy, fire control and fail-safe designs. ROHM shall bear no responsibility whatsoever for your use of any Product outside of the prescribed scope or not in accordance with the instruction manual.

The Products are not designed or manufactured to be used with any equipment, device or system which requires an extremely high level of reliability the failure or malfunction of which may result in a direct threat to human life or create a risk of human injury (such as a medical instrument, transportation equipment, aerospace machinery, nuclear-reactor controller, fuel-controller or other safety device). ROHM shall bear no responsibility in any way for use of any of the Products for the above special purposes. If a Product is intended to be used for any such special purpose, please contact a ROHM sales representative before purchasing.

If you intend to export or ship overseas any Product or technology specified herein that may be controlled under the Foreign Exchange and the Foreign Trade Law, you will be required to obtain a license or permit under the Law.



Thank you for your accessing to ROHM product informations.  
More detail product informations and catalogs are available, please contact us.

## ROHM Customer Support System

<http://www.rohm.com/contact/>