



Chipsmall Limited consists of a professional team with an average of over 10 year of expertise in the distribution of electronic components. Based in Hongkong, we have already established firm and mutual-benefit business relationships with customers from,Europe,America and south Asia,supplying obsolete and hard-to-find components to meet their specific needs.

With the principle of “Quality Parts,Customers Priority,Honest Operation,and Considerate Service”,our business mainly focus on the distribution of electronic components. Line cards we deal with include Microchip,ALPS,ROHM,Xilinx,Pulse,ON,Everlight and Freescale. Main products comprise IC,Modules,Potentiometer,IC Socket,Relay,Connector.Our parts cover such applications as commercial,industrial, and automotives areas.

We are looking forward to setting up business relationship with you and hope to provide you with the best service and solution. Let us make a better world for our industry!



Contact us

Tel: +86-755-8981 8866 Fax: +86-755-8427 6832

Email & Skype: info@chipsmall.com Web: www.chipsmall.com

Address: A1208, Overseas Decoration Building, #122 Zhenhua RD., Futian, Shenzhen, China



Lineup

Articles	Variable	3.3	5.0	8.0	9.0	Package	
BDxxC0AWFP-CE2	○	○	○	○	○	TO252-5	Reel of 2000
BDxxC0AFP-CE2	-	○	○	○	○	TO252-3	Reel of 2000
BDxxC0AWHFP-CTR	○	○	○	○	○	HRP5	Reel of 2000
BDxxC0AHFP-CTR	-	○	○	○	○	HRP5	Reel of 2000
BDxxC0AWFP2-CE2	○	○	○	○	○	TO263-5	Reel of 500
BDxxC0AFP2-CE2	-	○	○	○	○	TO263-3(F)	Reel of 500

Typical Application Circuits

〈Output Voltage Variable Type (With SW)〉

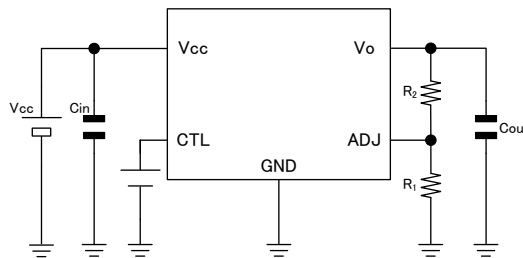

Figure 1. Typical Application Circuit Output Voltage Variable Type (With SW)

〈Output Voltage Fixation Type (With SW)〉

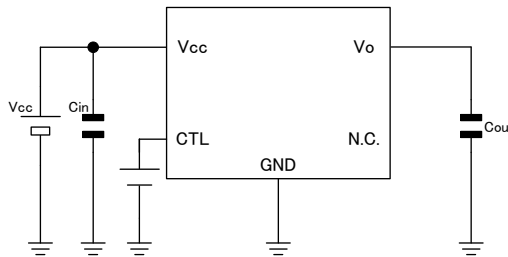

Figure 2. Typical Application Circuit Output Voltage Fixation Type (With SW)

〈Output Voltage Fixation Type (Without SW)〉

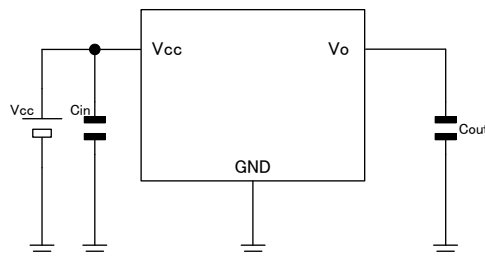

Figure 3. Typical Application Circuit Output Voltage Fixation Type (Without SW)

Pin Configurations/Pin Descriptions

⟨With SW (TO252-5/HRP5/TO263-5)⟩

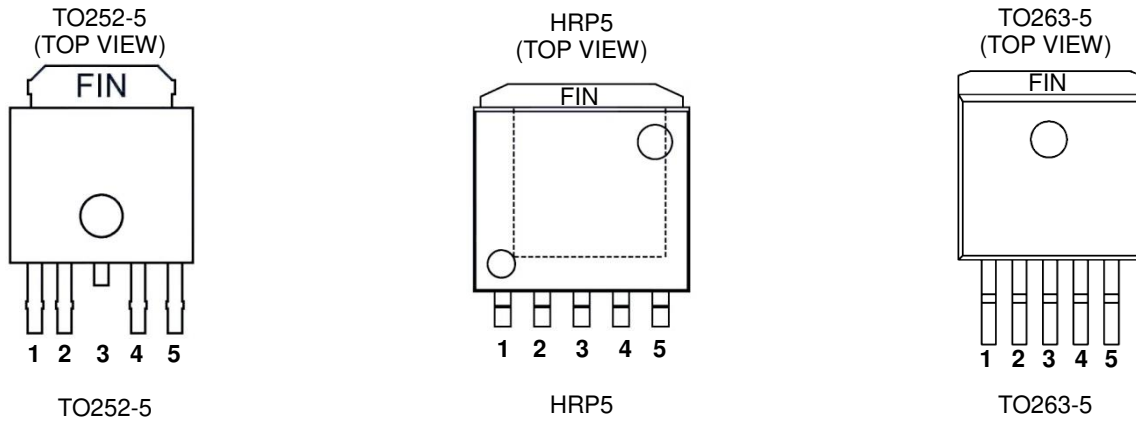

Figure 4. Pin Configurations (With SW)

Pin No.	Pin Name	Function
1	CTL	Output Control Pin
2	Vcc	Power Supply Pin
3	N.C. (Note 1) GND	N.C. Pin (TO252-5) GND (HRP5/TO263-5)
4	Vo	Output Pin
5	ADJ N.C. (Note 1)	Variable Pin (BD00C0AW) N.C. Pin (BD33/50/80/90C0AW)
FIN	GND	GND

(Note 1) N.C.Pin can be open. Because it isn't connect it inside of IC.

⟨Without SW (TO252-3/TO263-3(F))⟩

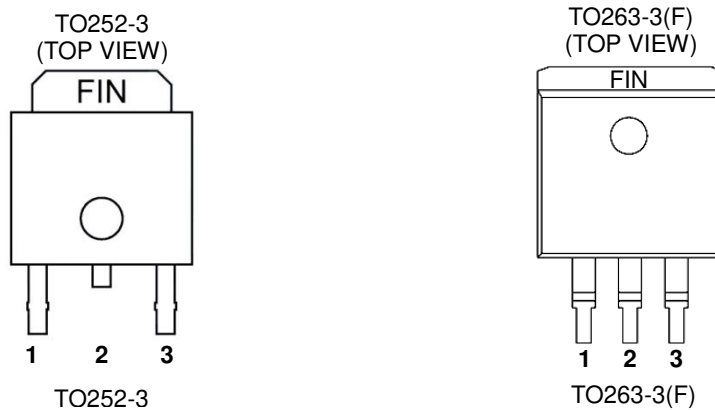

Figure 5. Pin Descriptions (Without SW)

Pin No.	Pin Name	Function
1	Vcc	Power Supply Pin
2	N.C. (Note 1) GND	N.C. Pin (TO252-3) GND (TO263-3(F))
3	Vo	Output Pin
FIN	GND	GND

(Note 1) N.C.Pin can be open. Because it isn't connect it inside of IC.

〈Without SW (HRP5)〉

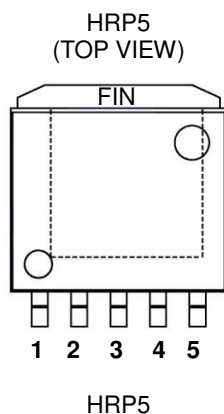

Figure 6. Pin Descriptions (Without SW) (HRP5)

Pin No.	Pin Name	Function
1	Vcc	Power Supply Pin
2	N.C. (Note 1)	N.C. Pin
3	GND	GND
4	N.C.	N.C. Pin
5	Vo	Output Pin
FIN	GND	GND

(Note 1) N.C.Pin can be open. Because it isn't connect it inside of IC.

Block Diagrams

<BD00C0AWFP/WHFP/WFP2-C (Output Voltage Variable Type, With SW) >

■ TO252-5/HRP5/TO263-5

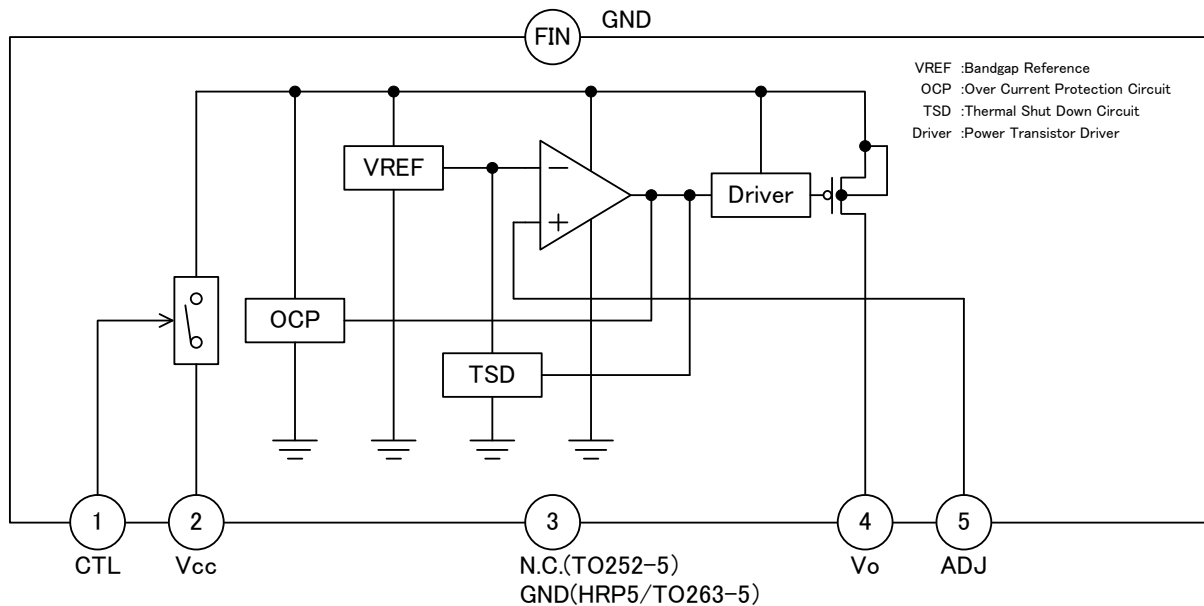

Figure 7. Block diagram
BD00C0AWFP/WHFP/WFP2-C (Output Voltage Variable Type, With SW)

<BDxxC0AWFP/WHFP/WFP2-C (Output Voltage Fixation Type, With SW) >

■ TO252-5/HRP5/TO263-5

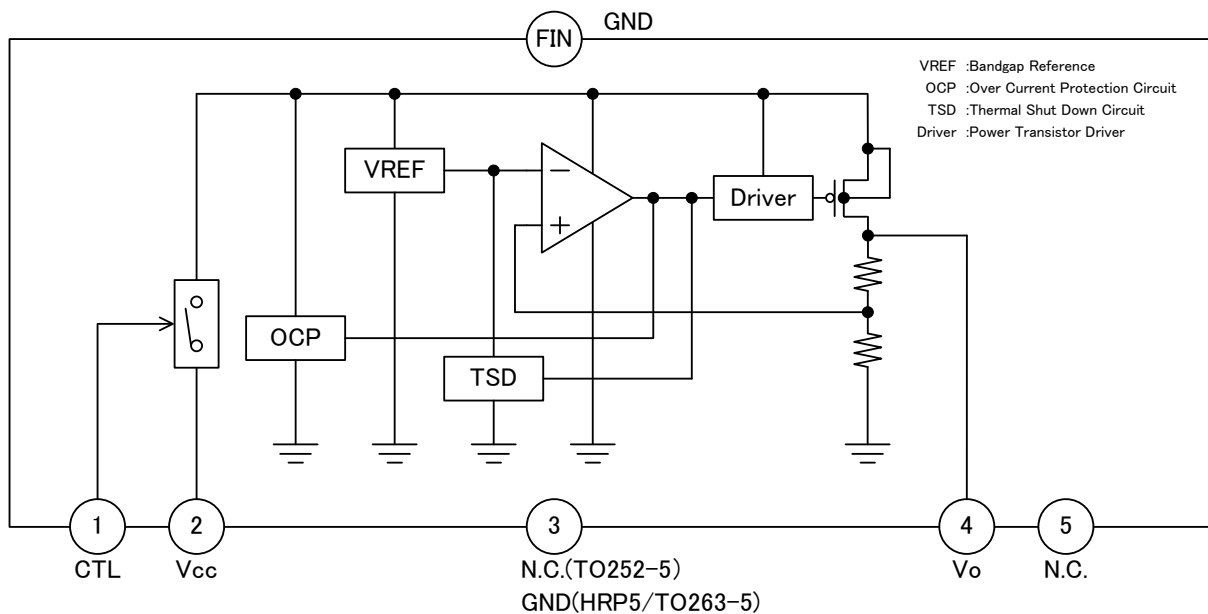

Figure 8. Block diagram
BDxxC0AWFP/WHFP/WFP2-C (Output Voltage Fixation Type, With SW)

<BDxxC0AFP/HFP/FP2-C (Output Voltage Fixation Type, Without SW) >

■ TO252-3/TO263-3(F)

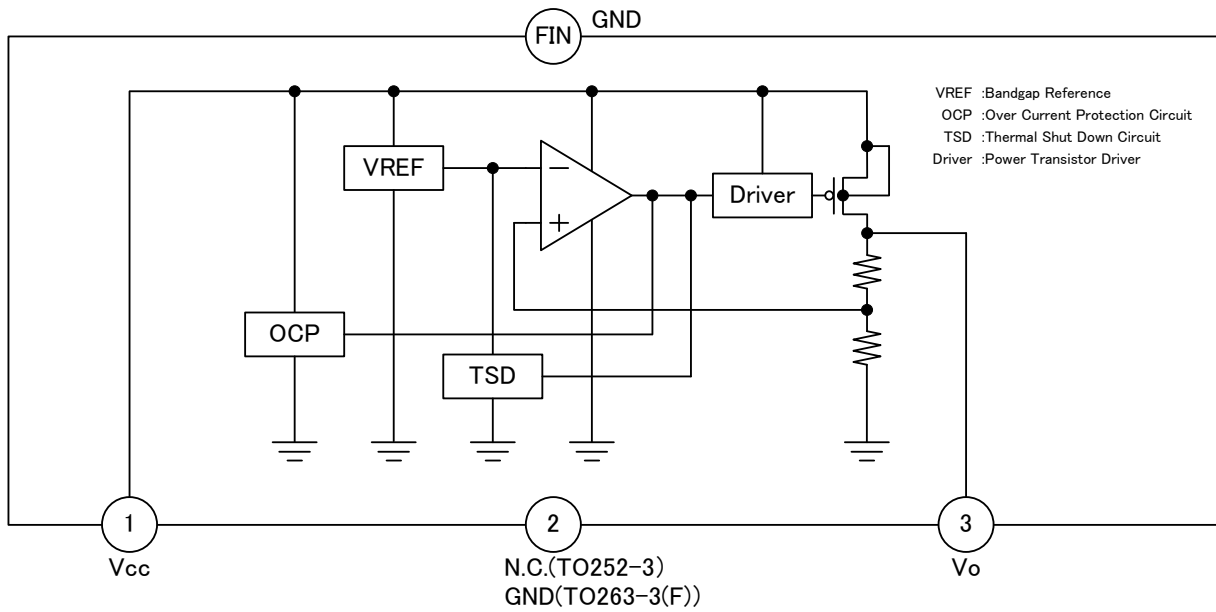

Figure 9. Block diagram
 BDxxC0AFP/FP2-C (Output Voltage Fixation Type, Without SW)

■ HRP5

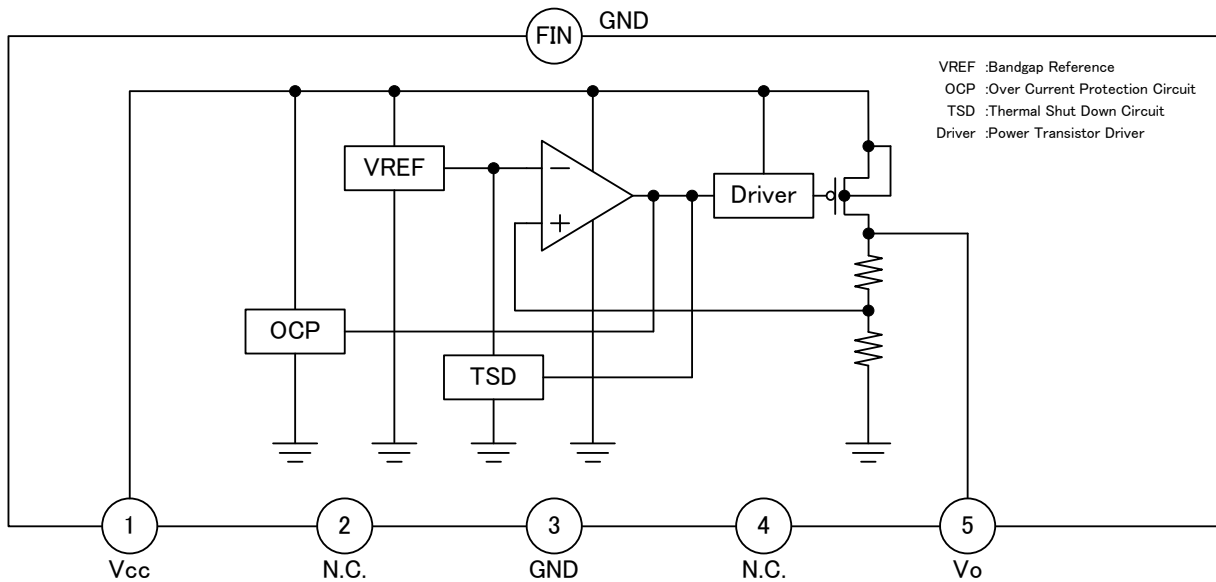

Figure 10. Block diagram
 BDxxC0AHFP-C (Output Voltage Fixation Type, Without SW)

Absolute Maximum Ratings (Ta= 25°C)

Parameter	Symbol	Ratings	Unit
Supply Voltage (Note 1)	Vcc	-0.3 to +35.0	V
Output Control Voltage (With SW) (Note 2)	V _{CTL}	-0.3 to +35.0	V
Operating Temperature Range	T _{opr}	-40 to +125	°C
Storage Temperature Range	T _{stg}	-55 to +150	°C
Maximum Junction Temperature	T _{jmax}	150	°C

(Note 1) Do not exceed Pd (Please refer to Power Dissipation in P.27-29).

(Note 2) The order of starting up power supply (Vcc) and CTL pin doesn't have either in the problem within the range of the operation power-supply voltage ahead.

Caution: Operating the IC over the absolute maximum ratings may damage the IC. The damage can either be a short circuit between pins or an open circuit between pins and the internal circuitry. Therefore, it is important to consider circuit protection measures, such as adding a fuse, in case the IC is operated over the absolute maximum ratings.

Recommended Operating Conditions (-40°C ≤ Ta ≤ +125°C)

Parameter	Symbol	Min	Max.	Unit
Supply Voltage (Vo ≥ 3.0V)	Vcc	Vo+1	26.5	V
Supply Voltage (Vo < 3.0V)	Vcc	4.0	26.5	V
Startup Voltage (Io=0mA)	Vcc	-	3.8	V
Output Control Voltage (With SW)	V _{CTL}	0	26.5	V
Output Current	Io	0	1.0	A
Output Voltage (BD00C0AW) (Note 1)	Vo	1.0	15.0	V

(Note 1) Please refer to Notes15 for use when you use BD00C0AW by output voltage 1.0V ≤ Vo < 3.0V.

Thermal Resistance (Note 1)

Parameter	Symbol	Thermal Resistance (Typ)		Unit
		1s (Note 3)	2s2p (Note 4)	
TO252-3, TO252-5				
Junction to Ambient	θ _{JA}	136	23	°C/W
Junction to Top Characterization Parameter (Note 2)	Ψ _{JT}	17	3	°C/W
HRP5				
Junction to Ambient	θ _{JA}	120	22	°C/W
Junction to Top Characterization Parameter (Note 2)	Ψ _{JT}	8	3	°C/W
TO263-3(F), TO263-5				
Junction to Ambient	θ _{JA}	81	21	°C/W
Junction to Top Characterization Parameter (Note 2)	Ψ _{JT}	8	2	°C/W

(Note 1) Based on JESD51-2A (Still-Air)

(Note 2) The thermal characterization parameter to report the difference between junction temperature and the temperature at the top center of the outside surface of the component package.

(Note 3) Using a PCB board based on JESD51-3.

Layer Number of Measurement Board	Material	Board Size
Single	FR-4	114.3mm x 76.2mm x 1.57mm

Top	
Copper Pattern	Thickness
Footprints and Traces	70μm

(Note 4) Using a PCB board based on JESD51-5, 7.

Layer Number of Measurement Board	Material	Board Size	Thermal Via (Note 5)	
			Pitch	Diameter
4 Layers	FR-4	114.3mm x 76.2mm x 1.6mm	1.20mm	Φ0.30mm

Top		2 Internal Layers		Bottom	
Copper Pattern	Thickness	Copper Pattern	Thickness	Copper Pattern	Thickness
Footprints and Traces	70μm	74.2mm x 74.2mm	35μm	74.2mm x 74.2mm	70μm

(Note 5) This thermal via connects with the copper pattern of all layers. The placement and dimensions obey a land pattern.

Electrical Characteristics

Unless otherwise specified, $-40^{\circ}\text{C} \leq T_a \leq +125^{\circ}\text{C}$, $V_{CC}=13.5\text{V}$, $I_o=0\text{mA}$, $V_{CTL}=5.0\text{V}$ (With SW)

The resistor of between ADJ and $V_o = 56.7\text{k}\Omega$, ADJ and GND = $10\text{k}\Omega$ (BD00C0AW)

Parameter	Symbol	Guaranteed Limit			Unit	Conditions
		Min.	Typ.	Max.		
Shutdown Current (With SW)	I _{sd}	-	0	5	μA	V _{CTL} =0V
Circuit Current	I _b	-	0.5	2.5	mA	
ADJ Terminal Voltage (BD00C0AWFP/WHFP)	V _{ADJ}	0.742	0.750	0.758	V	I _o =50mA, T _a =25°C
ADJ Terminal Voltage (BD00C0AW)	V _{ADJ}	0.727	0.750	0.773	V	I _o =50mA
Output Voltage (BD33/50C0A(W9FP/(W)HFP)	V _o	V _o ×0.99	V _o	V _o ×1.01	V	I _o =200mA, T _a =25°C
Output Voltage (BD33/50C0A(W))	V _o	V _o ×0.97	V _o	V _o ×1.03	V	I _o =200mA
Output Voltage (BD80/90C0A(W)FP/(W)HFP)	V _o	V _o ×0.99	V _o	V _o ×1.01	V	I _o =500mA, T _a =25°C
Output Voltage (BD80/90C0A(W))	V _o	V _o ×0.97	V _o	V _o ×1.03	V	I _o =500mA
Dropout Voltage (BD00/50/80/90C0A(W))	ΔV _d	-	0.3	0.5	V	V _{CC} =V _o ×0.95, I _o =500mA
Ripple Rejection (BD00/33/50C0A(W))	R.R.	45	55	-	dB	f=120Hz, Input Voltage Ripple =1V _{rms} , I _o =100mA
Ripple Rejection (BD80/90C0A(W))	R.R.	40	50	-	dB	f=120Hz, Input Voltage Ripple =1V _{rms} , I _o =100mA
Line Regulation	Reg.I	-	20	80	mV	V _o +1.0V ≤ V _{CC} ≤ 26.5V
Load Regulation	Reg.L	-	$\frac{V_o}{\times 0.010}$	$\frac{V_o}{\times 0.020}$	V	5mA ≤ I _o ≤ 1A
CTL ON Mode Voltage (With SW)	V _{thH}	2.0	—	—	V	ACTIVE MODE
CTL OFF Mode Voltage (With SW)	V _{thL}	—	—	0.8	V	OFF MODE
CTL Bias Current (With SW)	I _{CTL}	—	25	50	μA	

Reference Data

■ BD00C0AW-C series (Vo=5.0V)

Unless otherwise specified, $-40^{\circ}\text{C} \leq T_a \leq +125^{\circ}\text{C}$, $V_{CC}=13.5\text{V}$, $V_{CTL}=5.0\text{V}$, $I_o=0\text{mA}$, $V_o=5.0\text{V}$
 (The resistor of between ADJ and Vo =56.7kΩ, ADJ and GND =10kΩ)

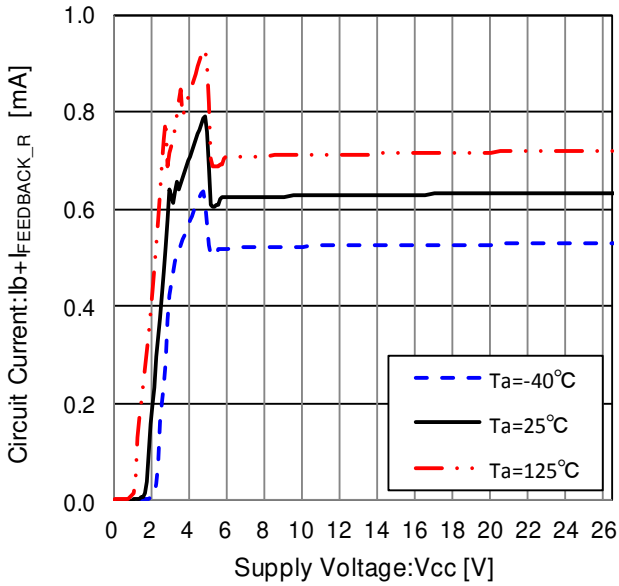

Figure 11. Circuit Current
 (IFEEDBACK_R(Note 1) ≈ 75μA)
 (Note 1) IFEEDBACK_R is the current flowing into external feedback resistance.

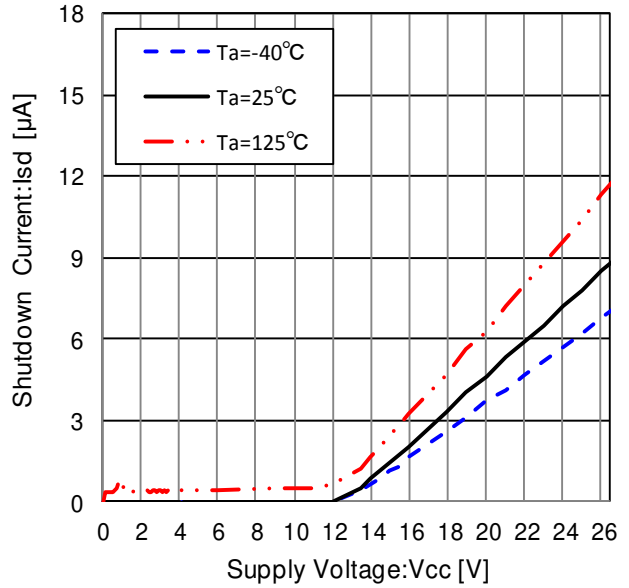

Figure 12. Shutdown Current
 (VCTL=0V)

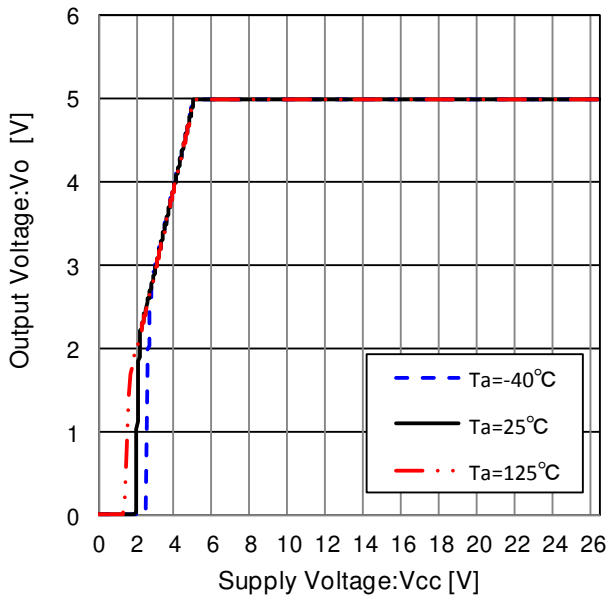

Figure 13. Line Regulation
 (Io=0mA)

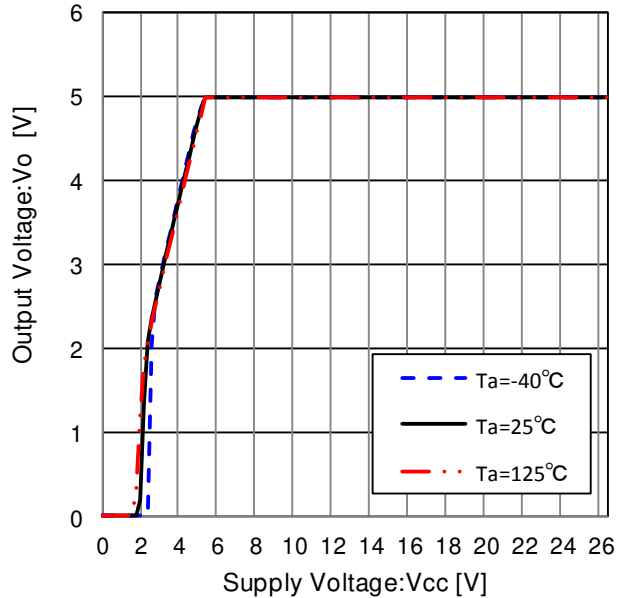

Figure 14. Line Regulation
 (Io=500mA)

Reference Data - continued

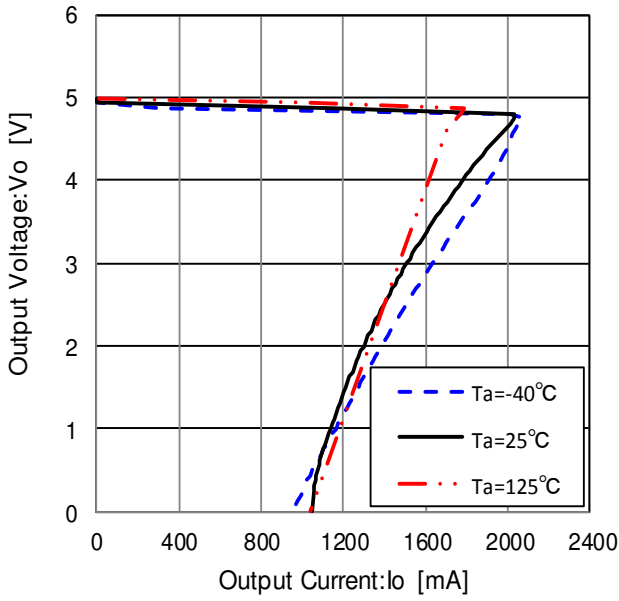

Figure 15. Load Regulation

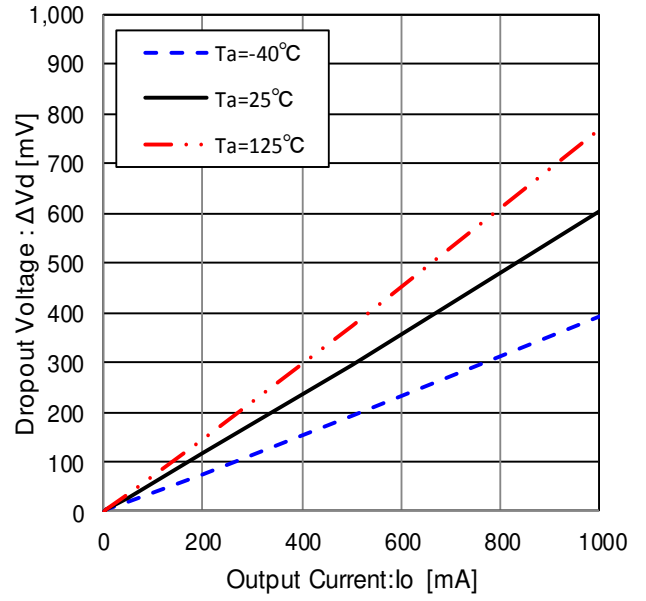

Figure 16. Dropout Voltage
(Vcc=Vo×0.95=4.75V)

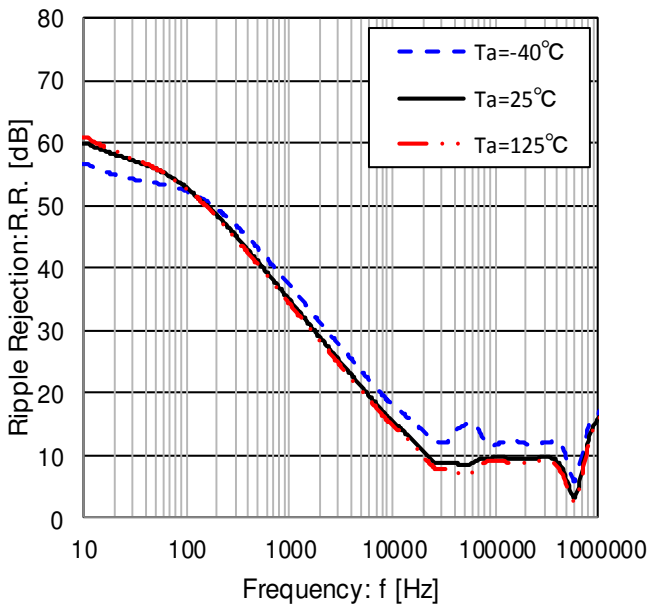

Figure 17. Ripple Rejection
(Io=100mA)

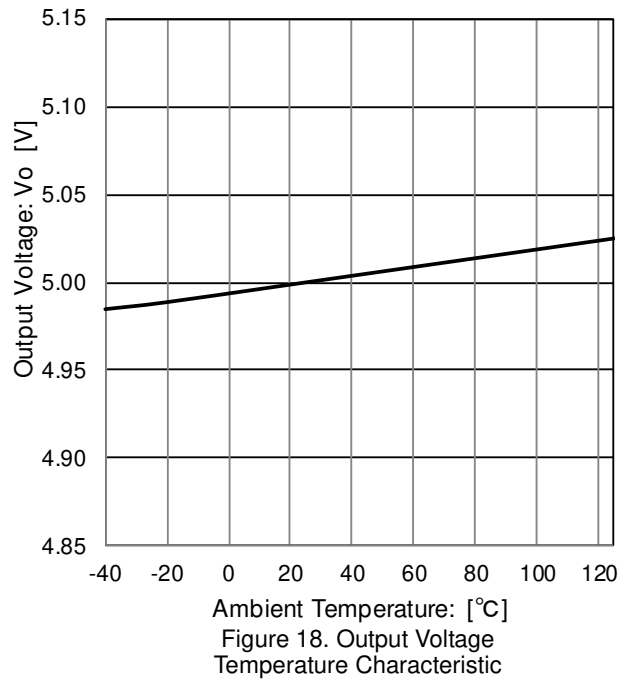

Figure 18. Output Voltage
Temperature Characteristic

Reference Data - continued

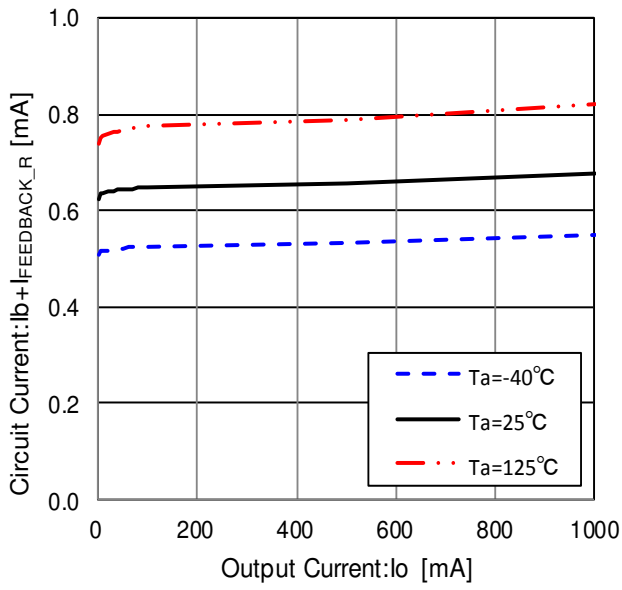

Figure 19. Circuit Current
($0\text{mA} \leq I_o \leq 1000\text{mA}$, $I_{FEEDBACK_R} \approx 75\mu\text{A}$)

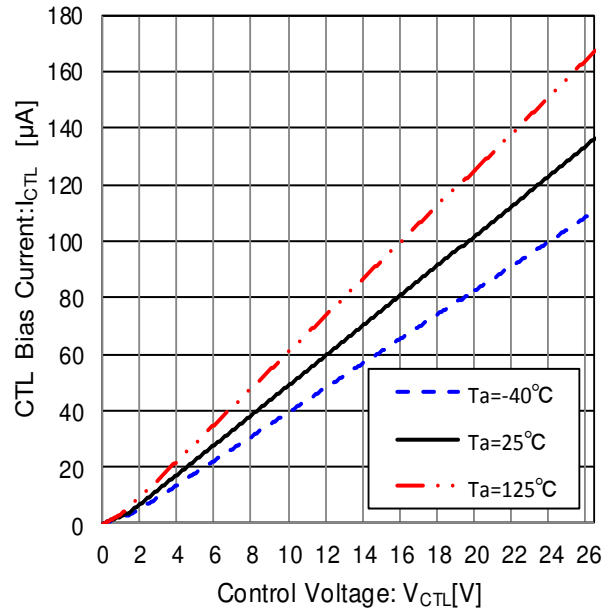

Figure 20. CTL Current vs CTL Voltage

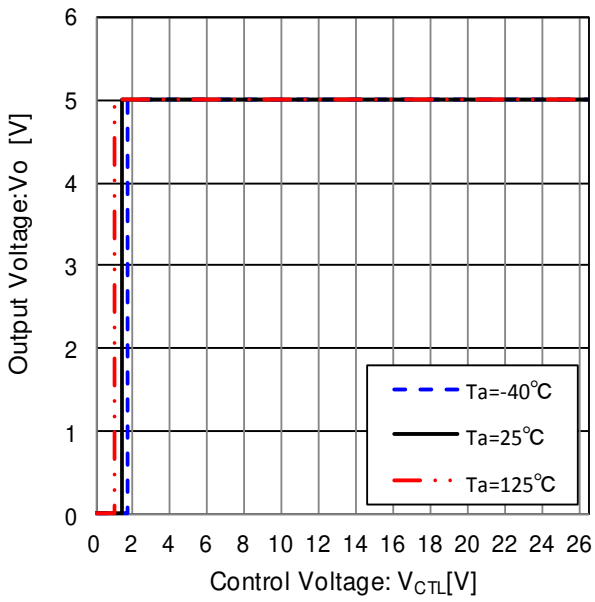

Figure 21. Output Voltage vs CTL Voltage

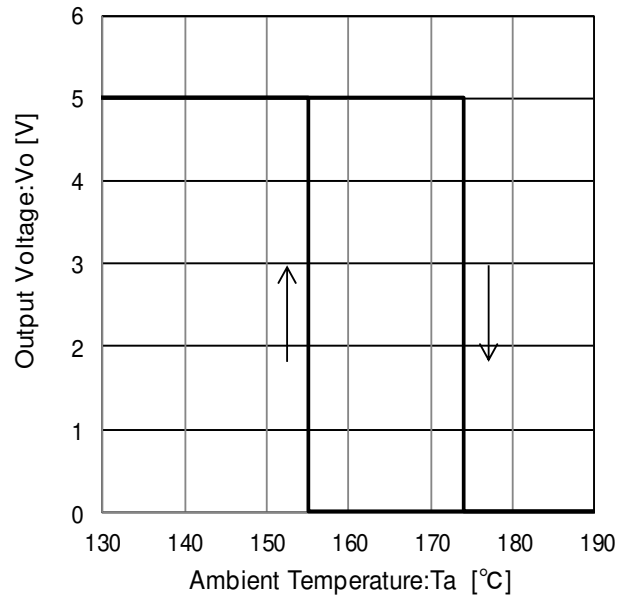
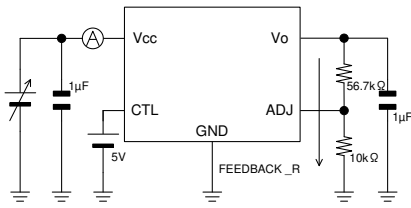

Figure 22. Thermal Shutdown
Circuit Characteristic

Measurement setup for reference data

■ BD00C0AW-C series (Vo=5.0V)



Measurement setup for Figure 11

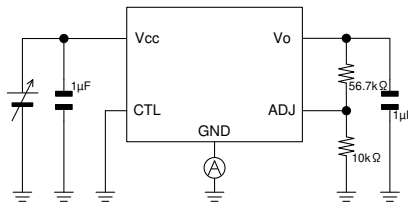

Measurement setup for Figure 12

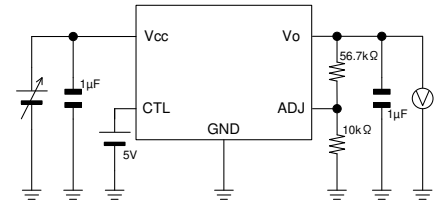

Measurement setup for Figure 13

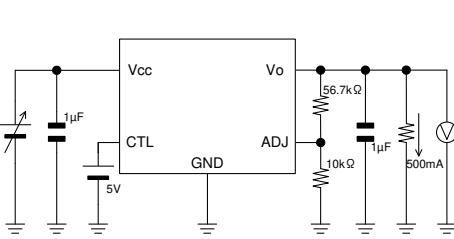

Measurement setup for Figure 14

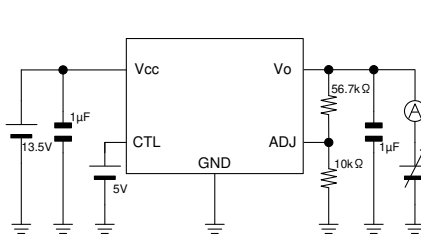

Measurement setup for Figure 15

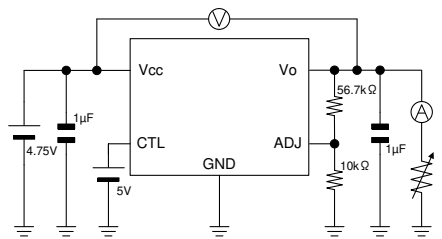

Measurement setup for Figure 16

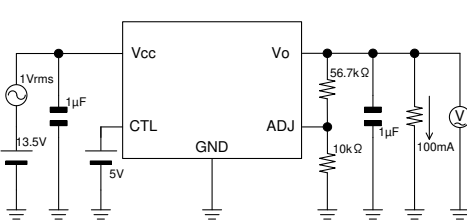

Measurement setup for Figure 17

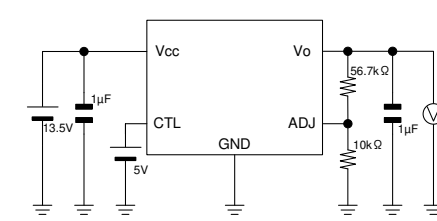

Measurement setup for Figure 18

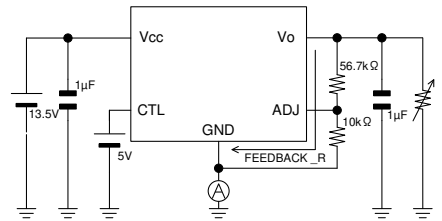

Measurement setup for Figure 19

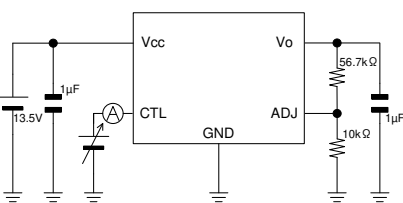

Measurement setup for Figure 20

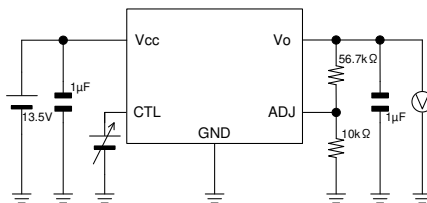

Measurement setup for Figure 21

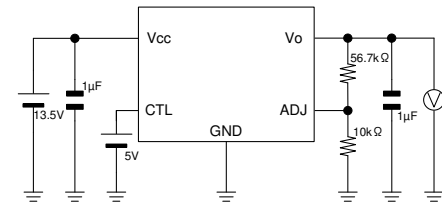

Measurement setup for Figure 22

Reference Data

■ BD33C0A-C/ BD33C0AW-C series

Unless otherwise specified, $-40^{\circ}\text{C} \leq T_a \leq +125^{\circ}\text{C}$, $V_{CC}=13.5\text{V}$, $V_{CTL}=5.0\text{V}$ (With SW), $I_o=0\text{mA}$

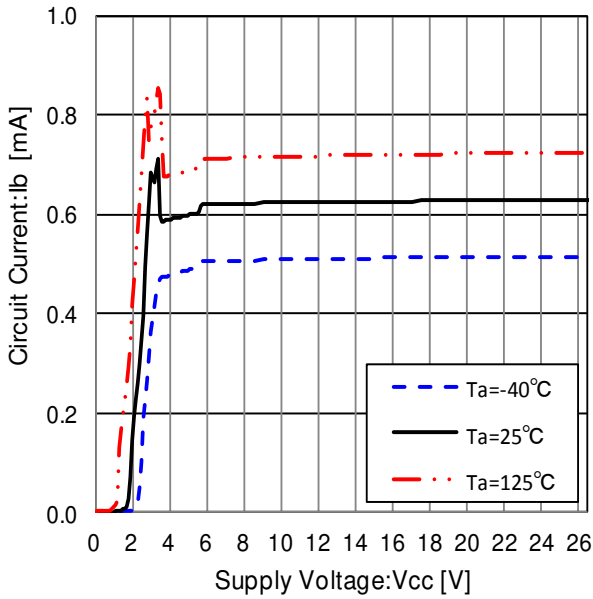

Figure 23. Circuit Current

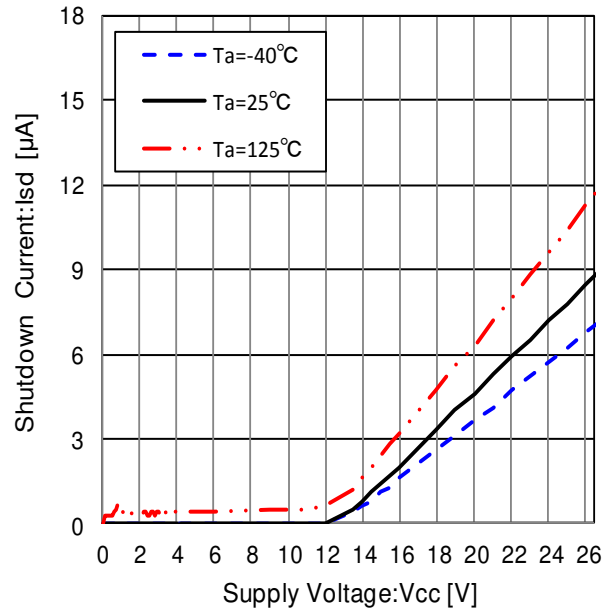

Figure 24. Shutdown Current ($V_{CTL}=0\text{V}$)

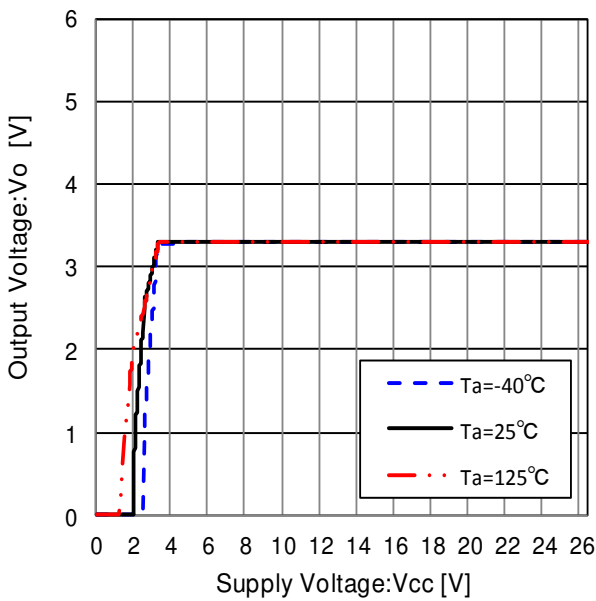

Figure 25. Line Regulation ($I_o=0\text{mA}$)

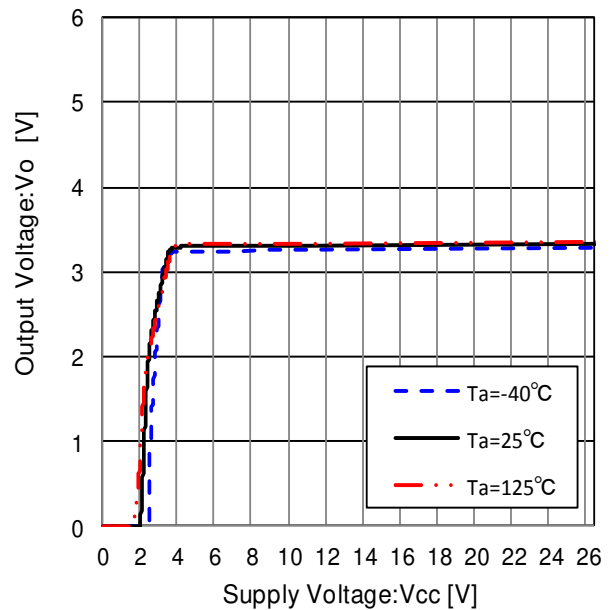

Figure 26. Line Regulation ($I_o=500\text{mA}$)

Reference Data - continued

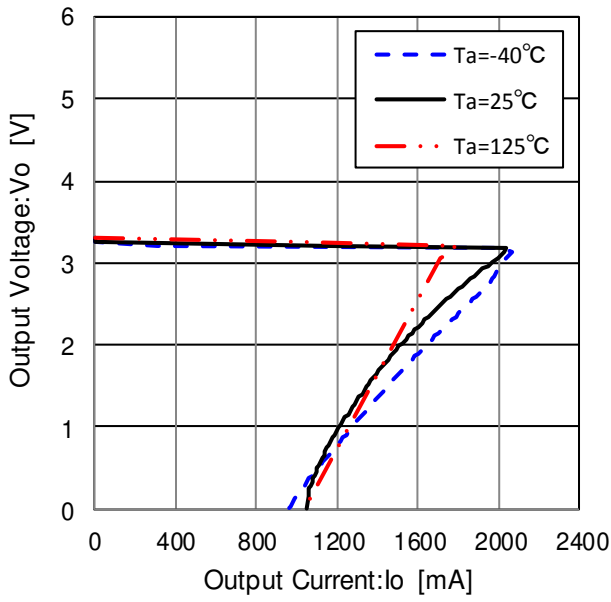

Figure 27. Load Regulation

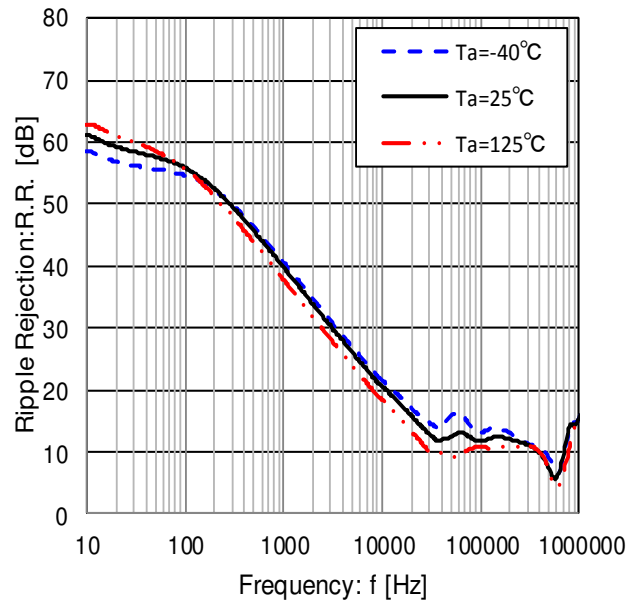

Figure 28. Ripple Rejection (Io=100mA)

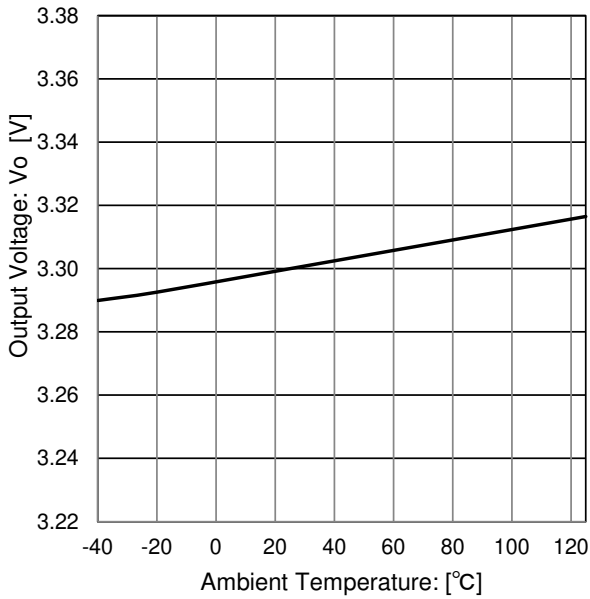

Figure 29. Output Voltage Temperature Characteristic

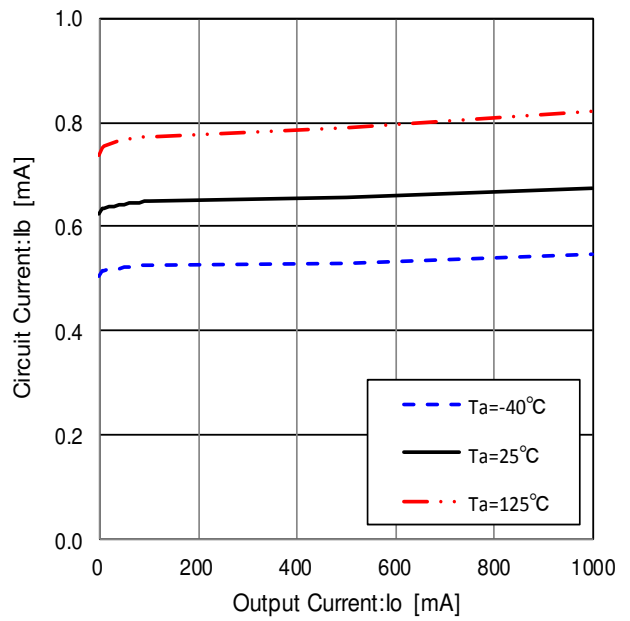

Figure 30. Circuit Current

Reference Data - continued

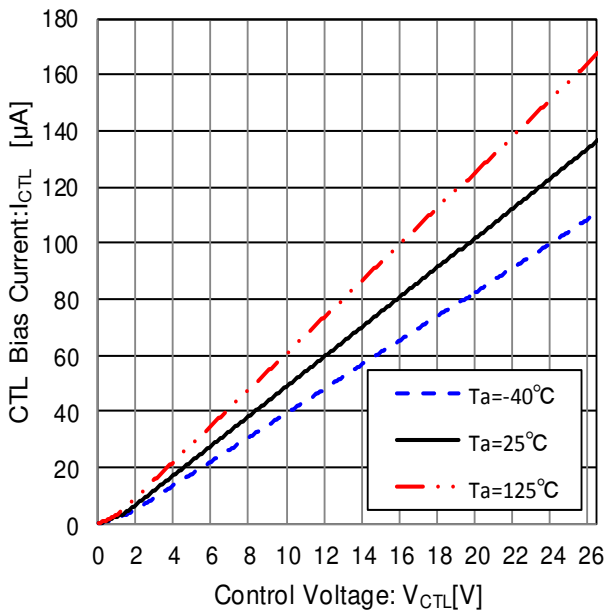

Figure 31. CTL Current vs CTL Voltage

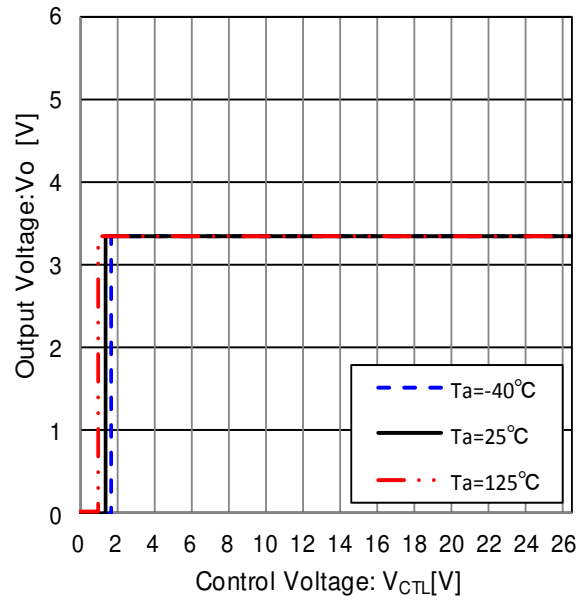

Figure 32. Output Voltage vs CTL Voltage

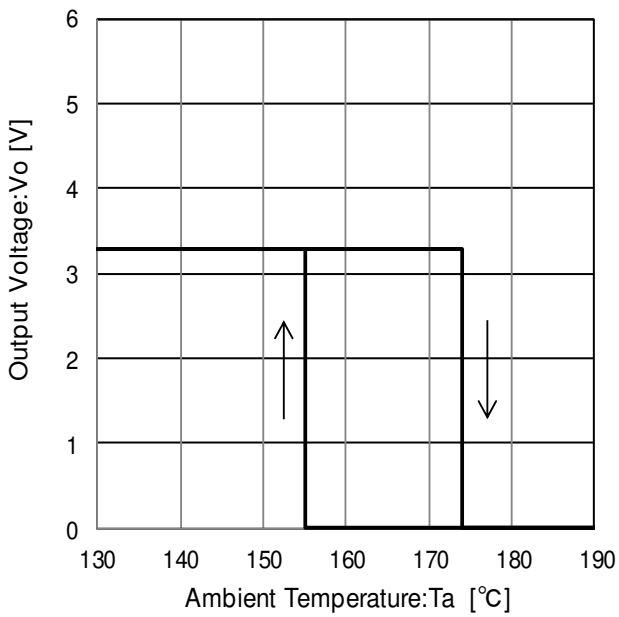

Figure 33. Thermal Shutdown Circuit Characteristic

Reference Data

■ BD50C0A-C/ BD50C0AW-C series

Unless otherwise specified, $-40^{\circ}\text{C} \leq T_a \leq +125^{\circ}\text{C}$, $V_{CC}=13.5\text{V}$, $V_{CTL}=5.0\text{V}$ (With SW), $I_o=0\text{mA}$

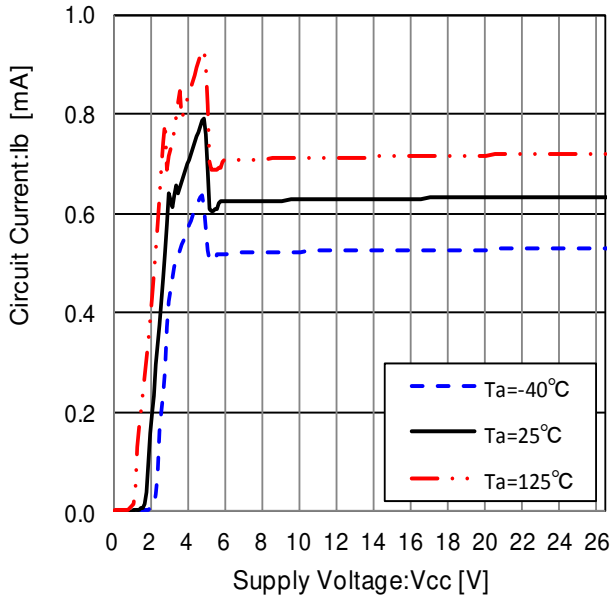

Figure 34. Circuit Current

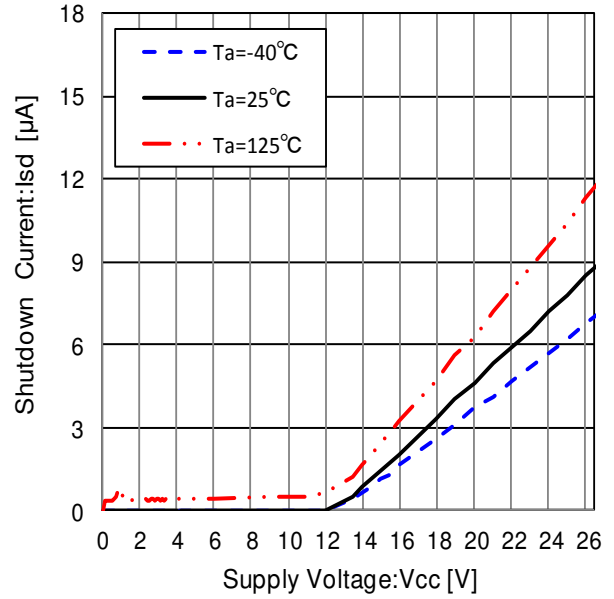

Figure 35. Shutdown Current ($V_{CTL}=0\text{V}$)

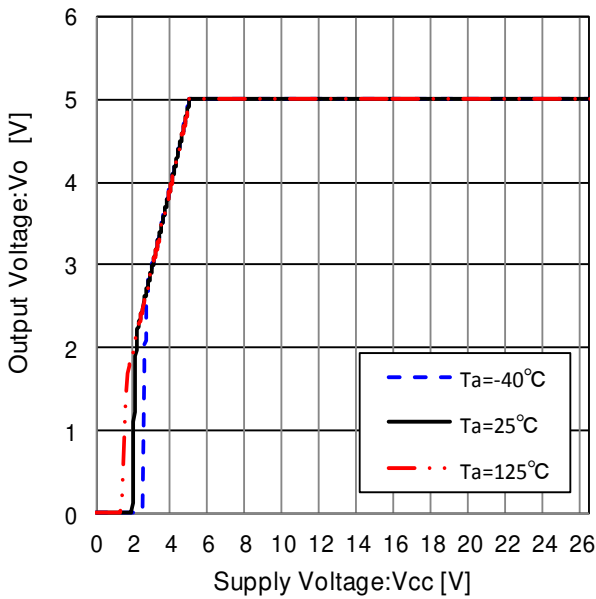

Figure 36. Line Regulation ($I_o=0\text{mA}$)

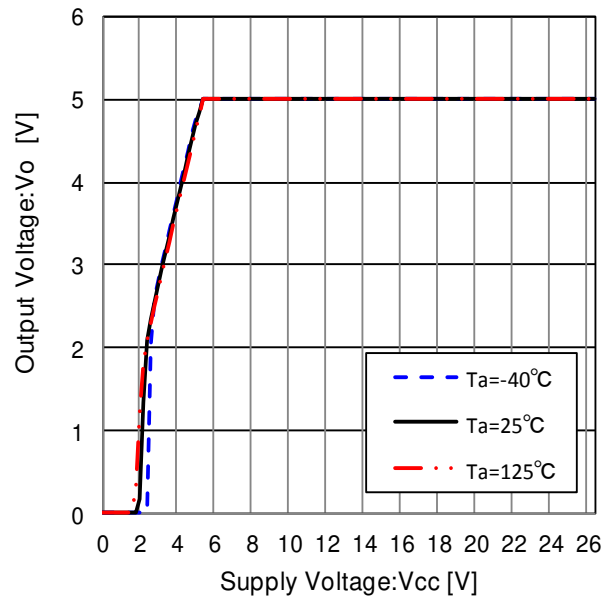

Figure 37. Line Regulation ($I_o=500\text{mA}$)

Reference Data - continued

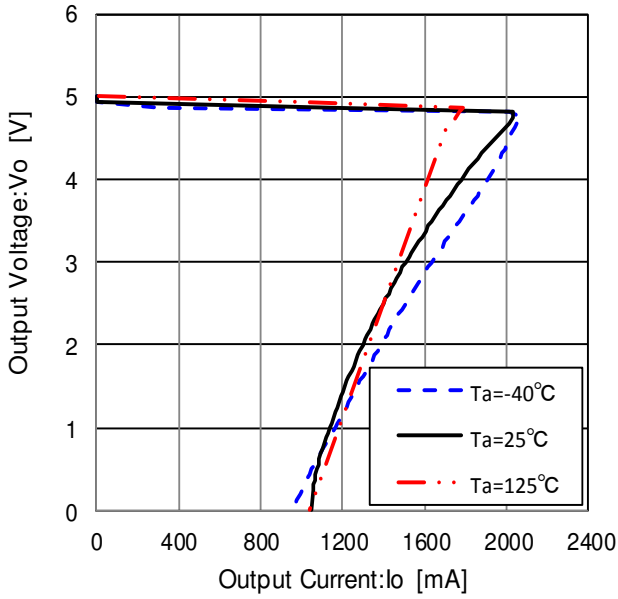

Figure 38. Load Regulation

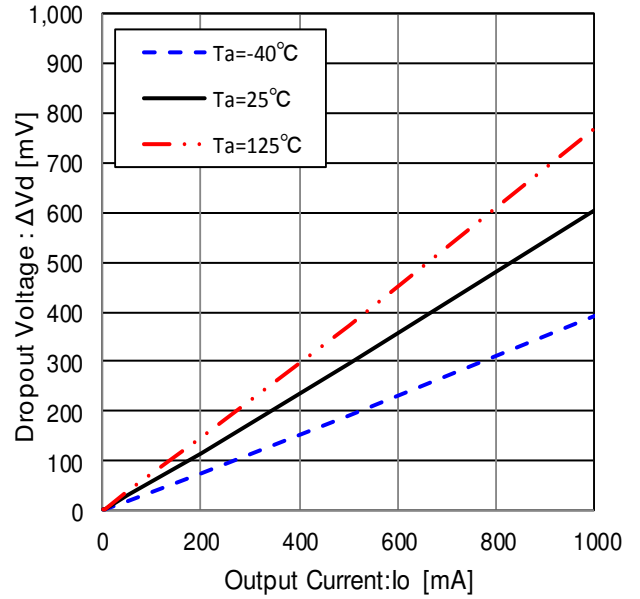

Figure 39. Dropout Voltage
(Vcc=Vo×0.95V=4.75V)

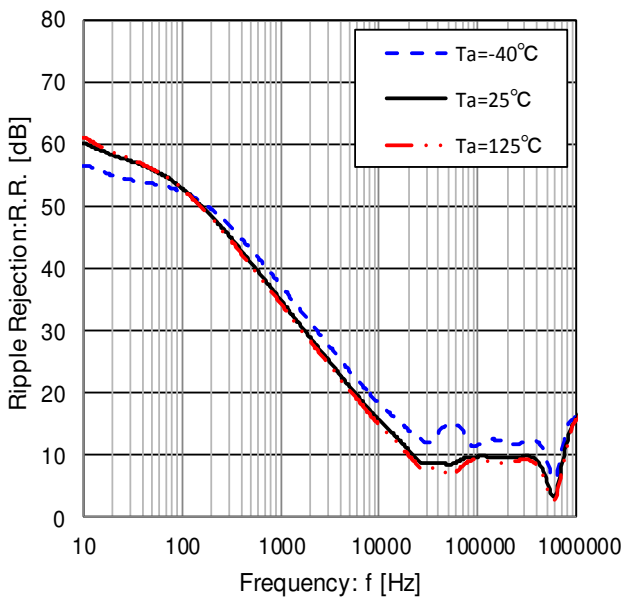

Figure 40. Ripple Rejection
(Io=100mA)

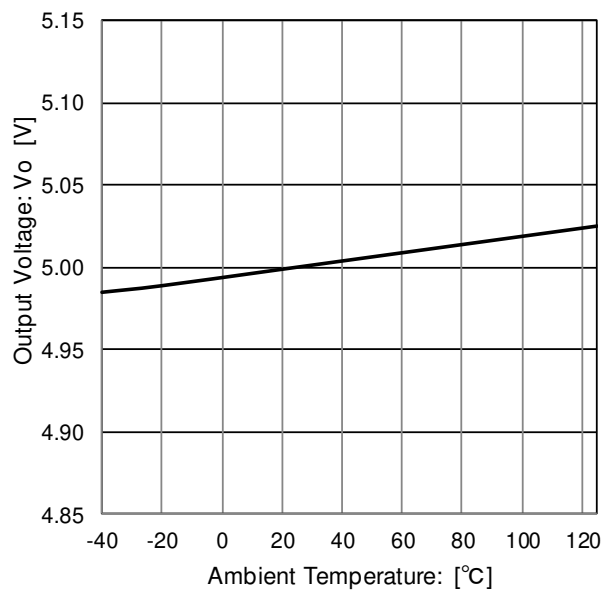

Figure 41. Output Voltage
Temperature Characteristic

Reference Data - continued

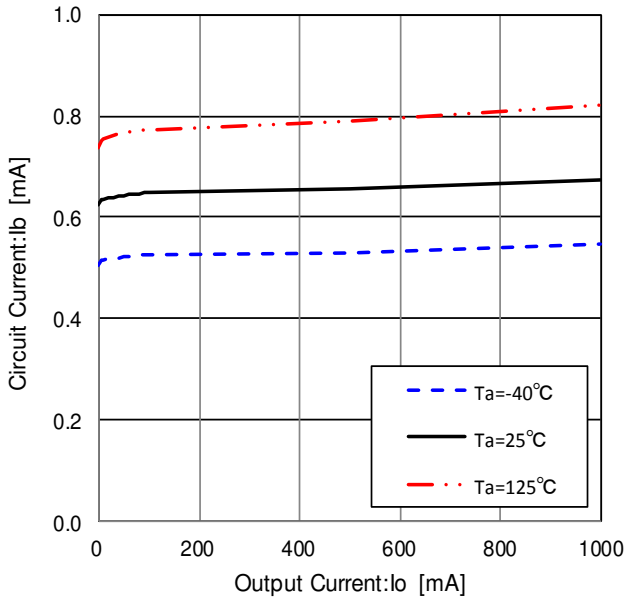

Figure 42. Circuit Current

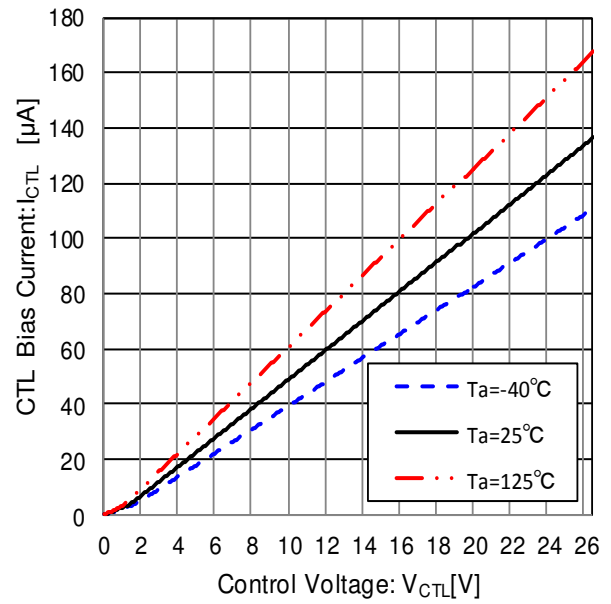

Figure 43. CTL Current vs CTL Voltage

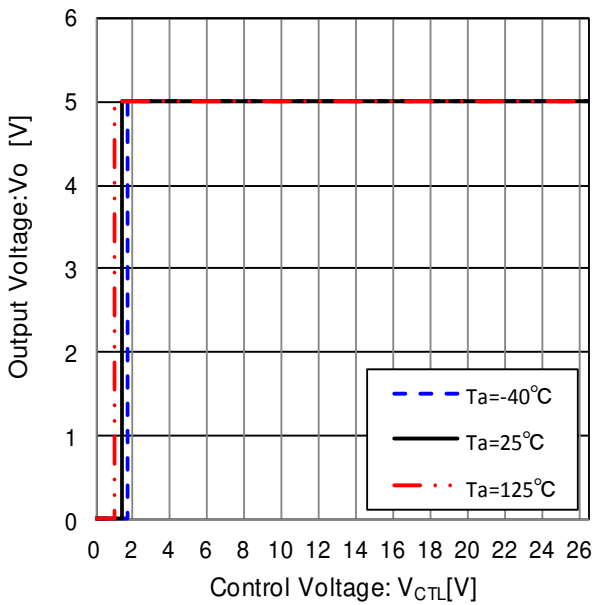

Figure 44. Output Voltage vs CTL Voltage

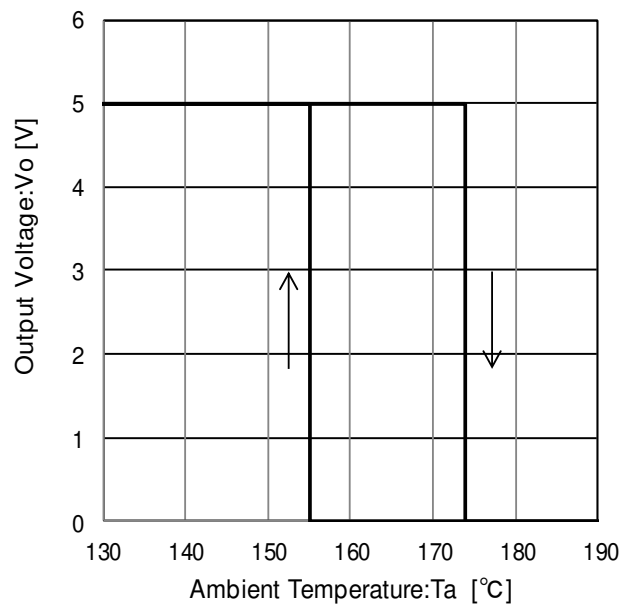

Figure 45. Thermal Shutdown Circuit Characteristic

Reference Data

■ BD80C0A-C/ BD80C0AW-C series

Unless otherwise specified, $-40^{\circ}\text{C} \leq T_a \leq +125^{\circ}\text{C}$, $V_{CC}=13.5\text{V}$, $V_{CTL}=5.0\text{V}$ (With SW), $I_o=0\text{mA}$

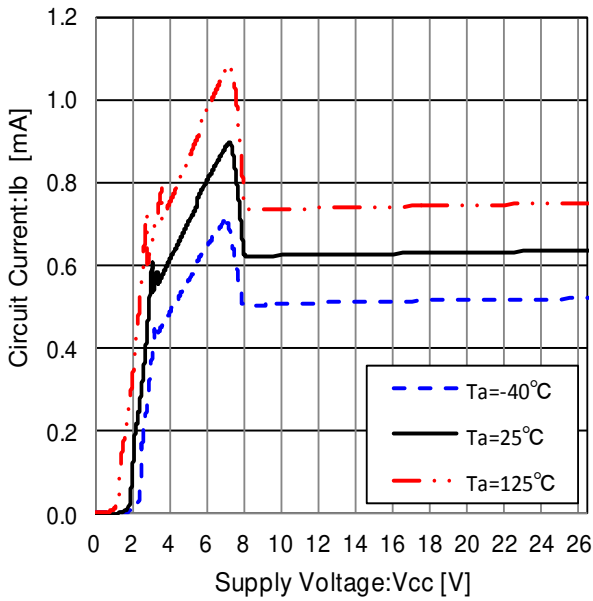

Figure 46. Circuit Current

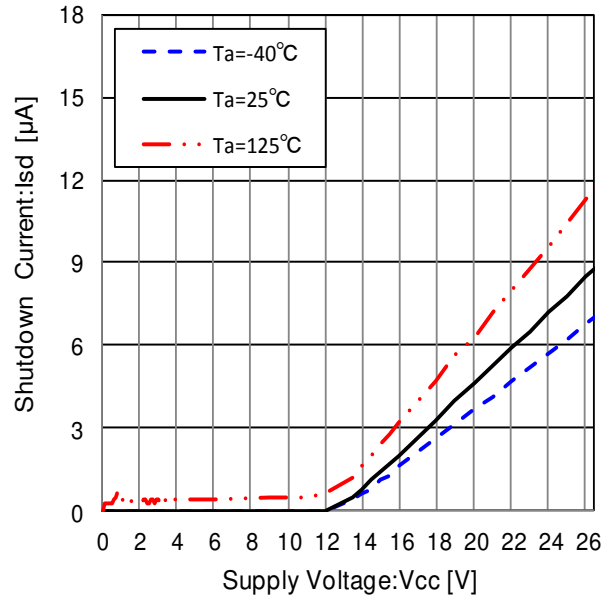

Figure 47. Shutdown Current ($V_{CTL}=0\text{V}$)

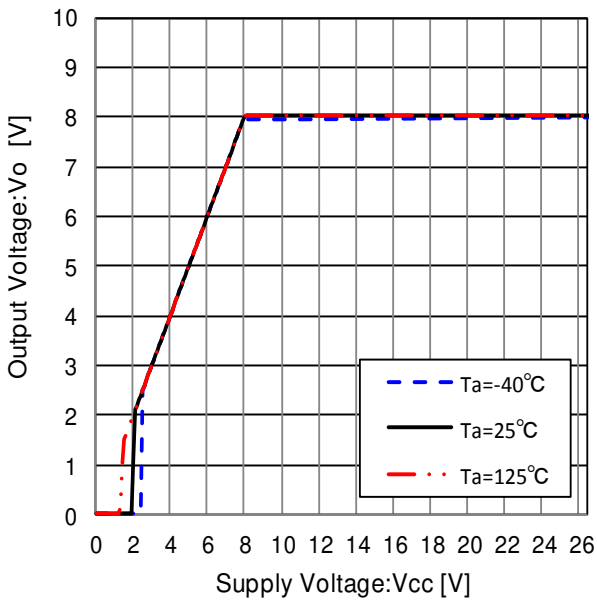

Figure 48. Line Regulation ($I_o=0\text{mA}$)

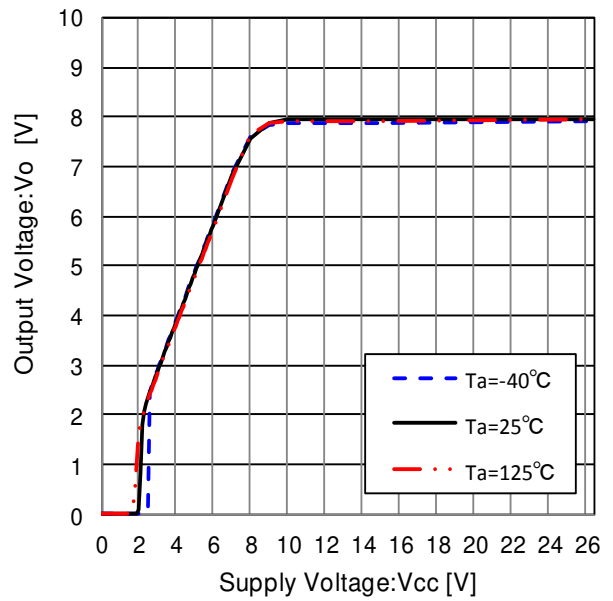

Figure 49. Line Regulation ($I_o=500\text{mA}$)

Reference Data - continued

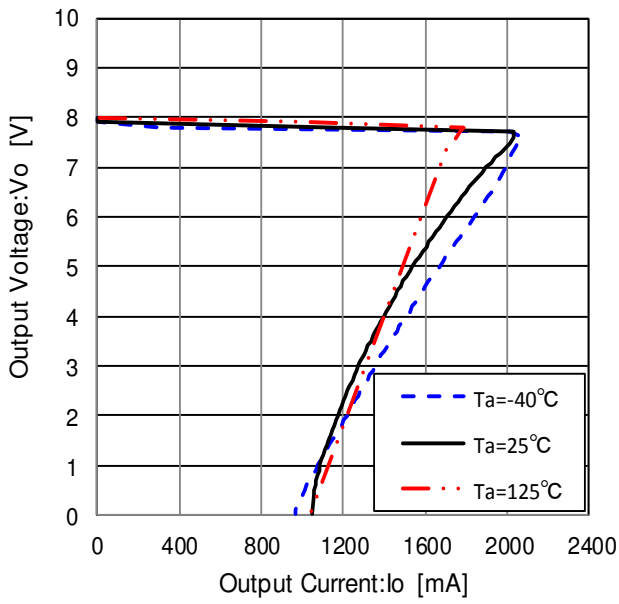

Figure 50. Load Regulation

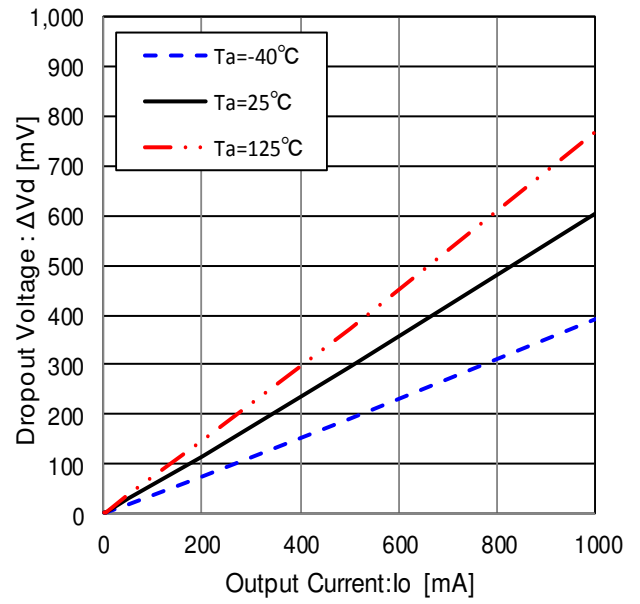

Figure 51. Dropout Voltage
($V_{CC}=V_o \times 0.95V=7.6V$)

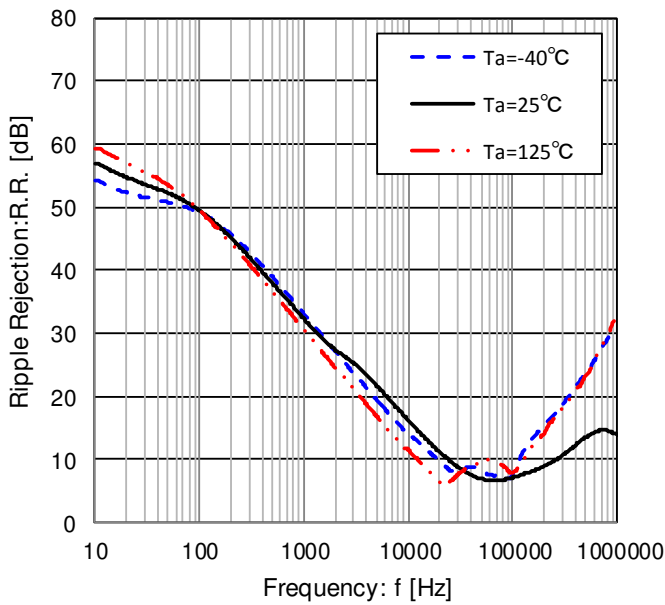

Figure 52. Ripple Rejection
($I_o=100mA$)

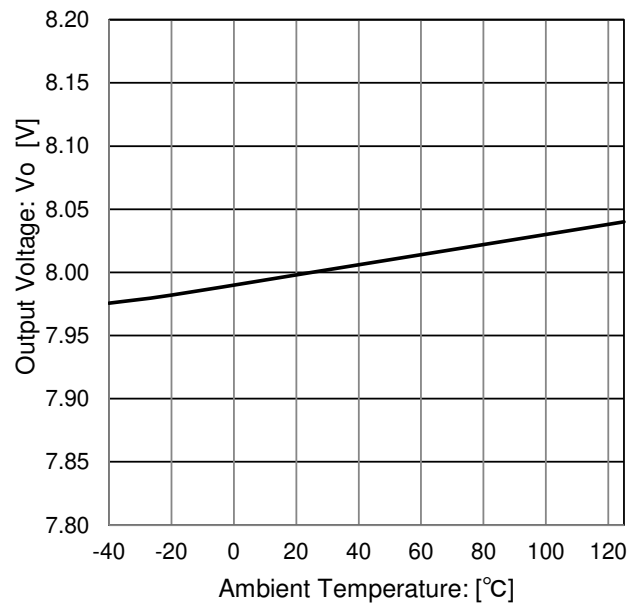

Figure 53. Output Voltage Temperature Characteristic

Reference Data - continued

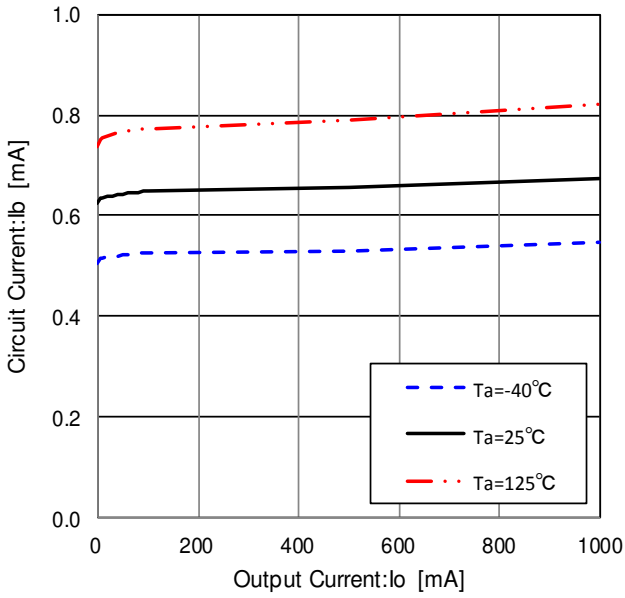

Figure 54. Circuit Current

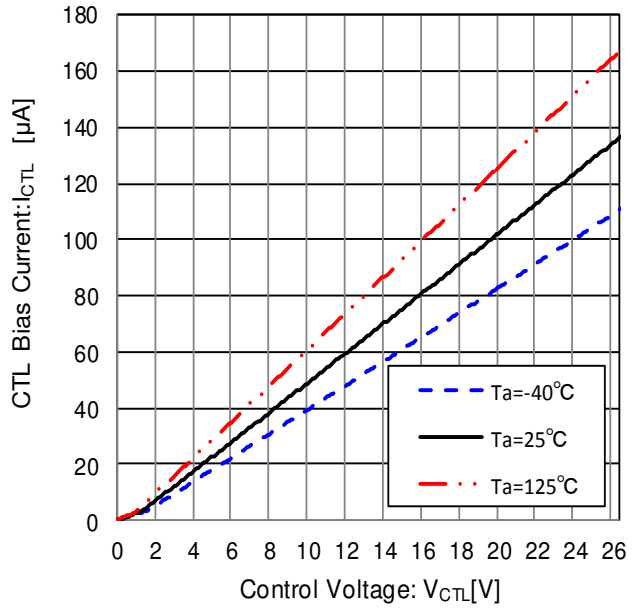

Figure 55. CTL Current vs CTL Voltage

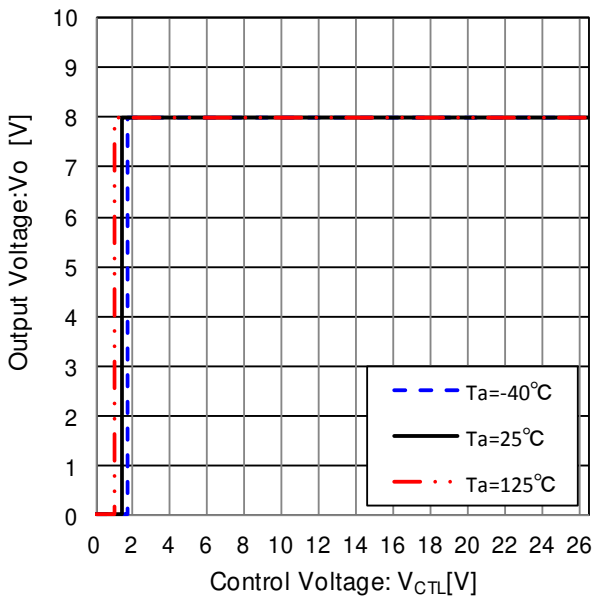

Figure 56. Output Voltage vs CTL Voltage

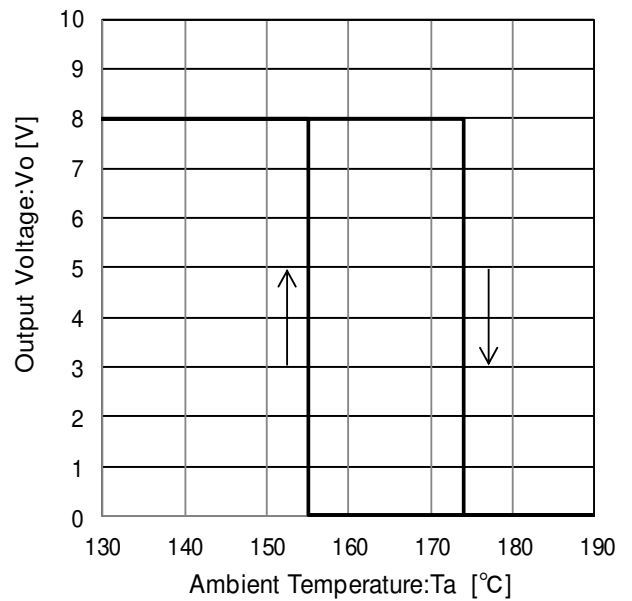

Figure 57. Thermal Shutdown Circuit Characteristic

Reference Data

■ BD90C0A-C/ BD90C0AW-C series

Unless otherwise specified, $-40^{\circ}\text{C} \leq T_a \leq +125^{\circ}\text{C}$, $V_{CC}=13.5\text{V}$, $V_{CTL}=5.0\text{V}$ (With SW), $I_o=0\text{mA}$

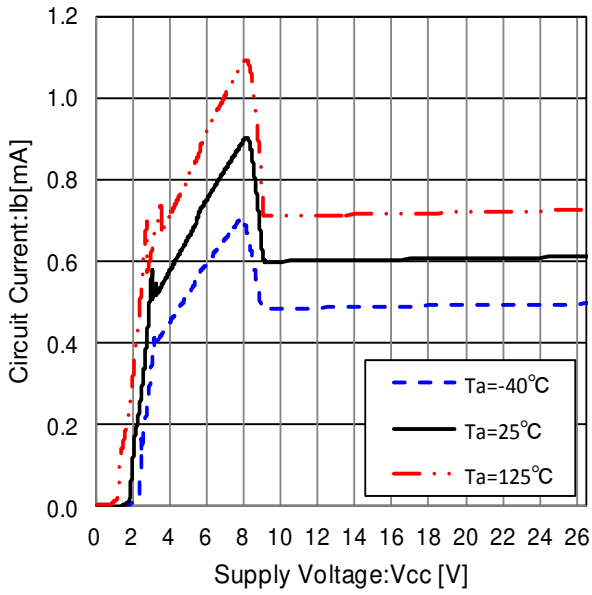

Figure 58. Circuit Current

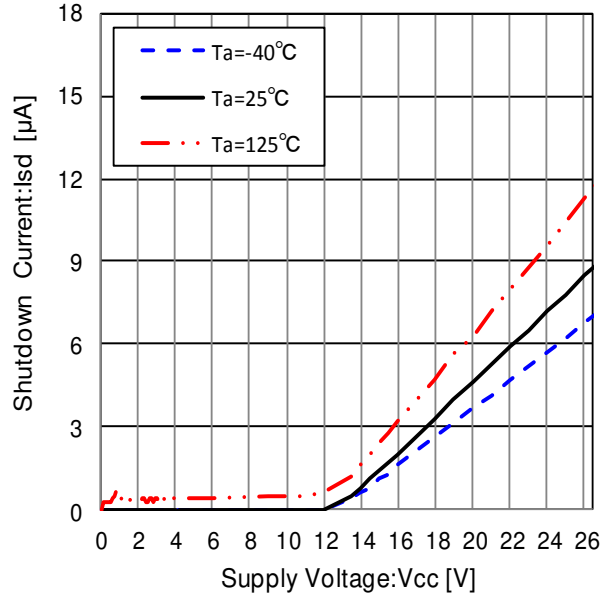

Figure 59. Shutdown Current ($V_{CTL}=0\text{V}$)

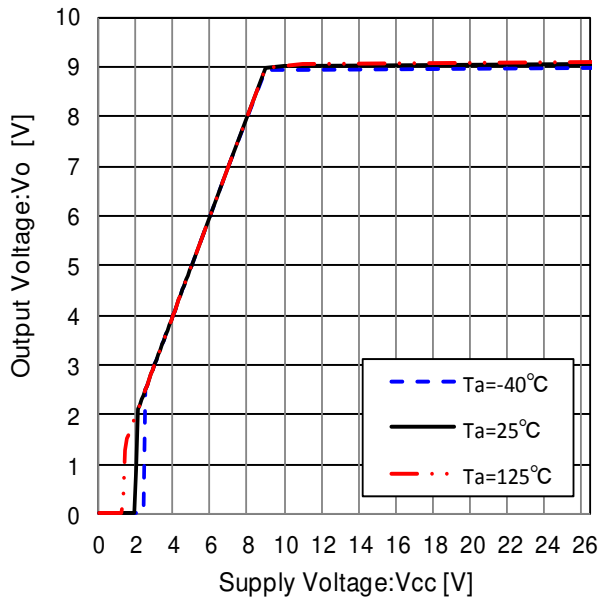

Figure 60. Line Regulation ($I_o=0\text{mA}$)

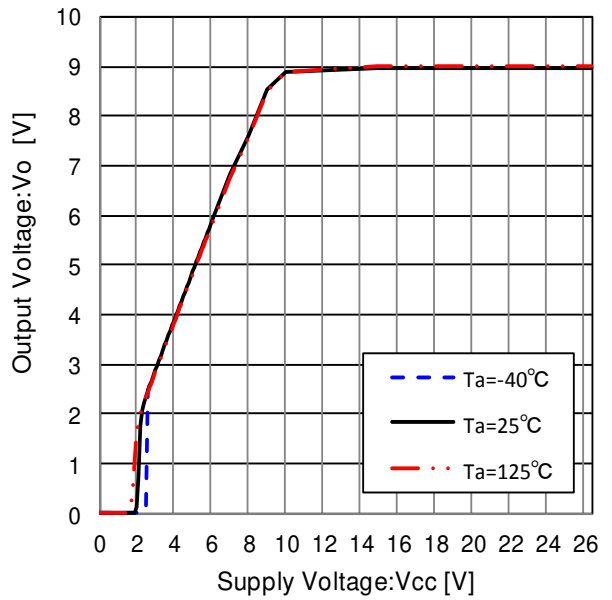

Figure 61. Line Regulation ($I_o=500\text{mA}$)

Reference Data - continued

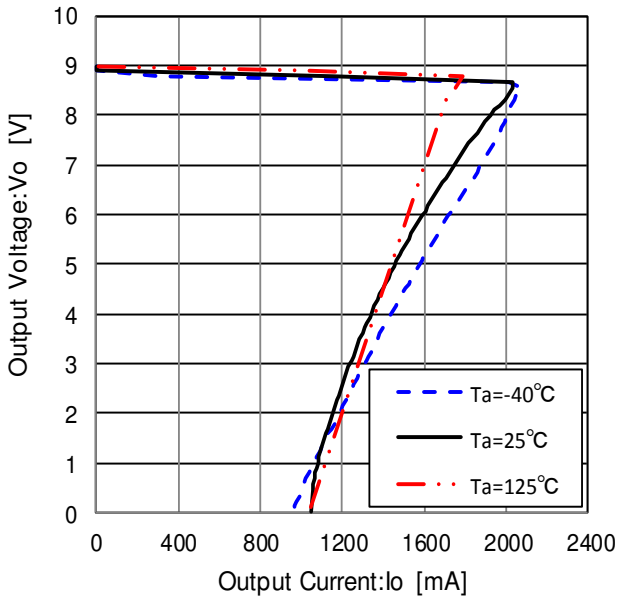

Figure 62. Load Regulation

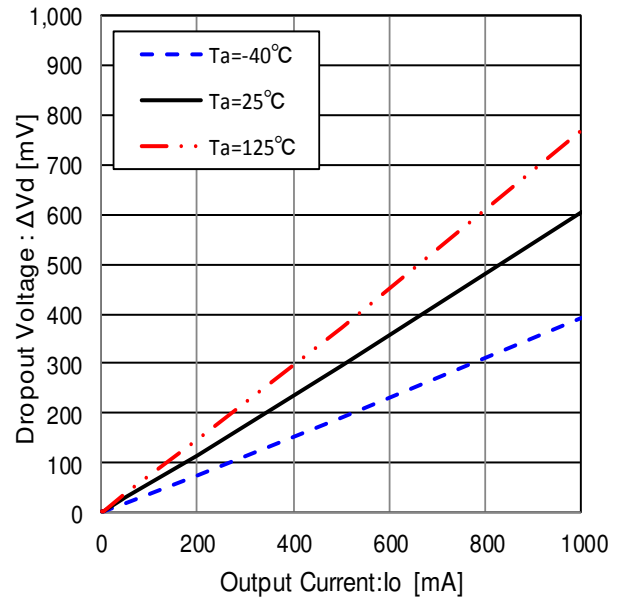

Figure 63. Dropout Voltage
(Vcc=Vo×0.95V=8.55V)

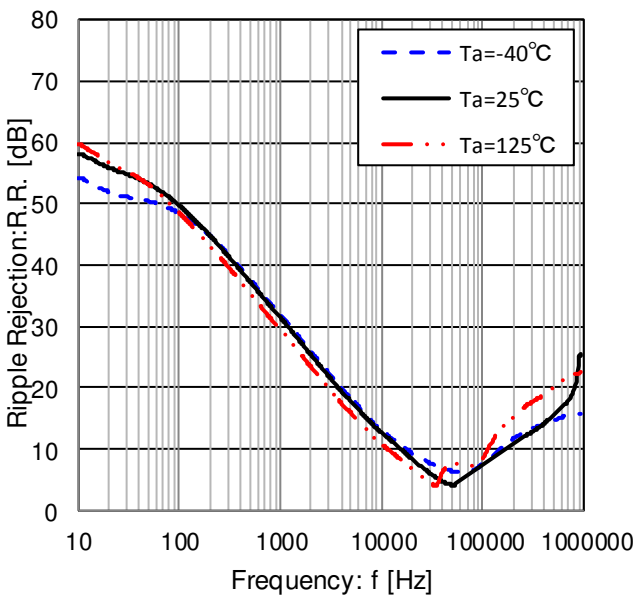

Figure 64. Ripple Rejection
(Io = 100mA)

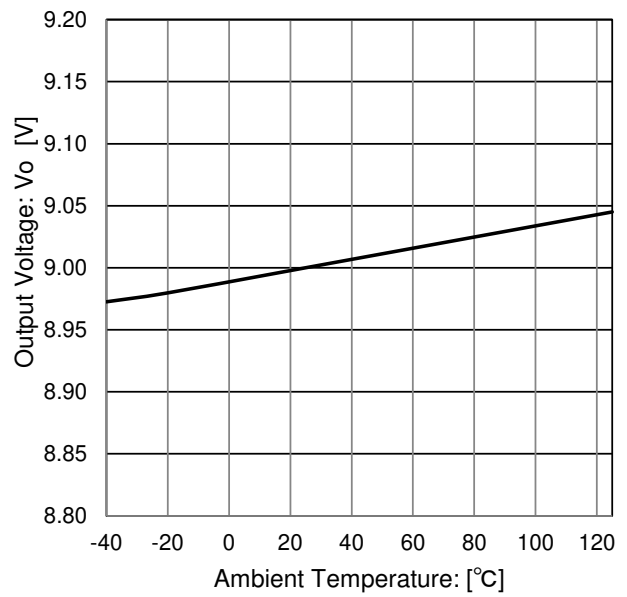

Figure 65. Output Voltage
Temperature Characteristic

Reference Data - continued

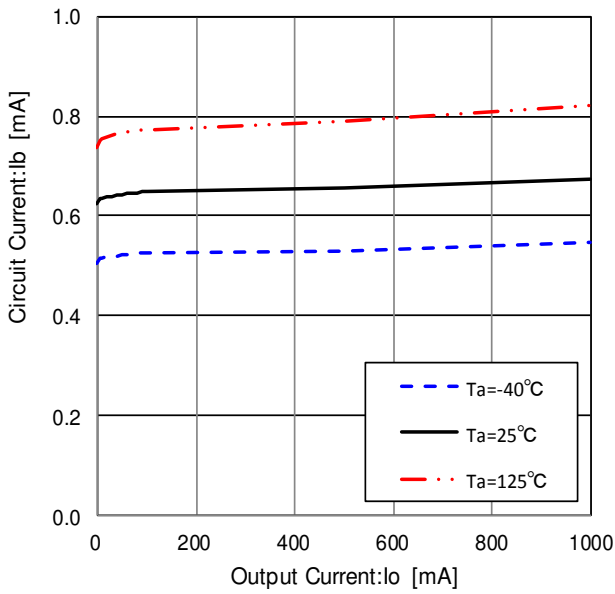

Figure 66. Circuit Current

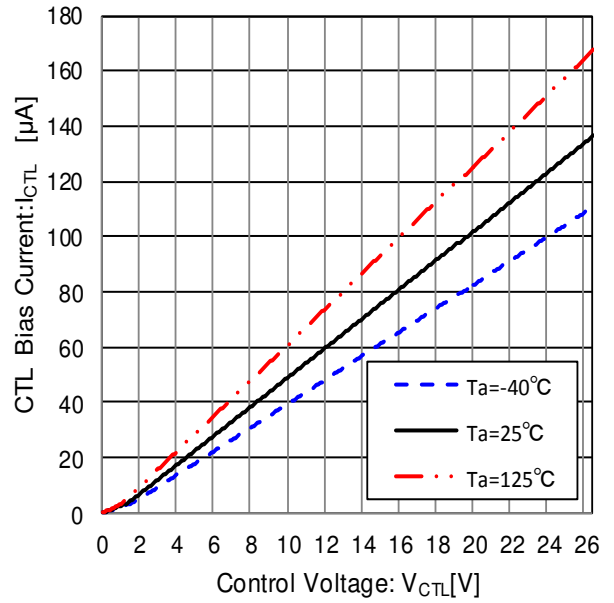

Figure 67. CTL Current vs CTL Voltage

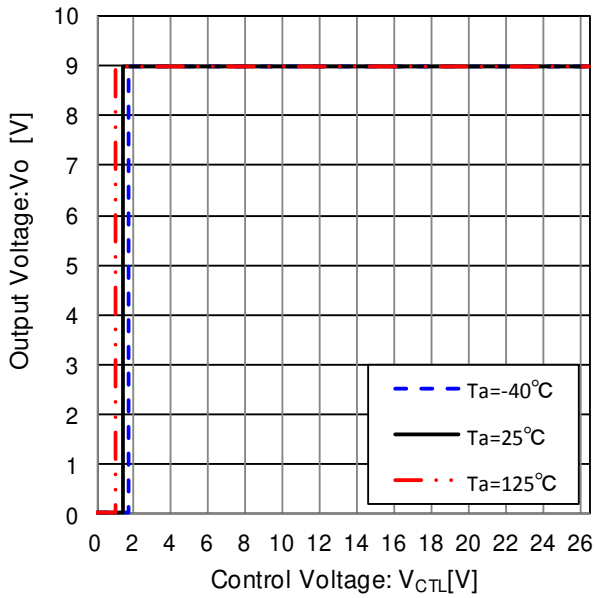

Figure 68. Output Voltage vs CTL Voltage

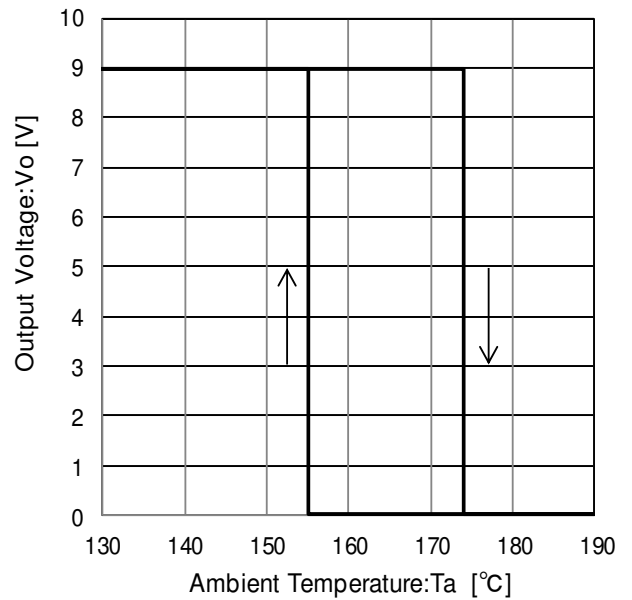
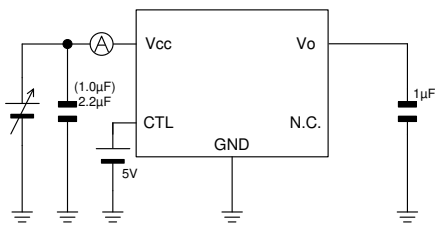

Figure 69. Thermal Shutdown Circuit Characteristic

Measurement setup for reference data

■ BDxxC0AW-C series(Output Voltage Fixation Type)



Measurement setup for Figure 23, 34, 46 and 58

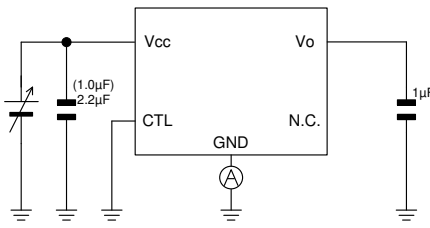

Measurement setup for Figure 24, 35, 47 and 59

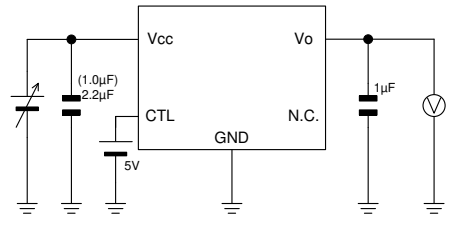

Measurement setup for Figure 25, 36, 48 and 60

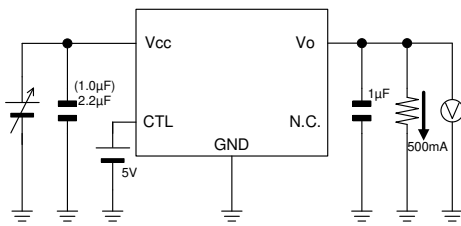

Measurement setup for Figure 26, 37, 49 and 61

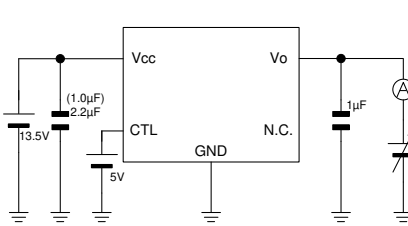

Measurement setup for Figure 27, 38, 50 and 62

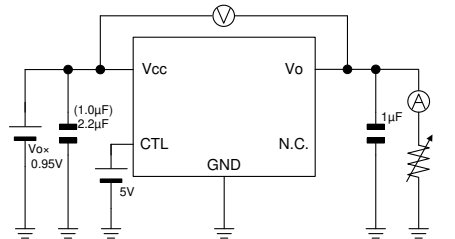

Measurement setup for Figure 39, 51 and 63

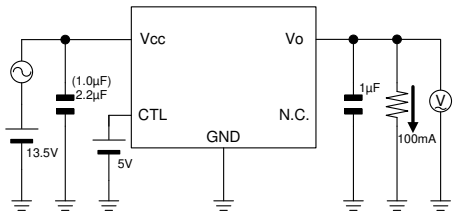

Measurement setup for Figure 28, 40, 52 and 64

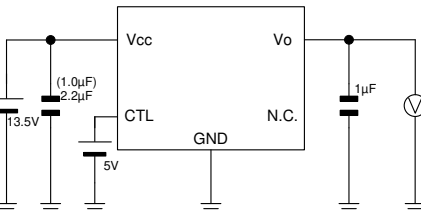

Measurement setup for Figure 29, 41, 53 and 65

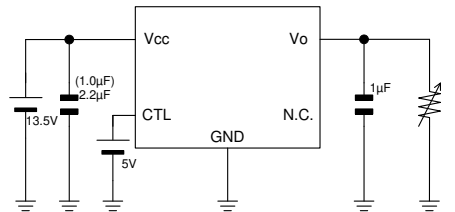

Measurement setup for Figure 30, 42, 54 and 66

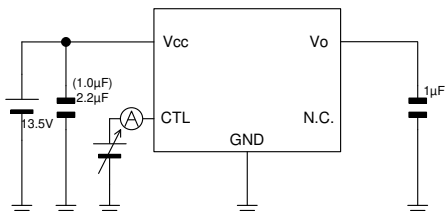

Measurement setup for Figure 31, 43, 55 and 67

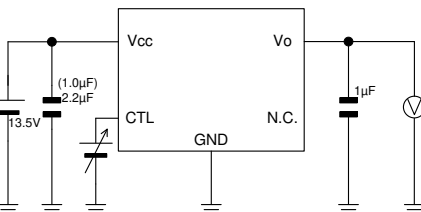

Measurement setup for Figure 32, 44, 56 and 68

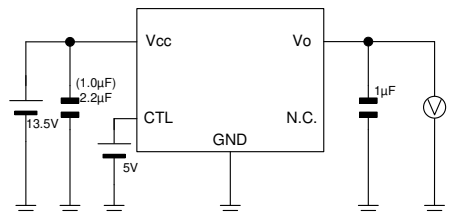

Measurement setup for Figure 33, 45, 57 and 69