



Chipsmall Limited consists of a professional team with an average of over 10 year of expertise in the distribution of electronic components. Based in Hongkong, we have already established firm and mutual-benefit business relationships with customers from,Europe,America and south Asia,supplying obsolete and hard-to-find components to meet their specific needs.

With the principle of “Quality Parts,Customers Priority,Honest Operation,and Considerate Service”,our business mainly focus on the distribution of electronic components. Line cards we deal with include Microchip,ALPS,ROHM,Xilinx,Pulse,ON,Everlight and Freescale. Main products comprise IC,Modules,Potentiometer,IC Socket,Relay,Connector.Our parts cover such applications as commercial,industrial, and automotives areas.

We are looking forward to setting up business relationship with you and hope to provide you with the best service and solution. Let us make a better world for our industry!



## Contact us

Tel: +86-755-8981 8866 Fax: +86-755-8427 6832

Email & Skype: info@chipsmall.com Web: www.chipsmall.com

Address: A1208, Overseas Decoration Building, #122 Zhenhua RD., Futian, Shenzhen, China



# 7.0V to 36V Input, 2.5A Integrated MOSFET Single Synchronous Buck DC/DC Converter

## BD9E301EFJ-LB

### General Description

This product guarantees long time support in Industrial market.

BD9E301EFJ-LB is a synchronous buck switching regulator with built-in power MOSFETs. It is capable of an output current of up to 2.5A. It is a current mode control DC/DC converter and features high-speed transient response. Phase compensation can also be set easily.

### Features

- Long Time Support Product for Industrial Applications.
- Synchronous single DC/DC converter.
- Over-Current Protection.
- Short Circuit Protection.
- Thermal Shutdown Protection.
- Undervoltage Lockout Protection.
- Soft Start.
- HTSOP-J8 package (Exposed Pad).

### Applications

- Industrial Equipment.
- Power supply for FA's industrial device using 24V bass.
- Consumer applications such as home appliance. Distribution type power supply system for 12V, and 24V.

### Key Specifications

- Input Voltage Range: 7.0V to 36V
- Output Voltage Range: 1.0V to  $V_{IN} \times 0.7V$
- Output Current: 2.5A (Max)
- Switching Frequency: 570kHz (Typ)
- High-Side MOSFET ON-Resistance: 170m $\Omega$  (Typ)
- Low-Side MOSFET ON-Resistance: 140m $\Omega$  (Typ)
- Standby Current: 0 $\mu$ A (Typ)

### Package

HTSOP-J8

W (Typ) x D (Typ) x H (Max)

4.90mm x 6.00mm x 1.00mm

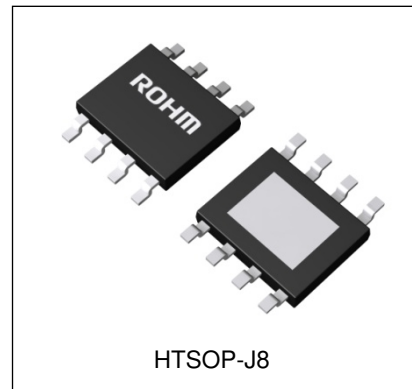

### Typical Application Circuit

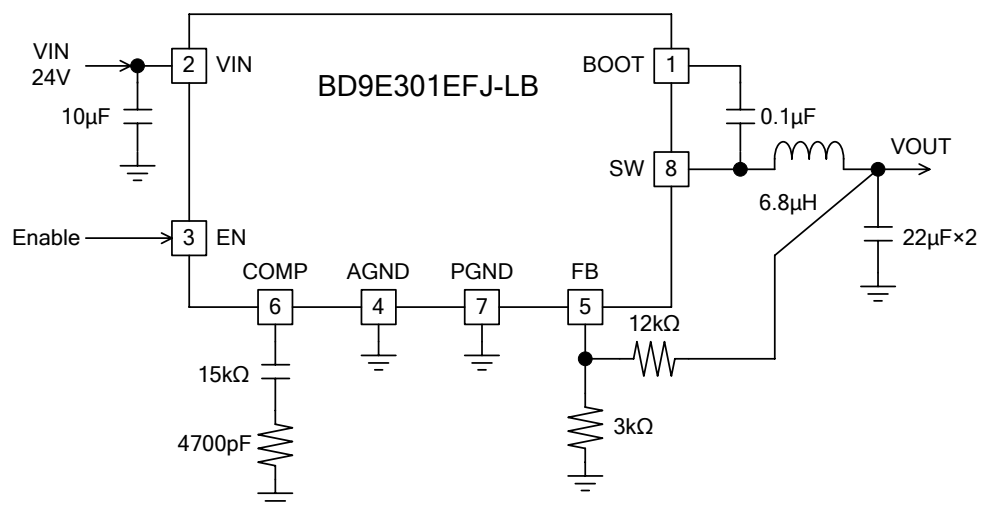

Figure 1. Application circuit

Pin Configuration

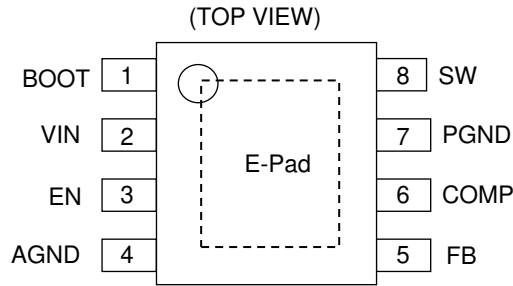

Figure 2. Pin assignment

Pin Description(s)

Pin No	Pin Name	Description
1	BOOT	Connect a bootstrap capacitor of 0.1μF between this terminal and SW terminal. The voltage of this capacitor is the gate drive voltage of the high-side MOSFET.
2	VIN	Power supply terminal for the switching regulator and control circuit. Connecting a 10μF ceramic capacitor is recommended.
3	EN	Turning this terminal signal low-level (0.8V or lower) forces the device to enter the shut down mode. Turning this terminal signal high-level (2.5V or higher) enables the device. This terminal must be terminated.
4	AGND	Ground terminal for the control circuit.
5	FB	Inverting input node for the gm error amplifier. See page 22 on how to calculate the resistance of the output voltage setting.
6	COMP	Input terminal for the gm error amplifier output and the output switch current comparator. Connect a frequency phase compensation component to this terminal. See page 23 on how to calculate the resistance and capacitance for phase compensation.
7	PGND	Ground terminal for the output stage of the switching regulator.
8	SW	Switch node. This terminal is connected to the source of the high-side MOSFET and drain of the low-side MOSFET. Connect a bootstrap capacitor of 0.1μF between this terminal and BOOT terminal. In addition, connect an inductor considering the direct current superimposition characteristic.
-	E-Pad	Exposed pad. Connecting this to the internal PCB ground plane using multiple vias provides excellent heat dissipation characteristics.

Block Diagram

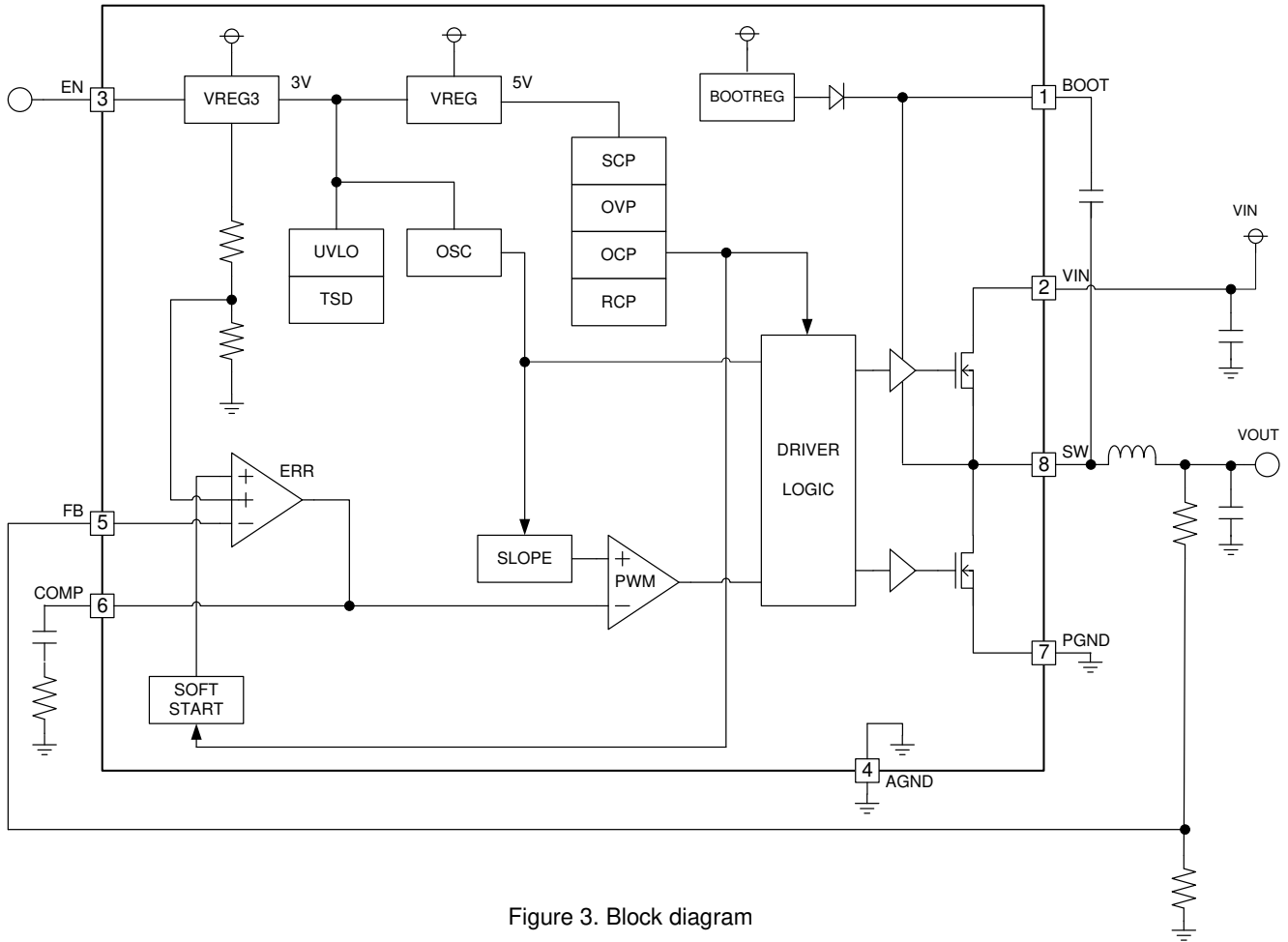

Figure 3. Block diagram

## Description of Block

- **VREG3**  
Block creating internal reference voltage 3V (Typ).
- **VREG**  
Block creating internal reference voltage 5V (Typ).
- **BOOTREG**  
Block creating gate drive voltage.
- **TSD**  
This is the thermal shutdown block. Thermal shutdown circuit shuts down the whole system if temperature exceeds 175°C (Typ). When the temperature decreases, it returns to normal operation with hysteresis of 25°C (Typ).
- **UVLO**  
This is the under voltage lock-out block. IC shuts down when VIN is under 6.4V (Typ). The threshold voltage has a hysteresis of 200mV (Typ).
- **ERR**  
This circuit compares the feedback voltage at the output to the reference voltage. The output of this circuit is the COMP terminal voltage and this determines the switching duty. Also, because of soft start during start-up, COMP terminal voltage is controlled by internal slope voltage.
- **OSC**  
Block generating oscillation frequency.
- **SLOPE**  
This circuit creates a triangular wave from generated clock in OSC. The voltage converted from current sense signal of high side MOSFET and the triangular wave is sent to PWM comparator.
- **PWM**  
This block determines the switching duty by comparing the output COMP terminal voltage of error amplifier and output of SLOPE block.
- **DRIVER LOGIC**  
This is the DC/DC driver block. Input to this block is signal from PWM and output drives the MOSFETs.
- **SOFT START**  
This circuit prevents the overshoot of output voltage and In-rush current by forcing the output voltage to rise slowly, thus, avoiding surges in current during start-up.
- **OCP**  
This block limits the current flowing in high side MOSFET for each cycle of switching frequency during over-current.
- **RCP**  
This block limits the current flowing in low side MOSFET for each cycle of switching frequency during over-current.
- **SCP**  
The short circuit protection block compares the FB terminal voltage with the internal standard voltage VREF. When the FB terminal voltage has fallen below 0.85V (Typ) and remained in that state for 1.0msec (Typ), SCP activates and stops the operation for 16msec (Typ) and subsequently initiates a restart.
- **OVP**  
Over voltage protection function (OVP) compares FB terminal voltage with the internal standard voltage VREF. When the FB terminal voltage exceeds 1.30V (Typ), it turns output MOSFETs off. When output voltage drops until it reaches the hysteresis, it will return to normal operation.

## Absolute Maximum Ratings (Ta = 25°C)

Parameter	Symbol	Rating	Unit
Supply Voltage	V <sub>IN</sub>	-0.3 to +40	V
EN Input Voltage	V <sub>EN</sub>	-0.3 to +40	V
Voltage from GND to BOOT	V <sub>BOOT</sub>	-0.3 to +45	V
Voltage from SW to BOOT	ΔV <sub>BOOT</sub>	-0.3 to +7	V
FB Input Voltage	V <sub>FB</sub>	-0.3 to +7	V
COMP Input Voltage	V <sub>COMP</sub>	-0.3 to +7	V
SW Input Voltage	V <sub>SW</sub>	-0.5 to V <sub>IN</sub> + 0.3	V
Allowable Power Dissipation	P <sub>d</sub>	3.75 <sup>(Note 1)</sup>	W
Operating Junction Temperature Range	T <sub>j</sub>	-40 to +150	°C
Storage Temperature Range	T <sub>stg</sub>	-55 to +150	°C

(Note 1) Derating is done 30.08 mW/°C for operating above Ta ≥ 25°C (Mount on 4-layer 70.0mm x 70.0mm x 1.6mm board)

**Caution1:** Operating the IC over the absolute maximum ratings may damage the IC. The damage can either be a short circuit between pins or an open circuit between pins and the internal circuitry. Therefore, it is important to consider circuit protection measures, such as adding a fuse, in case the IC is operated over the absolute maximum ratings.

**Caution2:** Reliability is decreased at junction temperature greater than 125°C.

## Recommended Operating Conditions

Parameter	Symbol	Rating			Unit
		Min	Typ	Max	
Supply Voltage	V <sub>IN</sub>	7.0	-	36	V
Output Current	I <sub>OUT</sub>	0	-	2.5	A
Output Voltage Range	V <sub>RANGE</sub>	1.0 <sup>(Note 2)</sup>	-	V <sub>IN</sub> × 0.7	V

(Note 2) Please use it in I/O voltage setting of which output pulse width does not become 150nsec (Typ) or less. See the page 22 for how to calculate the resistance of the output voltage setting.

Electrical Characteristics (Unless otherwise specified V<sub>IN</sub>=24V V<sub>EN</sub>=3V Ta=25°C)

Parameter	Symbol	Limit			Unit	Conditions
		Min	Typ	Max		
Supply Current in Operating	I <sub>OPR</sub>	-	1.5	2.5	mA	V <sub>FB</sub> = 1.1V No switching
Supply Current in Standby	I <sub>STBY</sub>	-	0	10	μA	V <sub>EN</sub> = 0V
Reference Voltage	V <sub>FB</sub>	0.98	1.00	1.02	V	
FB Input Current	I <sub>FB</sub>	-1	0	1	μA	V <sub>FB</sub> = 0V
Switching frequency	F <sub>OSC</sub>	484	570	656	kHz	
Maximum Duty ratio	Maxduty	85	90	95	%	
High-side FET on-resistance	R <sub>ONH</sub>	-	170	-	mΩ	I <sub>sw</sub> = 100mA
Low-side FET on-resistance	R <sub>ONL</sub>	-	140	-	mΩ	I <sub>sw</sub> = 100mA
Over Current limit	I <sub>LIMIT</sub>	-	5.0	-	A	
UVLO detection voltage	V <sub>UVLO</sub>	6.1	6.4	6.7	V	V <sub>IN</sub> falling
UVLO hysteresis voltage	V <sub>UVLOHYS</sub>	100	200	300	mV	
EN high-level input voltage	V <sub>ENH</sub>	2.5	-	V <sub>IN</sub>	V	
EN low-level input voltage	V <sub>ENL</sub>	-	-	0.8	V	
EN Input current	I <sub>EN</sub>	2.1	4.2	8.4	μA	V <sub>EN</sub> = 3V
Soft Start time	T <sub>SS</sub>	1.5	3.0	6.0	msec	EN rising to FB=0.85V

- V<sub>FB</sub> : FB Input Voltage. V<sub>EN</sub> : EN Input Voltage.
- P<sub>d</sub> should not be exceeded.



Typical Performance Curves

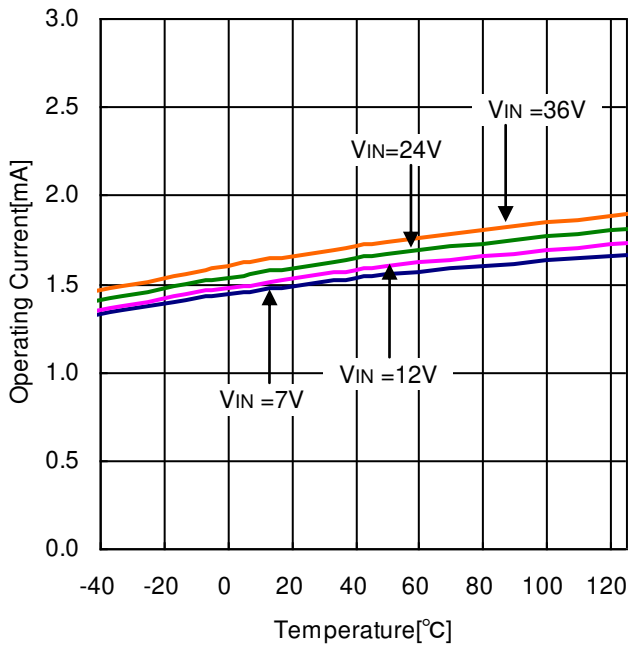

Figure 4. Operating Current vs Junction Temperature

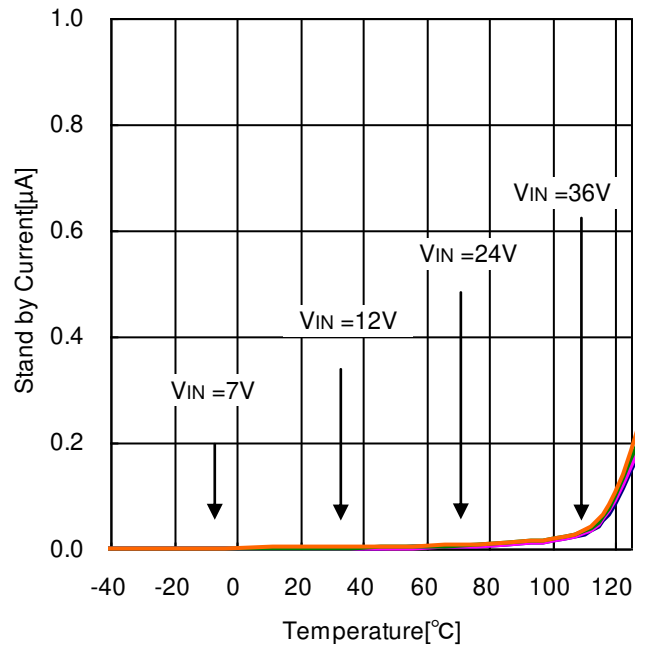

Figure 5. Stand-by Current vs Junction Temperature

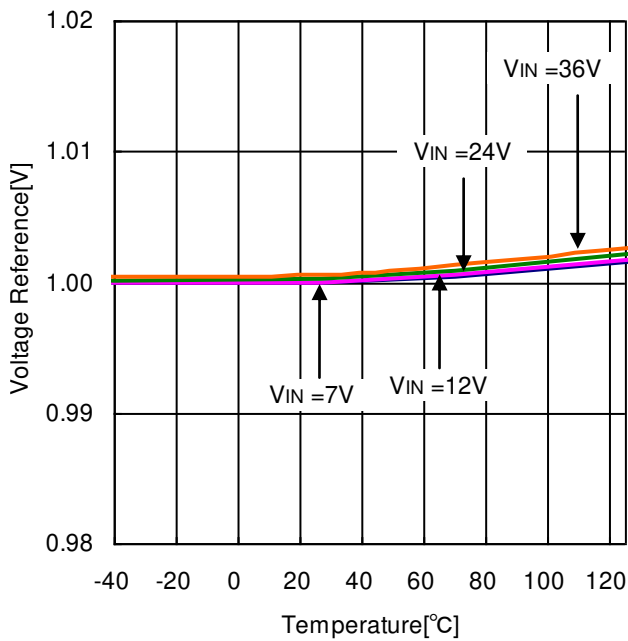

Figure 6. FB Voltage Reference vs Junction Temperature

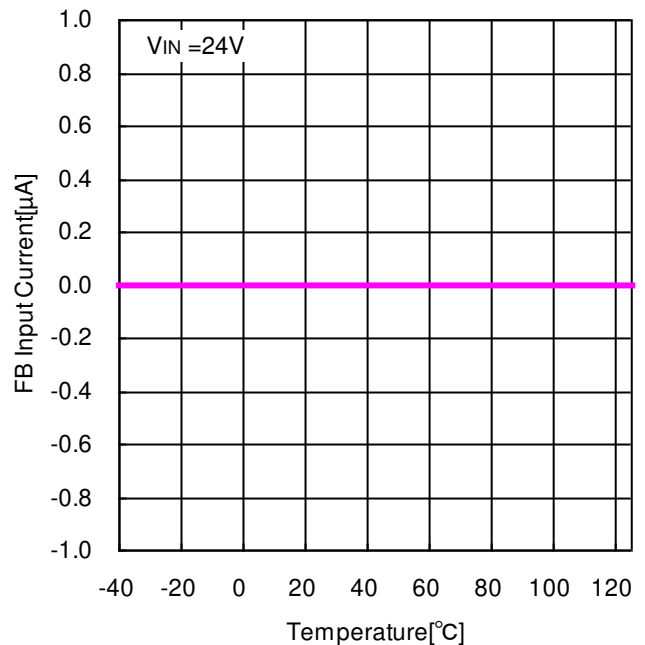

Figure 7. FB Input Current vs Junction Temperature

Typical Performance Curves - continued

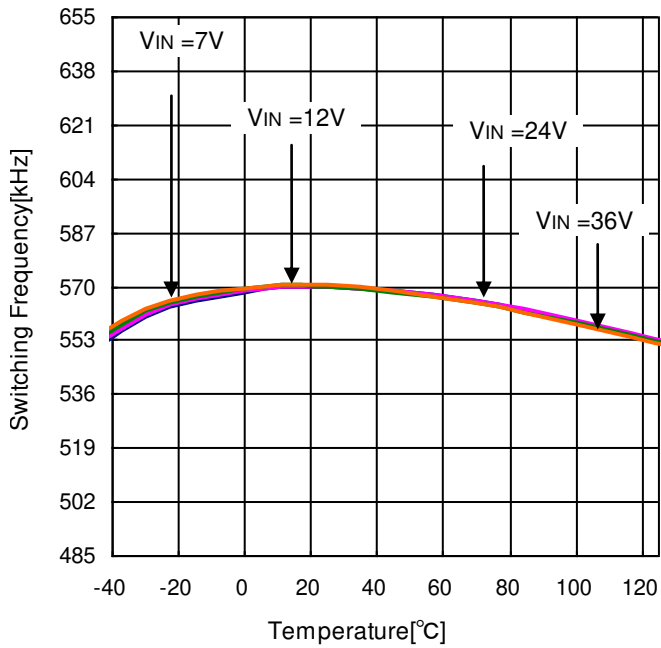

Figure 8. Switching Frequency vs Junction Temperature

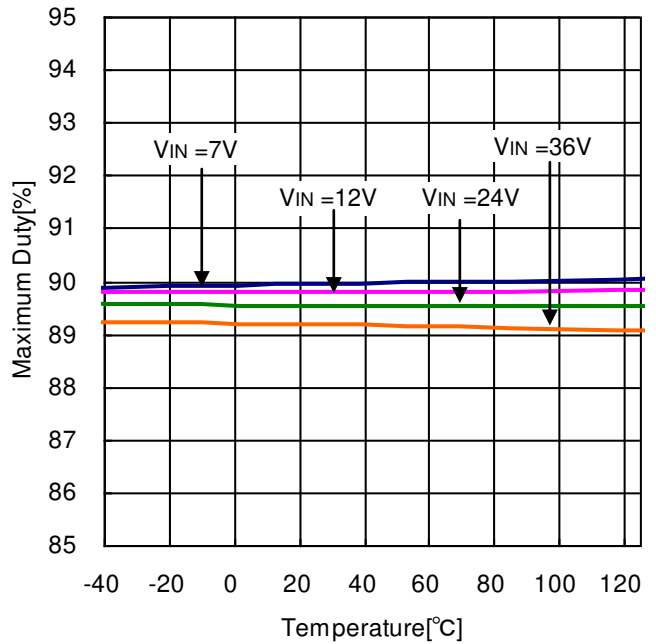

Figure 9. Maximum Duty vs Junction Temperature

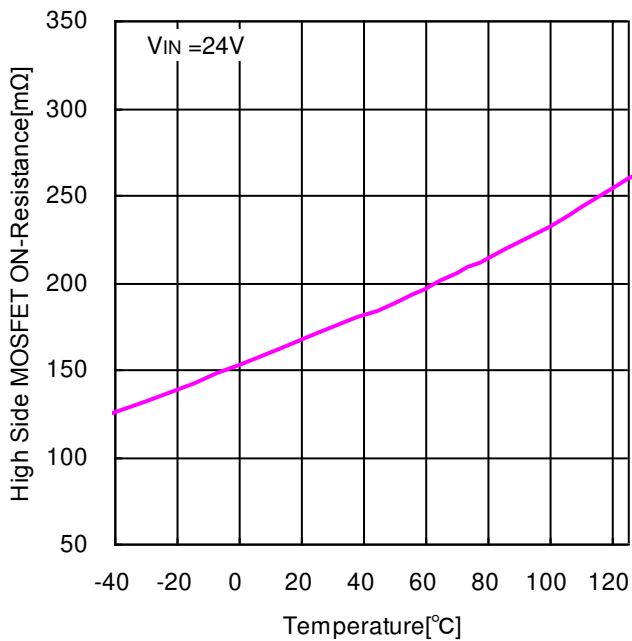

Figure 10. High Side MOSFET ON - Resistance vs Junction Temperature

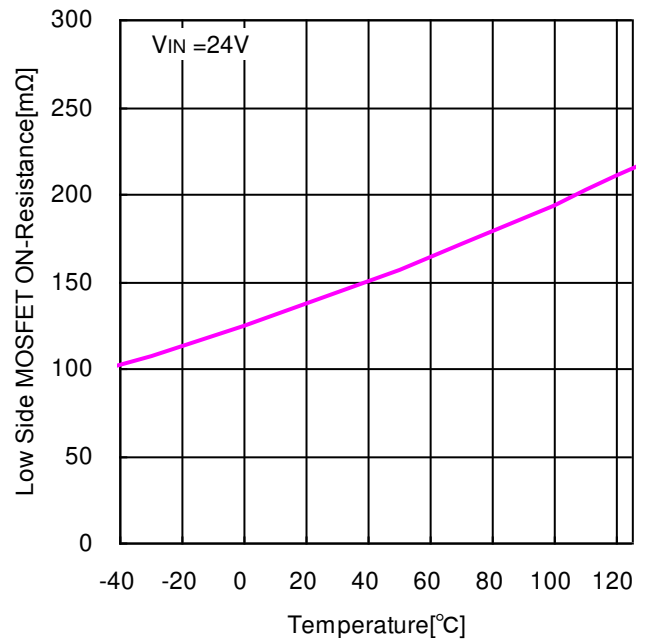

Figure 11. Low Side MOSFET ON -Resistance vs Junction Temperature



Typical Performance Curves - continued

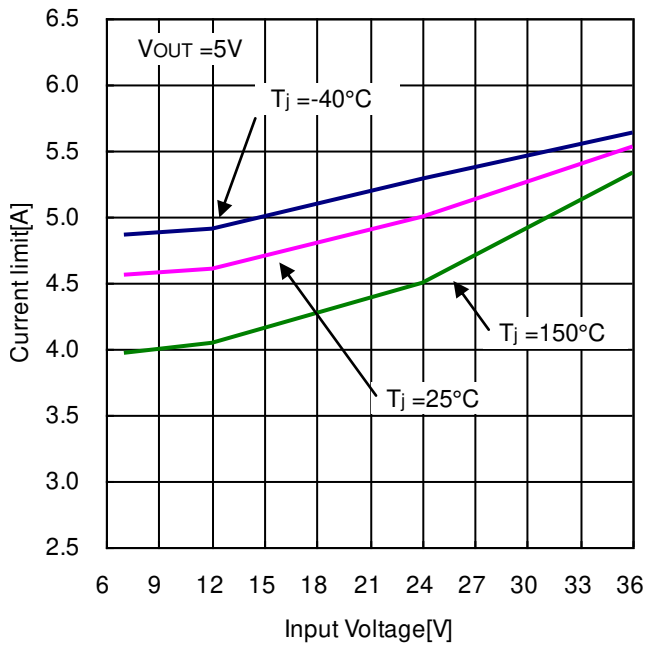

Figure 12. Current Limit vs Input Voltage

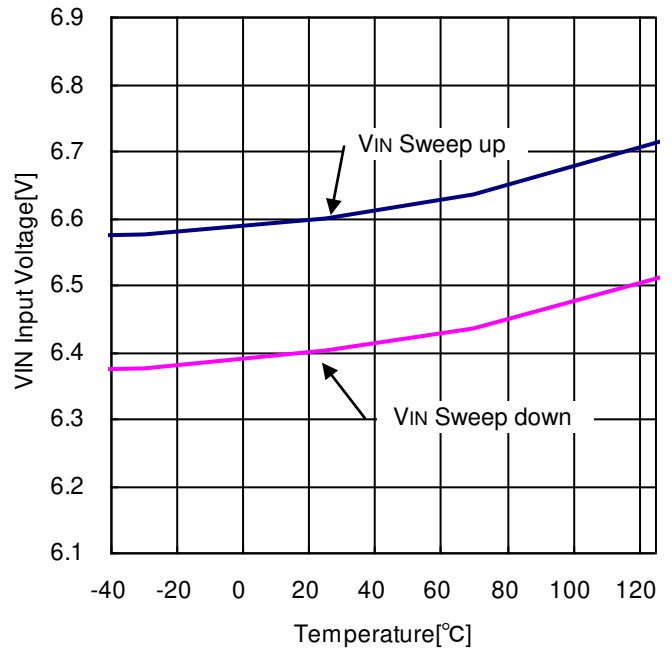

Figure 13. UVLO Threshold vs Junction Temperature

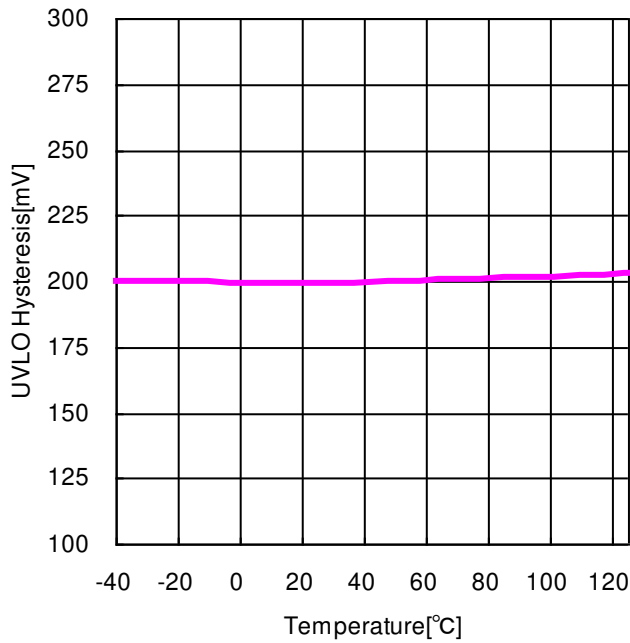

Figure 14. UVLO Hysteresis vs Junction Temperature

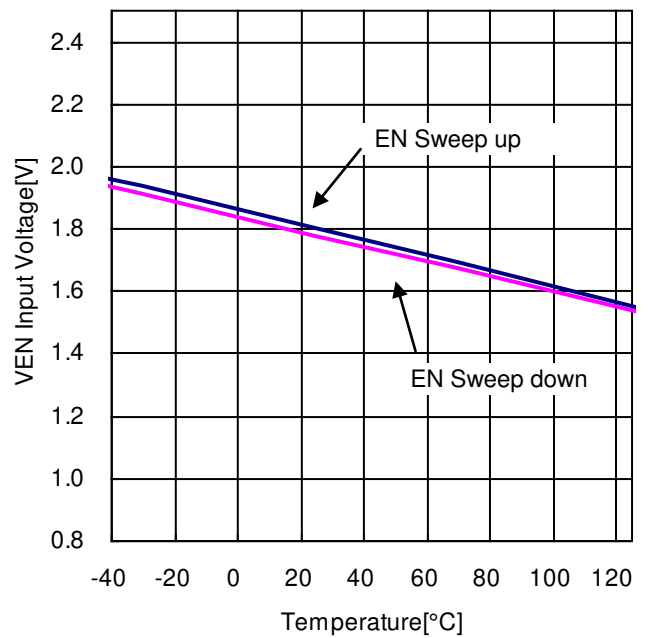

Figure 15. EN Threshold vs Junction Temperature

Typical Performance Curves - continued

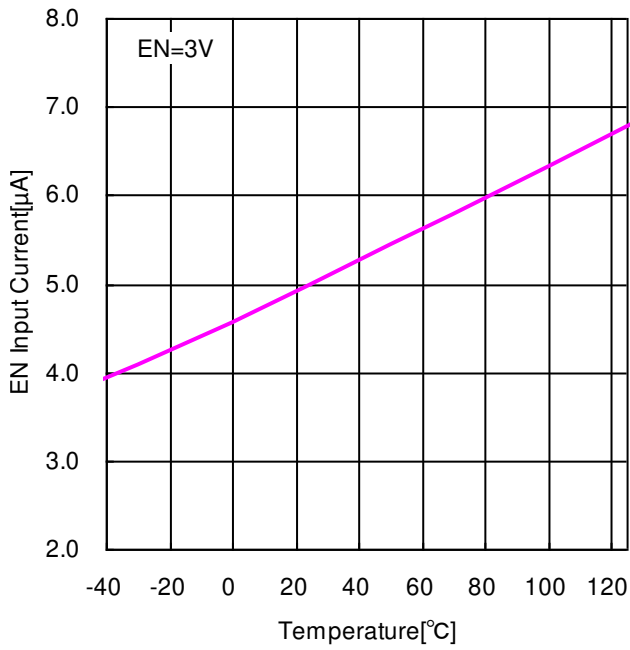

Figure 16. EN Input Current vs Junction Temperature

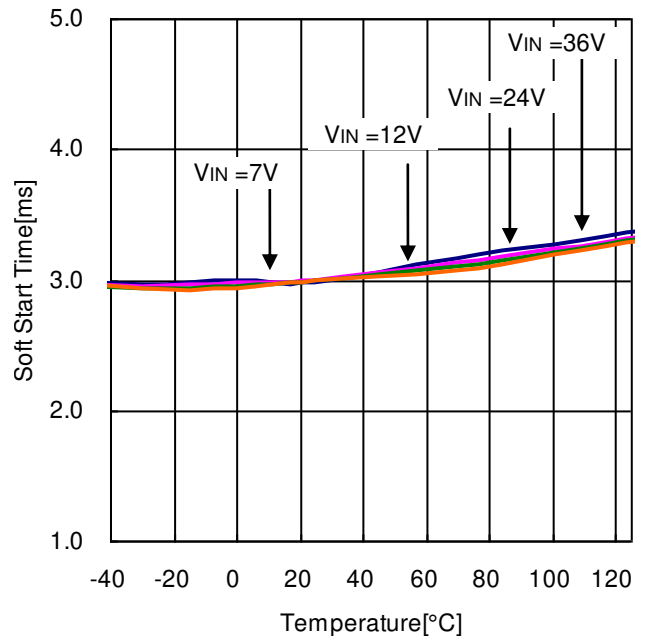

Figure 17. Soft Start Time vs Junction Temperature

Typical Performance Curves - continued

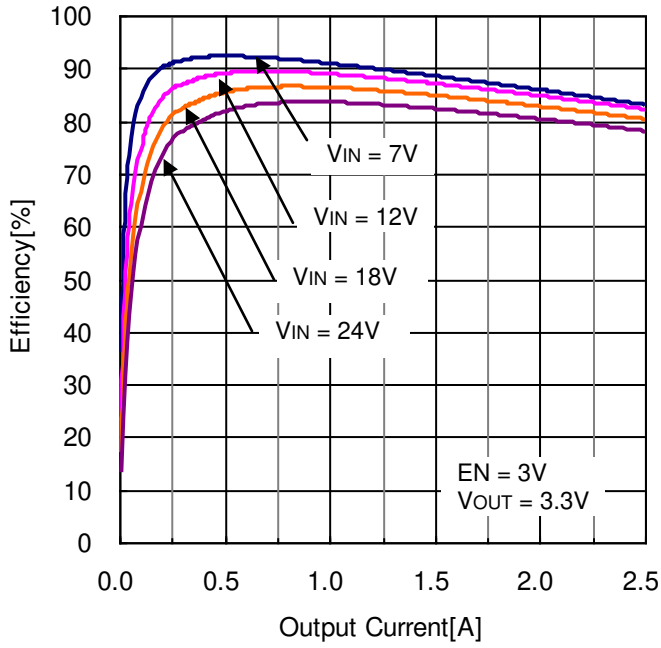

Figure 18. Efficiency vs Output Current (VOUT = 3.3V, L = 6.8μH)

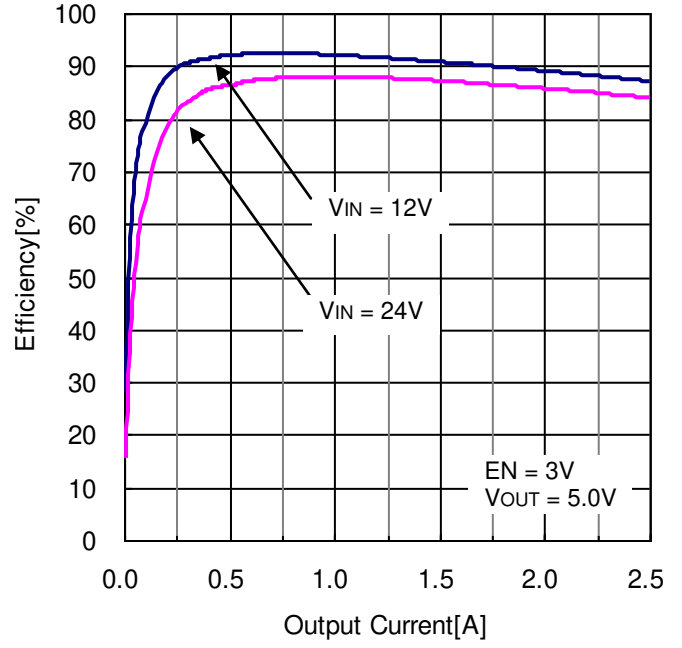

Figure 19. Efficiency vs Output Current (VOUT = 5.0V, L = 6.8μH)

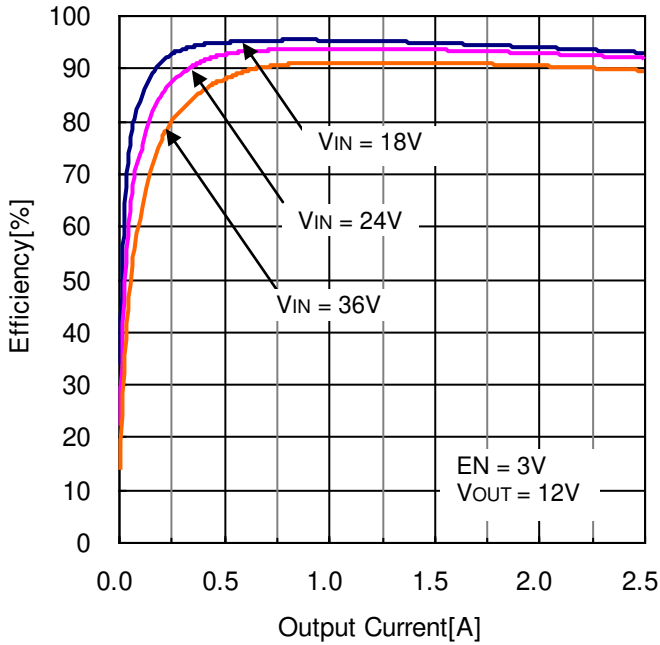

Figure 20. Efficiency vs Output Current (VOUT = 12V, L = 6.8μH)

Typical Performance Curves - continued

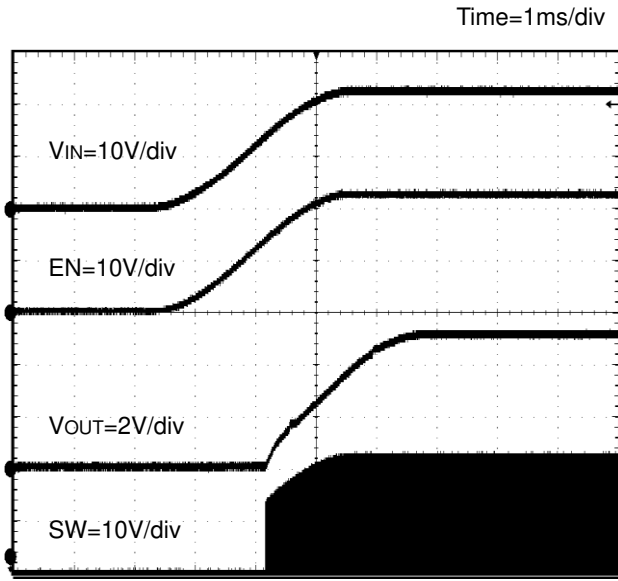

Figure 21. Power Up (VIN = EN)  
(VOUT = 5.0V)

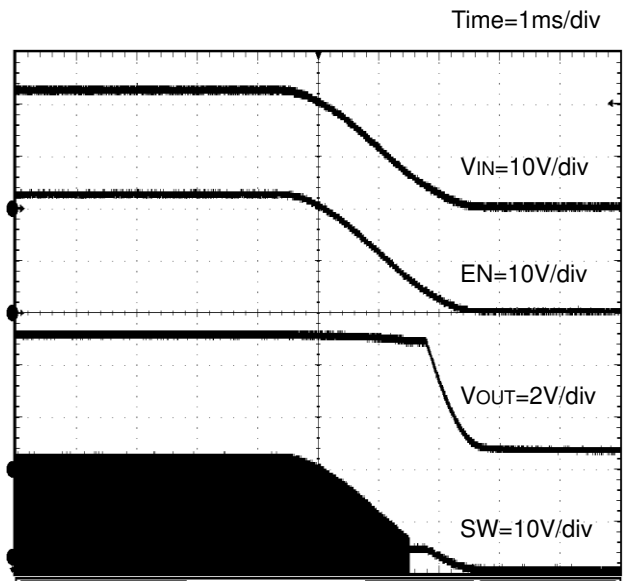

Figure 22. Power Down (VIN = EN)  
(VOUT = 5.0V)

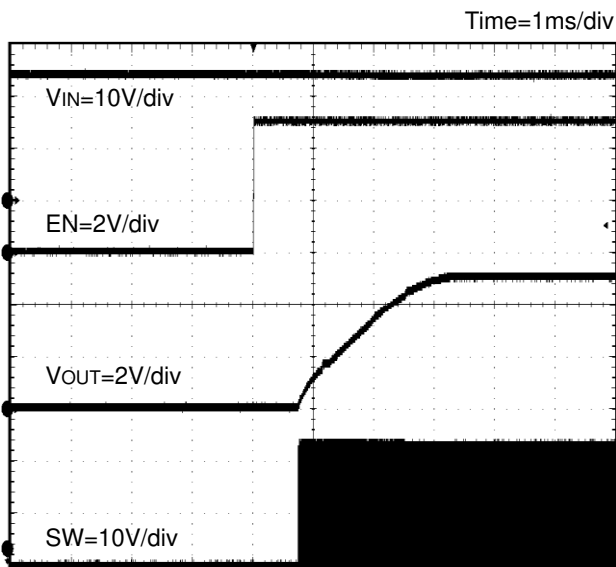

Figure 23. Power Up (EN = 0V→5V)  
(VOUT = 5.0V)

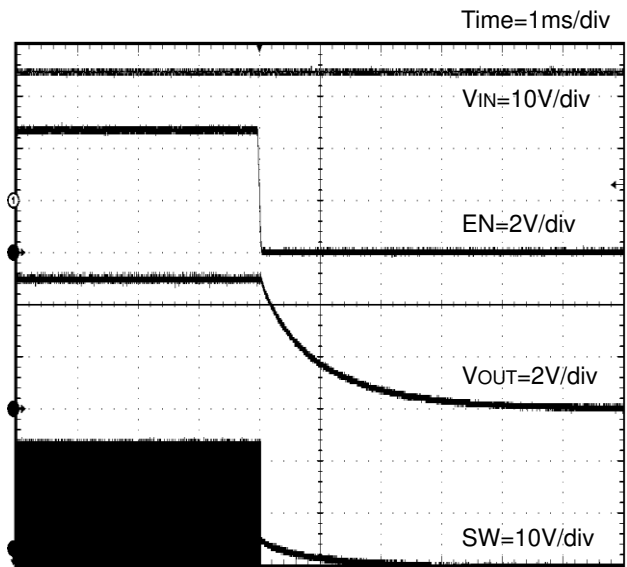

Figure 24. Power Down (EN = 5V→0V)  
(VOUT = 5.0V)

Typical Performance Curves - continued

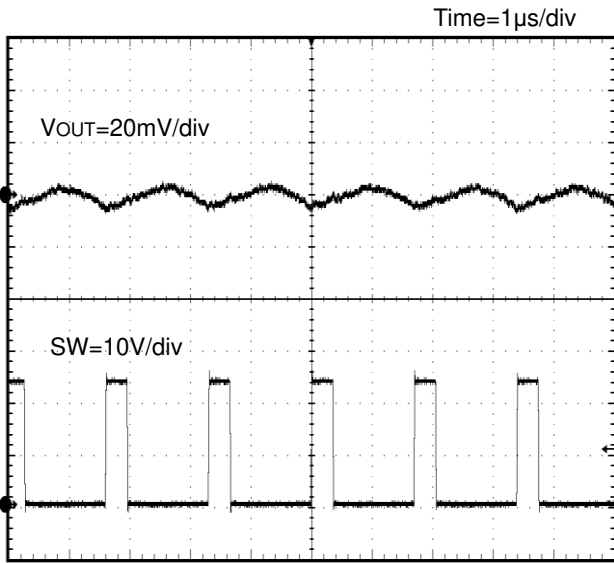

Figure 25. VOUT Ripple  
(VIN = 24V, VOUT = 5V, IOUT = 0A)

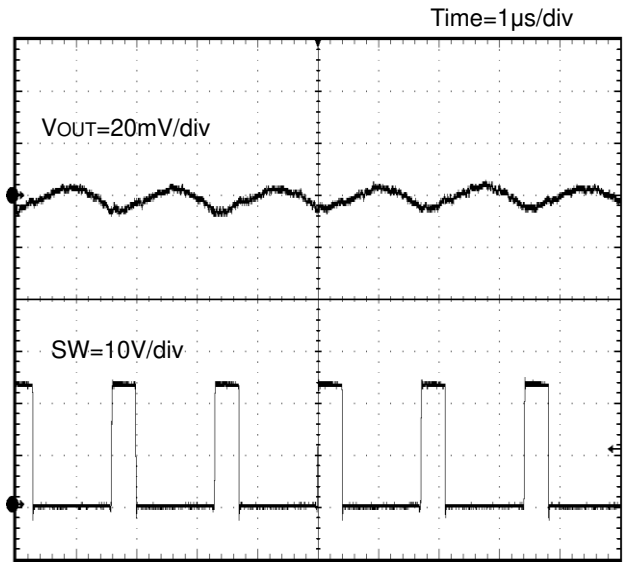

Figure 26. VOUT Ripple  
(VIN = 24V, VOUT = 5V, IOUT = 2.5A)

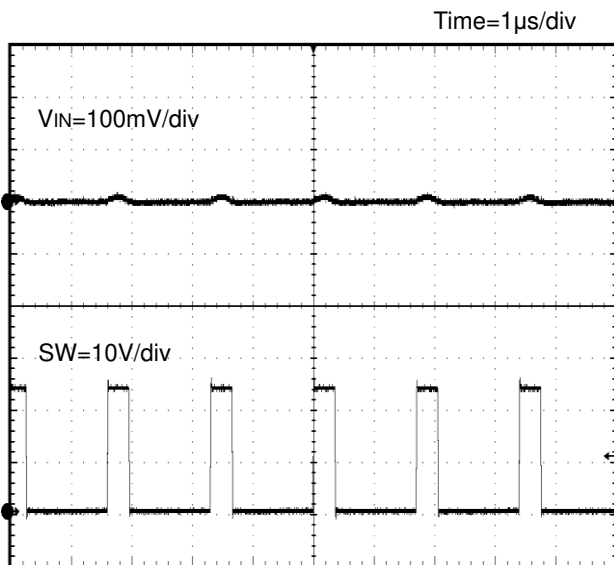

Figure 27. VIN Ripple  
(VIN = 24V, VOUT = 5V, IOUT = 0A)

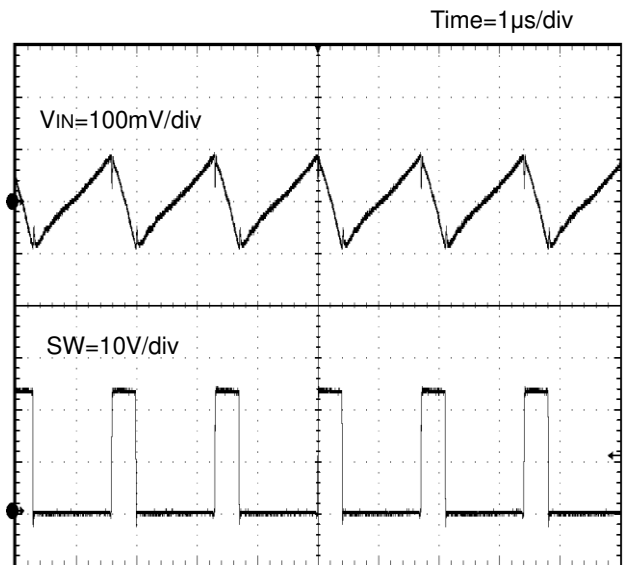

Figure 28. VIN Ripple  
(VIN = 24V, VOUT = 5V, IOUT = 2.5A)

Typical Performance Curves - continued

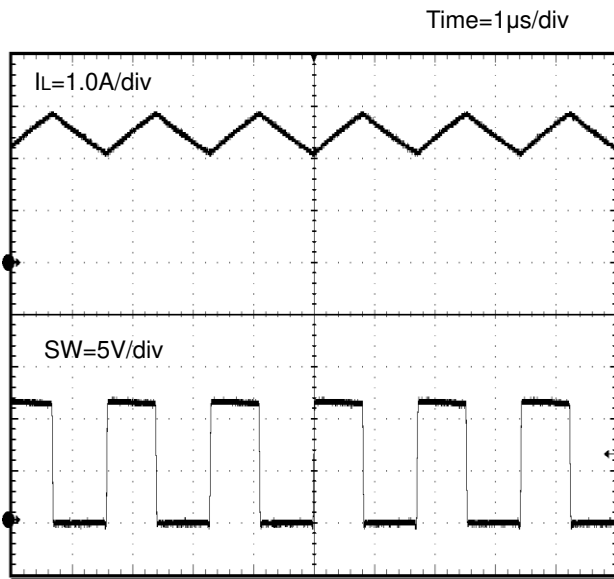

Figure 29. Switching Waveform  
( $V_{IN} = 12V$ ,  $V_{OUT} = 5V$ ,  $I_{OUT} = 2.5A$ )

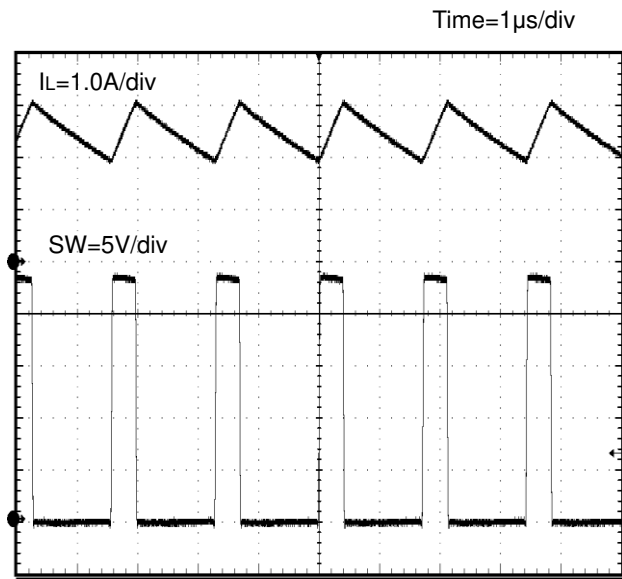

Figure 30. Switching Waveform  
( $V_{IN} = 24V$ ,  $V_{OUT} = 5V$ ,  $I_{OUT} = 2.5A$ )

Typical Performance Curves - continued

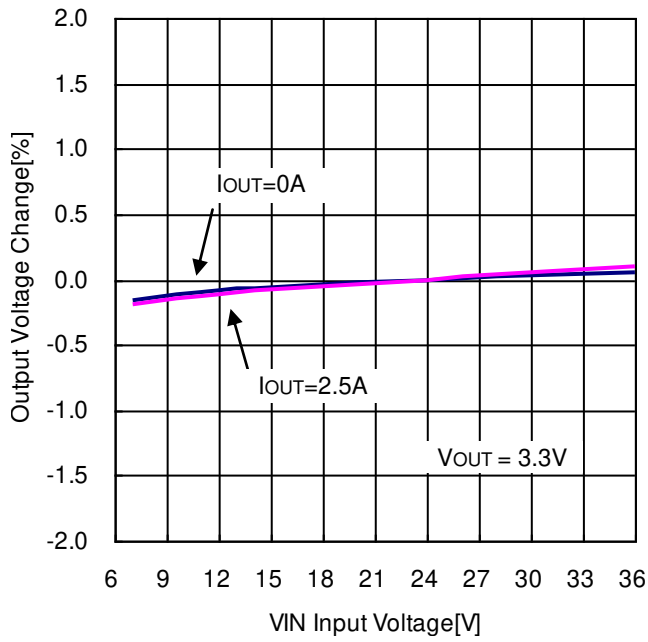

Figure 31. VOUT Line Regulation

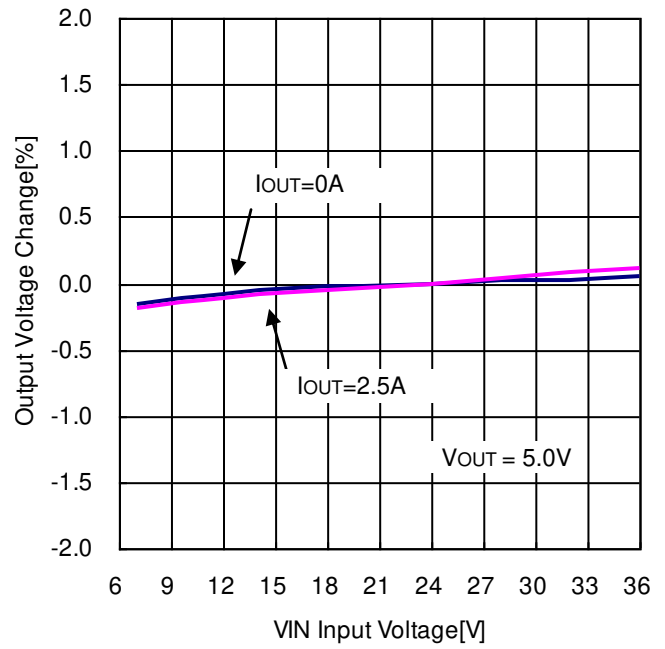

Figure 32. VOUT Line Regulation

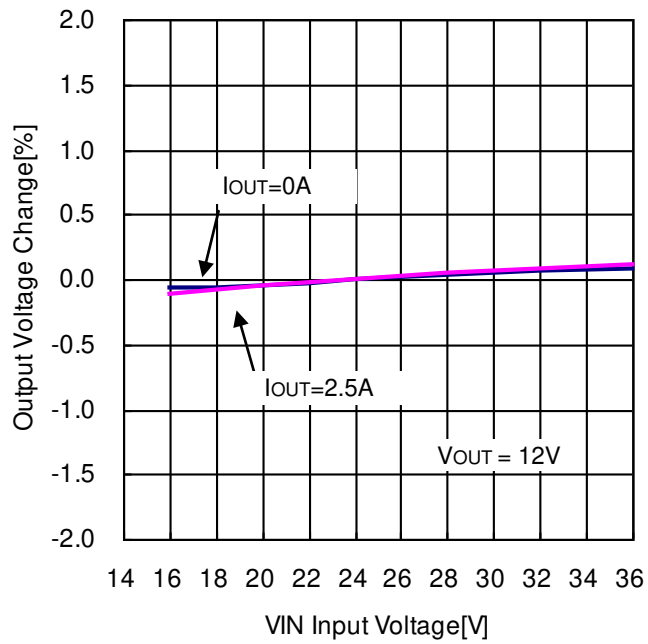

Figure 33. VOUT Line Regulation



Typical Performance Curves - continued

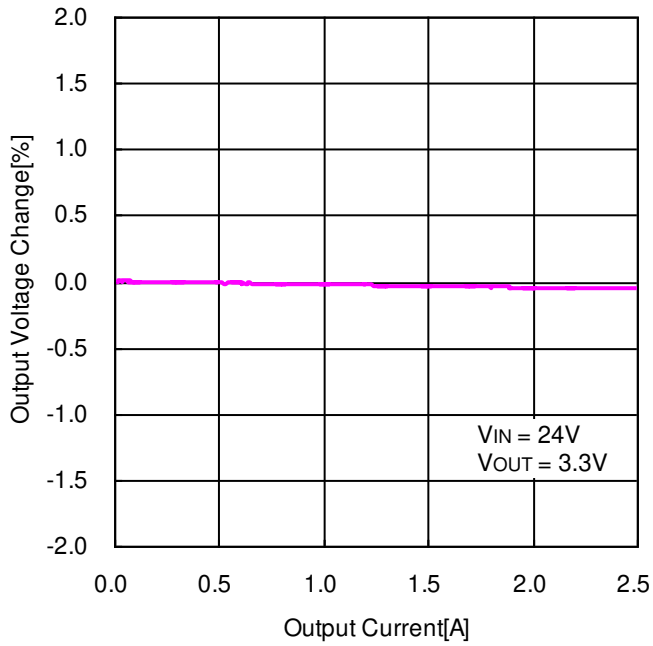

Figure 34. VOUT Load Regulation

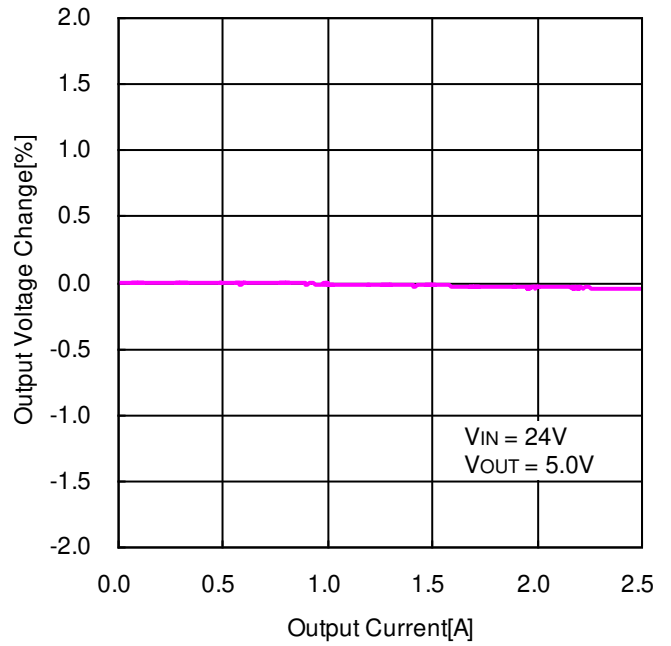

Figure 35. VOUT Load Regulation

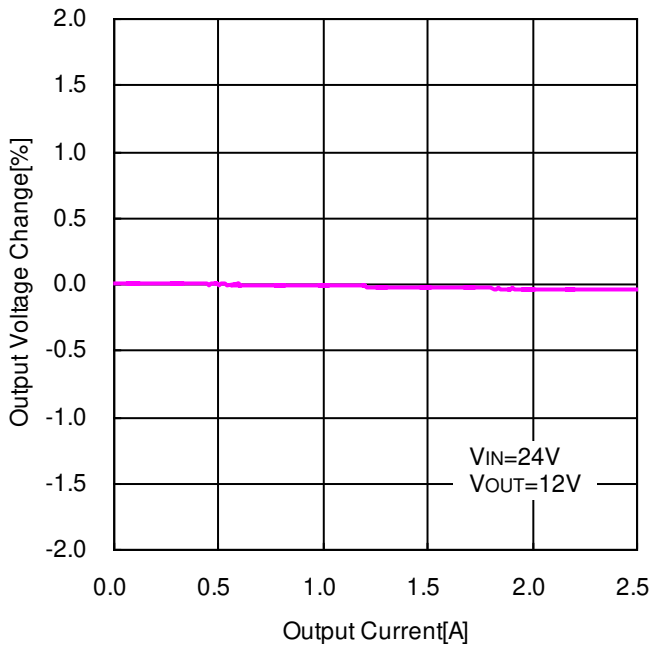

Figure 36. VOUT Load Regulation

Typical Performance Curves – continued

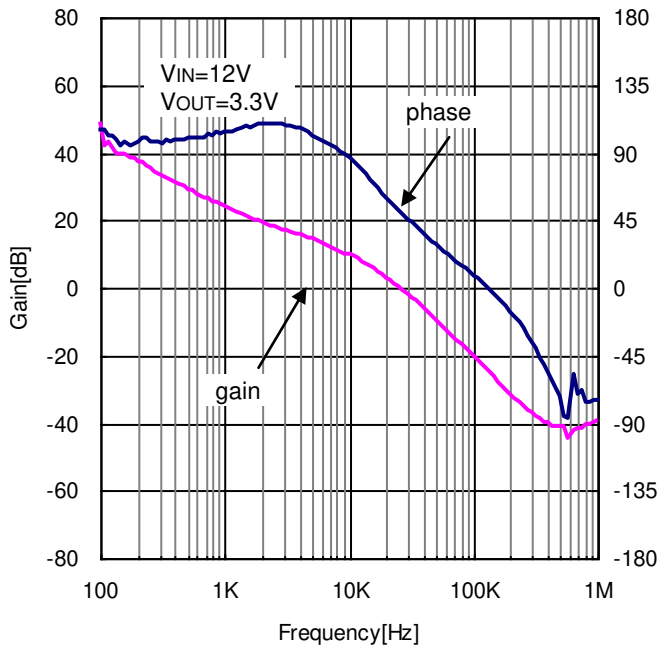

Figure 37. Loop Response  
(VIN=12V, VOUT=3.3V, IOUT=2.5A, COUT=Ceramic22μF × 2)

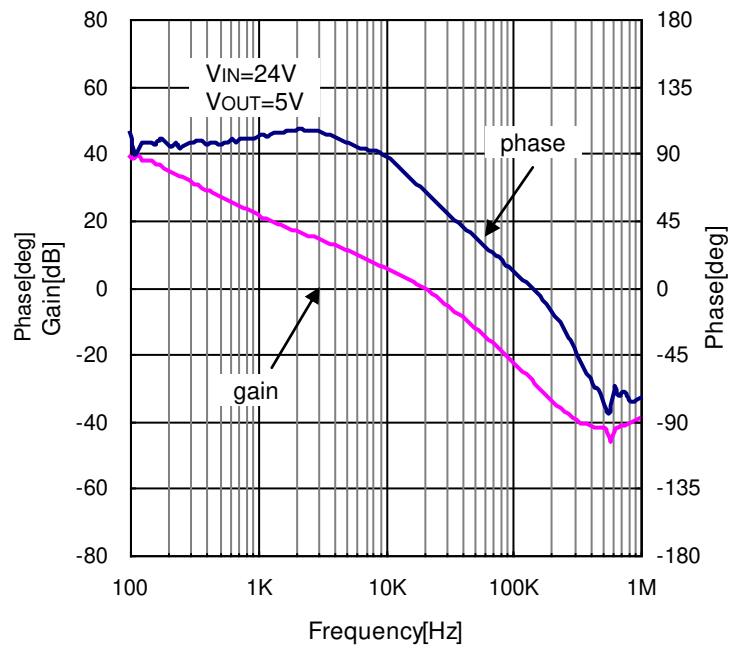

Figure 38. Loop Response  
(VIN=24V, VOUT=5V, IOUT=2.5A, COUT=Ceramic22μF × 2)

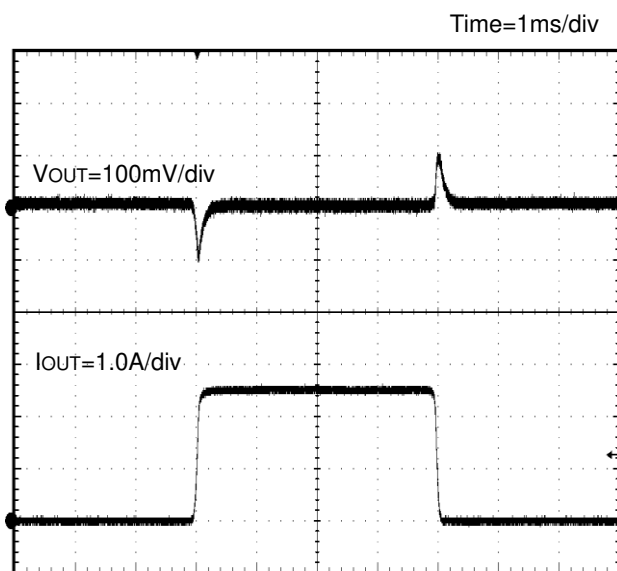

Figure 39. Load Transient Response IOUT=0A – 2.5A  
(VIN=12V, VOUT=3.3V, COUT=Ceramic22μF × 2)

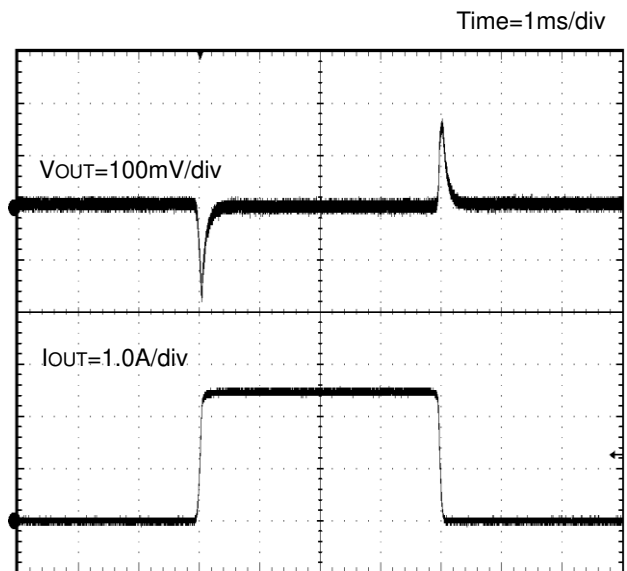

Figure 40. Load Transient Response IOUT=0A – 2.5A  
(VIN=24V, VOUT=5.0V, COUT=Ceramic22μF × 2)

Function Description

1. Enable Control

The IC shutdown can be controlled by the voltage applied to the EN terminal. When EN voltage reaches 2.5V (Typ), the internal circuit is activated and the IC starts up. Setting the shutdown interval (Low Level interval) of EN to 100µs or longer will enable the shutdown control with the EN terminal.

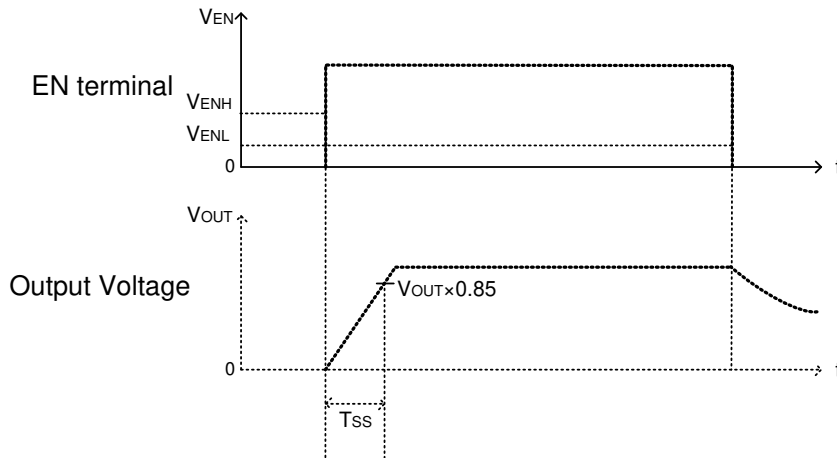

Figure 41. Timing Chart with Enable Control

2. Protective Functions

The protective circuits are intended for the prevention of damages caused by unexpected accidents. Do not use them for continuous protective operation.

(1) Short Circuit Protection (SCP)

The short circuit protection block compares the FB terminal voltage with the internal reference voltage VREF. When the FB terminal voltage has fallen below 0.85V (Typ) and remained in that state for 1.0msec (Typ), SCP activates and stops the operation for 16msec (Typ) and subsequently initiates a restart.

Table 1. Short Circuit Protection Function

EN pin	FB pin	Short circuit protection	Switching Frequency
2.5V or higher	$0.30V (Typ) \geq FB$	Enabled	142.5kHz (Typ)
	$0.30V (Typ) > B \geq 0.85V (Typ)$		285kHz (Typ)
	$FB > 0.85V (Typ)$		570kHz (Typ)
0.8V or lower	-	Disabled	OFF

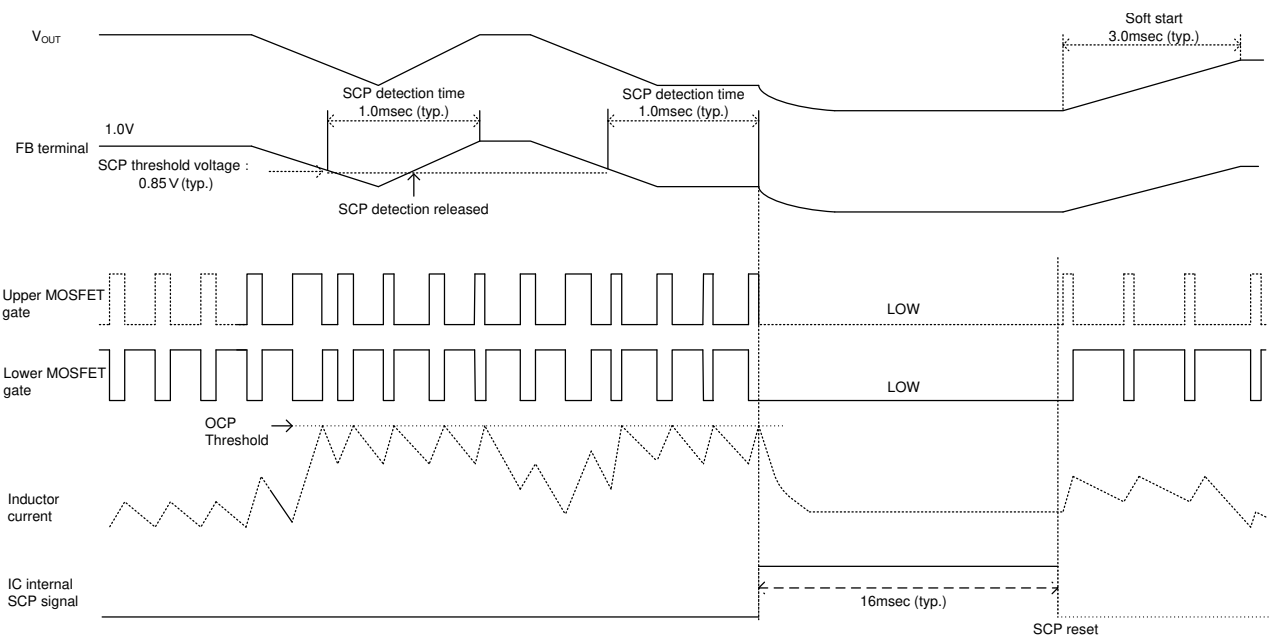

Figure 42. Short Circuit Protection (SCP) Timing Chart

**(2) Under Voltage Lockout Protection (UVLO)**

The under voltage lockout protection circuit monitors the VIN terminal voltage. The operation enters standby when the VIN terminal voltage is 6.4V (Typ) or lower. The operation starts when the VIN terminal voltage is 6.6V (Typ) or higher.

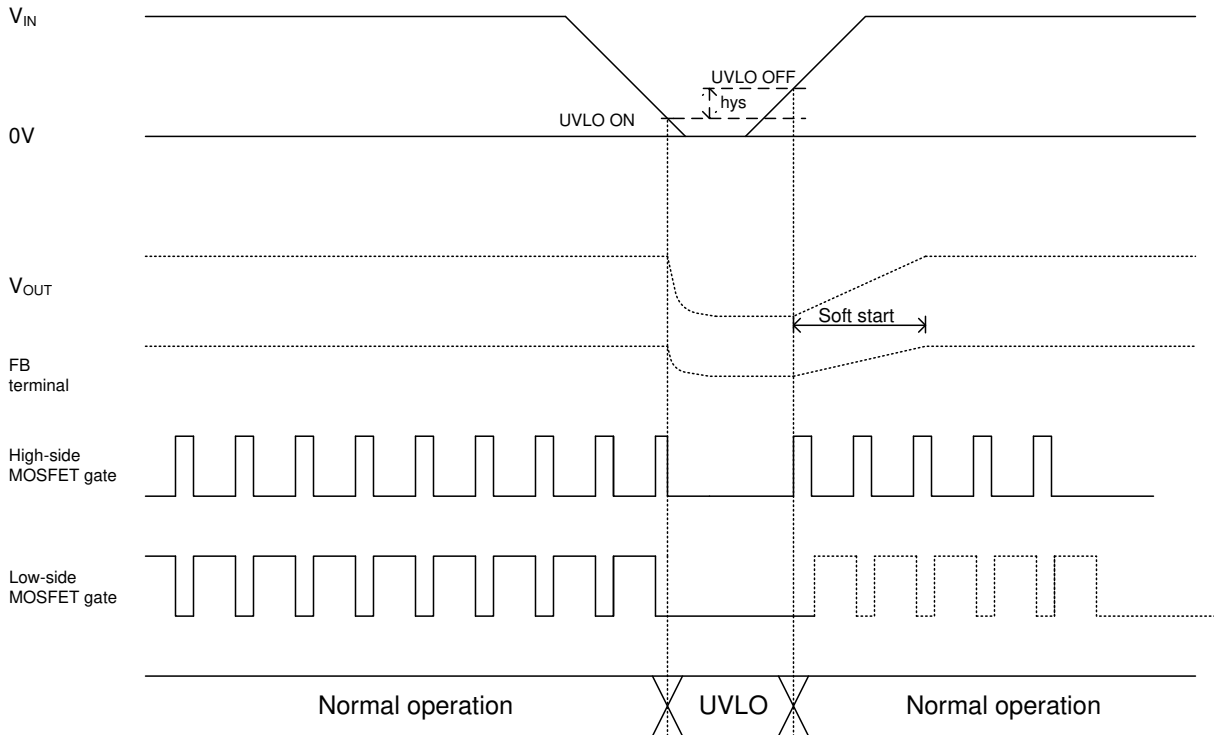

Figure 43. UVLO Timing Chart

**(3) Thermal Shutdown (TSD)**

When the chip temperature exceeds  $T_j = 175^{\circ}\text{C}$ , the DC/DC converter output is stopped. The thermal shutdown circuit is intended for shutting down the IC from thermal runaway in an abnormal state with the temperature exceeding  $T_{jmax} = 150^{\circ}\text{C}$ . It is not meant to protect or guarantee the soundness of the application. Do not use the function of this circuit for application protection design.

**(4) Over Current Protection (OCP)**

The over-current protection function is realized by using the current mode control to limit the current that flows through the high-side MOSFET at each cycle of the switching frequency.

**(5) Reverse Current Protection (RCP)**

The reverse current protection function is realized by using the current mode control to limit the current that flows through the low-side MOSFET at each cycle of the switching frequency.

**(6) Over Voltage Protection (OVP)**

Over voltage protection function (OVP) compares FB terminal voltage with internal standard voltage  $V_{REF}$ . When the FB terminal voltage exceeds 1.30V (Typ), it turns output MOSFETs off. When output voltage drops until it reaches the hysteresis, it will return to normal operation.

Application Example

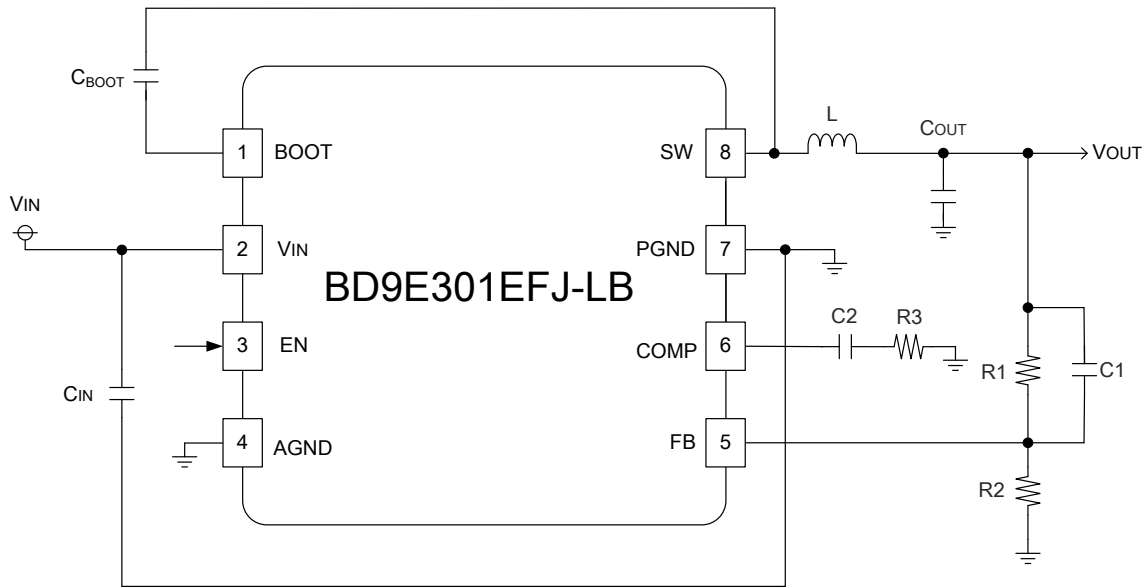

Figure 44. Application Circuit

Table 2. Recommendation Component Values

VIN	12V			24V		
VOUT	3.3V			5V		
CIN	10µF	10µF	10µF	10µF	10µF	10µF
CBOOT	0.1µF	0.1µF	0.1µF	0.1µF	0.1µF	0.1µF
L	4.7µH	4.7µH	4.7µH	6.8µH	6.8µH	6.8µH
R1	6.8kΩ	6.8kΩ	6.8kΩ	12kΩ	12kΩ	12kΩ
R2	3.0kΩ	3.0kΩ	3.0kΩ	3.0kΩ	3.0kΩ	3.0kΩ
R3	6.8kΩ	6.8kΩ	6.8kΩ	15kΩ	15kΩ	15kΩ
C1	-	-	-	-	-	-
C2	6800pF	6800pF	6800pF	4700pF	4700pF	4700pF
COUT	Ceramic 22µF×2	Ceramic 10µF×3	Ceramic 10µF and Aluminum 100µF	Ceramic 22µF×2	Ceramic 10µF×3	Ceramic 10µF and Aluminum 100µF

Selection of Components Externally Connected

1. Output LC Filter

The DC/DC converter requires an LC filter for smoothing the output voltage in order to supply a continuous current to the load. Selecting an inductor with a large inductance causes the ripple current  $\Delta I_L$  that flows into the inductor to be small, decreasing the ripple voltage generated in the output voltage, but it is not advantageous in terms of the load transient response characteristic. Selecting an inductor with a small inductance improves the transient response characteristic but causes the inductor ripple current to be large, which increases the ripple voltage in the output voltage, showing a trade-off relationship. Here, select an inductance so that the size of the ripple current component of the inductor will be 20% to 50% of the average output current (average inductor current).

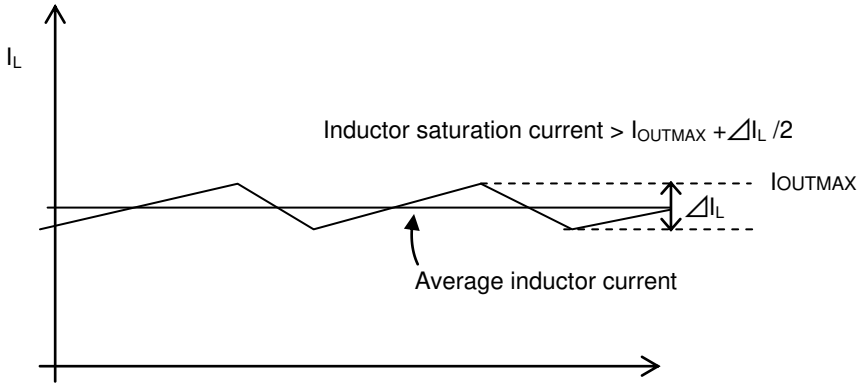

Figure 45. Waveform of current through inductor

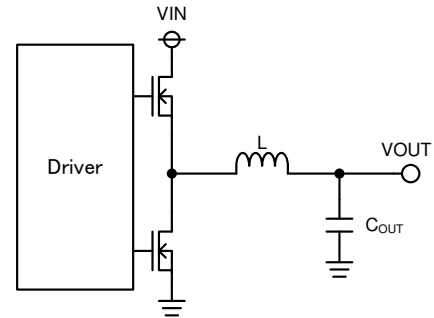

Figure 46. Output LC filter circuit

Computation with  $V_{IN} = 24V$ ,  $V_{OUT} = 5V$ ,  $L = 6.8\mu H$ , switching frequency  $F_{OSC} = 570kHz$ , the method is as below.

Inductor ripple current

$$\Delta I_L = V_{OUT} \times (V_{IN} - V_{OUT}) \times \frac{1}{V_{IN} \times F_{OSC} \times L} = 1.0 \text{ [A]}$$

where :

$\Delta I_L$  is the inductor ripple current

$F_{OSC}$  is the swithing frequency

$L$  is the inductor

$V_{IN}$  is the input voltage

$V_{OUT}$  is the output voltage

Also for saturation current of inductor, select the one with larger current than maximum output current added by 1/2 of inductor ripple current  $\Delta I_L$ .

Output capacitor  $C_{OUT}$  affects output ripple voltage characteristics. Select output capacitor  $C_{OUT}$  so that necessary ripple voltage characteristics are satisfied.

Output ripple voltage can be expressed in the following method.

$$\Delta V_{RPL} = \Delta I_L \times (R_{ESR} + \frac{1}{8 \times C_{OUT} \times F_{OSC}}) \text{ [V]}$$

where :

$\Delta V_{RPL}$  is the output ripple voltage

$R_{ESR}$  is the serial equivalent series resistance

$C_{OUT}$  is the output capacitor

With  $C_{OUT} = 44\mu F$ ,  $RESR = 10m\Omega$  the output ripple voltage is calculated as

$$\Delta V_{RPL} = 1.0 \times \left( 10m + \frac{1}{8 \times 44\mu \times 570k} \right) = 15 \text{ [mV]}$$

\* When selecting the value of the output capacitor C<sub>OUT</sub>, please note that the value of capacitor C<sub>LOAD</sub> will add up to the value of C<sub>OUT</sub> to be connected to V<sub>OUT</sub>.  
Charging current to flow through the C<sub>LOAD</sub>, C<sub>OUT</sub> and the IC startup, must be completed within the soft-start time this charge. Over-current protection circuit operates when charging is continued beyond the soft-start time, the IC may not start. Please consider in the calculation the condition that the lower maximum value capacitor C<sub>LOAD</sub> that can be connected to V<sub>OUT</sub> (max) is other than C<sub>OUT</sub>.

Inductor ripple current maximum value of start-up (I<sub>LSTART</sub>) < Over Current Protection Threshold 3.8 [A](min)

Inductor ripple current maximum value of start-up (I<sub>LSTART</sub>) can be expressed in the following method.

$$I_{LSTART} = \text{Output maximum load current}(I_{OMAX}) + \text{Charging current to the output capacitor} (I_{CAP}) + \frac{\Delta I_L}{2} \text{ [mV]}$$

Charging current to the output capacitor (I<sub>CAP</sub>) can be expressed in the following method.

$$I_{CAP} = \frac{(C_{OUT} + C_{LOAD}) \times V_{OUT}}{T_{SS}} \text{ [A]}$$

where :

C<sub>OUT</sub> is the output capacitance

C<sub>LOAD</sub> is the output load capacitance

T<sub>SS</sub> is the soft start time

From the above equation, V<sub>IN</sub> = 24V, V<sub>OUT</sub> = 5V, L = 4.7μH, I<sub>OMAX</sub> = 2.5A (max), switching frequency F<sub>OSC</sub> = 484kHz (min), the output capacitor C<sub>OUT</sub> = 44μF, T<sub>SS</sub> = 1.5ms soft-start time (min), it becomes the following equation when calculating the maximum output load capacitance C<sub>LOAD</sub> (max) that can be connected to V<sub>OUT</sub>.

$$C_{LOAD}(max) < \frac{(3.8 - I_{OMAX} - \Delta I_L/2) \times T_{SS}}{V_{OUT}} - C_{OUT} = 165 \text{ [}\mu\text{F]}$$



**2. Output Voltage Set Point**

The output voltage value can be set by the feedback resistance ratio.

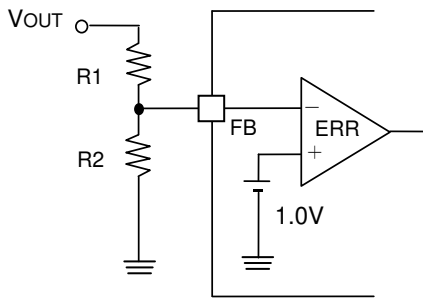

$$V_{OUT} = \frac{R_1 + R_2}{R_2} \times 1.0 \text{ [V]}$$

※ Minimum pulse range that can be produced at the output stably through all the load area is 150nsec for BD9E301EFJ-LB.  
Use input/output condition which satisfies the following method.

$$150(nsec) \leq \frac{V_{OUT}}{V_{IN} \times F_{OSC}}$$

Figure 47. Feedback Resistor Circuit

**3. Input voltage start-up**

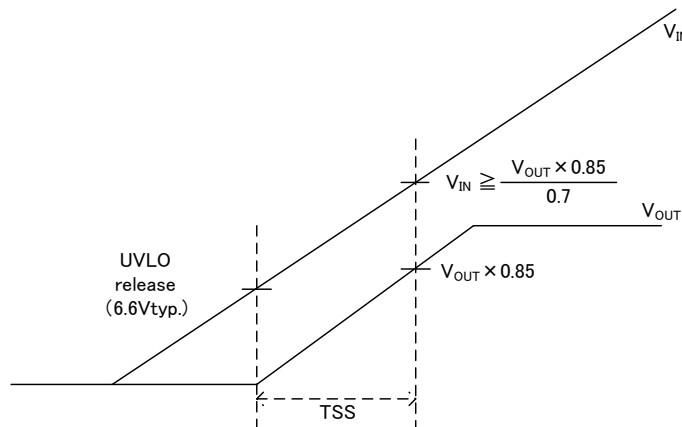

Figure 48. Input Voltage Start-up Time

Soft-start function is designed for the IC so that the output voltage will start according to the time it was decided internally. After UVLO release, the output voltage range will be less than 70% of the input voltage at soft-start operation. Please be sure that the input voltage of the soft-start after startup is as follows.

$$V_{IN} \geq \frac{V_{OUT} \times 0.85}{0.7} \text{ [V]}$$

4. Phase Compensation

A current mode control buck DC/DC converter is a two-pole, one-zero system. The two poles are formed by an error amplifier and load and the one zero point is added by the phase compensation. The phase compensation resistor  $R_{CMP}$  determines the crossover frequency  $F_{CRS}$  where the total loop gain of the DC/DC converter is 0 dB. The high value of this crossover frequency  $F_{CRS}$  provides a good load transient response characteristic but inferior stability. Conversely, specifying a low value for the crossover frequency  $F_{CRS}$  greatly stabilizes the characteristics but the load transient response characteristic is impaired.

(1) Selection of Phase Compensation Resistor  $R_{CMP}$

The phase compensation resistance  $R_{CMP}$  can be determined by using the following equation.

$$R_{CMP} = \frac{2\pi \times V_{OUT} \times F_{CRS} \times C_{OUT}}{V_{FB} \times G_{MP} \times G_{MA}} [\Omega]$$

where :

$V_{OUT}$  is the output voltage

$F_{CRS}$  is the crossover frequency

$C_{OUT}$  is the output capacitance

$V_{FB}$  is the feedback reference voltage (1.0 V (Typ))

$G_{MP}$  is the current sense gain (7 A/V (Typ))

$G_{MA}$  is the error amplifier transconductance (150  $\mu$ A/V (Typ))

(2) Selection of phase compensation capacitance  $C_{CMP}$

For stable operation of the DC/DC converter, inserting a zero point under 1/6 of the zero crossover frequency cancels the phase delay due to the pole formed by the load often, thus, providing favorable characteristics.

The phase compensation capacitance  $C_{CMP}$  can be determined by using the following equation.

$$C_{CMP} = \frac{1}{2\pi \times R_{CMP} \times F_Z} [F]$$

where

$F_Z$  is the Zero point inserted

(3) Loop stability

To ensure the stability of the DC/DC converter, make sure that a sufficient phase margin is provided. Phase margin of at least 45 degrees in the worst conditions is recommended. The feed forward capacitor  $C_{RUP}$  is used for the purpose of forming a zero point together with the resistor  $R_{UP}$  to increase the phase margin within the limited frequency range. Using a  $C_{RUP}$  is effective when the  $R_{UP}$  resistance is larger than the combined parallel resistance of  $R_{UP}$  and  $R_{DW}$ .

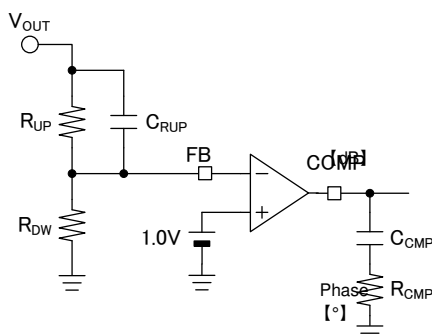

Figure 49. Phase compensation circuit

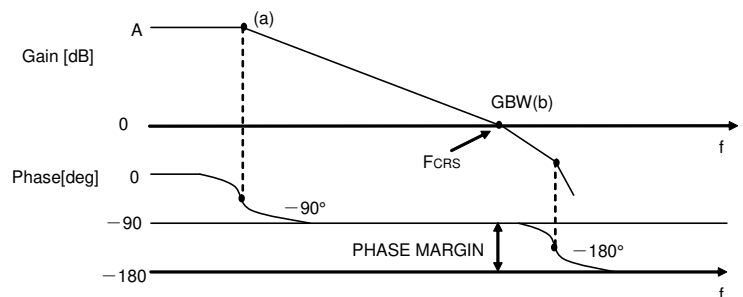

Figure 50. Bode plot

PCB Layout Design

In buck DC/DC converters, a large pulsed current flows in two loops. The first loop is the one into which the current flows when the High Side FET is turned on. The flow starts from the input capacitor  $C_{IN}$ , runs through the FET, inductor  $L$  and output capacitor  $C_{OUT}$  and back to ground of  $C_{IN}$  via ground of  $C_{OUT}$ . The second loop is the one into which the current flows when the Low Side FET is turned on. The flow starts from the Low Side FET, runs through the inductor  $L$  and output capacitor  $C_{OUT}$  and back to ground of the Low Side FET via ground of  $C_{OUT}$ . Tracing these two loops as thick and short as possible allows noise to be reduced for improved efficiency. It is recommended to connect the input and output capacitors, in particular, to the ground plane. The PCB layout has a great influence on the DC/DC converter in terms of all of the heat generation, noise and efficiency characteristics.

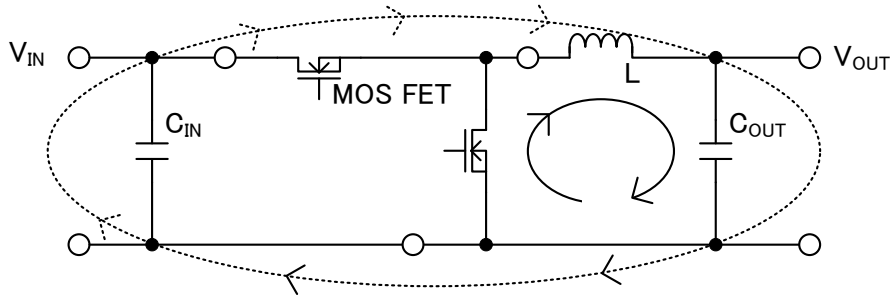
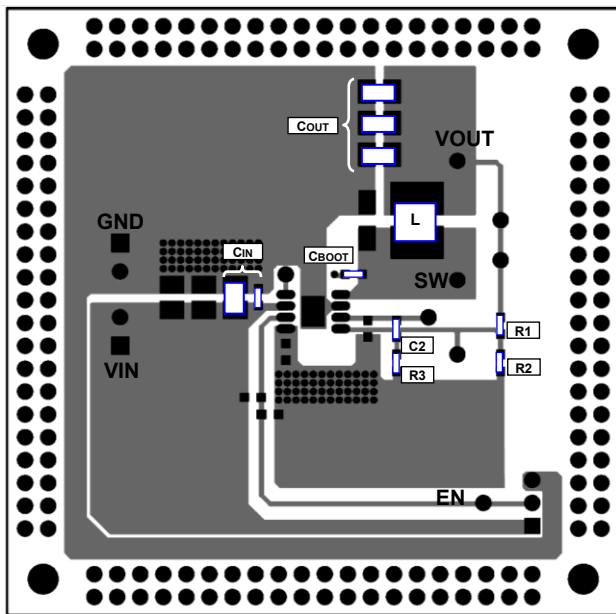

Figure 51. Current Loop of Buck Converter

Accordingly, design the PCB layout with particular attention paid to the following points.

- Provide the input capacitor as close to the VIN terminal as possible on the same plane as the IC.
- If there is any unused area on the PCB, provide a copper foil plane for the ground node to assist in heat dissipation from the IC and the surrounding components.
- Switching nodes such as SW are susceptible to noise due to AC coupling with other nodes. Trace to the inductor as thick and as short as possible.
- Provide lines connected to FB and COMP as far as possible from the SW node.
- Provide the output capacitor away from the input capacitor in order to avoid the effect of harmonic noise from the input.



Top Layer

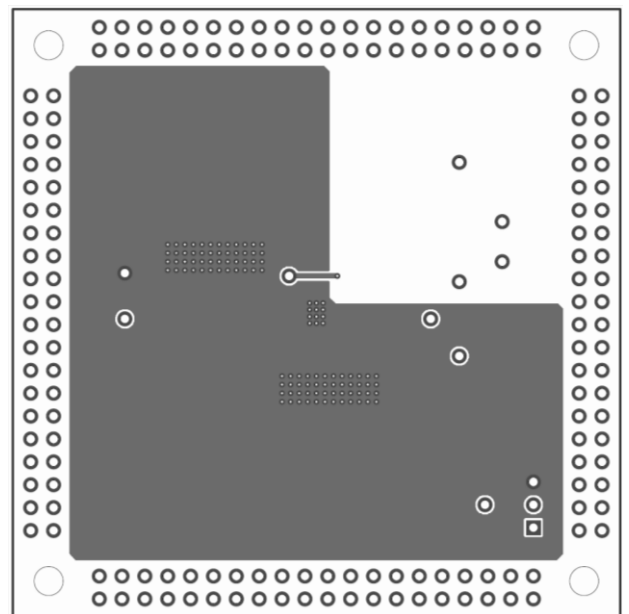

Bottom Layer

Figure 52. Example of Sample Board Layout Pattern

Power Dissipation

When designing the PCB layout and peripheral circuitry, sufficient consideration must be given to ensure that the power dissipation is within the allowable dissipation curve.

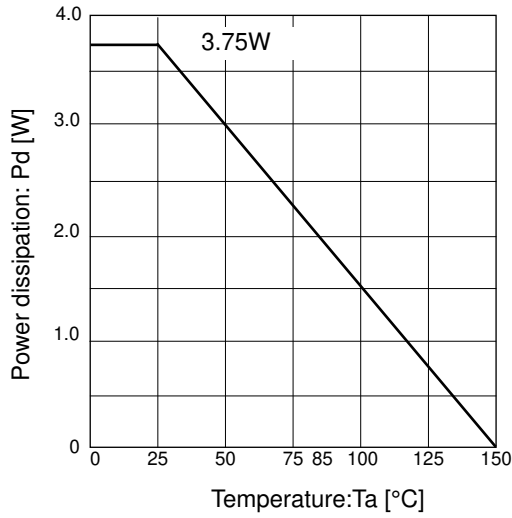

$\theta_{JA}=33.3^{\circ}\text{C}/\text{W}$   
 4 layer board  
 (back side copper foil area:70mm × 70mm)

Figure 53. Power Dissipation (HTSOP-J8)

I/O equivalence circuit(s)

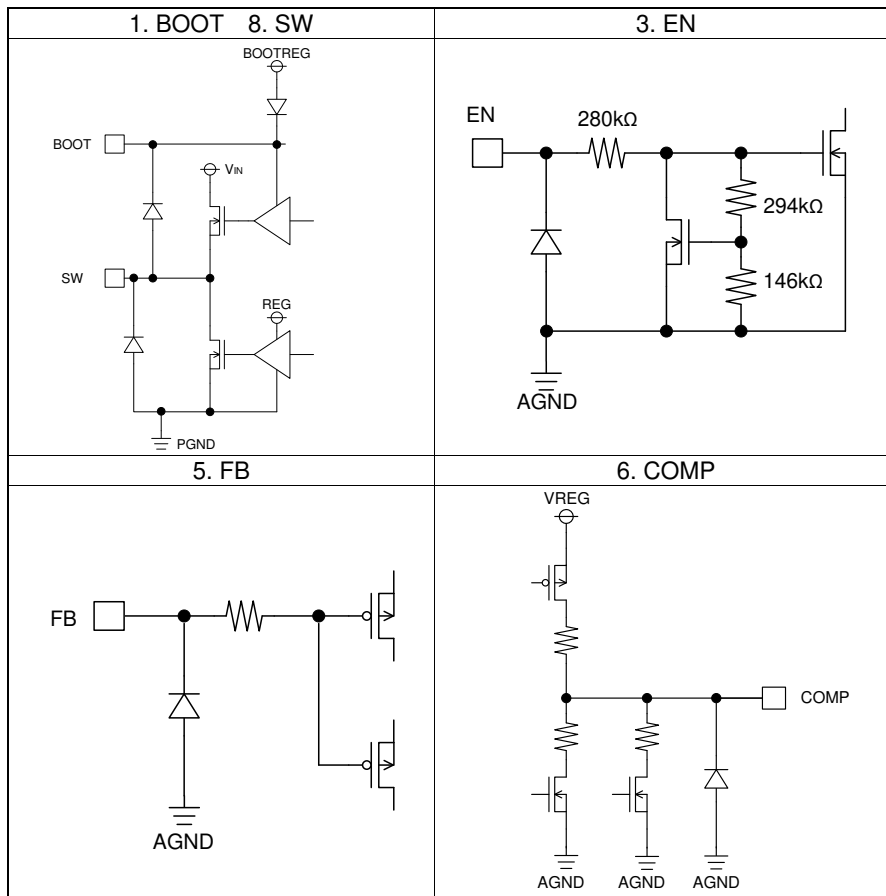

Figure 54. I/O Equivalent Circuit Chart