



Chipsmall Limited consists of a professional team with an average of over 10 year of expertise in the distribution of electronic components. Based in Hongkong, we have already established firm and mutual-benefit business relationships with customers from,Europe,America and south Asia,supplying obsolete and hard-to-find components to meet their specific needs.

With the principle of “Quality Parts,Customers Priority,Honest Operation,and Considerate Service”,our business mainly focus on the distribution of electronic components. Line cards we deal with include Microchip,ALPS,ROHM,Xilinx,Pulse,ON,Everlight and Freescale. Main products comprise IC,Modules,Potentiometer,IC Socket,Relay,Connector.Our parts cover such applications as commercial,industrial, and automotives areas.

We are looking forward to setting up business relationship with you and hope to provide you with the best service and solution. Let us make a better world for our industry!



## Contact us

Tel: +86-755-8981 8866 Fax: +86-755-8427 6832

Email & Skype: info@chipsmall.com Web: www.chipsmall.com

Address: A1208, Overseas Decoration Building, #122 Zhenhua RD., Futian, Shenzhen, China



**NPN Silicon RF Transistor**

- For high gain low noise amplifiers
- For oscillators up to 10 GHz
- Noise figure  $F = 1.1$  dB at 1.8 GHz  
outstanding  $G_{ms} = 21$  dB at 1.8 GHz
- Transition frequency  $f_T = 25$  GHz
- Gold metallization for high reliability
- SIEGET<sup>®</sup> 25 GHz ft - Line
- Pb-free (RoHS compliant) package<sup>1)</sup>
- Qualified according AEC Q101

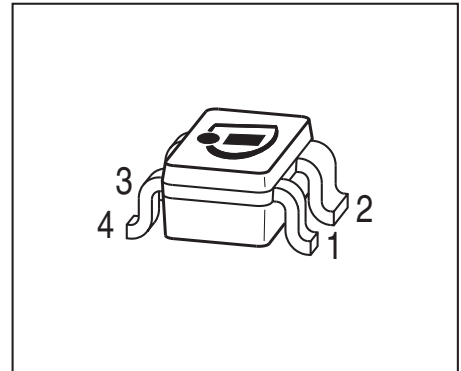

**ESD (Electrostatic discharge) sensitive device, observe handling precaution!**

Type	Marking	Pin Configuration						Package
BFP420	AMs	1=B	2=E	3=C	4=E	-	-	SOT343

**Maximum Ratings**

Parameter	Symbol	Value	Unit
Collector-emitter voltage	$V_{CEO}$		V
$T_A > 0$ °C		4.5	
$T_A \leq 0$ °C		4.1	
Collector-emitter voltage	$V_{CES}$	15	
Collector-base voltage	$V_{CBO}$	15	
Emitter-base voltage	$V_{EBO}$	1.5	
Collector current	$I_C$	35	mA
Base current	$I_B$	3	
Total power dissipation <sup>2)</sup>	$P_{tot}$	160	mW
$T_S \leq 107$ °C			
Junction temperature	$T_j$	150	°C
Ambient temperature	$T_A$	-65 ... 150	
Storage temperature	$T_{stg}$	-65 ... 150	

<sup>1</sup>Pb-containing package may be available upon special request

<sup>2</sup> $T_S$  is measured on the collector lead at the soldering point to the pcb

**Thermal Resistance**

Parameter	Symbol	Value	Unit
Junction - soldering point <sup>1)</sup>	$R_{thJS}$	$\leq 260$	K/W

**Electrical Characteristics at  $T_A = 25^\circ\text{C}$ , unless otherwise specified**

Parameter	Symbol	Values			Unit
		min.	typ.	max.	

**DC Characteristics**

Collector-emitter breakdown voltage $I_C = 1 \text{ mA}, I_B = 0$	$V_{(BR)CEO}$	4.5	5	-	V
Collector-emitter cutoff current $V_{CE} = 15 \text{ V}, V_{BE} = 0$	$I_{CES}$	-	-	10	$\mu\text{A}$
Collector-base cutoff current $V_{CB} = 5 \text{ V}, I_E = 0$	$I_{CBO}$	-	-	100	nA
Emitter-base cutoff current $V_{EB} = 0.5 \text{ V}, I_C = 0$	$I_{EBO}$	-	-	3	$\mu\text{A}$
DC current gain $I_C = 20 \text{ mA}, V_{CE} = 4 \text{ V}, \text{ pulse measured}$	$h_{FE}$	60	95	130	-

<sup>1)</sup>For calculation of  $R_{thJA}$  please refer to Application Note Thermal Resistance

**Electrical Characteristics at  $T_A = 25^\circ\text{C}$ , unless otherwise specified**

Parameter	Symbol	Values			Unit
		min.	typ.	max.	
<b>AC Characteristics (verified by random sampling)</b>					
Transition frequency $I_C = 30\text{ mA}$ , $V_{CE} = 3\text{ V}$ , $f = 2\text{ GHz}$	$f_T$	18	25	-	GHz
Collector-base capacitance $V_{CB} = 2\text{ V}$ , $f = 1\text{ MHz}$ , $V_{BE} = 0$ , emitter grounded	$C_{cb}$	-	0.15	0.3	pF
Collector emitter capacitance $V_{CE} = 2\text{ V}$ , $f = 1\text{ MHz}$ , $V_{BE} = 0$ , base grounded	$C_{ce}$	-	0.37	-	
Emitter-base capacitance $V_{EB} = 0.5\text{ V}$ , $f = 1\text{ MHz}$ , $V_{CB} = 0$ , collector grounded	$C_{eb}$	-	0.55	-	
Noise figure $I_C = 5\text{ mA}$ , $V_{CE} = 2\text{ V}$ , $f = 1.8\text{ GHz}$ , $Z_S = Z_{Sopt}$	$F$	-	1.1	-	dB
Power gain, maximum stable <sup>1)</sup> $I_C = 20\text{ mA}$ , $V_{CE} = 2\text{ V}$ , $Z_S = Z_{Sopt}$ , $Z_L = Z_{Lopt}$ , $f = 1.8\text{ GHz}$	$G_{ms}$	-	21	-	dB
Insertion power gain $V_{CE} = 2\text{ V}$ , $I_C = 20\text{ mA}$ , $f = 1.8\text{ GHz}$ , $Z_S = Z_L = 50\ \Omega$	$ S_{21} ^2$	14	17	-	
Third order intercept point at output <sup>2)</sup> $V_{CE} = 2\text{ V}$ , $I_C = 20\text{ mA}$ , $f = 1.8\text{ GHz}$ , $Z_S = Z_L = 50\ \Omega$	$IP_3$	-	22	-	dBm
1dB Compression point at output $I_C = 20\text{ mA}$ , $V_{CE} = 2\text{ V}$ , $Z_S = Z_L = 50\ \Omega$ , $f = 1.8\text{ GHz}$	$P_{-1dB}$	-	12	-	

$$^1G_{ms} = |S_{21} / S_{12}|$$

<sup>2</sup>IP3 value depends on termination of all intermodulation frequency components.  
Termination used for this measurement is 50Ω from 0.1 MHz to 6 GHz

**Simulation Data**

For SPICE-model as well as for S-parameters including noise parameters refer to our internet website: [www.infineon.com/rf.models](http://www.infineon.com/rf.models). Please consult our website and download the latest version before actually starting your design.

The simulation data have been generated and verified up to 10 GHz using typical devices. The BFP420 nonlinear SPICE-model reflects the typical DC- and RF-device performance with high accuracy.

**Total power dissipation  $P_{tot} = f(T_S)$**

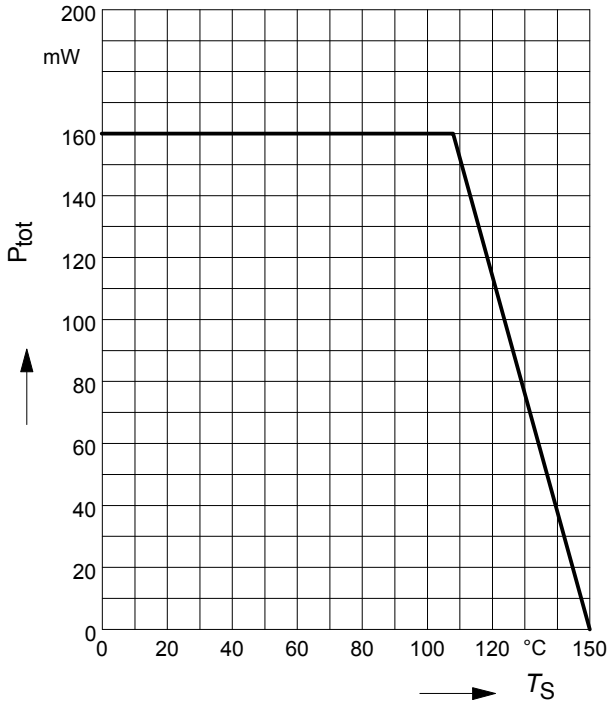

**Permissible Pulse Load  $R_{thJS} = f(t_p)$**

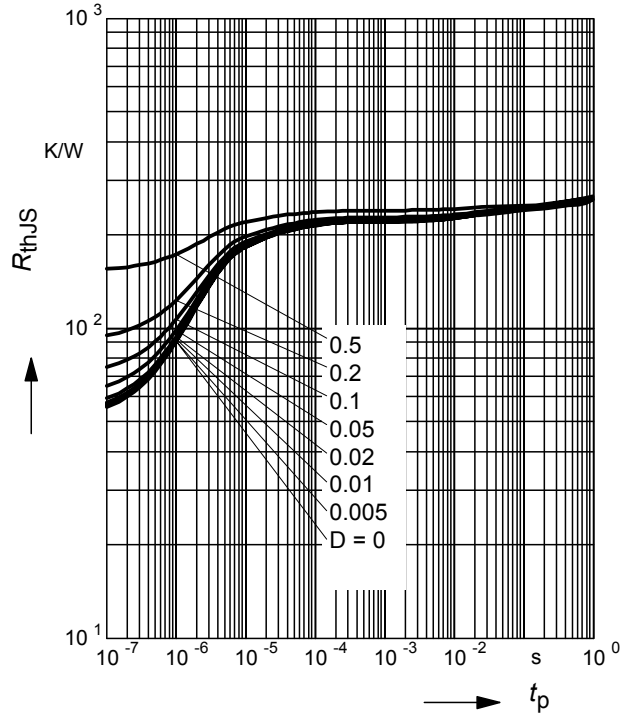

**Permissible Pulse Load**

$P_{totmax}/P_{totDC} = f(t_p)$

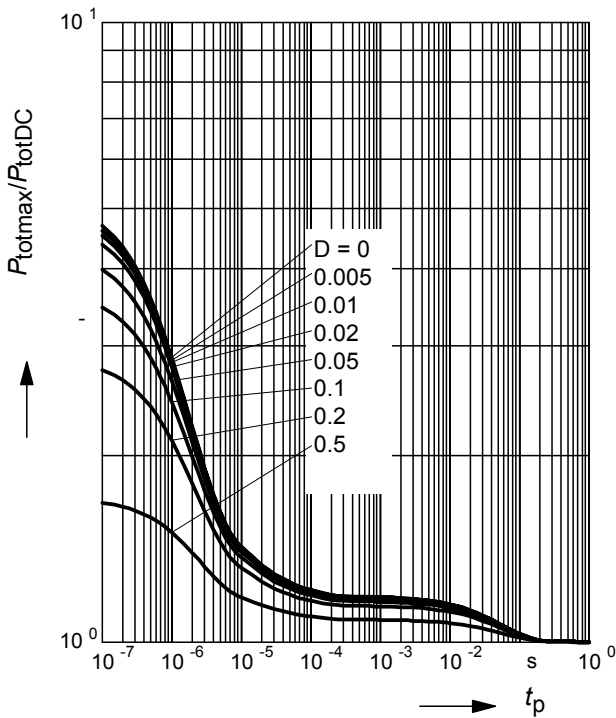

**Collector-base capacitance  $C_{cb} = f(V_{CB})$**

$f = 1\text{MHz}$

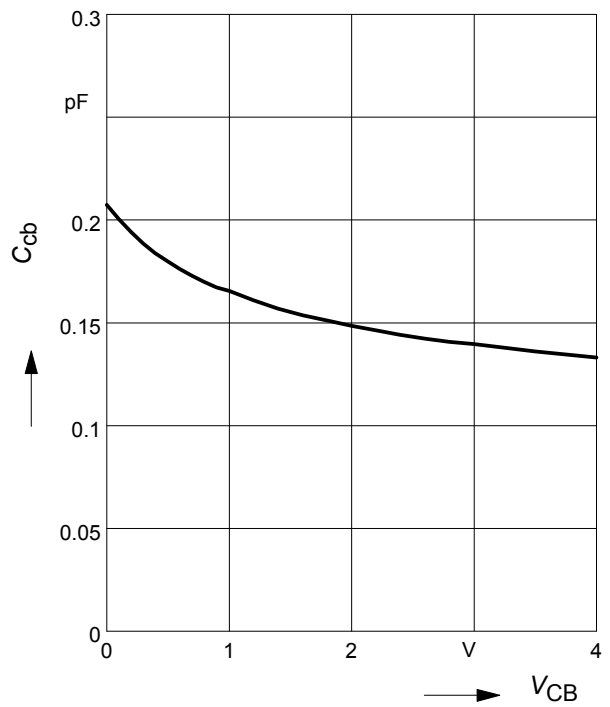

Transition frequency  $f_T = f(I_C)$

$f = 2 \text{ GHz}$

$V_{CE} = \text{parameter in V}$

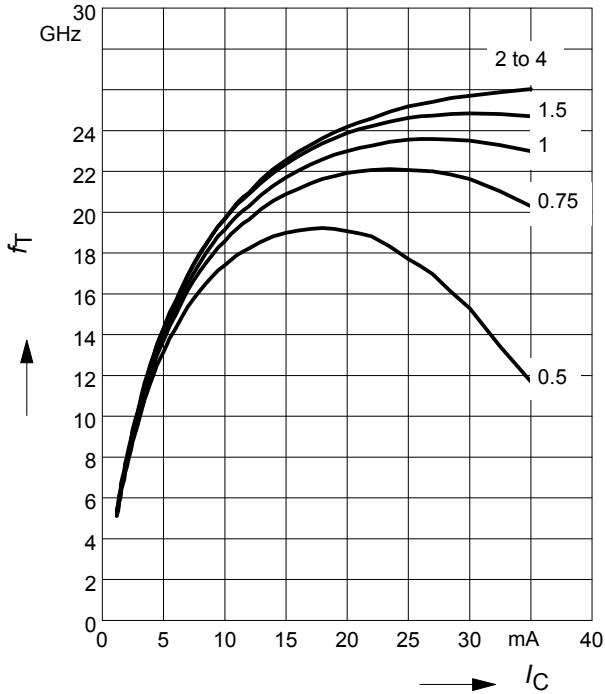

Power gain  $G_{ma}, G_{ms}, |S_{21}|^2 = f(f)$

$V_{CE} = 2 \text{ V}, I_C = 20 \text{ mA}$

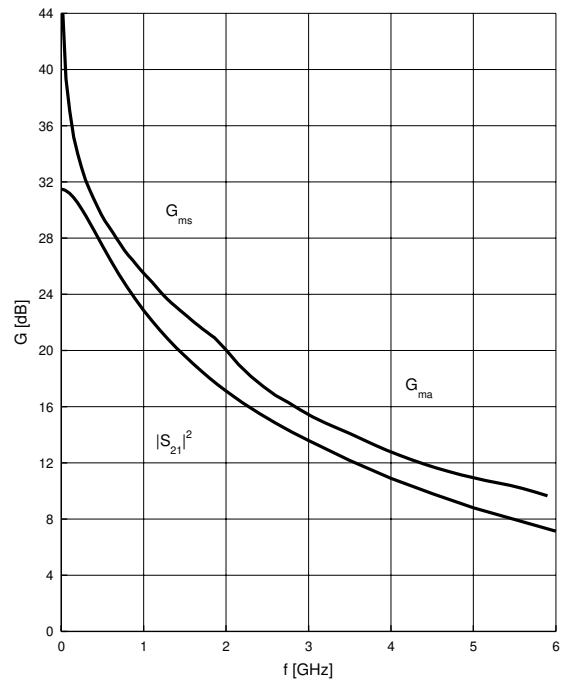

Power gain  $G_{ma}, G_{ms} = f(I_C)$

$V_{CE} = 2 \text{ V}$

$f = \text{parameter in GHz}$

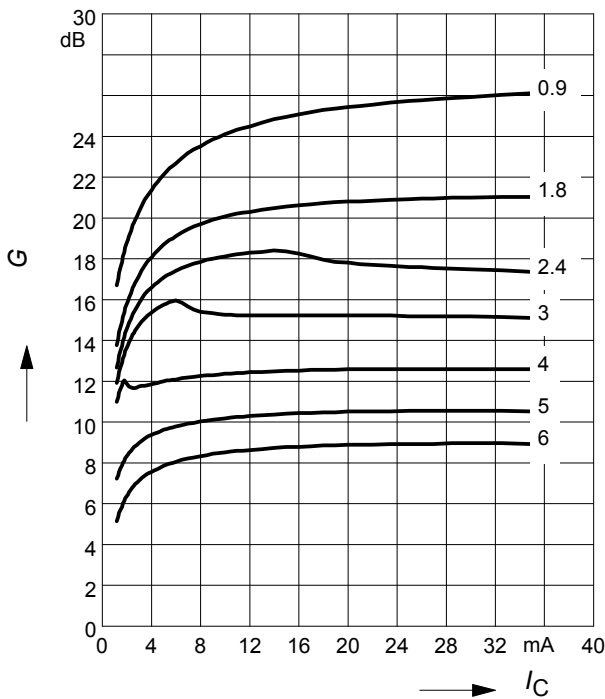

Power gain  $G_{ma}, G_{ms} = f(V_{CE})$

$I_C = 20 \text{ mA}$

$f = \text{parameter in GHz}$

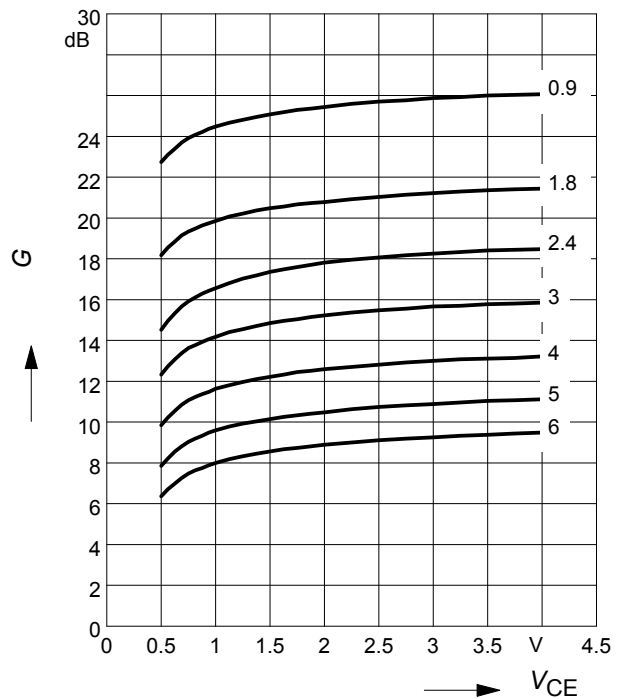

Noise figure  $F = f(I_C)$

$V_{CE} = 2\text{ V}$ ,  $Z_S = Z_{Sopt}$

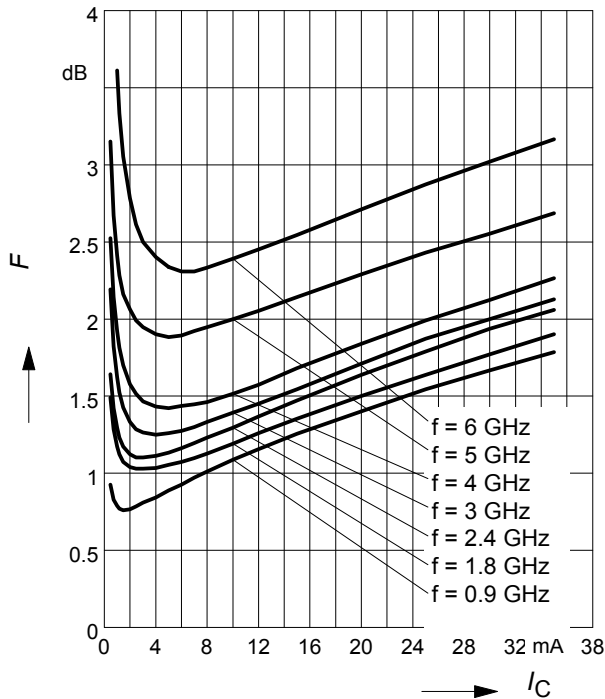

Noise figure  $F = f(I_C)$

$V_{CE} = 2\text{ V}$ ,  $f = 1.8\text{ GHz}$

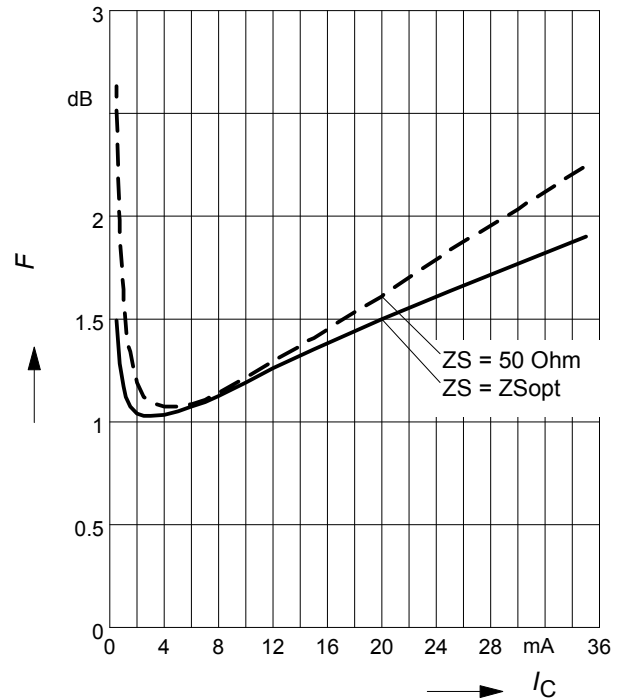

Noise figure  $F = f(f)$

$V_{CE} = 2\text{ V}$ ,  $Z_S = Z_{Sopt}$

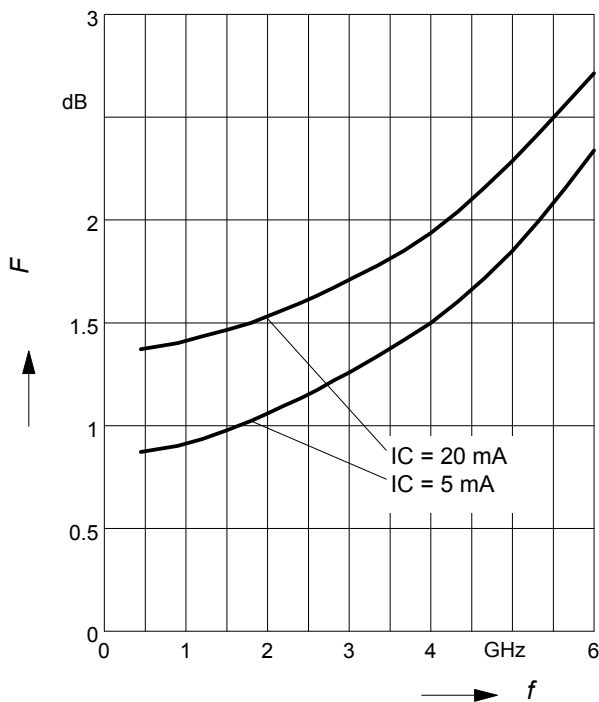

Source impedance for min.

noise figure vs. frequency

$V_{CE} = 2\text{ V}$ ,  $I_C = 5\text{ mA} / 20\text{ mA}$

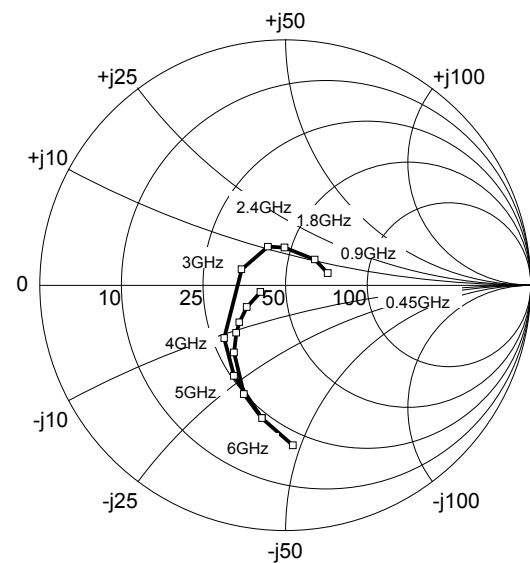



Package Outline

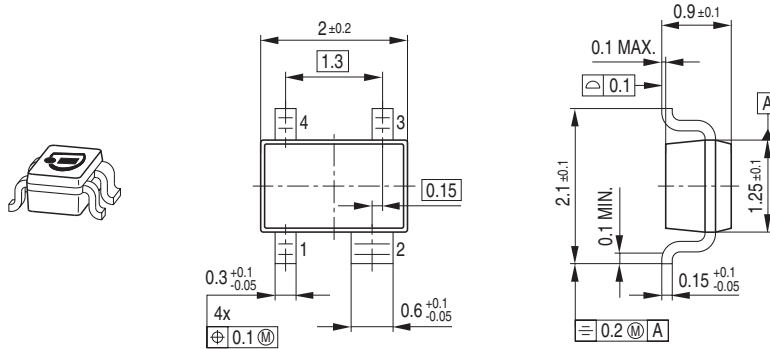

Foot Print

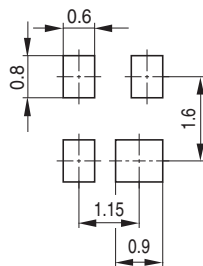

Marking Layout (Example)

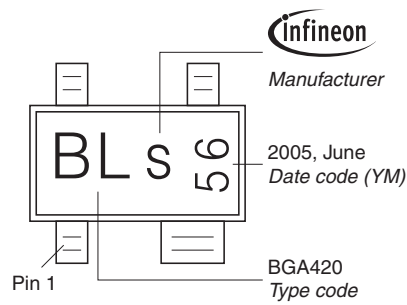

Standard Packing

Reel ø180 mm = 3.000 Pieces/Reel  
 Reel ø330 mm = 10.000 Pieces/Reel

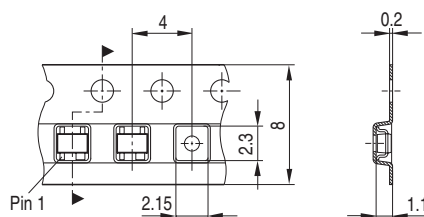

Edition 2009-12-02

Published by

Infineon Technologies AG

85579 Neubiberg, Germany

© Infineon Technologies AG 2009.

All Rights Reserved.

### **Attention please!**

The information herein is given to describe certain components and shall not be considered as a guarantee of characteristics.

Terms of delivery and rights to technical change reserved.

We hereby disclaim any and all warranties, including but not limited to warranties of non-infringement, regarding circuits, descriptions and charts stated herein.

### **Information**

For further information on technology, delivery terms and conditions and prices please contact your nearest Infineon Technologies Office ([www.infineon.com](http://www.infineon.com)).

### **Warnings**

Due to technical requirements components may contain dangerous substances.

For information on the types in question please contact your nearest Infineon Technologies Office.

Infineon Technologies Components may only be used in life-support devices or systems with the express written approval of Infineon Technologies, if a failure of such components can reasonably be expected to cause the failure of that life-support device or system, or to affect the safety or effectiveness of that device or system.

Life support devices or systems are intended to be implanted in the human body, or to support and/or maintain and sustain and/or protect human life. If they fail, it is reasonable to assume that the health of the user or other persons may be endangered.