



Chipsmall Limited consists of a professional team with an average of over 10 year of expertise in the distribution of electronic components. Based in Hongkong, we have already established firm and mutual-benefit business relationships with customers from,Europe,America and south Asia,supplying obsolete and hard-to-find components to meet their specific needs.

With the principle of "Quality Parts,Customers Priority,Honest Operation,and Considerate Service",our business mainly focus on the distribution of electronic components. Line cards we deal with include Microchip,ALPS,ROHM,Xilinx,Pulse,ON,Everlight and Freescale. Main products comprise IC,Modules,Potentiometer,IC Socket,Relay,Connector.Our parts cover such applications as commercial,industrial, and automotives areas.

We are looking forward to setting up business relationship with you and hope to provide you with the best service and solution. Let us make a better world for our industry!



## Contact us

Tel: +86-755-8981 8866 Fax: +86-755-8427 6832

Email & Skype: info@chipsmall.com Web: www.chipsmall.com

Address: A1208, Overseas Decoration Building, #122 Zhenhua RD., Futian, Shenzhen, China



# DATA SHEET

**BFT93W**

PNP 4 GHz wideband transistor

Product specification  
Supersedes data of November 1992

March 1994



# PNP 4 GHz wideband transistor

# BFT93W

### FEATURES

- High power gain
- Gold metallization ensures excellent reliability
- SOT323 (S-mini) package.

### APPLICATIONS

It is intended as a general purpose transistor for wideband applications up to 2 GHz.

### DESCRIPTION

Silicon PNP transistor in a plastic, SOT323 (S-mini) package. The BFT93W uses the same crystal as the SOT23 version, BFT93.

### PINNING

PIN	DESCRIPTION
1	base
2	emitter
3	collector

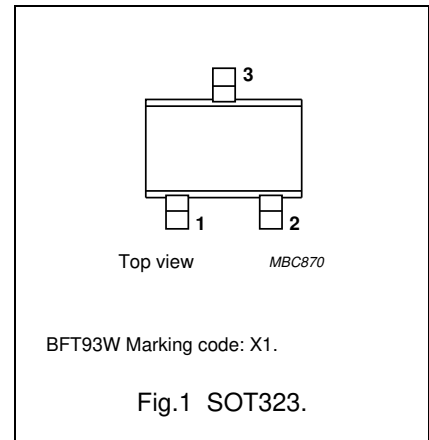

### QUICK REFERENCE DATA

SYMBOL	PARAMETER	CONDITIONS	MIN.	TYP.	MAX.	UNIT
$V_{CBO}$	collector-base voltage	open emitter	–	–	–15	V
$V_{CEO}$	collector-emitter voltage	open base	–	–	–12	V
$I_C$	collector current (DC)		–	–	–50	mA
$P_{tot}$	total power dissipation	up to $T_s = 93\text{ °C}$ ; note 1	–	–	300	mW
$h_{FE}$	DC current gain	$I_C = -30\text{ mA}$ ; $V_{CE} = -5\text{ V}$	20	50	–	
$C_{re}$	feedback capacitance	$I_C = 0$ ; $V_{CE} = -5\text{ V}$ ; $f = 1\text{ MHz}$	–	1	–	pF
$f_T$	transition frequency	$I_C = -30\text{ mA}$ ; $V_{CE} = -5\text{ V}$ ; $f = 500\text{ MHz}$	–	4	–	GHz
$G_{UM}$	maximum unilateral power gain	$I_C = -30\text{ mA}$ ; $V_{CE} = -5\text{ V}$ ; $f = 500\text{ MHz}$ ; $T_{amb} = 25\text{ °C}$	–	15.5	–	dB
F	noise figure	$I_C = -10\text{ mA}$ ; $V_{CE} = -5\text{ V}$ ; $f = 500\text{ MHz}$	–	2.4	–	dB
$T_j$	junction temperature		–	–	150	°C

### Note

1.  $T_s$  is the temperature at the soldering point of the collector pin.

PNP 4 GHz wideband transistor

BFT93W

**LIMITING VALUES**

In accordance with the Absolute Maximum Rating System (IEC 134).

SYMBOL	PARAMETER	CONDITIONS	MIN.	MAX.	UNIT
V <sub>CB0</sub>	collector-base voltage	open emitter	–	–15	V
V <sub>CEO</sub>	collector-emitter voltage	open base	–	–12	V
V <sub>EBO</sub>	emitter-base voltage	open collector	–	–2	V
I <sub>C</sub>	collector current (DC)		–	–50	mA
P <sub>tot</sub>	total power dissipation	up to T <sub>s</sub> = 93 °C; note 1	–	300	mW
T <sub>stg</sub>	storage temperature		–65	+150	°C
T <sub>j</sub>	junction temperature		–	150	°C

**THERMAL CHARACTERISTICS**

SYMBOL	PARAMETER	CONDITIONS	VALUE	UNIT
R <sub>th j-s</sub>	thermal resistance from junction to soldering point	up to T <sub>s</sub> = 93 °C; note 1	190	K/W

**Note to the “Limiting values” and “Thermal characteristics”**

1. T<sub>s</sub> is the temperature at the soldering point of the collector pin.

**CHARACTERISTICS**

T<sub>j</sub> = 25 °C (unless otherwise specified).

SYMBOL	PARAMETER	CONDITIONS	MIN.	TYP.	MAX.	UNIT
I <sub>CBO</sub>	collector cut-off current	I <sub>E</sub> = 0; V <sub>CB</sub> = –5 V	–	–	–50	nA
h <sub>FE</sub>	DC current gain	I <sub>C</sub> = –30 mA; V <sub>CE</sub> = –5 V	20	50	–	
f <sub>T</sub>	transition frequency	I <sub>C</sub> = –30 mA; V <sub>CE</sub> = –5 V; f = 500 MHz; T <sub>amb</sub> = 25 °C	–	4	–	GHz
C <sub>c</sub>	collector capacitance	I <sub>E</sub> = i <sub>e</sub> = 0; V <sub>CB</sub> = –5 V; f = 1 MHz	–	1.2	–	pF
C <sub>e</sub>	emitter capacitance	I <sub>C</sub> = i <sub>c</sub> = 0; V <sub>EB</sub> = –0.5 V; f = 1 MHz	–	1.4	–	pF
C <sub>re</sub>	feedback capacitance	I <sub>C</sub> = 0; V <sub>CE</sub> = –5 V; f = 1 MHz	–	1	–	pF
G <sub>UM</sub>	maximum unilateral power gain; note 1	I <sub>C</sub> = –30 mA; V <sub>CE</sub> = –5 V; f = 500 MHz; T <sub>amb</sub> = 25 °C	–	15.5	–	dB
		I <sub>C</sub> = –30 mA; V <sub>CE</sub> = –5 V; f = 1 GHz; T <sub>amb</sub> = 25 °C	–	10	–	dB
F	noise figure	Γ <sub>s</sub> = Γ <sub>opt</sub> ; I <sub>C</sub> = –10 mA; V <sub>CE</sub> = –5 V; f = 500 MHz	–	2.4	–	dB
		Γ <sub>s</sub> = Γ <sub>opt</sub> ; I <sub>C</sub> = –10 mA; V <sub>CE</sub> = –5 V; f = 1 GHz	–	3	–	dB

**Note**

1. G<sub>UM</sub> is the maximum unilateral power gain, assuming s<sub>12</sub> is zero.  $G_{UM} = 10 \log \frac{|s_{21}|^2}{(1 - |s_{11}|^2)(1 - |s_{22}|^2)}$  dB.

PNP 4 GHz wideband transistor

BFT93W

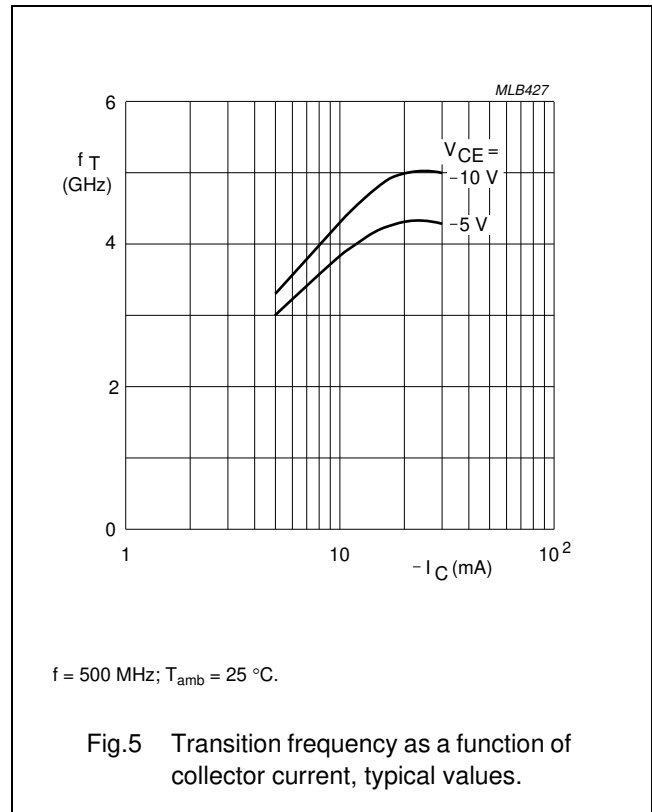
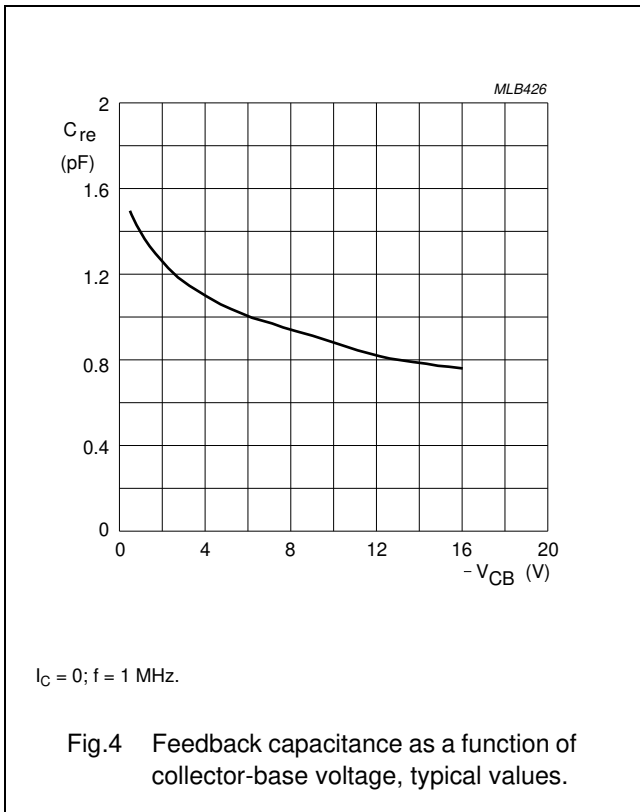
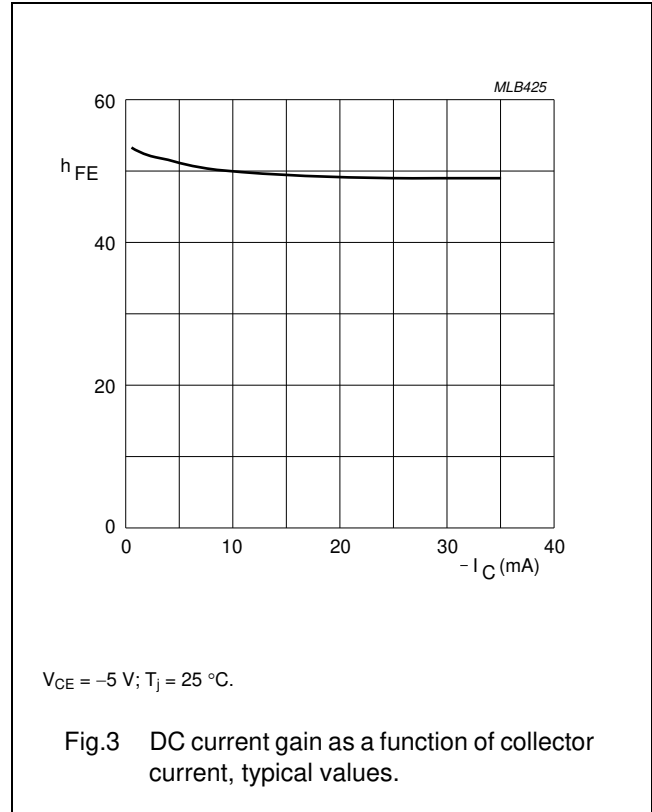
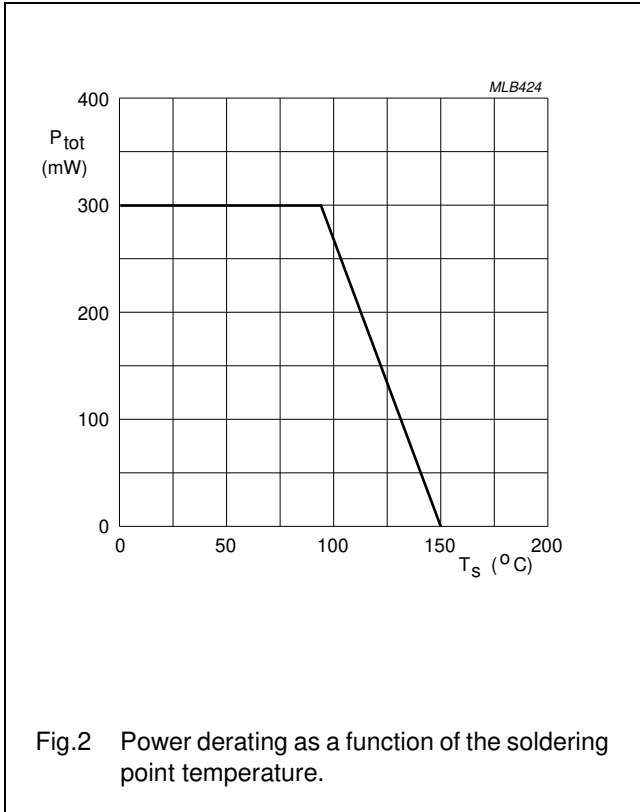

PNP 4 GHz wideband transistor

BFT93W

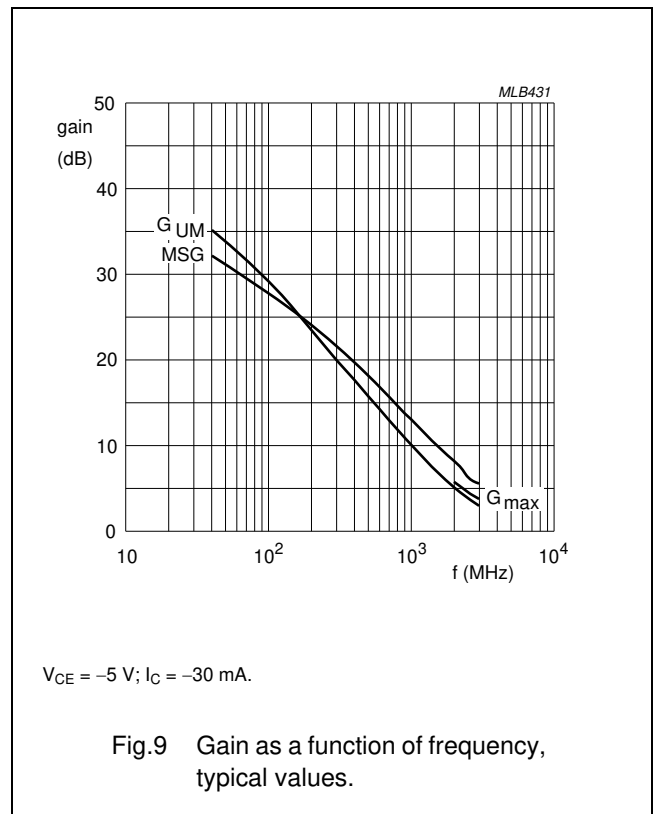
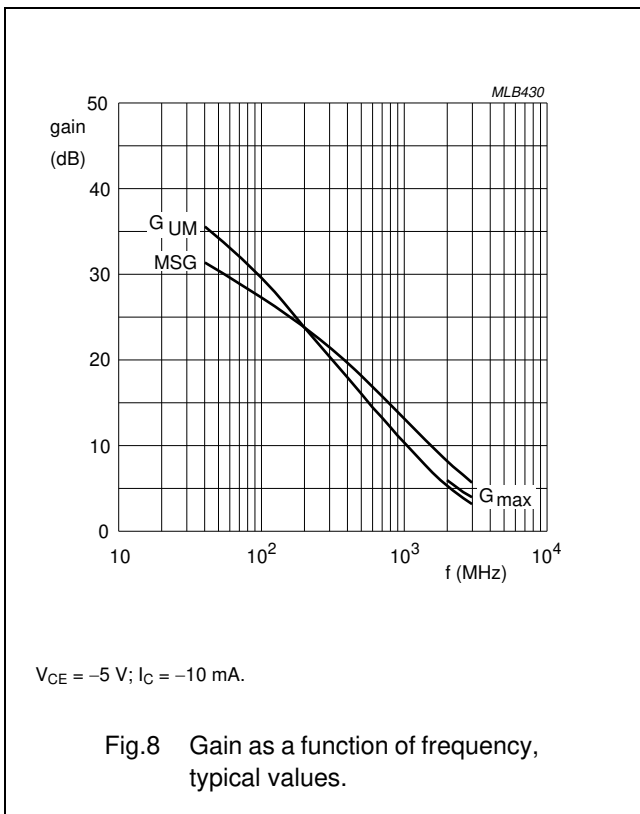
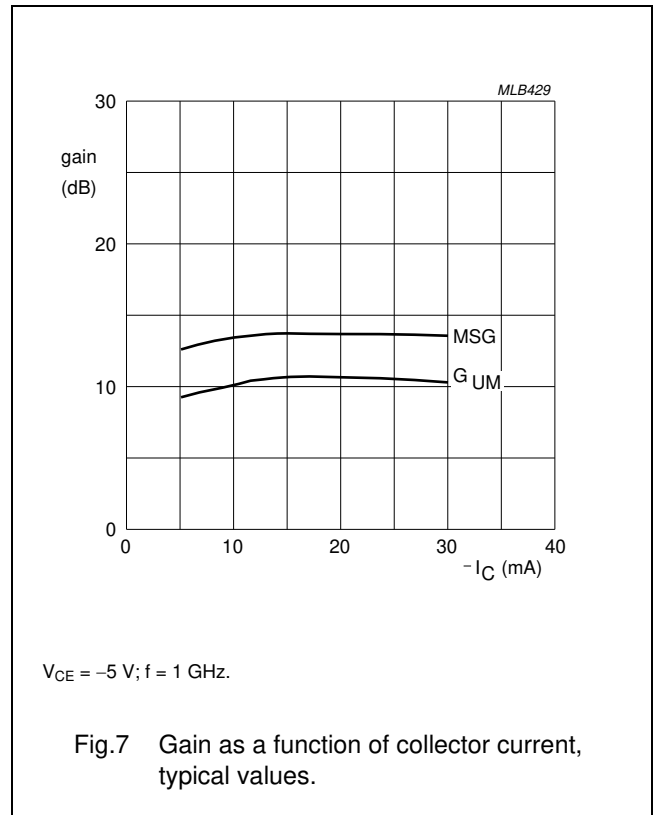
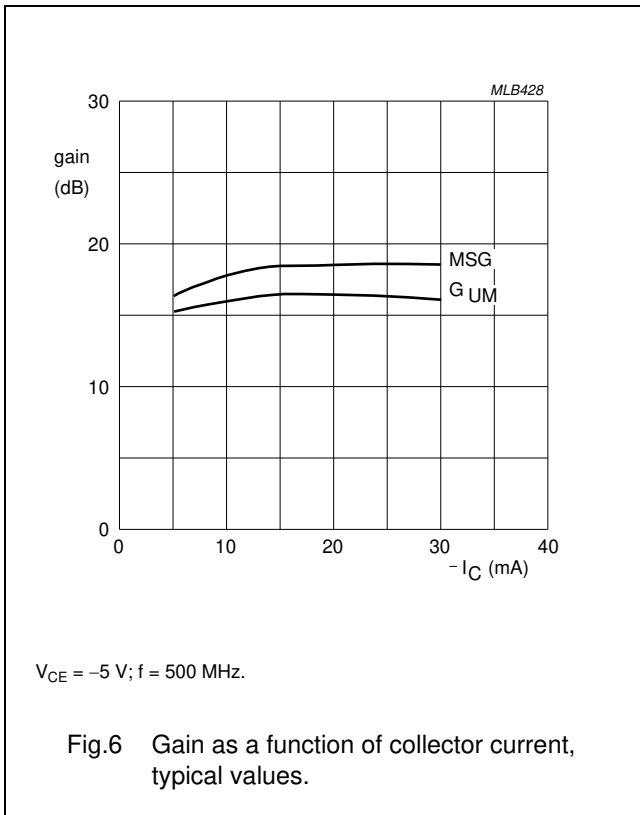

PNP 4 GHz wideband transistor

BFT93W

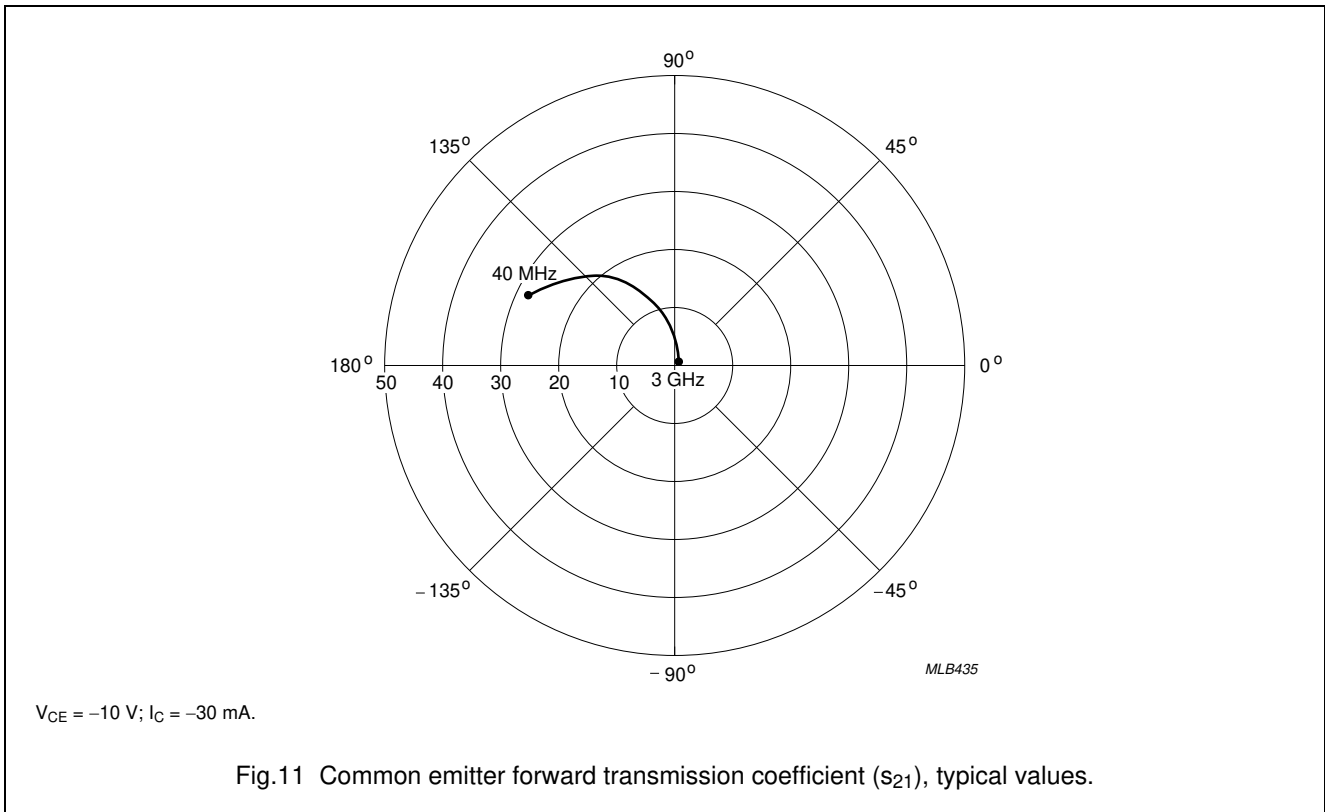
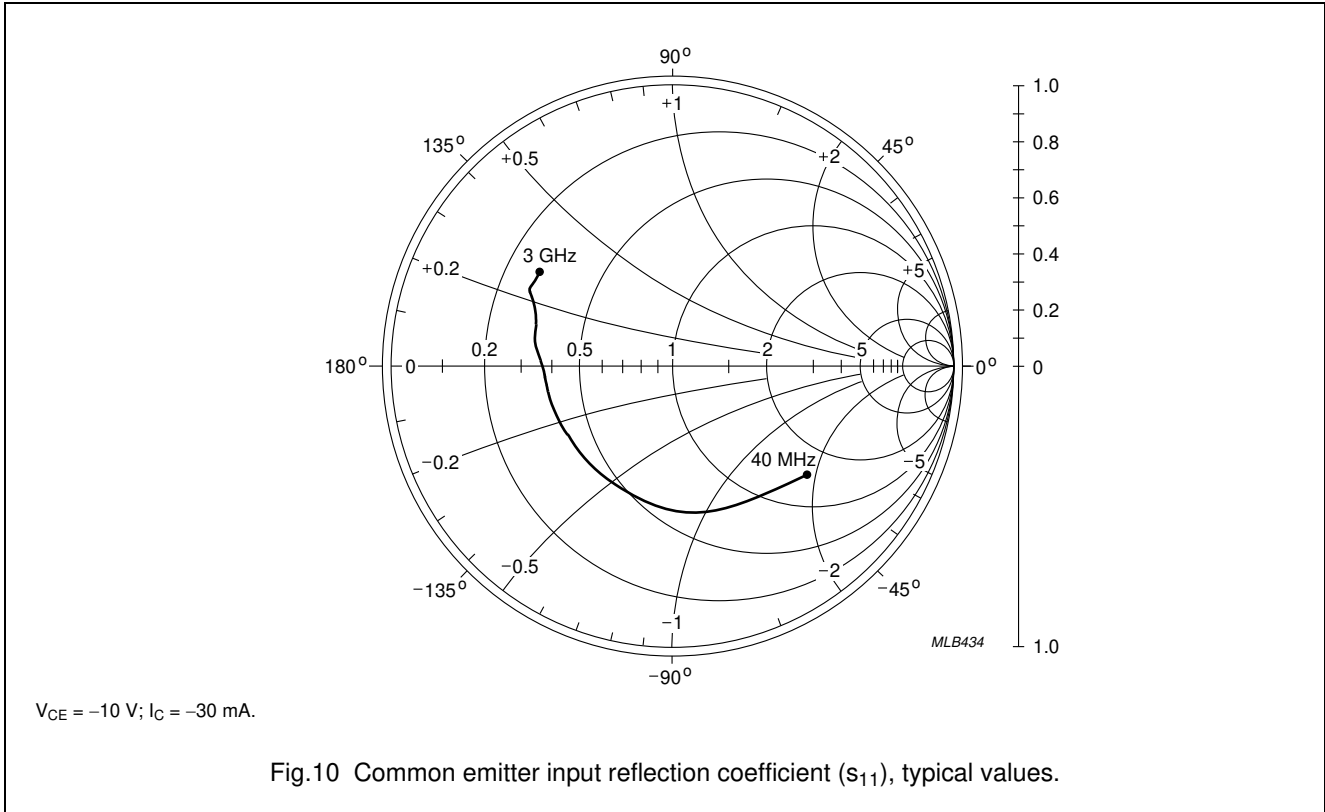

PNP 4 GHz wideband transistor

BFT93W

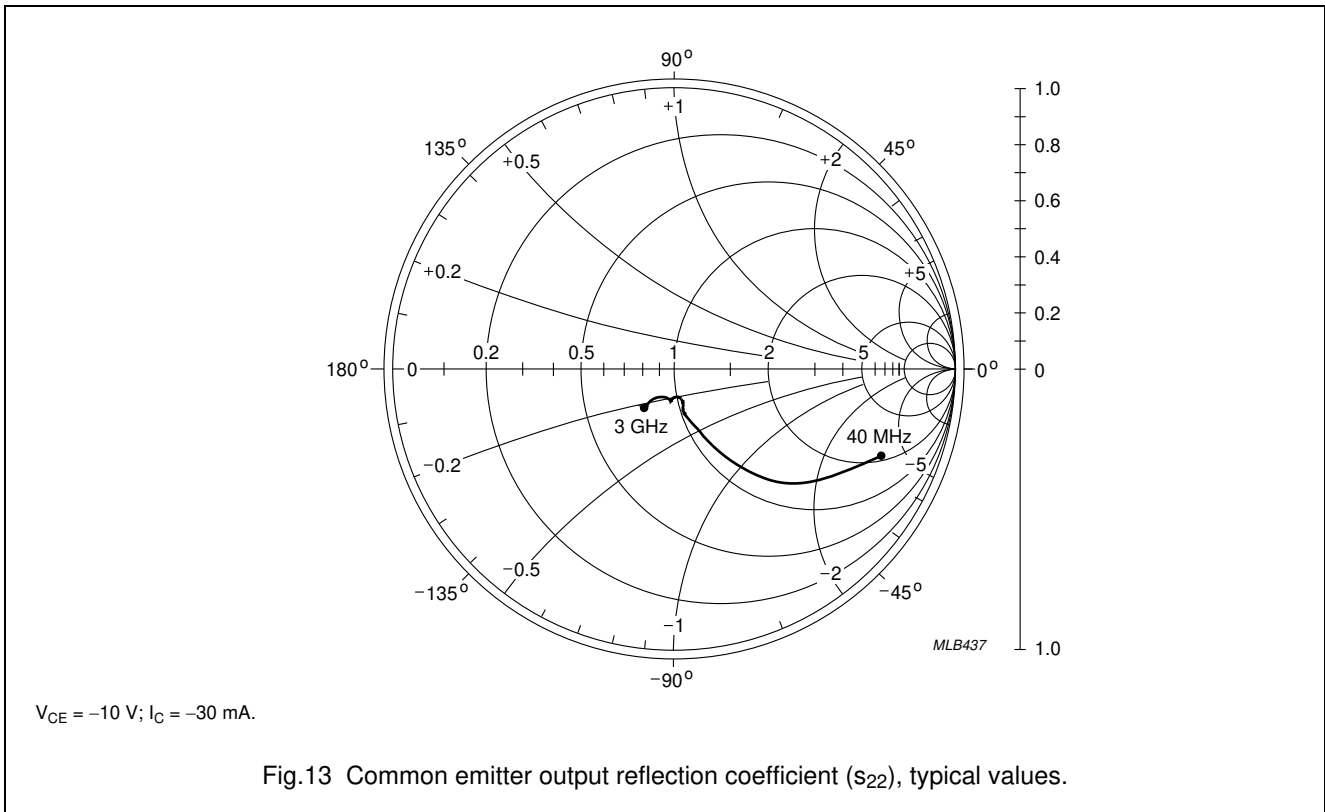
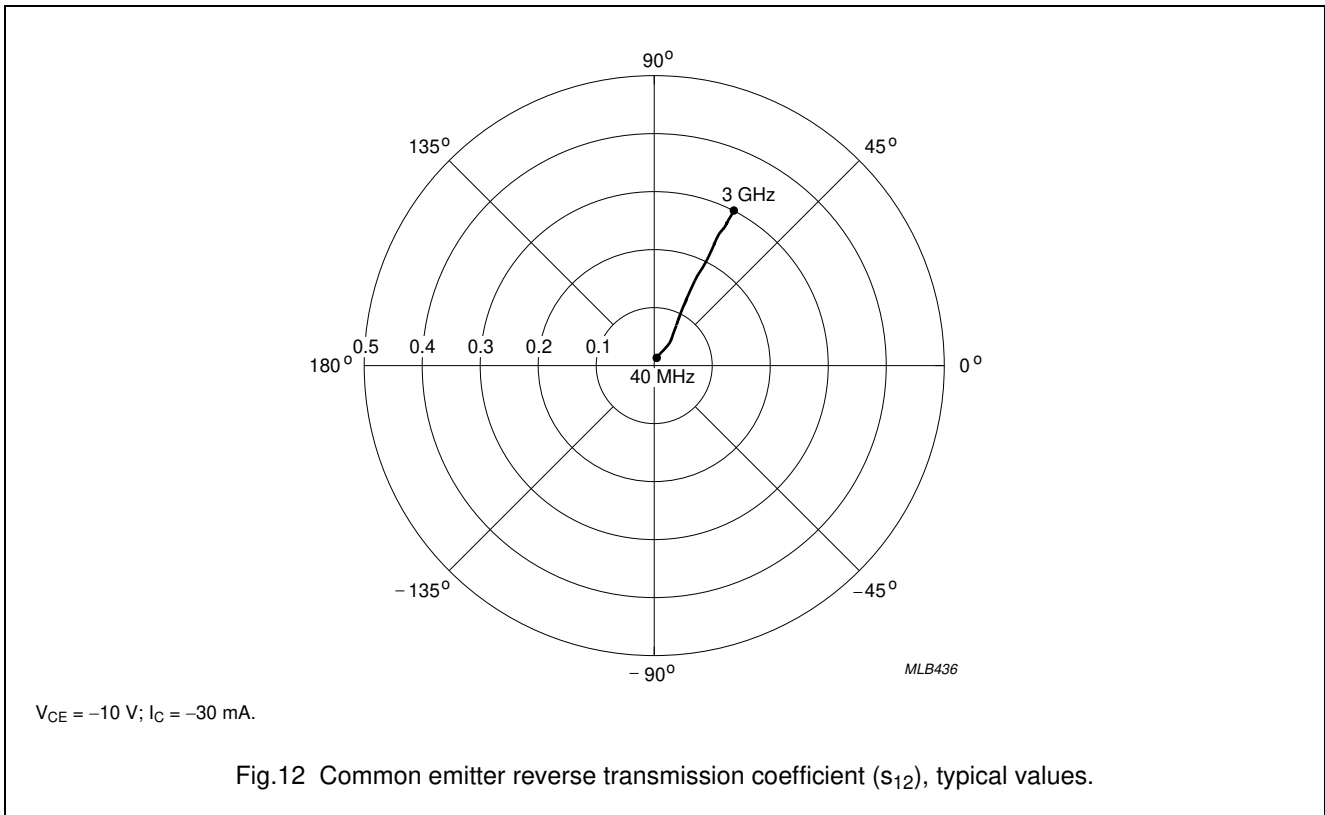



PNP 4 GHz wideband transistor

BFT93W

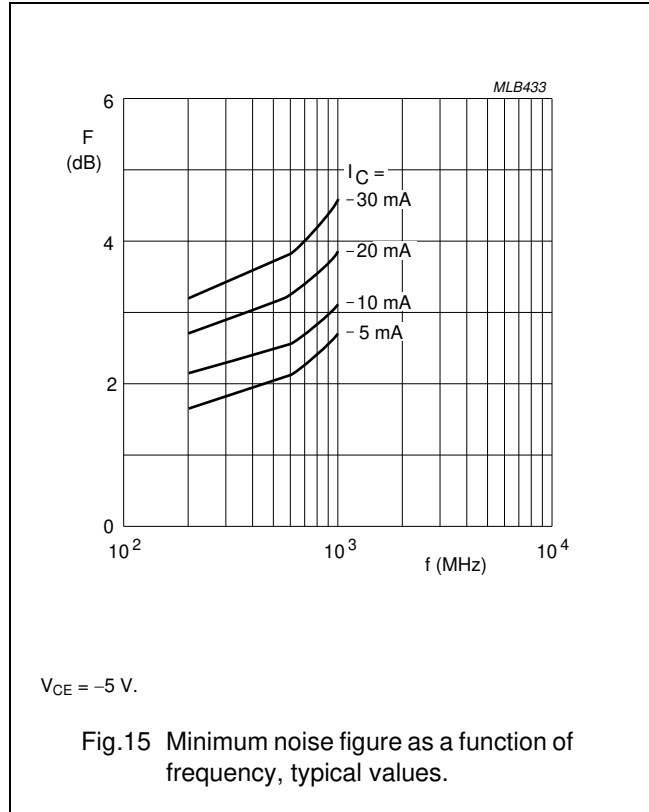
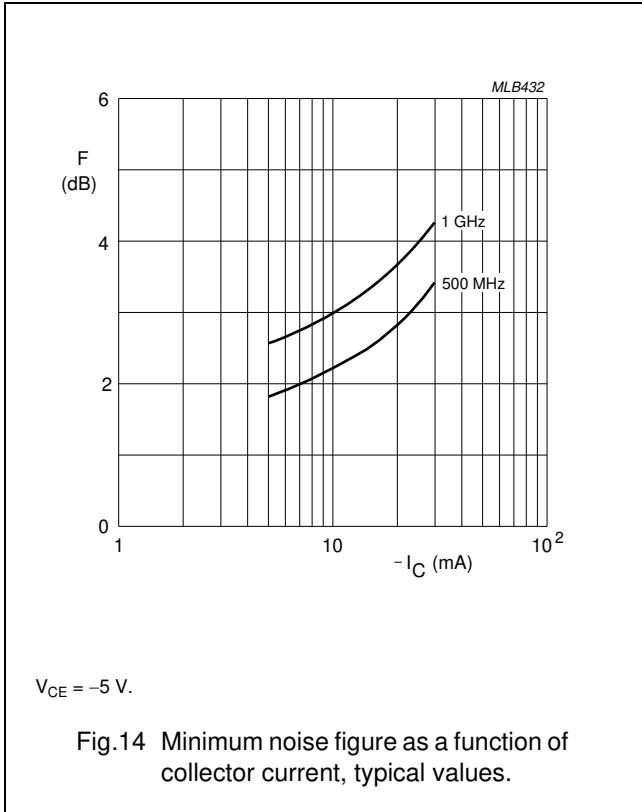

PNP 4 GHz wideband transistor

BFT93W

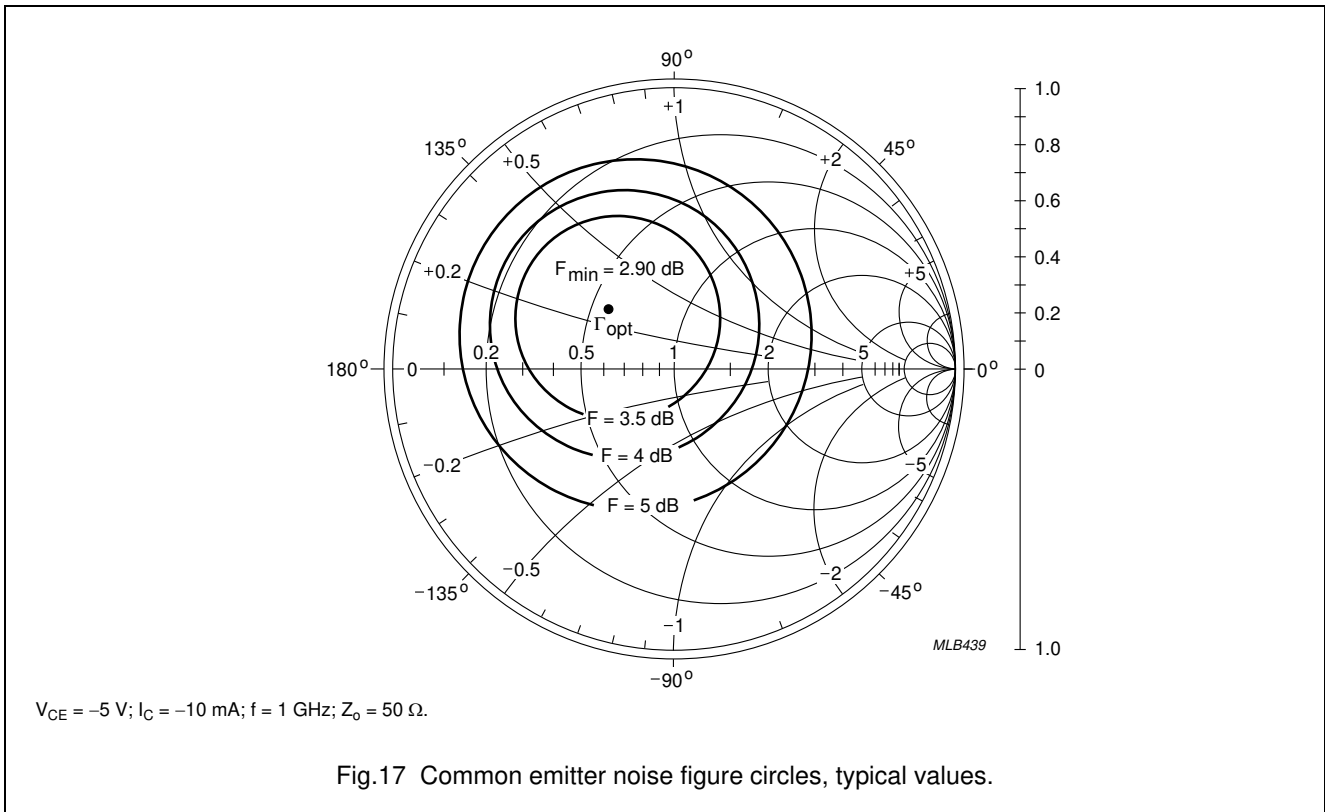
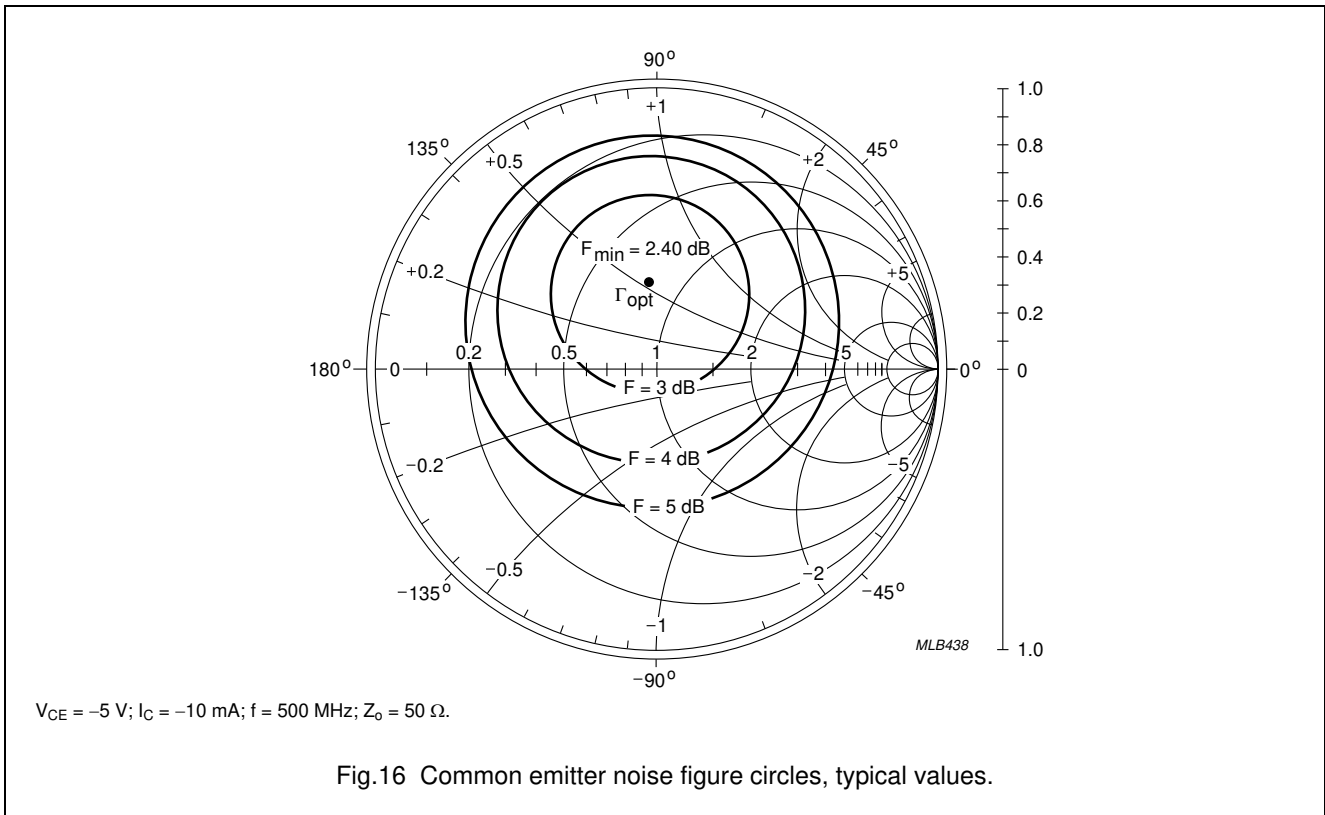

PNP 4 GHz wideband transistor

BFT93W

SPICE parameters for the BFT93W crystal

SEQUENCE No.	PARAMETER	VALUE	UNIT
1	IS	835.1	aA
2	BF	48.56	–
3	NF	1.000	–
4	VAF	19.01	V
5	IKF	146.8	mA
6	ISE	90.94	fA
7	NE	1.749	–
8	BR	12.18	–
9	NR	997.6	m
10	VAR	3.374	V
11	IKR	6.742	mA
12	ISC	23.42	fA
13	NC	1.449	–
14	RB	10.00	$\Omega$
15	IRB	1.000	$\mu$ A
16	RBM	10.00	$\Omega$
17	RE	200.0	m $\Omega$
18	RC	3.800	$\Omega$
19 <sup>(1)</sup>	XTB	0.000	–
20 <sup>(1)</sup>	EG	1.110	EV
21 <sup>(1)</sup>	XTI	3.000	–
22	CJE	1.570	pF
23	VJE	600.0	mV
24	MJE	382.2	m
25	TF	14.85	ps
26	XTF	2.209	–
27	VTF	2.989	V
28	ITF	14.37	mA
29	PTF	0.000	deg
30	CJC	1.995	pF
31	VJC	584.4	mV
32	MJC	281.3	m
33	XCJC	120.0	m
34	TR	3.000	ns
35 <sup>(1)</sup>	CJS	0.000	F

SEQUENCE No.	PARAMETER	VALUE	UNIT
36 <sup>(1)</sup>	VJS	750.0	mV
37 <sup>(1)</sup>	MJS	0.000	–
38	FC	811.6	m

Note

1. These parameters have not been extracted, the default values are shown.

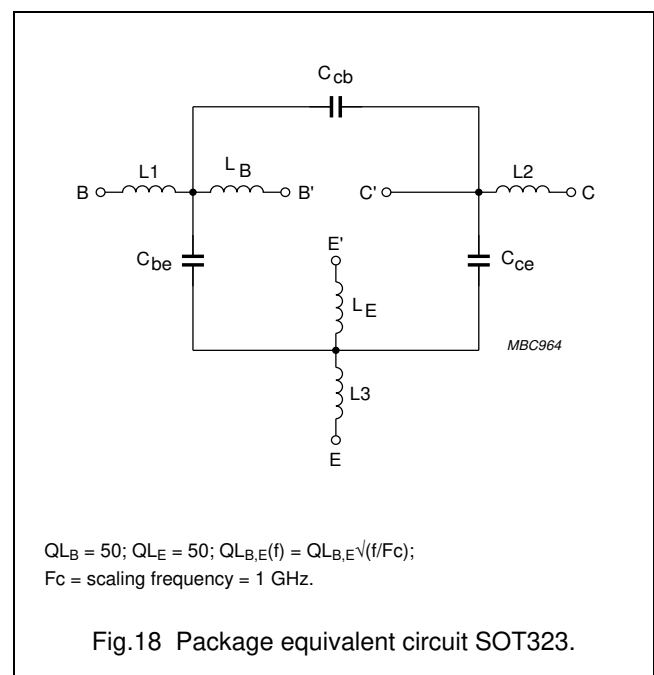

List of components (see Fig.18).

DESIGNATION	VALUE	UNIT
$C_{be}$	2	fF
$C_{cb}$	100	fF
$C_{ce}$	100	fF
L1	0.34	nH
L2	0.10	nH
L3	0.34	nH
$L_B$	0.60	nH
$L_E$	0.60	nH

PNP 4 GHz wideband transistor

BFT93W

**Table 1** Common emitter scattering parameters:  $V_{CE} = -5\text{ V}$ ;  $I_C = -5\text{ mA}$ .

f (MHz)	S <sub>11</sub>		S <sub>21</sub>		S <sub>12</sub>		S <sub>22</sub>		G <sub>UM</sub> (dB)
	MAGNITUDE (ratio)	ANGLE (deg)	MAGNITUDE (ratio)	ANGLE (deg)	MAGNITUDE (ratio)	ANGLE (deg)	MAGNITUDE (ratio)	ANGLE (deg)	
40	0.759	-20.5	11.294	165.0	0.023	78.5	0.945	-12.3	34.5
100	0.711	-49.0	10.079	147.7	0.050	64.5	0.834	-27.8	28.3
200	0.630	-88.0	8.082	126.7	0.076	51.2	0.631	-44.0	22.5
300	0.586	-113.6	6.355	113.1	0.090	45.1	0.491	-52.8	19.1
400	0.566	-130.5	5.116	104.1	0.099	42.9	0.403	-58.5	16.6
500	0.557	-141.8	4.266	97.5	0.107	42.8	0.349	-62.5	14.8
600	0.551	-150.5	3.653	92.2	0.113	43.7	0.316	-65.2	13.3
700	0.546	-157.1	3.193	87.7	0.120	44.9	0.293	-66.8	12.0
800	0.543	-162.7	2.838	83.9	0.127	46.2	0.277	-67.7	10.9
900	0.541	-167.6	2.551	80.4	0.133	47.6	0.263	-68.1	9.9
1000	0.541	-172.0	2.323	77.4	0.140	49.1	0.249	-68.7	9.1
1200	0.549	-179.4	1.975	71.7	0.153	51.6	0.223	-71.8	7.7
1400	0.559	174.8	1.737	66.4	0.168	53.8	0.212	-78.3	6.6
1600	0.565	170.3	1.555	61.7	0.183	55.2	0.215	-84.5	5.7
1800	0.566	165.6	1.420	57.7	0.197	56.8	0.220	-87.5	4.9
2000	0.575	160.5	1.310	54.2	0.213	58.3	0.215	-91.0	4.3
2200	0.594	156.3	1.217	51.1	0.228	59.7	0.208	-98.1	3.8
2400	0.613	153.7	1.135	47.7	0.242	60.6	0.217	-107.7	3.4
2600	0.623	151.4	1.064	44.8	0.255	60.9	0.242	-114.1	2.9
2800	0.618	148.2	1.019	41.7	0.271	61.5	0.264	-116.9	2.6
3000	0.621	144.5	0.975	39.3	0.289	61.9	0.275	-119.3	2.2

**Table 2** Noise data:  $V_{CE} = -5\text{ V}$ ;  $I_C = -5\text{ mA}$ .

f (MHz)	F <sub>min</sub> (dB)	Γ <sub>opt</sub>		R <sub>n</sub>
		(ratio)	(deg)	
500	1.80	0.307	86.5	0.320
1000	2.55	0.358	121.0	0.280

## PNP 4 GHz wideband transistor

## BFT93W

**Table 3** Common emitter scattering parameters:  $V_{CE} = -5$  V;  $I_C = -10$  mA.

f (MHz)	S <sub>11</sub>		S <sub>21</sub>		S <sub>12</sub>		S <sub>22</sub>		G <sub>UM</sub> (dB)
	MAGNITUDE (ratio)	ANGLE (deg)	MAGNITUDE (ratio)	ANGLE (deg)	MAGNITUDE (ratio)	ANGLE (deg)	MAGNITUDE (ratio)	ANGLE (deg)	
40	0.608	-31.5	18.195	160.2	0.020	75.6	0.900	-18.0	34.4
100	0.571	-72.1	15.044	138.8	0.041	60.6	0.725	-38.4	28.5
200	0.538	-114.5	10.475	117.4	0.059	51.1	0.490	-56.6	23.1
300	0.531	-136.1	7.676	106.0	0.070	49.3	0.360	-66.3	19.7
400	0.531	-149.0	5.989	98.6	0.079	50.2	0.287	-73.0	17.4
500	0.532	-157.3	4.907	93.2	0.088	51.8	0.245	-77.9	15.5
600	0.534	-163.6	4.161	88.9	0.097	53.8	0.221	-81.4	14.1
700	0.533	-168.6	3.613	85.1	0.106	55.4	0.204	-83.2	12.8
800	0.532	-172.9	3.195	81.8	0.116	56.9	0.192	-84.2	11.7
900	0.534	-176.8	2.866	78.8	0.125	58.1	0.179	-84.5	10.7
1000	0.535	179.7	2.603	76.2	0.135	59.3	0.167	-85.3	9.9
1200	0.545	173.7	2.206	71.2	0.153	61.0	0.145	-90.1	8.5
1400	0.557	169.2	1.931	66.6	0.172	62.0	0.140	-98.7	7.4
1600	0.561	165.5	1.724	62.2	0.191	62.3	0.149	-104.6	6.5
1800	0.563	161.2	1.570	58.5	0.208	62.7	0.154	-106.3	5.7
2000	0.574	156.6	1.447	55.2	0.227	63.2	0.150	-109.4	5.0
2200	0.593	153.0	1.343	52.4	0.244	63.7	0.148	-117.9	4.5
2400	0.612	150.6	1.251	49.2	0.260	64.0	0.165	-127.5	4.1
2600	0.620	148.8	1.171	46.3	0.274	63.5	0.192	-131.8	3.6
2800	0.616	146.0	1.122	43.2	0.290	63.3	0.213	-132.1	3.3
3000	0.618	142.3	1.074	40.7	0.309	63.2	0.223	-133.3	2.9

**Table 4** Noise data:  $V_{CE} = -5$  V;  $I_C = -10$  mA.

f (MHz)	F <sub>min</sub> (dB)	Γ <sub>opt</sub>		R <sub>n</sub>
		(ratio)	(deg)	
500	2.40	0.304	94.7	0.430
1000	2.90	0.321	136.9	0.270

## PNP 4 GHz wideband transistor

## BFT93W

**Table 5** Common emitter scattering parameters:  $V_{CE} = -5$  V;  $I_C = -20$  mA.

f (MHz)	S <sub>11</sub>		S <sub>21</sub>		S <sub>12</sub>		S <sub>22</sub>		G <sub>UM</sub> (dB)
	MAGNITUDE (ratio)	ANGLE (deg)	MAGNITUDE (ratio)	ANGLE (deg)	MAGNITUDE (ratio)	ANGLE (deg)	MAGNITUDE (ratio)	ANGLE (deg)	
40	0.450	-49.1	25.274	154.6	0.018	72.5	0.830	-24.1	34.1
100	0.475	-99.1	18.682	130.2	0.034	59.2	0.608	-47.9	28.5
200	0.502	-135.9	11.661	110.7	0.047	54.5	0.379	-67.2	23.3
300	0.516	-151.8	8.244	101.0	0.058	55.6	0.270	-77.9	20.0
400	0.526	-161.1	6.342	94.7	0.068	58.1	0.215	-86.1	17.7
500	0.530	-167.1	5.156	90.2	0.079	60.1	0.185	-92.5	15.8
600	0.534	-171.9	4.350	86.3	0.089	61.9	0.169	-96.7	14.4
700	0.535	-175.7	3.768	83.0	0.101	63.2	0.157	-98.7	13.1
800	0.536	-179.1	3.326	80.1	0.112	64.0	0.147	-99.8	12.0
900	0.538	177.7	2.980	77.3	0.123	64.8	0.137	-100.5	11.1
1000	0.541	174.9	2.703	74.9	0.134	65.4	0.127	-101.9	10.2
1200	0.554	169.8	2.285	70.3	0.154	66.2	0.111	-109.1	8.8
1400	0.566	166.1	1.995	65.9	0.175	66.6	0.112	-118.8	7.7
1600	0.571	162.6	1.777	61.7	0.195	66.0	0.125	-122.9	6.8
1800	0.573	158.8	1.616	58.2	0.214	66.0	0.130	-123.1	6.0
2000	0.585	154.4	1.488	55.0	0.234	66.1	0.127	-126.2	5.3
2200	0.604	151.0	1.380	52.4	0.252	66.2	0.130	-135.1	4.8
2400	0.624	148.8	1.285	49.4	0.268	66.2	0.152	-143.0	4.4
2600	0.633	147.1	1.200	46.6	0.282	65.5	0.180	-144.7	3.9
2800	0.626	144.3	1.148	43.5	0.299	65.0	0.199	-143.3	3.5
3000	0.629	140.8	1.100	41.0	0.319	64.7	0.208	-143.7	3.2

**Table 6** Noise data:  $V_{CE} = -5$  V;  $I_C = -20$  mA.

f (MHz)	F <sub>min</sub> (dB)	Γ <sub>opt</sub>		R <sub>n</sub>
		(ratio)	(deg)	
500	2.80	0.301	100.8	0.610
1000	3.60	0.356	152.2	0.280

PNP 4 GHz wideband transistor

BFT93W

**Table 7** Common emitter scattering parameters:  $V_{CE} = -5\text{ V}$ ;  $I_C = -30\text{ mA}$ .

f (MHz)	S <sub>11</sub>		S <sub>21</sub>		S <sub>12</sub>		S <sub>22</sub>		G <sub>UM</sub> (dB)
	MAGNITUDE (ratio)	ANGLE (deg)	MAGNITUDE (ratio)	ANGLE (deg)	MAGNITUDE (ratio)	ANGLE (deg)	MAGNITUDE (ratio)	ANGLE (deg)	
40	0.382	-62.3	28.063	151.4	0.016	71.2	0.781	-27.1	33.7
100	0.453	-113.1	19.479	126.1	0.030	58.8	0.543	-51.8	28.3
200	0.502	-144.8	11.682	107.7	0.043	56.8	0.327	-70.7	23.1
300	0.521	-158.0	8.162	98.8	0.054	58.9	0.232	-81.5	19.8
400	0.532	-165.8	6.248	92.9	0.065	61.4	0.185	-89.9	17.5
500	0.537	-170.8	5.069	88.6	0.076	63.4	0.161	-96.5	15.7
600	0.542	-174.9	4.269	84.9	0.088	65.0	0.148	-100.5	14.2
700	0.543	-178.2	3.692	81.7	0.099	65.8	0.139	-102.3	13.0
800	0.545	178.7	3.258	78.8	0.111	66.4	0.131	-103.2	11.9
900	0.548	176.0	2.917	76.1	0.122	67.0	0.123	-103.6	10.9
1000	0.552	173.2	2.644	73.8	0.133	67.4	0.114	-104.8	10.1
1200	0.565	168.6	2.233	69.2	0.154	68.0	0.101	-112.5	8.7
1400	0.577	165.0	1.948	64.9	0.175	68.2	0.105	-121.9	7.6
1600	0.584	161.7	1.734	60.8	0.195	67.5	0.119	-125.4	6.7
1800	0.586	157.9	1.577	57.3	0.214	67.3	0.125	-125.0	5.8
2000	0.598	153.6	1.451	54.2	0.234	67.3	0.124	-128.3	5.2
2200	0.620	150.3	1.345	51.5	0.252	67.5	0.129	-137.0	4.8
2400	0.639	148.1	1.251	48.7	0.269	67.5	0.152	-144.6	4.3
2600	0.646	146.3	1.169	46.0	0.284	66.6	0.181	-146.1	3.8
2800	0.642	143.4	1.118	43.0	0.300	66.2	0.200	-144.7	3.4
3000	0.644	139.8	1.071	40.5	0.321	65.7	0.210	-145.0	3.1

**Table 8** Noise data:  $V_{CE} = -5\text{ V}$ ;  $I_C = -30\text{ mA}$ .

f (MHz)	F <sub>min</sub> (dB)	Γ <sub>opt</sub>		R <sub>n</sub>
		(ratio)	(deg)	
500	3.40	0.308	104.2	0.830
1000	4.20	0.380	164.0	0.310

## PNP 4 GHz wideband transistor

## BFT93W

**Table 9** Common emitter scattering parameters:  $V_{CE} = -10$  V;  $I_C = -5$  mA.

f (MHz)	S <sub>11</sub>		S <sub>21</sub>		S <sub>12</sub>		S <sub>22</sub>		G <sub>UM</sub> (dB)
	MAGNITUDE (ratio)	ANGLE (deg)	MAGNITUDE (ratio)	ANGLE (deg)	MAGNITUDE (ratio)	ANGLE (deg)	MAGNITUDE (ratio)	ANGLE (deg)	
40	0.837	-16.8	11.098	166.4	0.020	80.4	0.947	-10.2	36.0
100	0.781	-40.2	10.061	150.4	0.046	67.6	0.856	-23.6	29.9
200	0.670	-73.9	8.331	130.4	0.073	54.7	0.674	-38.2	23.6
300	0.592	-98.6	6.727	116.7	0.088	48.3	0.537	-46.3	19.9
400	0.547	-116.1	5.490	107.3	0.098	45.8	0.447	-51.2	17.3
500	0.523	-128.7	4.616	100.5	0.106	45.2	0.389	-54.5	15.4
600	0.507	-138.6	3.971	94.9	0.114	45.6	0.352	-56.5	13.8
700	0.495	-146.1	3.476	90.3	0.121	46.4	0.327	-57.6	12.5
800	0.487	-152.5	3.094	86.3	0.129	47.3	0.309	-58.0	11.4
900	0.481	-158.1	2.782	82.6	0.136	48.2	0.294	-57.8	10.4
1000	0.478	-163.1	2.532	79.5	0.143	49.3	0.279	-57.8	9.5
1200	0.483	-171.8	2.155	73.7	0.156	51.0	0.250	-59.2	8.1
1400	0.493	-178.2	1.895	68.4	0.171	52.4	0.234	-63.8	7.0
1600	0.499	176.9	1.694	63.6	0.185	53.2	0.232	-69.2	6.1
1800	0.501	172.0	1.541	59.6	0.198	54.4	0.233	-71.8	5.3
2000	0.509	166.5	1.418	55.9	0.212	55.5	0.227	-74.1	4.6
2200	0.529	161.8	1.317	52.6	0.224	56.5	0.215	-79.5	4.0
2400	0.550	158.8	1.228	49.0	0.236	57.2	0.215	-88.7	3.6
2600	0.564	156.7	1.148	45.9	0.246	57.5	0.232	-96.4	3.1
2800	0.564	153.7	1.100	42.8	0.259	58.2	0.253	-100.1	2.8
3000	0.569	150.0	1.051	40.2	0.274	58.9	0.262	-102.7	2.4

**Table 10** Noise data:  $V_{CE} = -10$  V;  $I_C = -5$  mA.

f (MHz)	F <sub>min</sub> (dB)	Γ <sub>opt</sub>		R <sub>n</sub>
		(ratio)	(deg)	
500	2.00	0.340	73.0	0.440
1000	2.50	0.380	105.0	0.360



## PNP 4 GHz wideband transistor

## BFT93W

**Table 11** Common emitter scattering parameters:  $V_{CE} = -10$  V;  $I_C = -10$  mA.

f (MHz)	S <sub>11</sub>		S <sub>21</sub>		S <sub>12</sub>		S <sub>22</sub>		G <sub>UM</sub> (dB)
	MAGNITUDE (ratio)	ANGLE (deg)	MAGNITUDE (ratio)	ANGLE (deg)	MAGNITUDE (ratio)	ANGLE (deg)	MAGNITUDE (ratio)	ANGLE (deg)	
40	0.744	-24.2	18.034	162.0	0.019	77.2	0.902	-15.2	35.9
100	0.666	-56.4	15.339	142.3	0.040	63.6	0.757	-33.0	30.0
200	0.556	-95.4	11.171	121.0	0.059	53.5	0.533	-49.6	24.0
300	0.507	-119.1	8.353	109.0	0.071	50.8	0.398	-57.9	20.5
400	0.485	-134.4	6.576	101.2	0.081	51.0	0.319	-63.2	18.0
500	0.474	-144.5	5.412	95.6	0.090	52.2	0.272	-66.9	16.1
600	0.469	-152.4	4.597	91.1	0.099	53.7	0.243	-69.2	14.6
700	0.465	-158.4	3.997	87.2	0.108	54.9	0.224	-70.3	13.3
800	0.461	-163.5	3.537	83.9	0.118	56.1	0.209	-70.3	12.2
900	0.459	-168.1	3.170	80.8	0.128	57.0	0.196	-69.7	11.2
1000	0.460	-172.3	2.875	78.2	0.137	57.8	0.183	-69.3	10.4
1200	0.469	-179.3	2.435	73.1	0.155	59.1	0.157	-71.0	8.9
1400	0.482	175.4	2.130	68.4	0.173	59.8	0.144	-77.4	7.8
1600	0.488	171.5	1.898	64.1	0.191	59.7	0.147	-83.7	6.8
1800	0.489	167.2	1.723	60.4	0.207	59.9	0.150	-85.2	6.0
2000	0.501	162.2	1.584	57.0	0.224	60.3	0.144	-87.1	5.3
2200	0.522	158.0	1.469	54.0	0.239	60.6	0.134	-94.3	4.8
2400	0.543	155.4	1.367	50.7	0.253	60.7	0.140	-106.3	4.3
2600	0.557	153.8	1.278	47.8	0.264	60.3	0.162	-113.7	3.9
2800	0.556	151.0	1.222	44.7	0.278	60.4	0.183	-115.3	3.5
3000	0.560	147.6	1.168	42.1	0.295	60.4	0.192	-116.6	3.1

**Table 12** Noise data:  $V_{CE} = -10$  V;  $I_C = -10$  mA.

f (MHz)	F <sub>min</sub> (dB)	Γ <sub>opt</sub>		R <sub>n</sub>
		(ratio)	(deg)	
500	2.40	0.270	83.0	0.400
1000	2.90	0.350	115.0	0.350

PNP 4 GHz wideband transistor

BFT93W

**Table 13** Common emitter scattering parameters:  $V_{CE} = -10$  V;  $I_C = -20$  mA.

f (MHz)	S <sub>11</sub>		S <sub>21</sub>		S <sub>12</sub>		S <sub>22</sub>		G <sub>UM</sub> (dB)
	MAGNITUDE (ratio)	ANGLE (deg)	MAGNITUDE (ratio)	ANGLE (deg)	MAGNITUDE (ratio)	ANGLE (deg)	MAGNITUDE (ratio)	ANGLE (deg)	
40	0.655	-33.6	25.207	156.9	0.018	74.2	0.840	-20.3	35.8
100	0.568	-73.8	19.459	133.9	0.035	61.0	0.644	-41.3	29.8
200	0.487	-113.4	12.634	113.7	0.050	54.9	0.416	-58.0	24.0
300	0.463	-134.1	9.050	103.5	0.061	55.1	0.299	-66.3	20.6
400	0.456	-146.7	6.997	96.9	0.072	56.9	0.236	-72.0	18.2
500	0.453	-154.7	5.702	92.1	0.082	58.5	0.200	-76.3	16.3
600	0.453	-161.0	4.818	88.2	0.093	60.0	0.179	-79.0	14.8
700	0.451	-165.7	4.171	84.8	0.104	61.0	0.165	-79.9	13.5
800	0.451	-169.9	3.683	81.8	0.115	61.8	0.155	-79.9	12.4
900	0.452	-173.7	3.297	79.0	0.126	62.4	0.143	-79.0	11.4
1000	0.454	-177.3	2.986	76.6	0.137	62.9	0.132	-78.5	10.6
1200	0.467	176.6	2.521	71.9	0.157	63.4	0.110	-81.6	9.2
1400	0.482	172.4	2.200	67.6	0.176	63.4	0.103	-90.5	8.0
1600	0.490	168.8	1.956	63.6	0.195	62.8	0.110	-97.4	7.1
1800	0.493	164.8	1.774	60.1	0.212	62.7	0.114	-98.0	6.2
2000	0.505	159.8	1.630	56.8	0.230	62.7	0.109	-100.1	5.6
2200	0.528	155.9	1.509	54.1	0.245	62.8	0.103	-109.7	5.0
2400	0.550	153.6	1.405	51.0	0.260	62.7	0.115	-122.8	4.6
2600	0.563	151.9	1.312	48.1	0.273	62.2	0.141	-128.2	4.1
2800	0.562	149.2	1.253	45.2	0.287	62.0	0.160	-127.8	3.7
3000	0.565	145.8	1.199	42.6	0.305	61.7	0.169	-128.3	3.4

**Table 14** Noise data:  $V_{CE} = -10$  V;  $I_C = -20$  mA.

f (MHz)	F <sub>min</sub> (dB)	Γ <sub>opt</sub>		R <sub>n</sub>
		(ratio)	(deg)	
500	3.00	0.240	98.0	0.440
1000	3.60	0.320	131.0	0.400

PNP 4 GHz wideband transistor

BFT93W

**Table 15** Common emitter scattering parameters:  $V_{CE} = -10$  V;  $I_C = -30$  mA.

f (MHz)	S <sub>11</sub>		S <sub>21</sub>		S <sub>12</sub>		S <sub>22</sub>		G <sub>UM</sub> (dB)
	MAGNITUDE (ratio)	ANGLE (deg)	MAGNITUDE (ratio)	ANGLE (deg)	MAGNITUDE (ratio)	ANGLE (deg)	MAGNITUDE (ratio)	ANGLE (deg)	
40	0.617	-39.1	28.045	153.9	0.017	73.1	0.797	-22.6	35.4
100	0.529	-82.4	20.389	129.6	0.032	60.3	0.583	-44.1	29.4
200	0.464	-120.8	12.630	110.4	0.047	56.4	0.364	-59.3	23.7
300	0.449	-139.7	8.920	101.0	0.058	57.3	0.259	-66.3	20.3
400	0.446	-151.0	6.853	94.8	0.069	59.4	0.204	-71.2	17.9
500	0.446	-158.1	5.569	90.3	0.081	60.9	0.174	-75.0	16.0
600	0.448	-163.5	4.694	86.5	0.092	62.2	0.158	-77.2	14.5
700	0.449	-167.8	4.060	83.3	0.103	63.0	0.147	-77.7	13.2
800	0.450	-171.7	3.579	80.4	0.115	63.6	0.139	-77.1	12.1
900	0.452	-175.1	3.204	77.7	0.126	63.8	0.131	-75.9	11.2
1000	0.456	-178.5	2.902	75.4	0.136	64.1	0.122	-75.0	10.3
1200	0.472	175.9	2.448	70.8	0.157	64.3	0.103	-77.7	8.9
1400	0.488	171.7	2.134	66.6	0.176	64.2	0.097	-87.1	7.8
1600	0.498	168.1	1.898	62.5	0.194	63.6	0.106	-94.6	6.9
1800	0.502	164.0	1.721	59.1	0.211	63.4	0.112	-95.7	6.0
2000	0.516	159.3	1.580	56.0	0.229	63.5	0.108	-98.0	5.4
2200	0.539	155.4	1.464	53.2	0.245	63.7	0.103	-108.1	4.8
2400	0.562	152.9	1.362	50.2	0.260	63.6	0.116	-121.5	4.4
2600	0.575	151.2	1.273	47.4	0.272	63.0	0.141	-127.4	3.9
2800	0.573	148.4	1.217	44.5	0.287	62.9	0.162	-127.3	3.5
3000	0.576	144.7	1.164	42.0	0.305	62.6	0.172	-128.1	3.2

**Table 16** Noise data:  $V_{CE} = -10$  V;  $I_C = -30$  mA.

f (MHz)	F <sub>min</sub> (dB)	Γ <sub>opt</sub>		R <sub>n</sub>
		(ratio)	(deg)	
500	3.60	0.250	101.0	0.550
1000	4.20	0.310	143.0	0.480

PNP 4 GHz wideband transistor

BFT93W

PACKAGE OUTLINE

Plastic surface-mounted package; 3 leads

SOT323

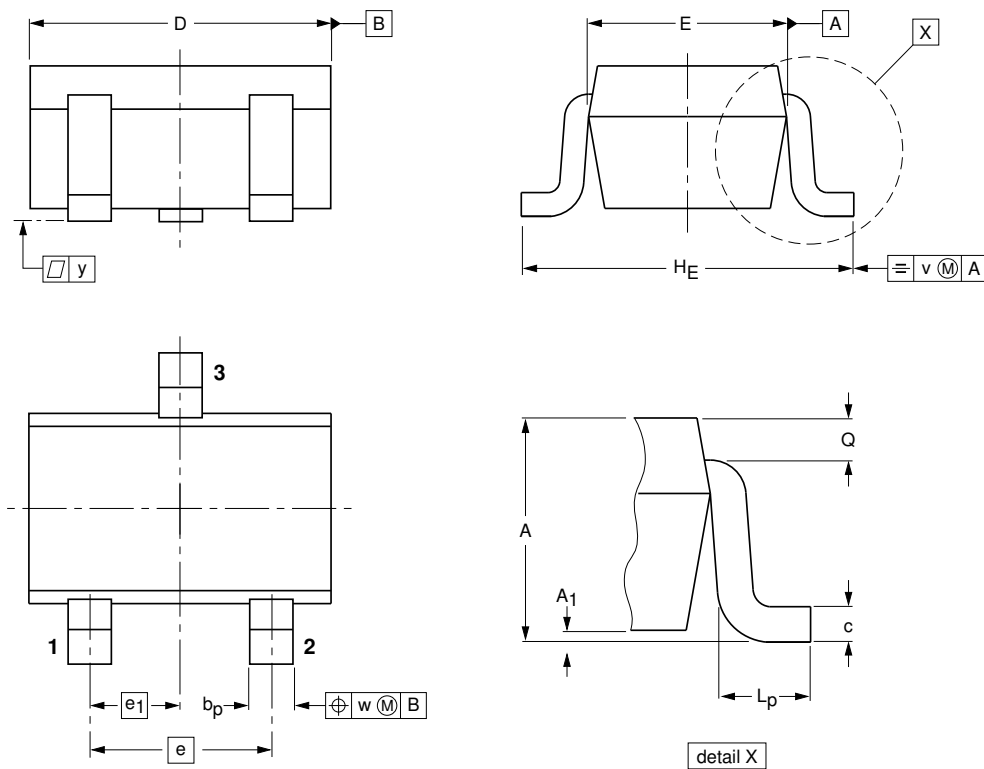

DIMENSIONS (mm are the original dimensions)

UNIT	A	A <sub>1</sub> max	b <sub>p</sub>	c	D	E	e	e <sub>1</sub>	H <sub>E</sub>	L <sub>p</sub>	Q	v	w
mm	1.1 0.8	0.1	0.4 0.3	0.25 0.10	2.2 1.8	1.35 1.15	1.3	0.65	2.2 2.0	0.45 0.15	0.23 0.13	0.2	0.2

OUTLINE VERSION	REFERENCES				EUROPEAN PROJECTION	ISSUE DATE
	IEC	JEDEC	JEITA			
SOT323			SC-70			04-11-04 06-03-16

## PNP 4 GHz wideband transistor

BFT93W

## DATA SHEET STATUS

DOCUMENT STATUS <sup>(1)</sup>	PRODUCT STATUS <sup>(2)</sup>	DEFINITION
Objective data sheet	Development	This document contains data from the objective specification for product development.
Preliminary data sheet	Qualification	This document contains data from the preliminary specification.
Product data sheet	Production	This document contains the product specification.

## Notes

1. Please consult the most recently issued document before initiating or completing a design.
2. The product status of device(s) described in this document may have changed since this document was published and may differ in case of multiple devices. The latest product status information is available on the Internet at URL <http://www.nxp.com>.

## DEFINITIONS

**Product specification** — The information and data provided in a Product data sheet shall define the specification of the product as agreed between NXP Semiconductors and its customer, unless NXP Semiconductors and customer have explicitly agreed otherwise in writing. In no event however, shall an agreement be valid in which the NXP Semiconductors product is deemed to offer functions and qualities beyond those described in the Product data sheet.

## DISCLAIMERS

**Limited warranty and liability** — Information in this document is believed to be accurate and reliable. However, NXP Semiconductors does not give any representations or warranties, expressed or implied, as to the accuracy or completeness of such information and shall have no liability for the consequences of use of such information.

In no event shall NXP Semiconductors be liable for any indirect, incidental, punitive, special or consequential damages (including - without limitation - lost profits, lost savings, business interruption, costs related to the removal or replacement of any products or rework charges) whether or not such damages are based on tort (including negligence), warranty, breach of contract or any other legal theory.

Notwithstanding any damages that customer might incur for any reason whatsoever, NXP Semiconductors' aggregate and cumulative liability towards customer for the products described herein shall be limited in accordance with the *Terms and conditions of commercial sale* of NXP Semiconductors.

**Right to make changes** — NXP Semiconductors reserves the right to make changes to information published in this document, including without limitation specifications and product descriptions, at any time and without notice. This document supersedes and replaces all information supplied prior to the publication hereof.

**Suitability for use** — NXP Semiconductors products are not designed, authorized or warranted to be suitable for use in life support, life-critical or safety-critical systems or equipment, nor in applications where failure or malfunction of an NXP Semiconductors product can reasonably be expected to result in personal injury, death or severe property or environmental damage. NXP Semiconductors accepts no liability for inclusion and/or use of NXP Semiconductors products in such equipment or applications and therefore such inclusion and/or use is at the customer's own risk.

**Applications** — Applications that are described herein for any of these products are for illustrative purposes only. NXP Semiconductors makes no representation or warranty that such applications will be suitable for the specified use without further testing or modification.

Customers are responsible for the design and operation of their applications and products using NXP Semiconductors products, and NXP Semiconductors accepts no liability for any assistance with applications or customer product design. It is customer's sole responsibility to determine whether the NXP Semiconductors product is suitable and fit for the customer's applications and products planned, as well as for the planned application and use of customer's third party customer(s). Customers should provide appropriate design and operating safeguards to minimize the risks associated with their applications and products.

---

## PNP 4 GHz wideband transistor

## BFT93W

---

NXP Semiconductors does not accept any liability related to any default, damage, costs or problem which is based on any weakness or default in the customer's applications or products, or the application or use by customer's third party customer(s). Customer is responsible for doing all necessary testing for the customer's applications and products using NXP Semiconductors products in order to avoid a default of the applications and the products or of the application or use by customer's third party customer(s). NXP does not accept any liability in this respect.

**Limiting values** — Stress above one or more limiting values (as defined in the Absolute Maximum Ratings System of IEC 60134) will cause permanent damage to the device. Limiting values are stress ratings only and (proper) operation of the device at these or any other conditions above those given in the Recommended operating conditions section (if present) or the Characteristics sections of this document is not warranted. Constant or repeated exposure to limiting values will permanently and irreversibly affect the quality and reliability of the device.

**Terms and conditions of commercial sale** — NXP Semiconductors products are sold subject to the general terms and conditions of commercial sale, as published at <http://www.nxp.com/profile/terms>, unless otherwise agreed in a valid written individual agreement. In case an individual agreement is concluded only the terms and conditions of the respective agreement shall apply. NXP Semiconductors hereby expressly objects to applying the customer's general terms and conditions with regard to the purchase of NXP Semiconductors products by customer.

**No offer to sell or license** — Nothing in this document may be interpreted or construed as an offer to sell products that is open for acceptance or the grant, conveyance or implication of any license under any copyrights, patents or other industrial or intellectual property rights.

**Export control** — This document as well as the item(s) described herein may be subject to export control regulations. Export might require a prior authorization from national authorities.

**Quick reference data** — The Quick reference data is an extract of the product data given in the Limiting values and Characteristics sections of this document, and as such is not complete, exhaustive or legally binding.

**Non-automotive qualified products** — Unless this data sheet expressly states that this specific NXP Semiconductors product is automotive qualified, the product is not suitable for automotive use. It is neither qualified nor tested in accordance with automotive testing or application requirements. NXP Semiconductors accepts no liability for inclusion and/or use of non-automotive qualified products in automotive equipment or applications.

In the event that customer uses the product for design-in and use in automotive applications to automotive specifications and standards, customer (a) shall use the product without NXP Semiconductors' warranty of the product for such automotive applications, use and specifications, and (b) whenever customer uses the product for automotive applications beyond NXP Semiconductors' specifications such use shall be solely at customer's own risk, and (c) customer fully indemnifies NXP Semiconductors for any liability, damages or failed product claims resulting from customer design and use of the product for automotive applications beyond NXP Semiconductors' standard warranty and NXP Semiconductors' product specifications.

# ***NXP Semiconductors***

***provides High Performance Mixed Signal and Standard Product solutions that leverage its leading RF, Analog, Power Management, Interface, Security and Digital Processing expertise***

## **Customer notification**

This data sheet was changed to reflect the new company name NXP Semiconductors, including new legal definitions and disclaimers. No changes were made to the technical content, except for package outline drawings which were updated to the latest version.

## **Contact information**

For additional information please visit: **<http://www.nxp.com>**

For sales offices addresses send e-mail to: **[salesaddresses@nxp.com](mailto:salesaddresses@nxp.com)**

© NXP B.V. 2010

All rights are reserved. Reproduction in whole or in part is prohibited without the prior written consent of the copyright owner.

The information presented in this document does not form part of any quotation or contract, is believed to be accurate and reliable and may be changed without notice. No liability will be accepted by the publisher for any consequence of its use. Publication thereof does not convey nor imply any license under patent- or other industrial or intellectual property rights.

Printed in The Netherlands

R77/01/pp22

Date of release: March 1994