



Chipsmall Limited consists of a professional team with an average of over 10 year of expertise in the distribution of electronic components. Based in Hongkong, we have already established firm and mutual-benefit business relationships with customers from,Europe,America and south Asia,supplying obsolete and hard-to-find components to meet their specific needs.

With the principle of “Quality Parts,Customers Priority,Honest Operation,and Considerate Service”,our business mainly focus on the distribution of electronic components. Line cards we deal with include Microchip,ALPS,ROHM,Xilinx,Pulse,ON,Everlight and Freescale. Main products comprise IC,Modules,Potentiometer,IC Socket,Relay,Connector.Our parts cover such applications as commercial,industrial, and automotives areas.

We are looking forward to setting up business relationship with you and hope to provide you with the best service and solution. Let us make a better world for our industry!



## Contact us

Tel: +86-755-8981 8866 Fax: +86-755-8427 6832

Email & Skype: info@chipsmall.com Web: www.chipsmall.com

Address: A1208, Overseas Decoration Building, #122 Zhenhua RD., Futian, Shenzhen, China





# BGA734L16

Low Power Tri-Band UMTS LNA (2100, 1900, 800 MHz)

## Data Sheet

Revision 1.1, 2011-03-16

**Edition 2011-03-16**

**Published by  
Infineon Technologies AG  
81726 Munich, Germany**

**© 2011 Infineon Technologies AG  
All Rights Reserved.**

### **Legal Disclaimer**

The information given in this document shall in no event be regarded as a guarantee of conditions or characteristics. With respect to any examples or hints given herein, any typical values stated herein and/or any information regarding the application of the device, Infineon Technologies hereby disclaims any and all warranties and liabilities of any kind, including without limitation, warranties of non-infringement of intellectual property rights of any third party.

### **Information**

For further information on technology, delivery terms and conditions and prices, please contact the nearest Infineon Technologies Office ([www.infineon.com](http://www.infineon.com)).

### **Warnings**

Due to technical requirements, components may contain dangerous substances. For information on the types in question, please contact the nearest Infineon Technologies Office.

Infineon Technologies components may be used in life-support devices or systems only with the express written approval of Infineon Technologies, if a failure of such components can reasonably be expected to cause the failure of that life-support device or system or to affect the safety or effectiveness of that device or system. Life support devices or systems are intended to be implanted in the human body or to support and/or maintain and sustain and/or protect human life. If they fail, it is reasonable to assume that the health of the user or other persons may be endangered.

**BGA734L16 Low Power Tri-Band UMTS LNA (2100, 1900, 800 MHz)**

**Revision History: 2011-03-16, Revision 1.1**

**Previous Revision: 2008-01-25, Revision 1.0**

Page	Subjects (major changes since last revision)
10	Updated Logic Level Limit

**Trademarks of Infineon Technologies AG**

AURIX™, BlueMoon™, C166™, CanPAK™, CIPOS™, CIPURSE™, COMNEON™, EconoPACK™, CoolMOS™, CoolSET™, CORECONTROL™, CROSSAVE™, DAVE™, EasyPIM™, EconoBRIDGE™, EconoDUAL™, EconoPIM™, EiceDRIVER™, eupec™, FCOS™, HITFET™, HybridPACK™, I<sup>2</sup>RF™, ISOFACE™, IsoPACK™, MIPAQ™, ModSTACK™, my-d™, NovalithIC™, OmniTune™, OptiMOS™, ORIGA™, PRIMARION™, PrimePACK™, PrimeSTACK™, PRO-SIL™, PROFET™, RASIC™, ReverSave™, SatRIC™, SIEGET™, SINDRION™, SIPMOS™, SMARTi™, SmartLEWIS™, SOLID FLASH™, TEMPFET™, thinQ!™, TRENCHSTOP™, TriCore™, X-GOLD™, X-PMU™, XMM™, XPOSYS™

**Other Trademarks**

Advance Design System™ (ADS) of Agilent Technologies, AMBA™, ARM™, MULTI-ICE™, KEIL™, PRIMECELL™, REALVIEW™, THUMB™, μVision™ of ARM Limited, UK. AUTOSAR™ is licensed by AUTOSAR development partnership. Bluetooth™ of Bluetooth SIG Inc. CAT-iq™ of DECT Forum. COLOSSUS™, FirstGPS™ of Trimble Navigation Ltd. EMV™ of EMVCo, LLC (Visa Holdings Inc.). EPCOS™ of Epcos AG. FLEXGO™ of Microsoft Corporation. FlexRay™ is licensed by FlexRay Consortium. HYPERTERMINAL™ of Hilgraeve Incorporated. IEC™ of Commission Electrotechnique Internationale. IrDA™ of Infrared Data Association Corporation. ISO™ of INTERNATIONAL ORGANIZATION FOR STANDARDIZATION. MATLAB™ of MathWorks, Inc. MAXIM™ of Maxim Integrated Products, Inc. MICROTEC™, NUCLEUS™ of Mentor Graphics Corporation. Mifare™ of NXP. MIPI™ of MIPI Alliance, Inc. MIPS™ of MIPS Technologies, Inc., USA. muRata™ of MURATA MANUFACTURING CO., MICROWAVE OFFICE™ (MWO) of Applied Wave Research Inc., OmniVision™ of OmniVision Technologies, Inc. Openwave™ Openwave Systems Inc. RED HAT™ Red Hat, Inc. RFMD™ RF Micro Devices, Inc. SIRIUS™ of Sirius Satellite Radio Inc. SOLARIS™ of Sun Microsystems, Inc. SPANSION™ of Spansion LLC Ltd. Symbian™ of Symbian Software Limited. TAIYO YUDEN™ of Taiyo Yuden Co. TEAKLITE™ of CEVA, Inc. TEKTRONIX™ of Tektronix Inc. TOKO™ of TOKO KABUSHIKI KAISHA TA. UNIX™ of X/Open Company Limited. VERILOG™, PALLADIUM™ of Cadence Design Systems, Inc. VLYNQ™ of Texas Instruments Incorporated. VXWORKS™, WIND RIVER™ of WIND RIVER SYSTEMS, INC. ZETEX™ of Diodes Zetex Limited.

Last Trademarks Update 2010-10-26

## Table of Contents

	<b>Table of Contents</b> .....	4
<b>1</b>	<b>Features</b> .....	5
	<b>List of Figures</b> .....	7
	<b>List of Tables</b> .....	8
<b>2</b>	<b>Electrical Characteristics</b> .....	9
2.1	Absolute Maximum Ratings .....	9
2.2	Thermal Resistance .....	9
2.3	ESD Integrity .....	9
2.4	DC Characteristics .....	10
2.5	Band Select / Gain Control Truth Table .....	10
2.6	Logic Signal Characteristics; $T_A = 25\text{ }^\circ\text{C}$ .....	11
2.7	Switching Times .....	11
2.8	Measured RF Characteristics UMTS Band 5 .....	12
2.9	Measured RF Characteristics UMTS Band 2 .....	13
2.10	Measured RF Characteristics UMTS Band 1 .....	14
2.11	Measured Performance Low Band High Gain Mode vs. Frequency .....	15
2.12	Measured Performance Low Band High Gain Mode vs. Temperature .....	17
2.13	Measured Performance Low Band Low Gain Mode vs. Frequency .....	18
2.14	Measured Performance Low Band Low Gain Mode vs. Temperature .....	20
2.15	Measured Performance Mid Band High Gain Mode vs. Frequency .....	21
2.16	Measured Performance Mid Band High Gain Mode vs. Temperature .....	23
2.17	Measured Performance Mid Band Low Gain Mode vs. Frequency .....	24
2.18	Measured Performance Mid Band Low Gain Mode vs. Temperature .....	26
2.19	Measured Performance High Band High Gain Mode vs. Frequency .....	27
2.20	Measured Performance High Band High Gain Mode vs. Temperature .....	29
2.21	Measured Performance High Band Low Gain Mode vs. Frequency .....	30
2.22	Measured Performance High Band Low Gain Mode vs. Temperature .....	32
<b>3</b>	<b>Application Circuit and Block Diagram</b> .....	33
3.1	UMTS Bands 1, 2 and 5 Application Circuit Schematic .....	33
3.2	Pin Description .....	34
3.3	Application Board .....	35
<b>4</b>	<b>Physical Characteristics</b> .....	37
4.1	Package Footprint .....	37
4.2	Package Dimensions .....	38

## 1 Features

Main features:

- Gain: 15 / -8 dB in high / low gain
- Noise figure: 1.2 dB in high gain mode
- Low Band (5, 6, 8, FOMA800)
- Mid Band (2, 3, 9, FOMA1700)
- High Band (1, 4, 10)
- High and low gain modes support
- Supply current: 3.5 / 0.65 mA in high / low gain modes
- Standby mode (<10  $\mu$ A typ)
- 1 kV HBM ESD protection
- Small leadless TSLP-16-1 package (2.3 x 2.3 x 0.39 mm)
- Pb-free (RoHS compliant) package

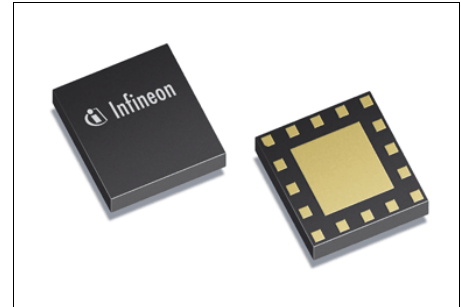

### Description

The BGA734L16 is a highly flexible tri-band (2100, 1900, 850/800 MHz) low noise amplifier MMIC for worldwide use. Based on Infineon's proprietary and cost-effective SiGe:C technology, the BGA734L16 features dynamic gain control, temperature stabilization, standby mode, and 1 kV ESD protection on-chip and matching off chip. Because the matching is off chip, the 1900 MHz path can be converted into a 2100 MHz path and vice versa by optimizing the input and output matching network. This document specifies device performance for the most common band combination - UMTS bands I, II, and V.

Product Name	Package	Chip	Marking
BGA734L16	TSLP-16-1	T1520	BGA734

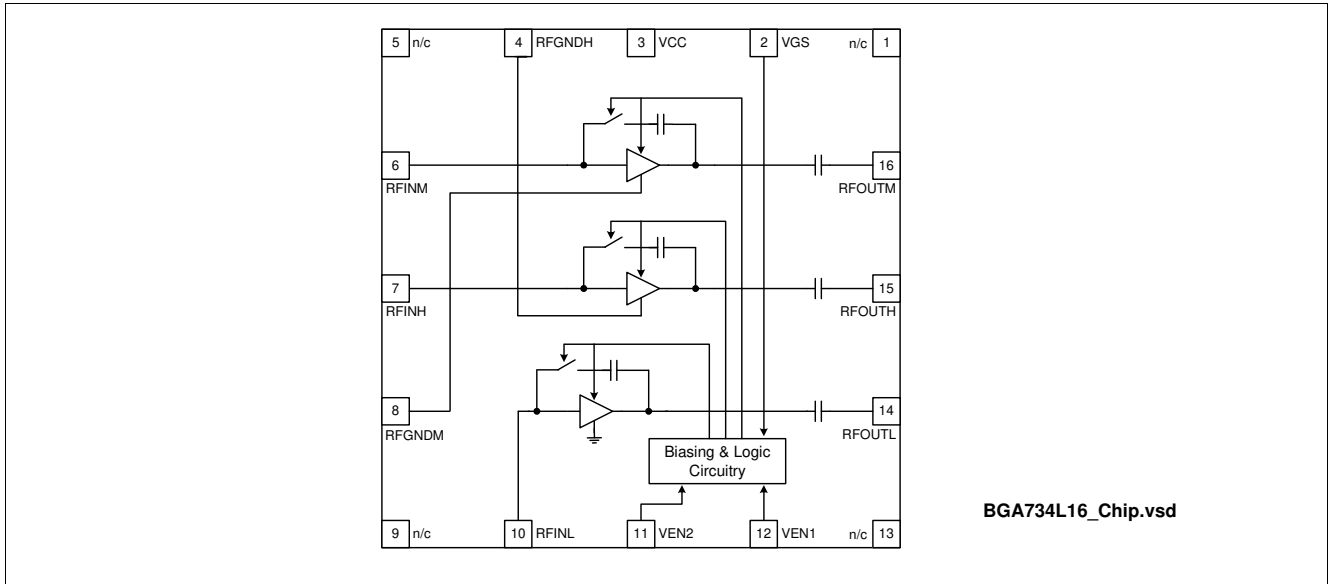

**Figure 1** Block Diagram of Triple-Band LNA

## List of Figures

Figure 1	Block Diagram of Triple-Band LNA. . . . .	6
Figure 2	Application Circuit with Chip Outline (Top View) . . . . .	33
Figure 3	Application Board Layout on 3-layer FR4. . . . .	35
Figure 4	Cross-Section View of Application Board. . . . .	35
Figure 5	Detail of Application Board Layout . . . . .	36
Figure 6	Recommended Footprint and Stencil Layout for the TSLP-16-1 Package. . . . .	37
Figure 7	Package Outline (Top, Side and Bottom View) . . . . .	38



## List of Tables

Table 1	Absolute Maximum Ratings .....	9
Table 2	Thermal Resistance .....	9
Table 3	ESD Integrity .....	9
Table 4	DC Characteristics, $T_A = -30 \dots 85 \text{ }^\circ\text{C}$ .....	10
Table 5	Band Select Truth Table, $V_{CC} = 2.8 \text{ V}$ .....	10
Table 6	Gain Control Truth Table, $V_{CC} = 2.8 \text{ V}$ .....	10
Table 7	Typical Switching Times; $T_A = -30 \dots 85 \text{ }^\circ\text{C}$ .....	11
Table 8	Typical Characteristics 800 MHz Band, $T_A = 25 \text{ }^\circ\text{C}$ , $V_{CC} = 2.8 \text{ V}$ .....	12
Table 9	Typical Characteristics 1900 MHz Band, $T_A = 25 \text{ }^\circ\text{C}$ , $V_{CC} = 2.8 \text{ V}$ .....	13
Table 10	Typical Characteristics 2100 MHz Band, $T_A = 25 \text{ }^\circ\text{C}$ , $V_{CC} = 2.8 \text{ V}$ .....	14
Table 11	Bill of Materials .....	33
Table 12	Pin Definition and Function .....	34

## 2 Electrical Characteristics

### 2.1 Absolute Maximum Ratings

**Table 1 Absolute Maximum Ratings**

Parameter	Symbol	Values			Unit	Note / Test Condition
		Min.	Typ.	Max.		
Supply voltage	$V_{CC}$	-0.3	–	3.6	V	–
Supply current	$I_{CC}$		–	5	mA	–
Pin voltage	$V_{PIN}$	-0.3	–	$V_{CC}+0.3$	V	All pins except RF input pins.
Pin voltage RF input pins	$V_{RFIN}$	-0.3	–	0.9	V	–
RF input power	$P_{RFIN}$		–	4	dBm	–
Junction temperature	$T_j$		–	150	°C	–
Ambient temperature range	$T_A$	-30	–	85	°C	–
Storage temperature range	$T_{STG}$	-65	–	150	°C	–

### 2.2 Thermal Resistance

**Table 2 Thermal Resistance**

Parameter	Symbol	Values			Unit	Note / Test Condition
		Min.	Typ.	Max.		
Thermal resistance junction to soldering point	$R_{thJS}$	–	–	≤ 110	K/W	–

### 2.3 ESD Integrity

**Table 3 ESD Integrity**

Parameter	Symbol	Values			Unit	Note / Test Condition
		Min.	Typ.	Max.		
ESD hardness HBM <sup>1)</sup>	$V_{ESD-HBM}$	–	1000	–	V	All pins

1) According to JESD22-A114

## 2.4 DC Characteristics

Table 4 DC Characteristics,  $T_A = -30 \dots 85 \text{ }^\circ\text{C}$

Parameter	Symbol	Values			Unit	Note / Test Condition
		Min.	Typ.	Max.		
Supply voltage	$V_{CC}$	2.7	2.8	3.0	V	
Supply current high gain mode	$I_{CCHG}$	–	3.5	–	mA	All bands
Supply current low gain mode	$I_{CCLG}$	–	650	–	$\mu\text{A}$	All bands
Supply current standby mode	$I_{CCOFF}$	–	0.1	2	$\mu\text{A}$	
Logic level high	$V_{HI}$	1.4	2.8	–	V	VEN1 and VEN2
Logic level low	$V_{LOW}$	–	0.0	0.5	V	
Logic currents VEN	$I_{ENL}$	–	0.2	–	$\mu\text{A}$	VEN1 and VEN2
	$I_{ENH}$	–	10.0	–	$\mu\text{A}$	
Logic currents VGS	$I_{GSL}$	–	0.1	–	$\mu\text{A}$	VGS
	$I_{GSH}$	–	5.0	–	$\mu\text{A}$	

## 2.5 Band Select / Gain Control Truth Table

Table 5 Band Select Truth Table,  $V_{CC} = 2.8 \text{ V}$

	Band I	Band II	Band V	Power Down
VCC	H	H	H	H
VEN1	H	H	L	L
VEN2	H	L	H	L

Table 6 Gain Control Truth Table,  $V_{CC} = 2.8 \text{ V}$

	High Gain	Low Gain
VGS	H	L

## 2.6 Logic Signal Characteristics; $T_A = 25\text{ °C}$

Current consumption of logic inputs VEN1, VEN2, VGS

**Logic currents**  $I_{EN1,2} = f(V_{EN1,2})$   
 $V_{CC} = 2.8\text{ V}$

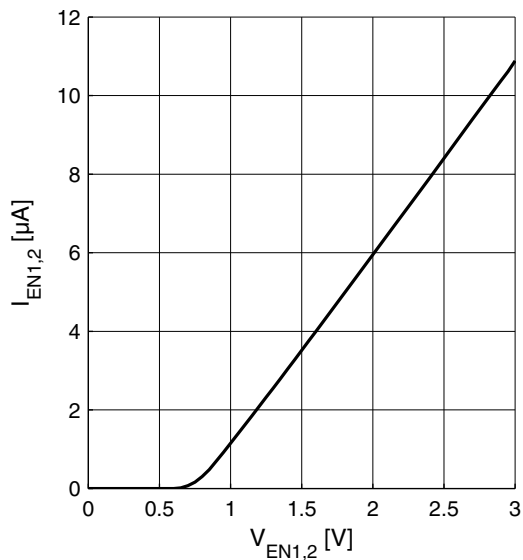

**Logic currents**  $I_{GS} = f(V_{GS})$   
 $V_{CC} = 2.8\text{ V}$

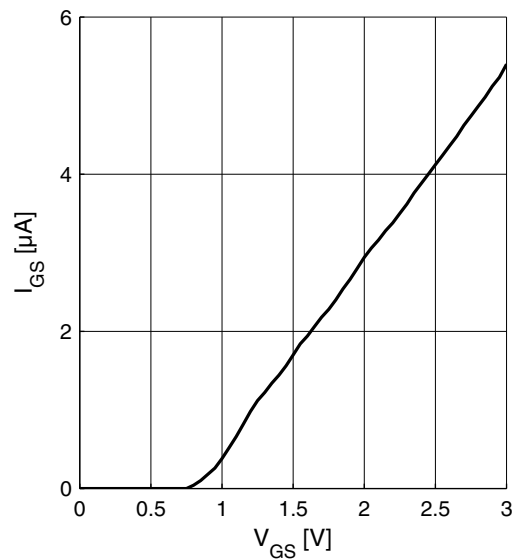

## 2.7 Switching Times

**Table 7** Typical Switching Times;  $T_A = -30 \dots 85\text{ °C}$

Parameter	Symbol	Values			Unit	Note / Test Condition
		Min.	Typ.	Max.		
Gainstep settling time	$t_{GS}$	–	1.2	–	µs	Switching LG ↔ HG all bands
Bandselect settling time	$t_{BS}$	–	1.2	–	µs	Switching from any band to a different band



## 2.8 Measured RF Characteristics UMTS Band 5

**Table 8** Typical Characteristics 800 MHz Band,  $T_A = 25\text{ °C}$ ,  $V_{CC} = 2.8\text{ V}$  <sup>1)</sup>

Parameter	Symbol	Values			Unit	Note / Test Condition
		Min.	Typ.	Max.		
Pass band range		869		894	MHz	
Input power range		-100		0	dBm	
Current consumption	$I_{CCHG}$	–	3.5	–	mA	High gain mode
	$I_{CCLG}$	–	0.65	–	mA	Low gain mode
Gain	$S_{21HG}$	–	15.2	–	dB	High gain mode
	$S_{21LG}$	–	-6.8	–	dB	Low gain mode
Reverse Isolation <sup>2)</sup>	$S_{12HG}$	–	-34	–	dB	High gain mode
	$S_{12LG}$	–	-6.8	–	dB	Low gain mode
Noise figure	$NF_{HG}$	–	1.2	–	dB	High gain mode
	$NF_{LG}$	–	6.9	–	dB	Low gain mode
Input return loss <sup>2)</sup>	$S_{11HG}$	–	-13	–	dB	50 $\Omega$ , high gain mode
	$S_{11LG}$	–	-18	–	dB	50 $\Omega$ , low gain mode
Output return loss <sup>2)</sup>	$S_{22HG}$	–	-24	–	dB	50 $\Omega$ , high gain mode
	$S_{22LG}$	–	-11	–	dB	50 $\Omega$ , low gain mode
Stability factor <sup>3)</sup>	$k$	–	>2.1	–	–	DC to 10 GHz; all gain modes
Input compression point <sup>2)</sup>	$IP_{1dBHG}$	–	-12	–	dBm	High gain mode
	$IP_{1dB LG}$	–	-6	–	dBm	Low gain mode
Inband IIP3 <sup>2)</sup> $f_1 - f_2 = 1\text{ MHz}$ $P_{f1} = P_{f2} = -25\text{ dBm}$	$IIP3_{HG}$	–	-6	–	dBm	High gain mode
	$IIP3_{LG}$	–	5	–	dBm	Low gain mode

1) Performance based on application circuit in Figure 2 on Page 33

2) Verification based on AQL; random production test.

3) Guaranteed by device design; not tested in production.

## 2.9 Measured RF Characteristics UMTS Band 2

Table 9 Typical Characteristics 1900 MHz Band,  $T_A = 25\text{ °C}$ ,  $V_{CC} = 2.8\text{ V}$  <sup>1)</sup>

Parameter	Symbol	Values			Unit	Note / Test Condition
		Min.	Typ.	Max.		
Pass band range		1930		1990	MHz	
Input power range		-100		0	dBm	
Current consumption	$I_{CCHG}$	–	3.4	–	mA	High gain mode
	$I_{CCLG}$	–	0.65	–	mA	Low gain mode
Gain	$S_{21HG}$	–	16.5	–	dB	High gain mode
	$S_{21LG}$	–	-6.9	–	dB	Low gain mode
Reverse Isolation <sup>2)</sup>	$S_{12HG}$	–	-35	–	dB	High gain mode
	$S_{12LG}$	–	-7	–	dB	Low gain mode
Noise figure	$NF_{HG}$	–	1.0	–	dB	High gain mode
	$NF_{LG}$	–	6.8	–	dB	Low gain mode
Input return loss <sup>2)</sup>	$S_{11HG}$	–	-13	–	dB	50 $\Omega$ , high gain mode
	$S_{11LG}$	–	-12	–	dB	50 $\Omega$ , low gain mode
Output return loss <sup>2)</sup>	$S_{22HG}$	–	-20	–	dB	50 $\Omega$ , high gain mode
	$S_{22LG}$	–	-17	–	dB	50 $\Omega$ , low gain mode
Stability factor <sup>3)</sup>	$k$	–	>2.0	–	–	DC to 10 GHz; all gain modes
Input compression point <sup>2)</sup>	$IP_{1dBHG}$	–	-10	–	dBm	High gain mode
	$IP_{1dBLG}$	–	-4	–	dBm	Low gain mode
Inband IIP3 <sup>2)</sup> $f_1 - f_2 = 1\text{ MHz}$ $P_{f1} = P_{f2} = -26\text{ dBm}$	$IIP3_{HG}$	–	-5	–	dBm	High gain mode
	$IIP3_{LG}$	–	6	–	dBm	Low gain mode

1) Performance based on application circuit in Figure 2 on Page 33

2) Verification based on AQL; random production test.

3) Guaranteed by device design; not tested in production.

## 2.10 Measured RF Characteristics UMTS Band 1

Table 10 Typical Characteristics 2100 MHz Band,  $T_A = 25\text{ °C}$ ,  $V_{CC} = 2.8\text{ V}$ <sup>1)</sup>

Parameter	Symbol	Values			Unit	Note / Test Condition
		Min.	Typ.	Max.		
Pass band range		2110		2170	MHz	
Input power range		-100		0	dBm	
Current consumption	$I_{CCHG}$	–	3.5	–	mA	High gain mode
	$I_{CCLG}$	–	0.65	–	mA	Low gain mode
Gain	$S_{21HG}$	–	16.5	–	dB	High gain mode
	$S_{21LG}$	–	-7.7	–	dB	Low gain mode
Reverse Isolation <sup>2)</sup>	$S_{12HG}$	–	-36	–	dB	High gain mode
	$S_{12LG}$	–	-8	–	dB	Low gain mode
Noise figure	$NF_{HG}$	–	1.1	–	dB	High gain mode
	$NF_{LG}$	–	7.4	–	dB	Low gain mode
Input return loss <sup>2)</sup>	$S_{11HG}$	–	-13	–	dB	50 $\Omega$ , high gain mode
	$S_{11LG}$	–	-27	–	dB	50 $\Omega$ , low gain mode
Output return loss <sup>2)</sup>	$S_{22HG}$	–	-18	–	dB	50 $\Omega$ , high gain mode
	$S_{22LG}$	–	-9	–	dB	50 $\Omega$ , low gain mode
Stability factor <sup>3)</sup>	$k$	–	>1.8	–	–	DC to 10 GHz; all gain modes
Input compression point <sup>2)</sup>	$IP_{1dBHG}$	–	-11	–	dBm	High gain mode
	$IP_{1dBLG}$	–	-4	–	dBm	Low gain mode
Inband IIP3 <sup>2)</sup> $f_1 - f_2 = 1\text{ MHz}$ $P_{f1} = P_{f2} = -26\text{ dBm}$	$IIP3_{HG}$	–	-6	–	dBm	High gain mode
	$IIP3_{LG}$	–	7	–	dBm	Low gain mode

1) Performance based on application circuit in Figure 2 on Page 33

2) Verification based on AQL; random production test.

3) Guaranteed by device design; not tested in production.

### 2.11 Measured Performance Low Band High Gain Mode vs. Frequency

$T_A = 25\text{ }^\circ\text{C}$ ,  $V_{CC} = 2.8\text{ V}$ ,  $V_{GS} = 2.8\text{ V}$ ,  $V_{EN1} = 0\text{ V}$ ,  $V_{EN2} = 2.8\text{ V}$

Power Gain  $|S_{21}| = f(f)$

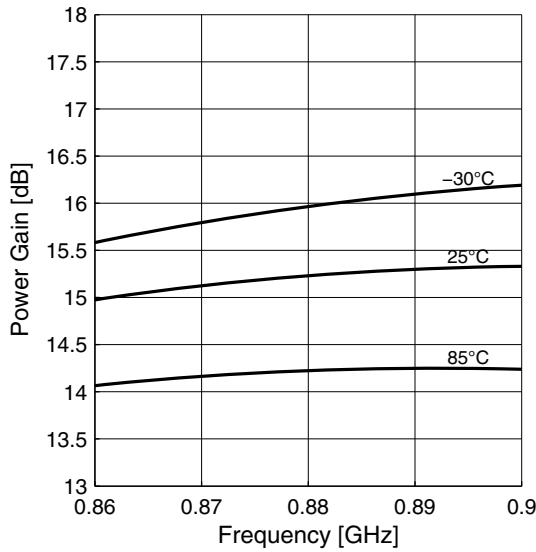

Power Gain Wideband  $|S_{21}| = f(f)$

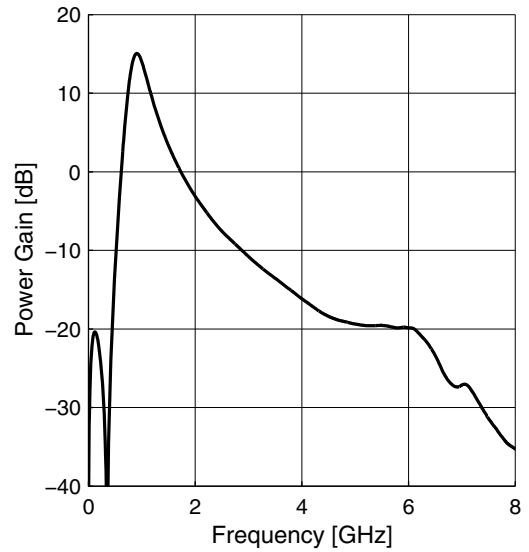

Matching  $|S_{11}| = f(f)$ ,  $|S_{22}| = f(f)$

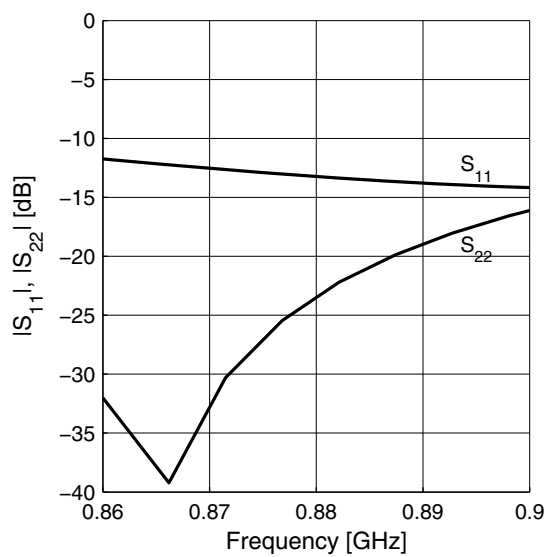

Gainstep HG - LG  $|\Delta S_{21}| = f(f)$

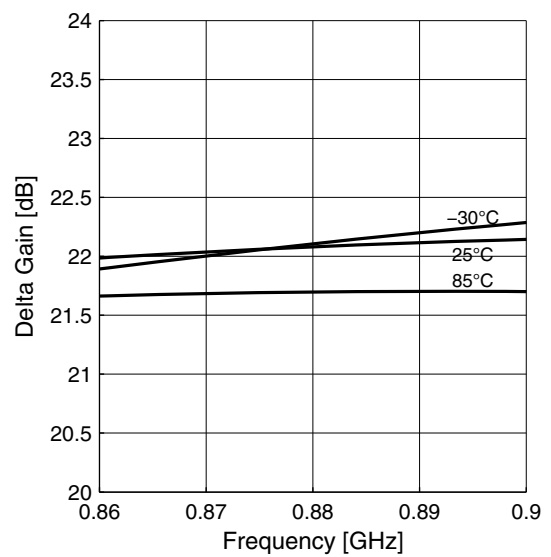



Noise Figure  $NF = f(f)$

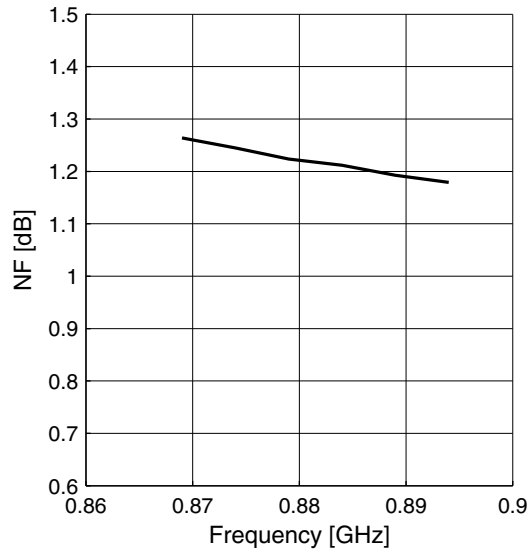

Input Compression  $P_{1dB} = f(f)$

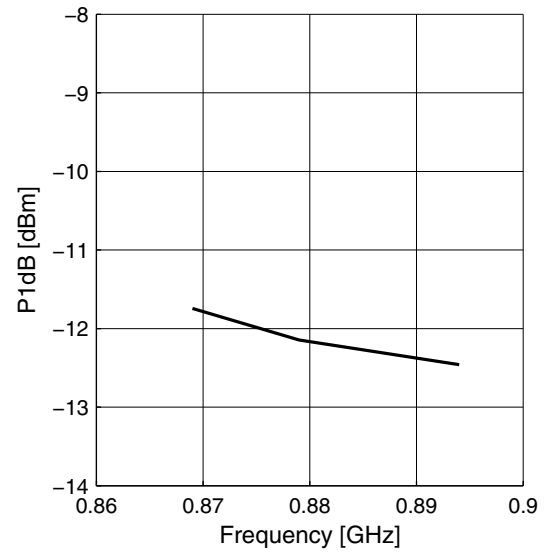

### 2.12 Measured Performance Low Band High Gain Mode vs. Temperature

$V_{CC} = 2.8\text{ V}$ ,  $V_{GS} = 2.8\text{ V}$ ,  $V_{EN1} = 0\text{ V}$ ,  $V_{EN2} = 2.8\text{ V}$

Power Gain  $|S_{21}| = f(T_A)$

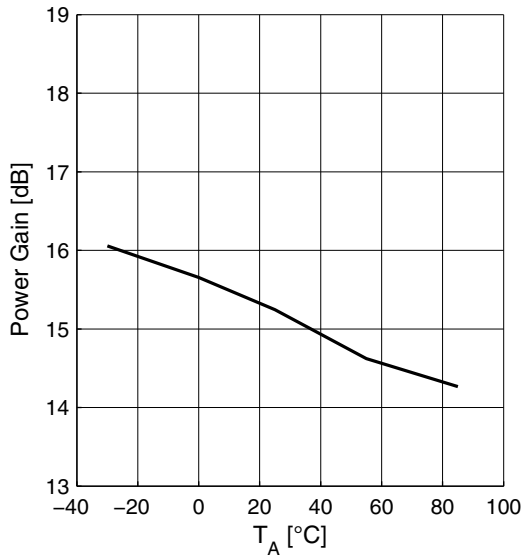

Supply Current  $I_{CC} = f(T_A)$

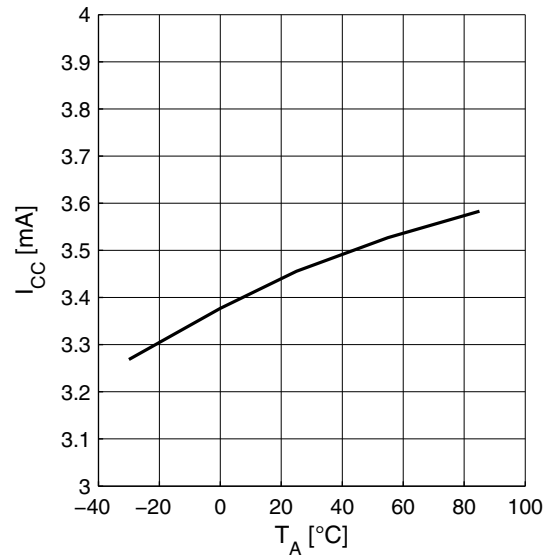

Noise Figure  $NF = f(T_A)$

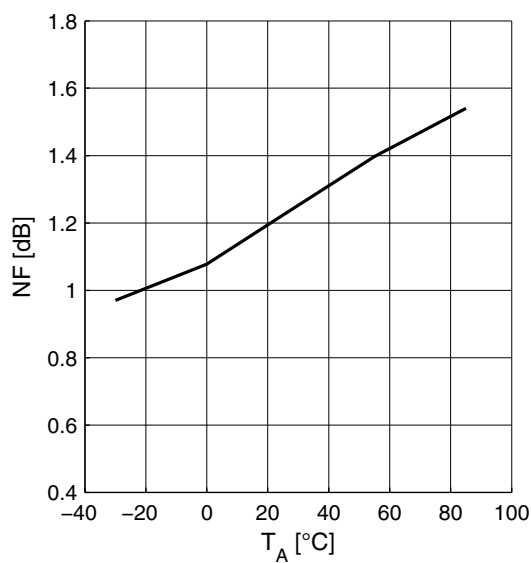

Input Compression  $P_{1dB} = f(T_A)$

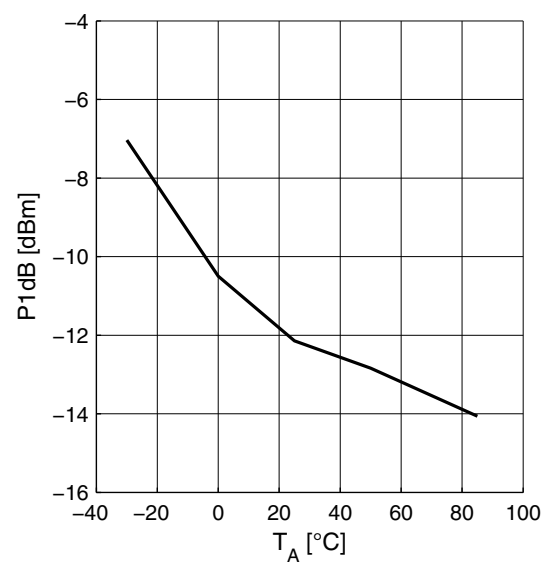

### 2.13 Measured Performance Low Band Low Gain Mode vs. Frequency

$T_A = 25\text{ }^\circ\text{C}$ ,  $V_{CC} = 2.8\text{ V}$ ,  $V_{GS} = 0\text{ V}$ ,  $V_{EN1} = 0\text{ V}$ ,  $V_{EN2} = 2.8\text{ V}$

Power Gain  $|S_{21}| = f(f)$

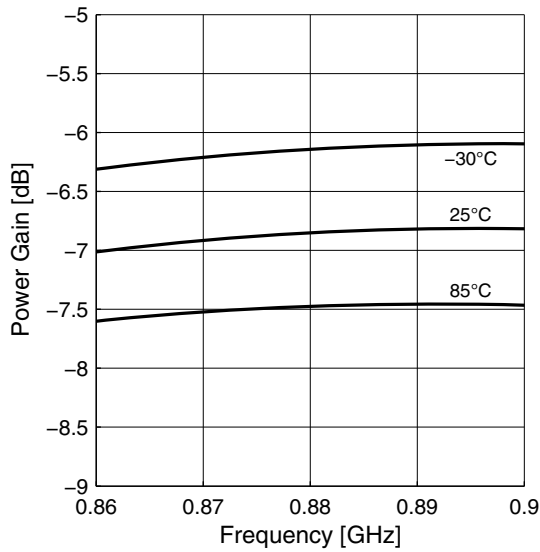

Power Gain Wideband  $|S_{21}| = f(f)$

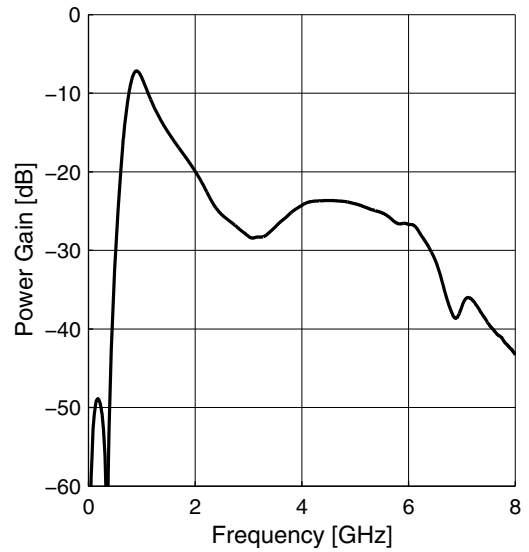

Matching  $|S_{11}| = f(f)$ ,  $|S_{22}| = f(f)$

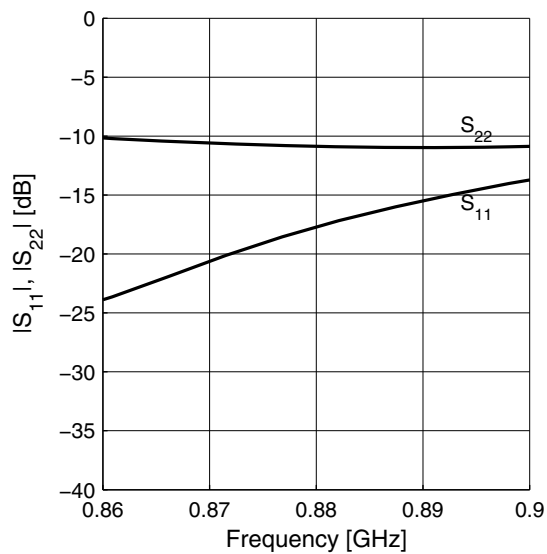

Noise Figure  $NF = f(f)$

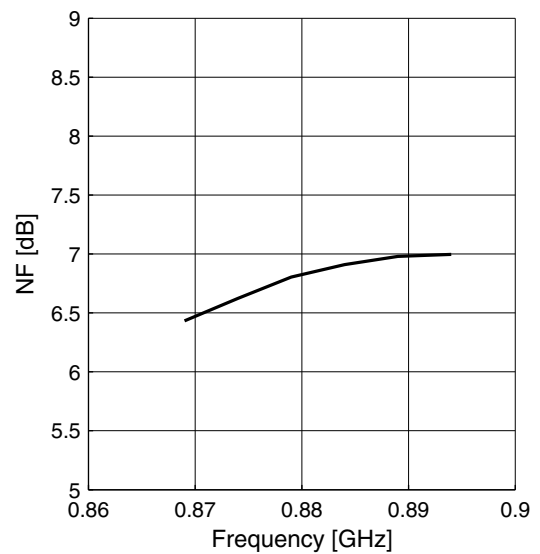

Input Compression  $P_{1dB} = f(f)$

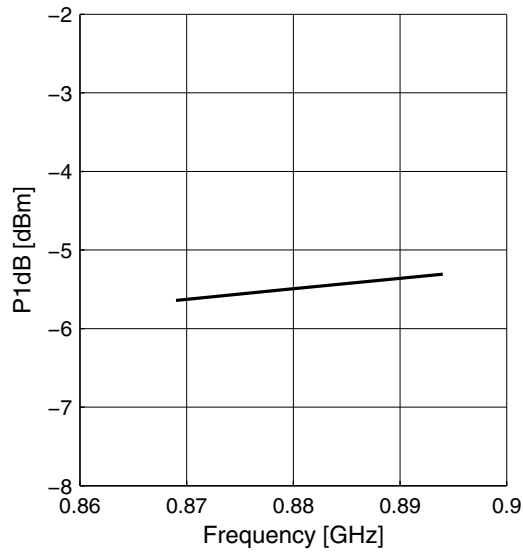



## 2.14 Measured Performance Low Band Low Gain Mode vs. Temperature

$V_{CC} = 2.8 \text{ V}$ ,  $V_{GS} = 0 \text{ V}$ ,  $V_{EN1} = 0 \text{ V}$ ,  $V_{EN2} = 2.8 \text{ V}$

Power Gain  $|S_{21}| = f(T_A)$

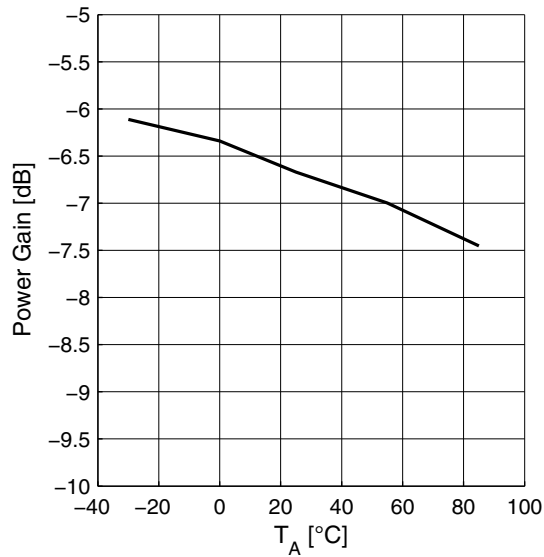

Supply Current  $I_{CC} = f(T_A)$

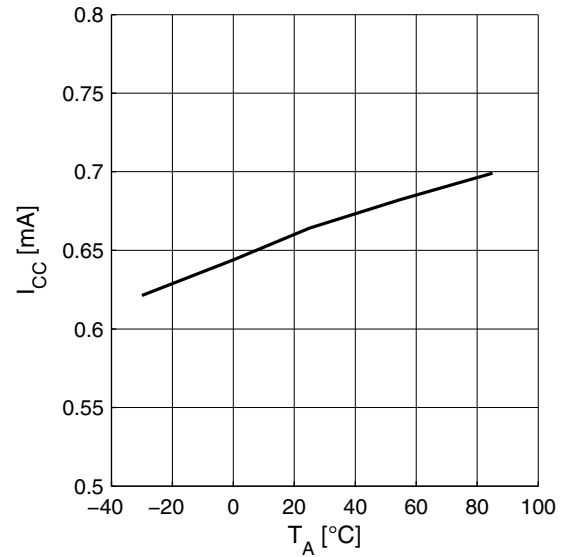

Noise Figure  $NF = f(T_A)$

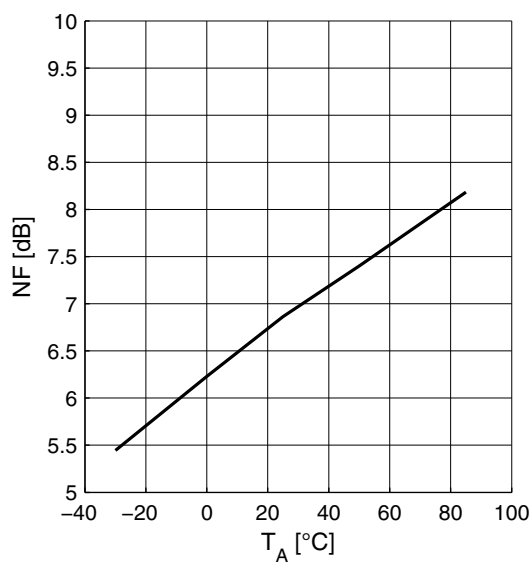

Input Compression  $P_{1dB} = f(T_A)$

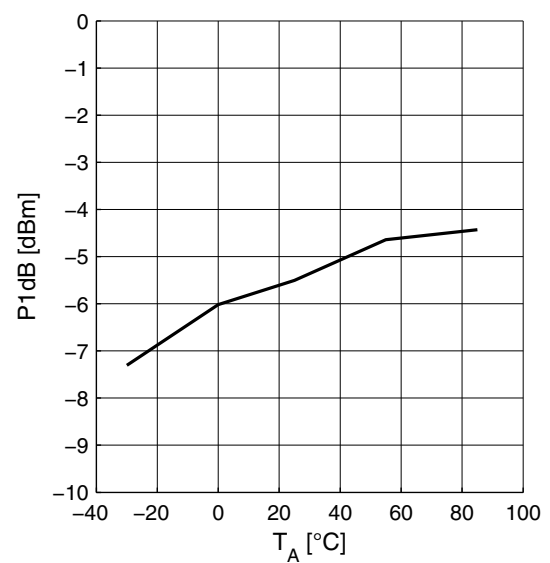

### 2.15 Measured Performance Mid Band High Gain Mode vs. Frequency

$T_A = 25\text{ }^\circ\text{C}$ ,  $V_{CC} = 2.8\text{ V}$ ,  $V_{GS} = 2.8\text{ V}$ ,  $V_{EN1} = 2.8\text{ V}$ ,  $V_{EN2} = 0\text{ V}$

Power Gain  $|S_{21}| = f(f)$

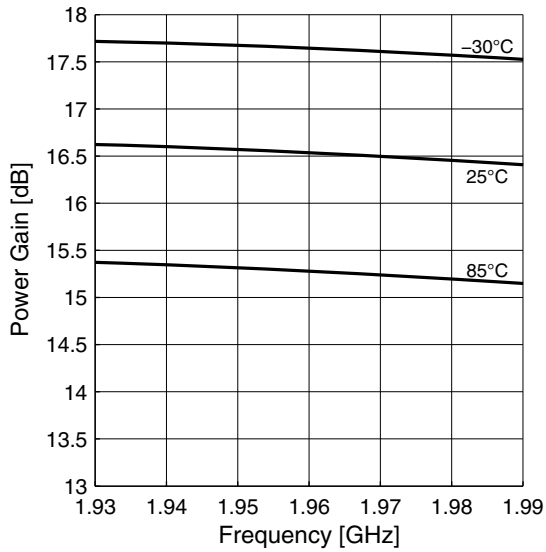

Power Gain Wideband  $|S_{21}| = f(f)$

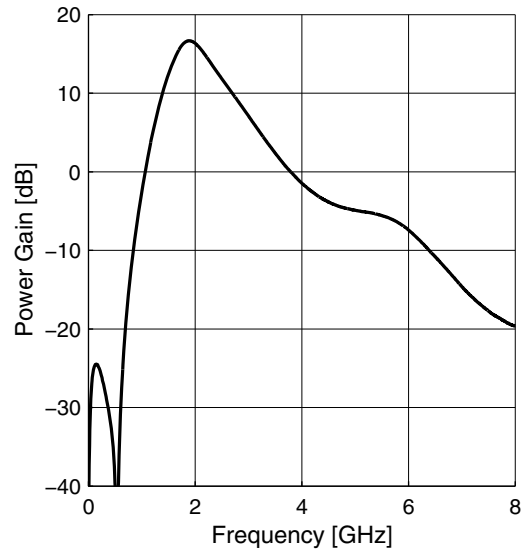

Matching  $|S_{11}| = f(f)$ ,  $|S_{22}| = f(f)$

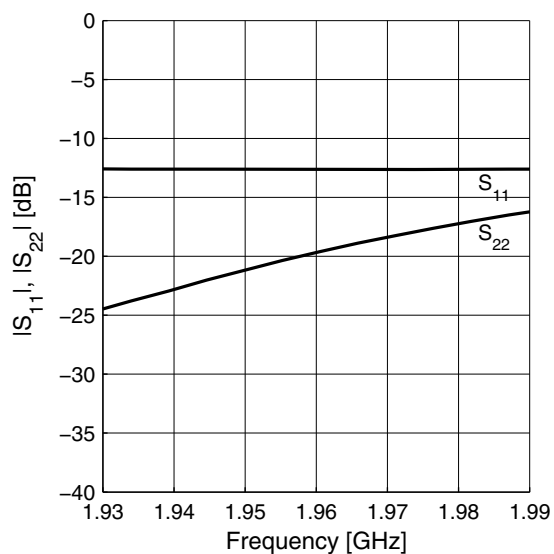

Gainstep HG - LG  $|\Delta S_{21}| = f(f)$

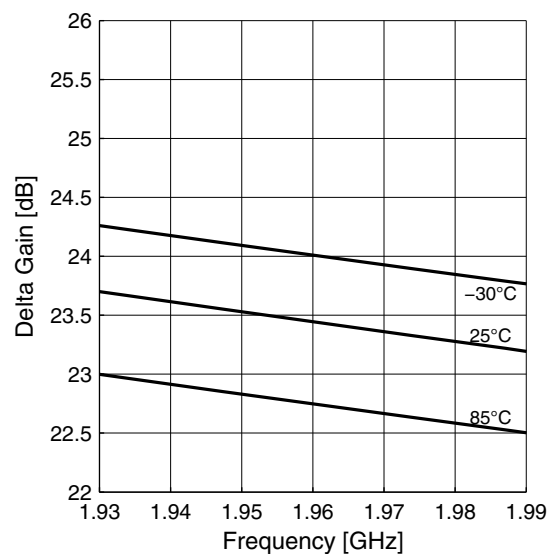

**Noise Figure  $NF = f(f)$**

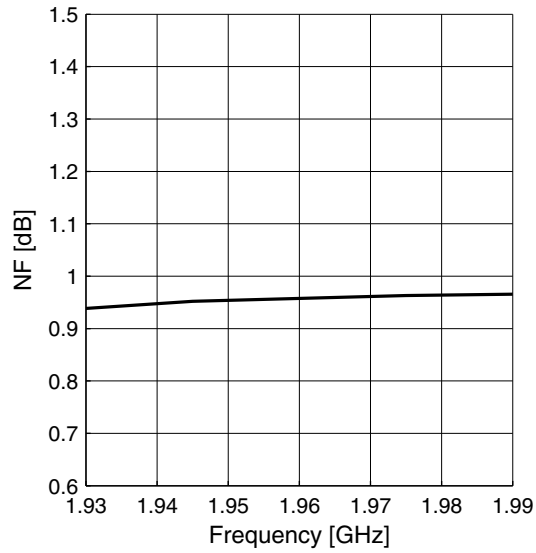

**Input Compression  $P_{1dB} = f(f)$**

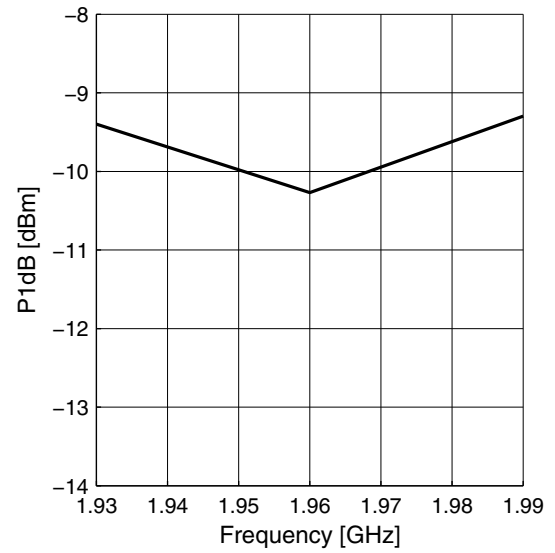

### 2.16 Measured Performance Mid Band High Gain Mode vs. Temperature

$V_{CC} = 2.8\text{ V}$ ,  $V_{GS} = 2.8\text{ V}$ ,  $V_{EN1} = 2.8\text{ V}$ ,  $V_{EN2} = 0\text{ V}$

Power Gain  $|S_{21}| = f(T_A)$

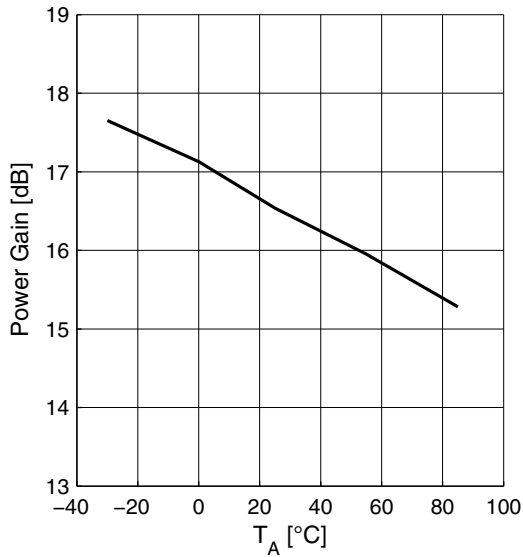

Supply Current  $I_{CC} = f(T_A)$

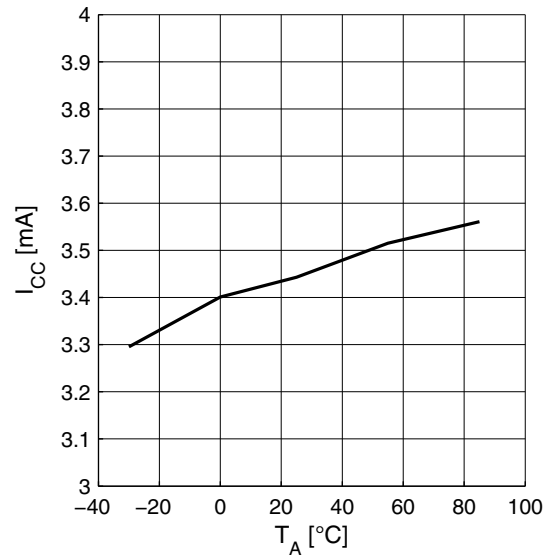

Noise Figure  $NF = f(T_A)$

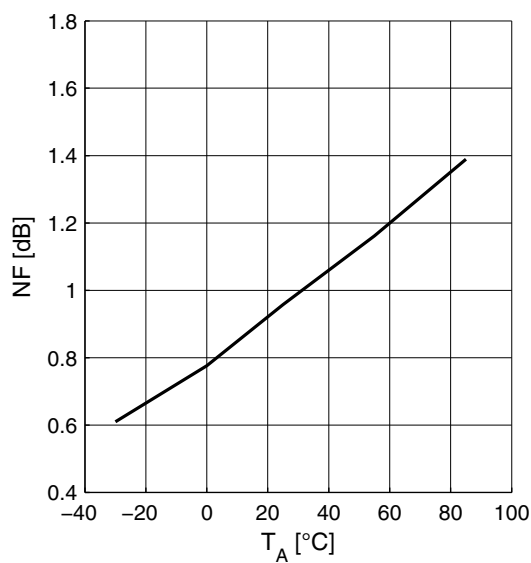

Input Compression  $P_{1dB} = f(T_A)$

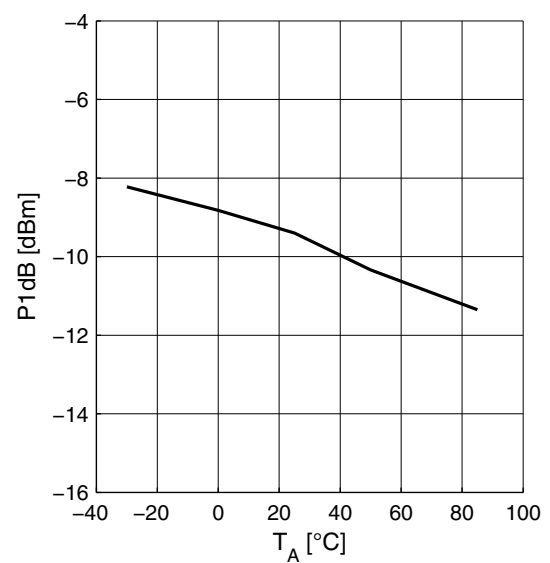

### 2.17 Measured Performance Mid Band Low Gain Mode vs. Frequency

$T_A = 25\text{ }^\circ\text{C}$ ,  $V_{CC} = 2.8\text{ V}$ ,  $V_{GS} = 0\text{ V}$ ,  $V_{EN1} = 2.8\text{ V}$ ,  $V_{EN2} = 0\text{ V}$

Power Gain  $|S_{21}| = f(f)$

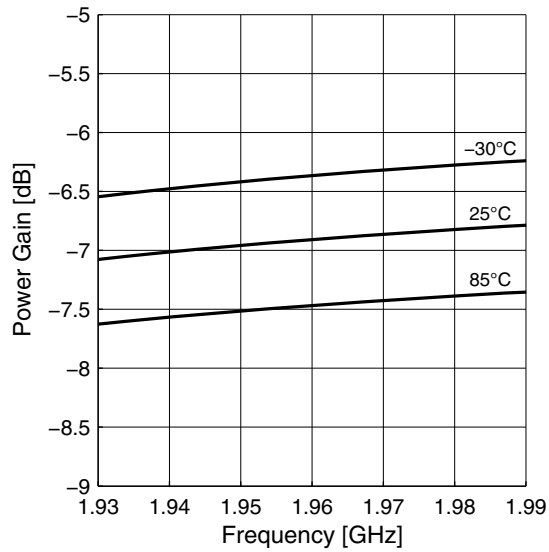

Power Gain Wideband  $|S_{21}| = f(f)$

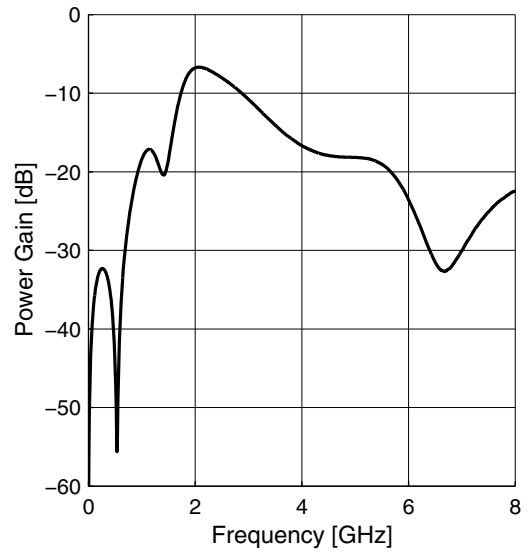

Matching  $|S_{11}| = f(f)$ ,  $|S_{22}| = f(f)$

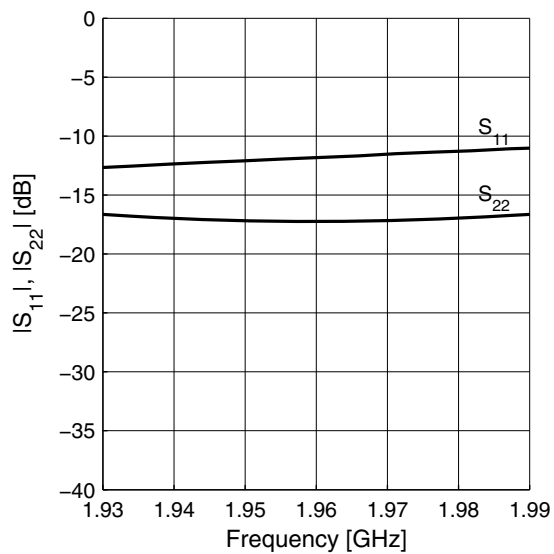

Noise Figure  $NF = f(f)$

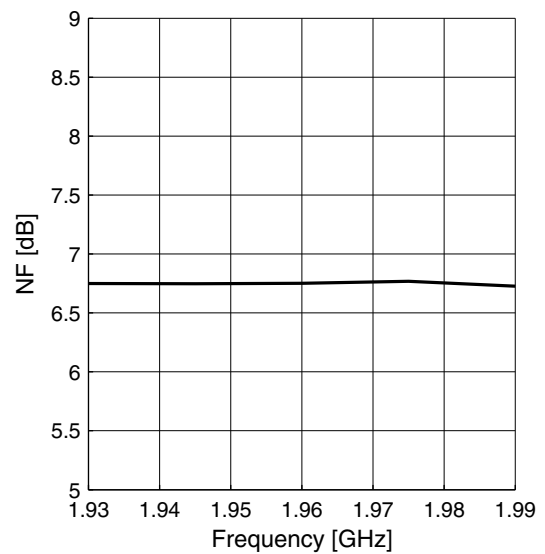

Input Compression  $P_{1dB} = f(f)$

