



Chipsmall Limited consists of a professional team with an average of over 10 year of expertise in the distribution of electronic components. Based in Hongkong, we have already established firm and mutual-benefit business relationships with customers from,Europe,America and south Asia,supplying obsolete and hard-to-find components to meet their specific needs.

With the principle of “Quality Parts,Customers Priority,Honest Operation,and Considerate Service”,our business mainly focus on the distribution of electronic components. Line cards we deal with include Microchip,ALPS,ROHM,Xilinx,Pulse,ON,Everlight and Freescale. Main products comprise IC,Modules,Potentiometer,IC Socket,Relay,Connector.Our parts cover such applications as commercial,industrial, and automotives areas.

We are looking forward to setting up business relationship with you and hope to provide you with the best service and solution. Let us make a better world for our industry!



Contact us

Tel: +86-755-8981 8866 Fax: +86-755-8427 6832

Email & Skype: info@chipsmall.com Web: www.chipsmall.com

Address: A1208, Overseas Decoration Building, #122 Zhenhua RD., Futian, Shenzhen, China



BGA771L16

High Linearity Dual-Band UMTS LNA
(1900/1800/2100, 800/900 MHz)

Small Signal Discretes



Never stop thinking

Edition 2008-08-26

**Published by
Infineon Technologies AG
81726 München, Germany**

**© Infineon Technologies AG 2008.
All Rights Reserved.**

Legal Disclaimer

The information given in this document shall in no event be regarded as a guarantee of conditions or characteristics ("Beschaffenhheitsgarantie"). With respect to any examples or hints given herein, any typical values stated herein and/or any information regarding the application of the device, Infineon Technologies hereby disclaims any and all warranties and liabilities of any kind, including without limitation warranties of non-infringement of intellectual property rights of any third party.

Information

For further information on technology, delivery terms and conditions and prices please contact your nearest Infineon Technologies Office (www.infineon.com).

Warnings

Due to technical requirements components may contain dangerous substances. For information on the types in question please contact your nearest Infineon Technologies Office.

Infineon Technologies Components may only be used in life-support devices or systems with the express written approval of Infineon Technologies, if a failure of such components can reasonably be expected to cause the failure of that life-support device or system, or to affect the safety or effectiveness of that device or system. Life support devices or systems are intended to be implanted in the human body, or to support and/or maintain and sustain and/or protect human life. If they fail, it is reasonable to assume that the health of the user or other persons may be endangered.



BGA771L16

Revision History: 2008-08-26, V3.0

Previous Version: 2008-07-17, V2.1 preliminary

Page	Subjects (major changes since last revision)
6	Updated value for thermal resistance
8	Added supply current characteristics

Table of Contents

	Table of Contents	4
1	Description	5
2	Electrical Characteristics	6
2.1	Absolute Maximum Ratings	6
2.2	Thermal Resistance	6
2.3	ESD Integrity	6
2.4	DC Characteristics	7
2.5	Band Select / Gain Control Truth Table	7
2.6	Supply current characteristics; $T_A = 25\text{ }^\circ\text{C}$	8
2.7	Logic Signal Characteristics; $T_A = 25\text{ }^\circ\text{C}$	9
2.8	Switching Times	9
2.9	Measured RF Characteristics Low Band	10
2.9.1	Measured RF Characteristics UMTS Bands V / VI	10
2.9.2	Measured RF Characteristics UMTS Band VIII	11
2.10	Measured RF Characteristics Mid Band	12
2.10.1	Measured RF Characteristics UMTS Band II	12
2.10.2	Measured RF Characteristics UMTS Bands III / IX	13
2.10.3	Measured RF Characteristics UMTS Band IV	14
2.11	Measured Performance Low Band (Band V) High Gain Mode vs. Frequency	15
2.12	Measured Performance Low Band (Band V) High Gain Mode vs. Temperature	16
2.13	Measured Performance Low Band (Band V) Low Gain Mode vs. Frequency	17
2.14	Measured Performance Low Band (Band V) Low Gain Mode vs. Temperature	19
2.15	Measured Performance Mid Band (Band II) High Gain Mode vs. Frequency	20
2.16	Measured Performance Mid Band (Band II) High Gain Mode vs. Temperature	21
2.17	Measured Performance Mid Band (Band II) Low Gain Mode vs. Frequency	22
2.18	Measured Performance Mid Band (Band II) Low Gain Mode vs. Temperature	24
3	Application Circuit and Block Diagram	25
3.1	UMTS bands II and V Application Circuit Schematic	25
3.2	UMTS bands III and VIII Application Circuit Schematic	26
3.3	UMTS bands IV and VIII Application Circuit Schematic	27
3.4	Pin Definition	28
3.5	Application Board	29
4	Physical Characteristics	31
4.1	Package Footprint	31
4.2	Package Dimensions	32

1 Description

The BGA771L16 is a highly flexible, high linearity dual-band (1900/1800/2100, 800/900 MHz) low noise amplifier MMIC for worldwide use. Based on Infineon's proprietary and cost-effective SiGe:C technology, the BGA771L16 uses an advanced biasing concept in order to achieve high linearity.

The device features dynamic gain control, temperature stabilization, standby mode, and 2 kV ESD protection on-chip as well as matching off chip. Because the matching is off chip, different UMTS bands can be easily applied. For example, the 1900 MHz path can be converted into a 1800 MHz or a 2100 MHz path by optimizing the input and output matching network.

Note: UMTS bands II / V is the standard band combination for this product requiring no external output matching network.

Features

- Gain: 16 / -7.5 dB in high / low gain mode (all bands)
- Noise figure: 1.1 / 1.1 dB in high gain mode (800 MHz / 1900 MHz)
- Supply current: 3.4 / 0.65 mA in high / low gain mode (all bands)
- Standby mode (< 2 μ A typ.)
- Output internally matched to 50 Ω
- Inputs pre-matched to 50 Ω
- 2kV HBM ESD protection
- Low external component count
- Small leadless TSLP-16-1 package (2.3 x 2.3 x 0.39 mm)
- Pb-free (RoHS compliant) package

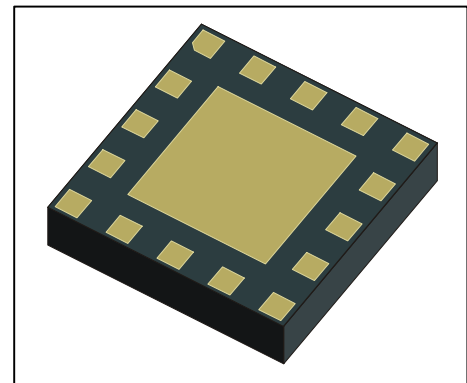

TSLP-16-1 package

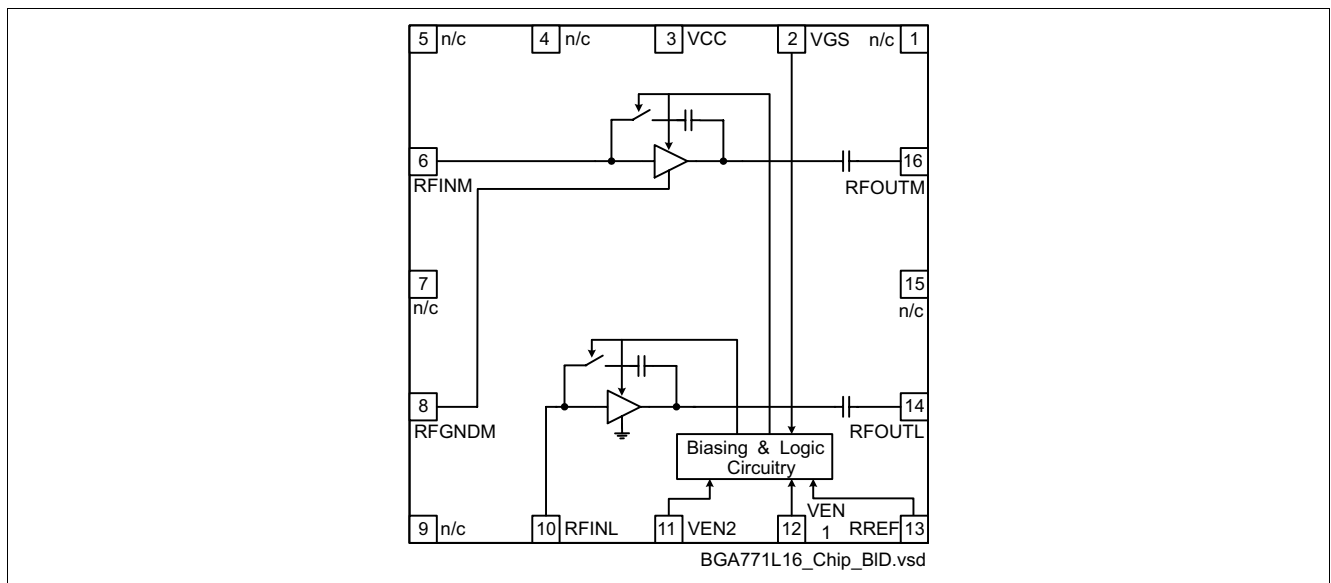

Figure 1 Block diagram of dual-band LNA

Type	Package	Marking	Chip
BGA771L16	TSLP-16-1	BGA771	T1530

2 Electrical Characteristics

2.1 Absolute Maximum Ratings

Table 1 Absolute Maximum Ratings

Parameter	Symbol	Values		Unit	Note / Test Condition
		Min.	Max.		
Supply voltage	V_{CC}	-0.3	3.6	V	
Supply current	I_{CC}		10	mA	
Pin voltage	V_{PIN}	-0.3	$V_{CC}+0.3$	V	All pins except RF input pins
Pin voltage RF Input Pins	V_{RFIN}	-0.3	0.9	V	
RF input power	P_{RFIN}		4	dBm	
Junction temperature	T_j		150	°C	
Ambient temperature range	T_A	-30	85	°C	
Storage temperature range	T_{stg}	-65	150	°C	

2.2 Thermal Resistance

Table 2 Thermal Resistance

Parameter	Symbol	Value	Unit	Note / Test Conditions
Thermal resistance junction to soldering point	R_{thJS}	≤ 37	K/W	

2.3 ESD Integrity

Table 3 ESD Integrity

Parameter	Symbol	Value (typ.)	Unit	Note / Test Conditions
ESD hardness HBM ¹⁾	$V_{ESD-HBM}$	2000	V	All pins

1) According to JESD22-A114

2.4 DC Characteristics

Table 4 DC Characteristics, $T_A = 25\text{ }^\circ\text{C}$

Parameter	Symbol	Values			Unit	Note / Test Condition
		Min.	Typ.	Max.		
Supply voltage	V_{CC}	2.7	2.8	3.0	V	
Supply current high gain mode	I_{CCHG}		3.4		mA	All bands
Supply current low gain mode	I_{CCLG}		650		μA	All bands
Supply current standby mode	I_{CCOFF}		0.1	2	μA	
Logic level high	V_{HI}	1.5	2.8		V	VEN1, VEN2 and VGS
Logic level low	V_{LO}		0.0	0.5	V	
Logic currents VEN	I_{ENL}		0.2		μA	VEN1 and VEN2
	I_{ENH}		10.0		μA	
Logic currents VGS	I_{GSL}		0.1		μA	VGS
	I_{GSH}		5.0		μA	

2.5 Band Select / Gain Control Truth Table

Table 5 Band Select Truth Table, $V_{CC} = 2.8\text{ V}$

	Mid band	Low band	Power Down
VEN1	H	L	L
VEN2	L	H	L

Table 6 Gain Control Truth Table, $V_{CC} = 2.8\text{ V}$

	High Gain	Low Gain
VGS	H	L

2.6 Supply current characteristics; $T_A = 25\text{ }^\circ\text{C}$

Supply current high / mid gain mode versus reference resistor R_{REF} (see [Figure 2 on page 25](#) for reference resistor; low gain mode supply current is independent of reference resistor).

Supply Current Midband $I_{CC} = f(R_{REF})$
 $V_{CC} = 2.8\text{ V}$

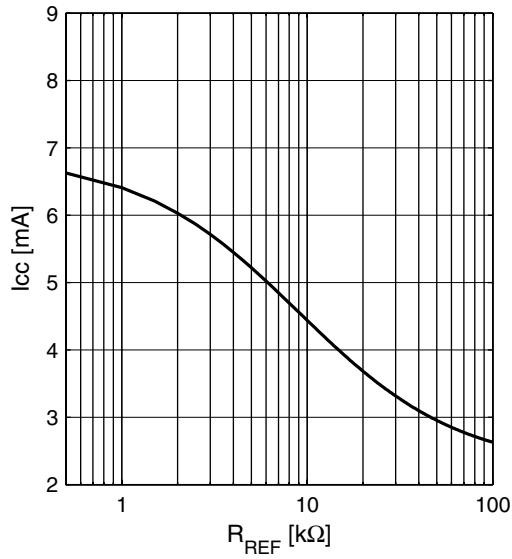

Supply Current Lowband $I_{CC} = f(R_{REF})$
 $V_{CC} = 2.8\text{ V}$

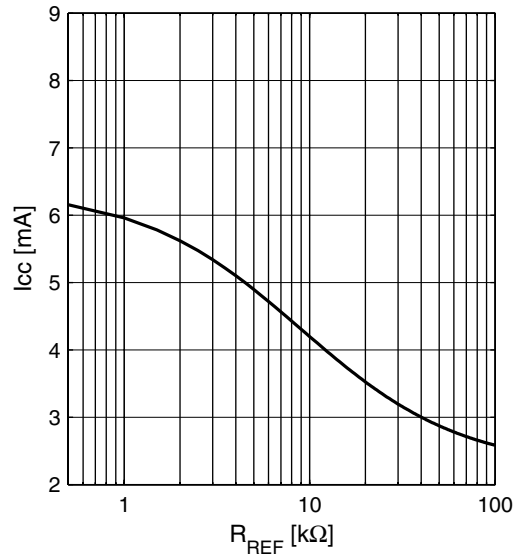

2.7 Logic Signal Characteristics; $T_A = 25\text{ °C}$

Current consumption of logic inputs VEN1, VEN2, VGS

Logic currents $I_{EN1,2} = f(V_{EN1,2})$
 $V_{CC} = 2.8\text{ V}$

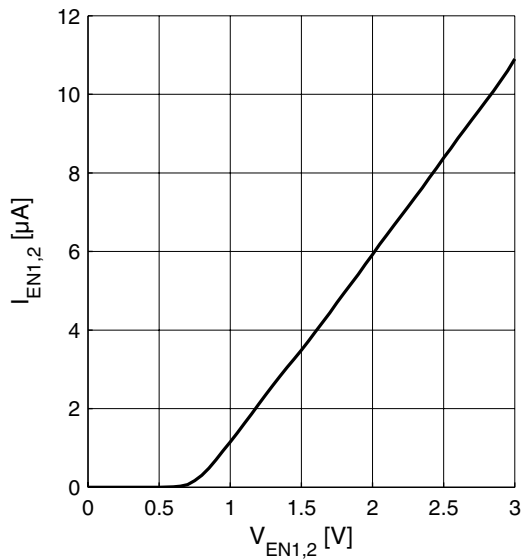

Logic currents $I_{GS} = f(V_{GS})$
 $V_{CC} = 2.8\text{ V}$

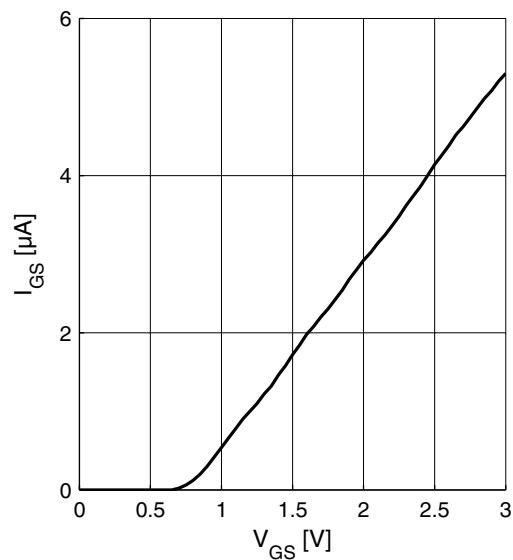

2.8 Switching Times

Table 7 Typical switching times; $T_A = -30 \dots 85\text{ °C}$

Parameter	Symbol	Values			Unit	Note / Test Condition
		Min.	Typ.	Max.		
Settling time gainstep	t_{GS}		1		µs	Switching LG ↔ HG all bands
Settling time bandselect	t_{BS}		1		µs	Switching from any band to a different band

2.9 Measured RF Characteristics Low Band

2.9.1 Measured RF Characteristics UMTS Bands V / VI

Table 8 Typical Characteristics 800 MHz Band, $T_A = 25\text{ °C}$, $V_{CC} = 2.8\text{ V}$

Parameter	Symbol	Values			Unit	Note / Test Condition
		Min.	Typ.	Max.		
Pass band range band V		869		894	MHz	
Pass band range band VI		875		885	MHz	
Current consumption	I_{CCHG}		3.4		mA	High gain mode
	I_{CCLG}		0.65		mA	Low gain mode
Gain	S_{21HG}		16.1		dB	High gain mode
	S_{21LG}		-7.5		dB	Low gain mode
Reverse Isolation ¹⁾	S_{12HG}		-36		dB	High gain mode
	S_{12LG}		-8		dB	Low gain mode
Noise figure	NF_{HG}		1.1		dB	High gain mode
	NF_{LG}		7.5		dB	Low gain mode
Input return loss ¹⁾	S_{11HG}		-17		dB	50 Ω , high gain mode
	S_{11LG}		-17		dB	50 Ω , low gain mode
Output return loss ¹⁾	S_{22HG}		-17		dB	50 Ω , high gain mode
	S_{22LG}		-13		dB	50 Ω , low gain mode
Stability factor ²⁾	k		>2.3			DC to 10 GHz; all gain modes
Input compression point ¹⁾	IP_{1dBHG}		-6		dBm	High gain mode
	$IP_{1dB LG}$		-8		dBm	Low gain mode
Inband IIP3 ¹⁾ $f_1 - f_2 = 1\text{ MHz}$ $P_{f1} = P_{f2} = -37\text{ dBm}$	$IIP3_{HG}$		-7		dBm	High gain mode
	$IIP3_{LG}$		2			Low gain mode

1) Verified by random sampling; not 100% RF tested

2) Not tested in production; guaranteed by device design

2.9.2 Measured RF Characteristics UMTS Band VIII

Table 9 Typical Characteristics 900 MHz Band, $T_A = 25\text{ °C}$, $V_{CC} = 2.8\text{ V}$

Parameter	Symbol	Values			Unit	Note / Test Condition
		Min.	Typ.	Max.		
Pass band range		925		960	MHz	
Current consumption	I_{CCHG}		3.4		mA	High gain mode
	I_{CCLG}		0.65		mA	Low gain mode
Gain	S_{21HG}		16.1		dB	High gain mode
	S_{21LG}		-7.1		dB	Low gain mode
Reverse Isolation ¹⁾	S_{12HG}		-36		dB	High gain mode
	S_{12LG}		-7		dB	Low gain mode
Noise figure	NF_{HG}		1.1		dB	High gain mode
	NF_{LG}		7.1		dB	Low gain mode
Input return loss ¹⁾	S_{11HG}		-16		dB	50 Ω , high gain mode
	S_{11LG}		-15		dB	50 Ω , low gain mode
Output return loss ¹⁾	S_{22HG}		-15		dB	50 Ω , high gain mode
	S_{22LG}		-16		dB	50 Ω , low gain mode
Stability factor ²⁾	k		>2.3			DC to 10 GHz; all gain modes
Input compression point ¹⁾	IP_{1dBHG}		-5		dBm	High gain mode
	$IP_{1dB LG}$		-8		dBm	Low gain mode
Inband IIP3 ¹⁾ $f_1 - f_2 = 1\text{ MHz}$ $P_{f1} = P_{f2} = -37\text{ dBm}$	$IIP3_{HG}$		-6		dBm	High gain mode
	$IIP3_{LG}$		2			Low gain mode

1) Verified by random sampling; not 100% RF tested

2) Not tested in production; guaranteed by device design

2.10 Measured RF Characteristics Mid Band

2.10.1 Measured RF Characteristics UMTS Band II

Table 10 Typical Characteristics 1900 MHz Band, $T_A = 25\text{ °C}$, $V_{CC} = 2.8\text{ V}$

Parameter	Symbol	Values			Unit	Note / Test Condition
		Min.	Typ.	Max.		
Pass band range		1930		1990	MHz	
Current consumption	I_{CCHG}		3.4		mA	High gain mode
	I_{CCLG}		0.65		mA	Low gain mode
Gain	S_{21HG}		16.0		dB	High gain mode
	S_{21LG}		-7.8		dB	Low gain mode
Reverse Isolation ¹⁾	S_{12HG}		-35		dB	High gain mode
	S_{12LG}		-8		dB	Low gain mode
Noise figure	NF_{HG}		1.1		dB	High gain mode
	NF_{LG}		7.8		dB	Low gain mode
Input return loss ¹⁾	S_{11HG}		-19		dB	50 Ω , high gain mode
	S_{11LG}		-18		dB	50 Ω , low gain mode
Output return loss ¹⁾	S_{22HG}		-20		dB	50 Ω , high gain mode
	S_{22LG}		-15		dB	50 Ω , low gain mode
Stability factor ²⁾	k		>2.4			DC to 10 GHz; all gain modes
Input compression point ¹⁾	IP_{1dBHG}		-7		dBm	High gain mode
	$IP_{1dB LG}$		-7		dBm	Low gain mode
Inband IIP3 ¹⁾ $f_1 - f_2 = 1\text{ MHz}$ $P_{f1} = P_{f2} = -37\text{ dBm}$	$IIP3_{HG}$		-6		dBm	High gain mode
	$IIP3_{LG}$		3			Low gain mode

1) Verified by random sampling; not 100% RF tested

2) Not tested in production; guaranteed by device design

2.10.2 Measured RF Characteristics UMTS Bands III / IX

Table 11 Typical Characteristics 1800 MHz Band, $T_A = 25\text{ °C}$, $V_{CC} = 2.8\text{ V}$

Parameter	Symbol	Values			Unit	Note / Test Condition
		Min.	Typ.	Max.		
Pass band range band III		1805		1880	MHz	
Pass band range band IX		1844.9		1879.9	MHz	
Current consumption	I_{CCHG}		3.4		mA	High gain mode
	I_{CCLG}		0.65		mA	Low gain mode
Gain	S_{21HG}		16.2		dB	High gain mode
	S_{21LG}		-8.7		dB	Low gain mode
Reverse Isolation ¹⁾	S_{12HG}		-36		dB	High gain mode
	S_{12LG}		-9		dB	Low gain mode
Noise figure	NF_{HG}		1.0		dB	High gain mode
	NF_{LG}		8.7		dB	Low gain mode
Input return loss ¹⁾	S_{11HG}		-13		dB	50 Ω , high gain mode
	S_{11LG}		-14		dB	50 Ω , low gain mode
Output return loss ¹⁾	S_{22HG}		-19		dB	50 Ω , high gain mode
	S_{22LG}		-15		dB	50 Ω , low gain mode
Stability factor ²⁾	k		>2.5			DC to 10 GHz; all gain modes
Input compression point ¹⁾	IP_{1dBHG}		-7		dBm	High gain mode
	IP_{1dBLG}		-6		dBm	Low gain mode
Inband IIP3 ¹⁾ $f_1 - f_2 = 1\text{ MHz}$ $P_{f1} = P_{f2} = -37\text{ dBm}$	$IIP3_{HG}$		-5		dBm	High gain mode
	$IIP3_{LG}$		3			Low gain mode

1) Verified by random sampling; not 100% RF tested

2) Not tested in production; guaranteed by device design

2.10.3 Measured RF Characteristics UMTS Band IV

Table 12 Typical Characteristics 2100 MHz Band, $T_A = 25\text{ }^\circ\text{C}$, $V_{CC} = 2.8\text{ V}$

Parameter	Symbol	Values			Unit	Note / Test Condition
		Min.	Typ.	Max.		
Pass band range		2110		2155	MHz	
Current consumption	I_{CCHG}		3.4		mA	High gain mode
	I_{CCLG}		0.65		mA	Low gain mode
Gain	S_{21HG}		15.8		dB	High gain mode
	S_{21LG}		-7.0		dB	Low gain mode
Reverse Isolation ¹⁾	S_{12HG}		-34		dB	High gain mode
	S_{12LG}		-7		dB	Low gain mode
Noise figure	NF_{HG}		1.1		dB	High gain mode
	NF_{LG}		7		dB	Low gain mode
Input return loss ¹⁾	S_{11HG}		-19		dB	50 Ω , high gain mode
	S_{11LG}		-14		dB	50 Ω , low gain mode
Output return loss ¹⁾	S_{22HG}		-19		dB	50 Ω , high gain mode
	S_{22LG}		-15		dB	50 Ω , low gain mode
Stability factor ²⁾	k		>2.3			DC to 10 GHz; all gain modes
Input compression point ¹⁾	IP_{1dBHG}		-7		dBm	High gain mode
	$IP_{1dB LG}$		-4		dBm	Low gain mode
Inband IIP3 ¹⁾ $f_1 - f_2 = 1\text{ MHz}$ $P_{f1} = P_{f2} = -37\text{ dBm}$	$IIP3_{HG}$		-4		dBm	High gain mode
	$IIP3_{LG}$		6			Low gain mode

1) Verified by random sampling; not 100% RF tested

2) Not tested in production; guaranteed by device design

Measured Performance Low Band (Band V) High Gain Mode vs. Frequency

2.11 Measured Performance Low Band (Band V) High Gain Mode vs. Frequency

$T_A = 25^\circ\text{C}$, $V_{CC} = 2.8\text{ V}$, $V_{GS} = 2.8\text{ V}$, $V_{EN1} = 0\text{ V}$, $V_{EN2} = 2.8\text{ V}$

Power Gain $|S_{21}| = f(f)$

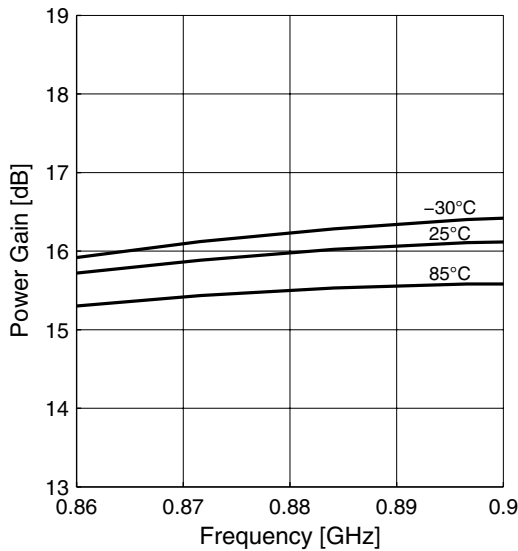

Power Gain wideband $|S_{21}| = f(f)$

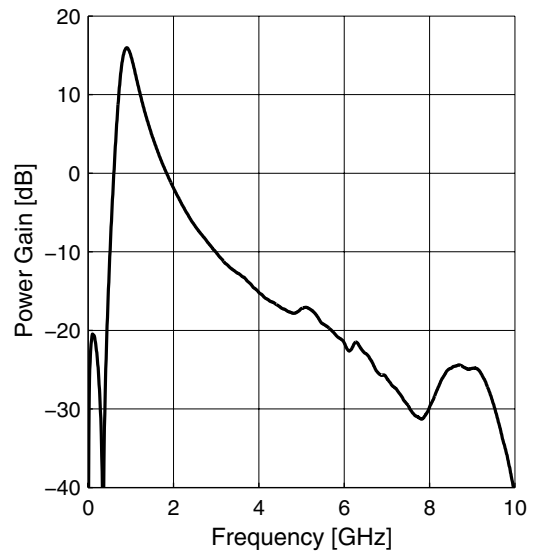

Matching $|S_{11}| = f(f)$, $|S_{22}| = f(f)$

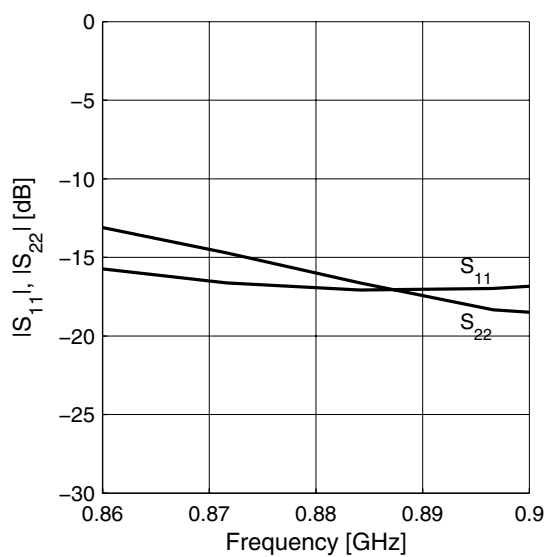

Gainstep HG-LG $|\Delta S_{21}| = f(f)$

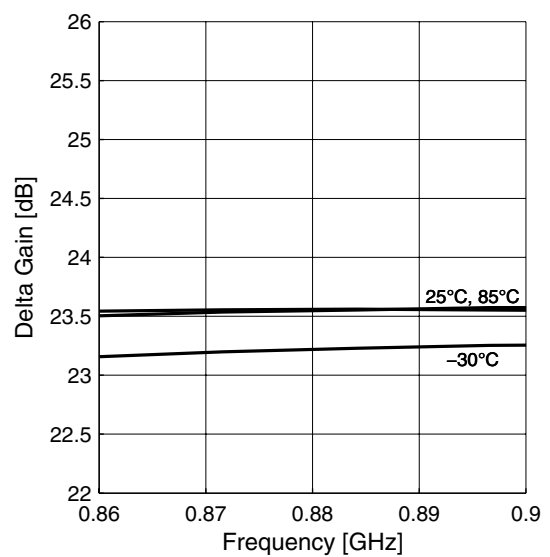

Measured Performance Low Band (Band V) High Gain Mode vs. Temperature

Noise Figure $NF = f(f)$

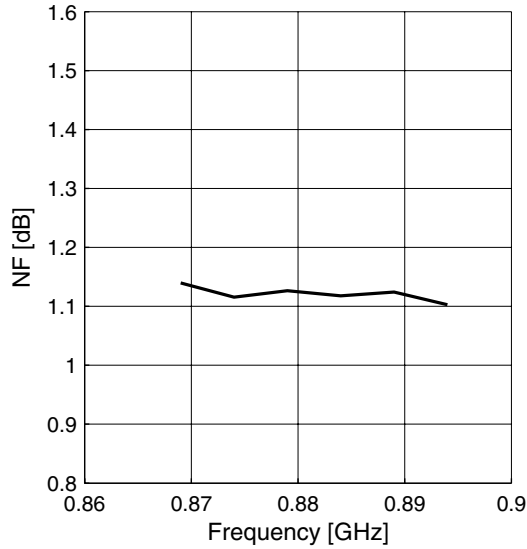

Input Compression $P1dB = f(f)$

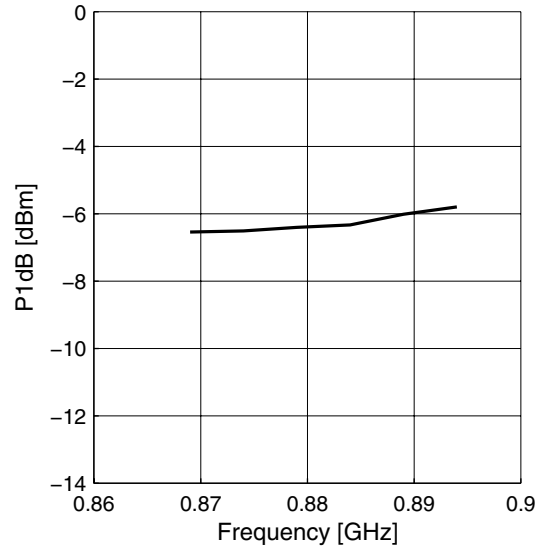

2.12 Measured Performance Low Band (Band V) High Gain Mode vs. Temperature

$V_{CC} = 2.8\text{ V}$, $V_{GS} = 2.8\text{ V}$, $V_{EN1} = 0\text{ V}$, $V_{EN2} = 2.8\text{ V}$, $f = 880\text{ MHz}$

Power Gain $|S_{21}| = f(T_A)$

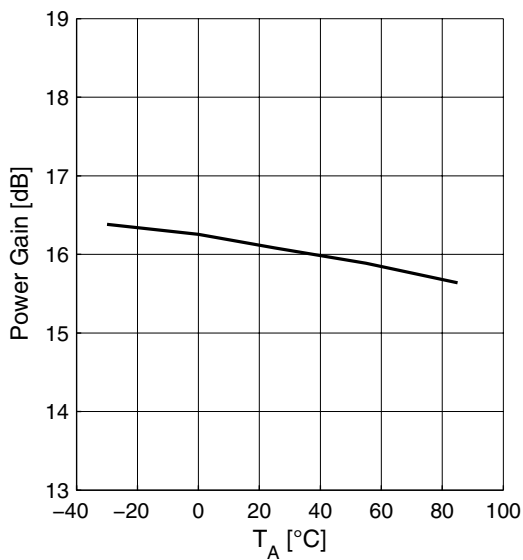

Supply Current $I_{CC} = f(T_A)$

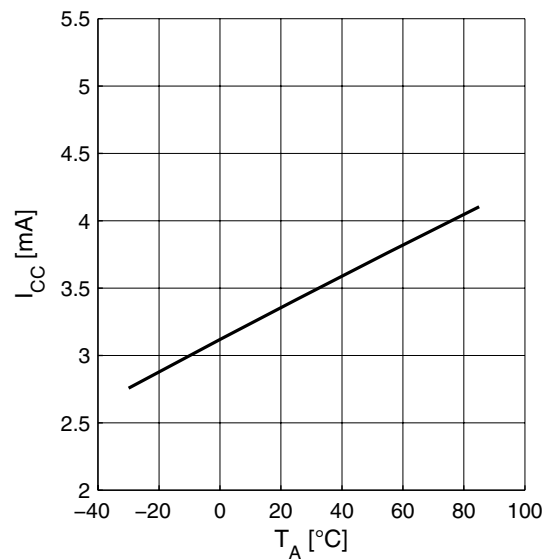

Measured Performance Low Band (Band V) Low Gain Mode vs. Frequency

Noise Figure $NF = f(T_A)$

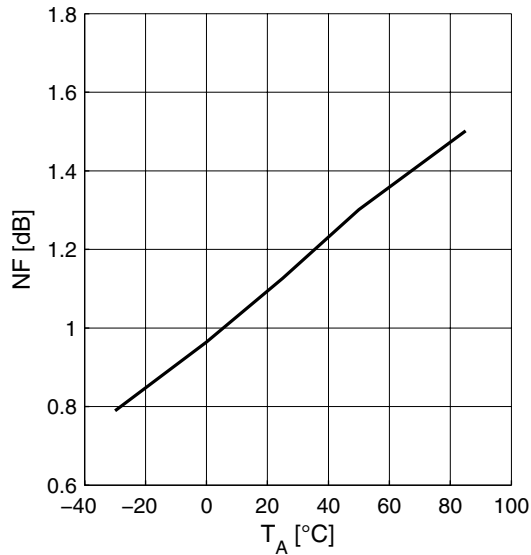

Input Compression $P1dB = f(T_A)$

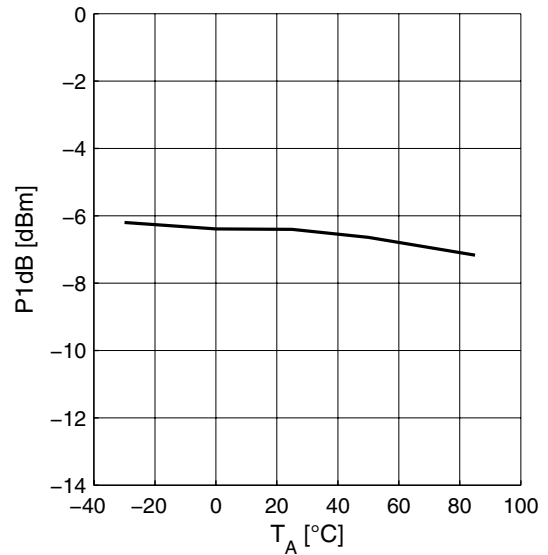

2.13 Measured Performance Low Band (Band V) Low Gain Mode vs. Frequency

$T_A = 25^\circ\text{C}$, $V_{CC} = 2.8\text{ V}$, $V_{GS} = 0\text{ V}$, $V_{EN1} = 0\text{ V}$, $V_{EN2} = 2.8\text{ V}$

Power Gain $|S_{21}| = f(f)$

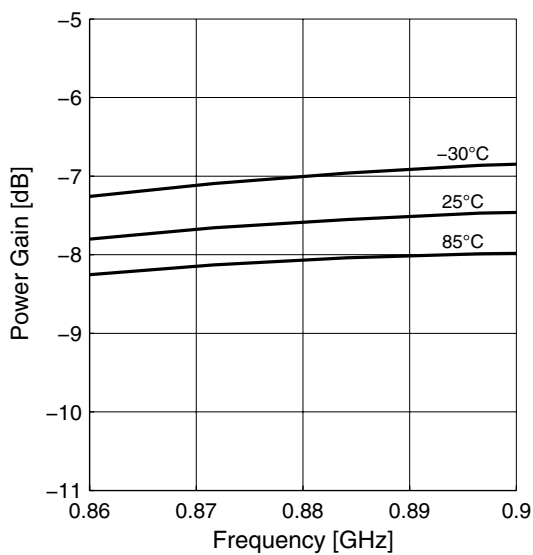

Power Gain wideband $|S_{21}| = f(f)$

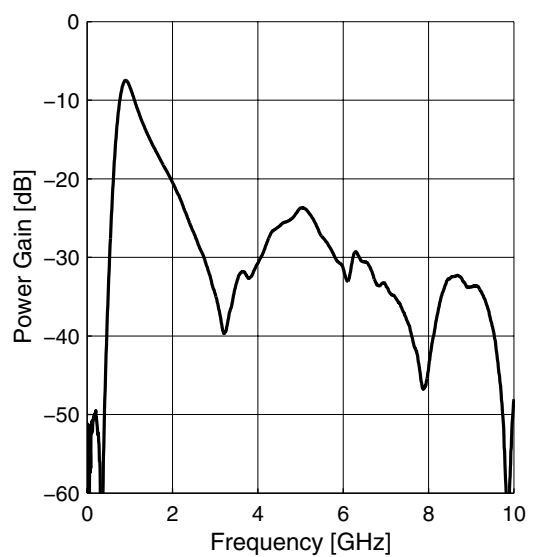

Measured Performance Low Band (Band V) Low Gain Mode vs. Frequency

Matching $|S_{11}| = f(f)$, $|S_{22}| = f(f)$

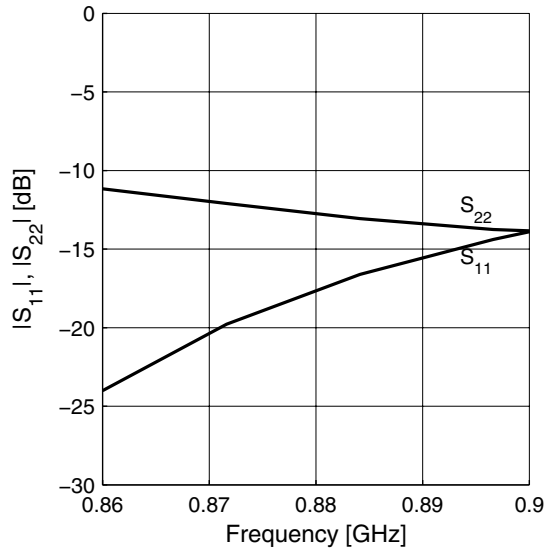

Noise Figure $NF = f(f)$

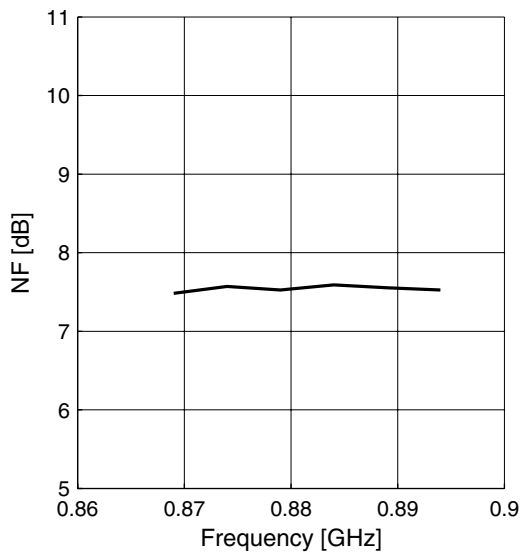

Input Compression $P1dB = f(f)$

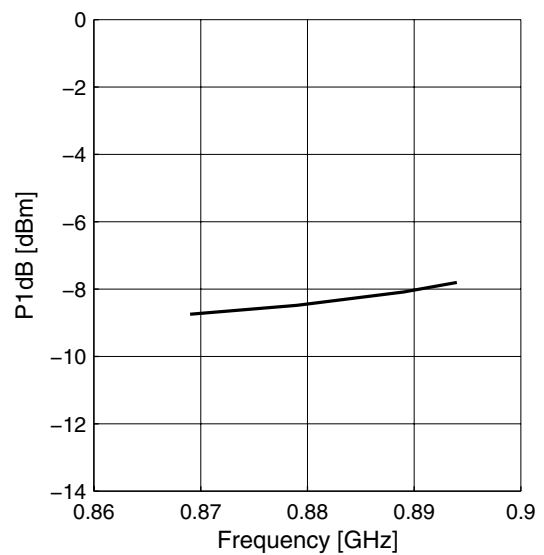

Measured Performance Low Band (Band V) Low Gain Mode vs. Temperature

2.14 Measured Performance Low Band (Band V) Low Gain Mode vs. Temperature

$V_{CC} = 2.8\text{ V}$, $V_{GS} = 0\text{ V}$, $V_{EN1} = 0\text{ V}$, $V_{EN2} = 2.8\text{ V}$, $f = 880\text{ MHz}$

Power Gain $|S_{21}| = f(T_A)$

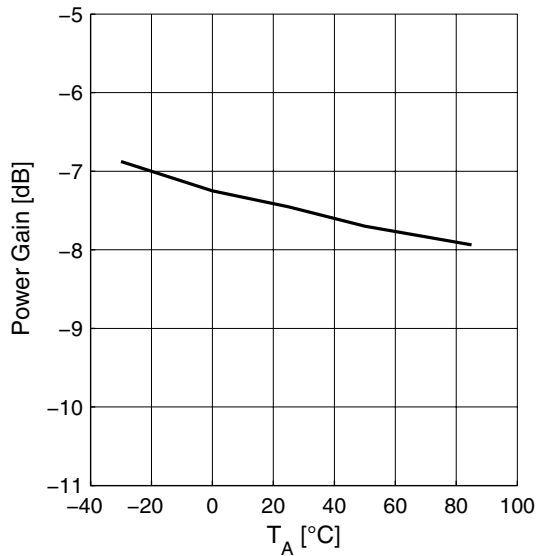

Supply Current $I_{CC} = f(T_A)$

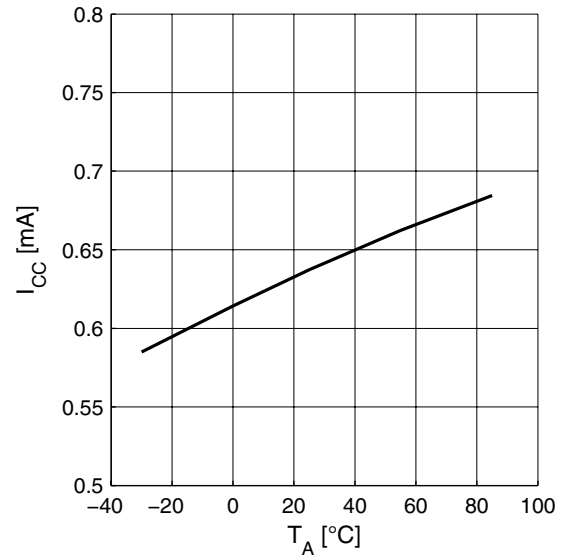

Noise Figure $NF = f(T_A)$

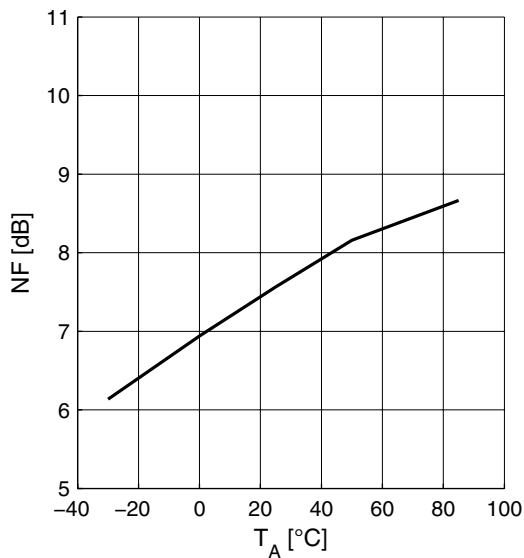

Input Compression $P1dB = f(T_A)$

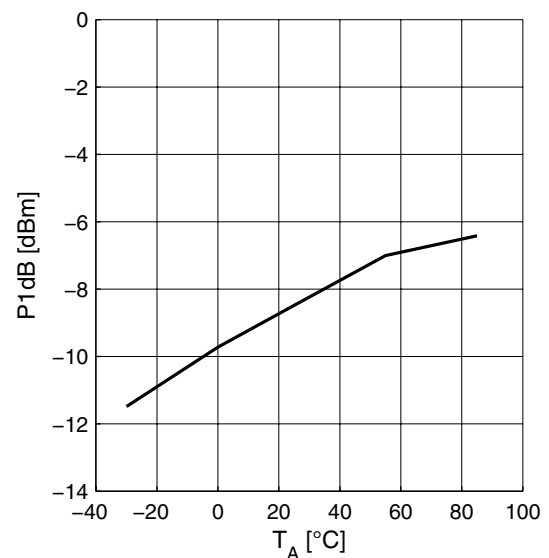

Measured Performance Mid Band (Band II) High Gain Mode vs. Frequency

2.15 Measured Performance Mid Band (Band II) High Gain Mode vs. Frequency

$T_A = 25^\circ\text{C}$, $V_{CC} = 2.8\text{ V}$, $V_{GS} = 2.8\text{ V}$, $V_{EN1} = 2.8\text{ V}$, $V_{EN2} = 0\text{ V}$

Power Gain $|S_{21}| = f(f)$

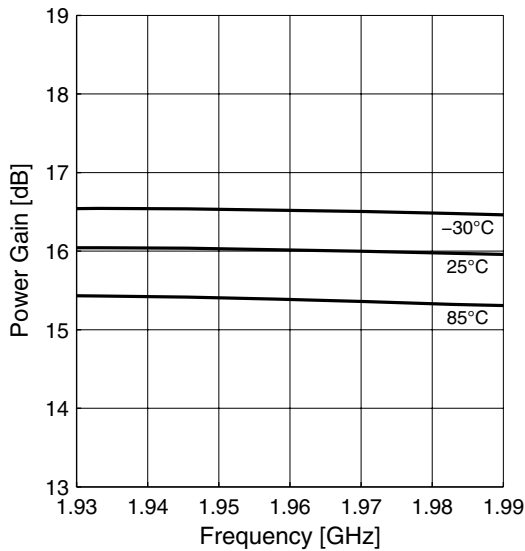

Power Gain wideband $|S_{21}| = f(f)$

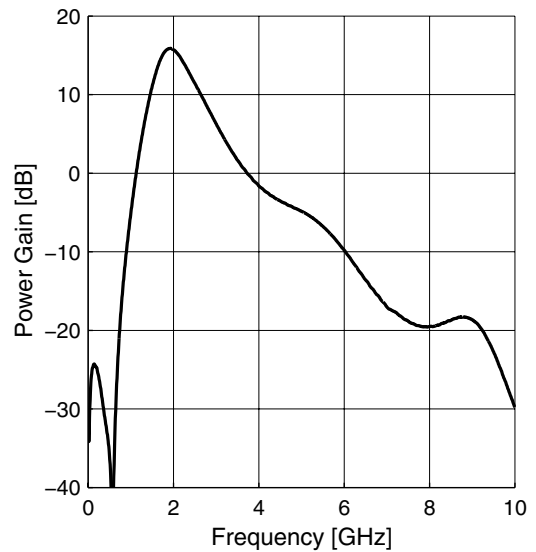

Matching $|S_{11}| = f(f)$, $|S_{22}| = f(f)$

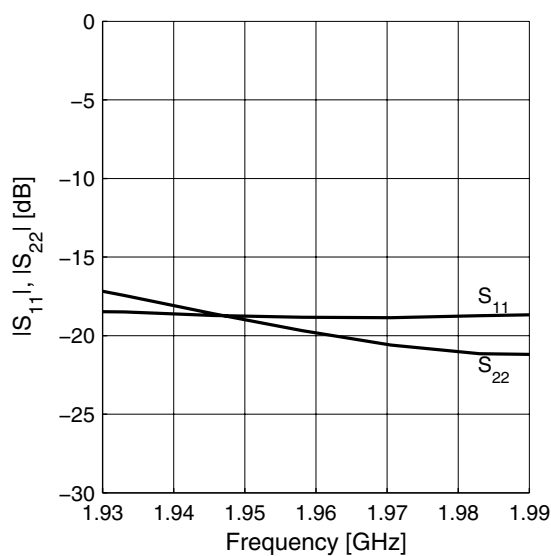

Gainstep HG-LG $|\Delta S_{21}| = f(f)$

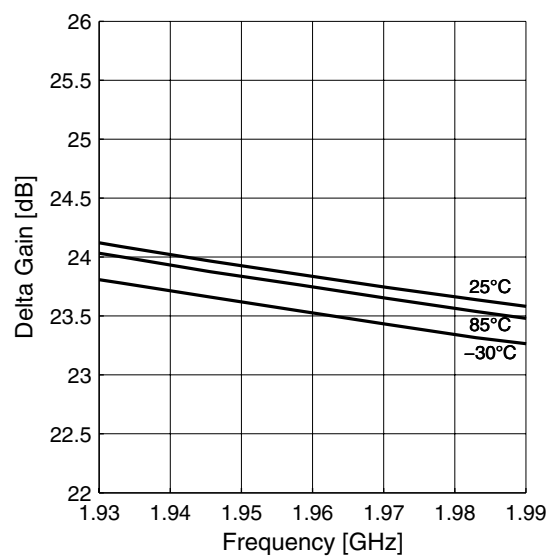

Measured Performance Mid Band (Band II) High Gain Mode vs. Temperature

Noise Figure $NF = f(f)$

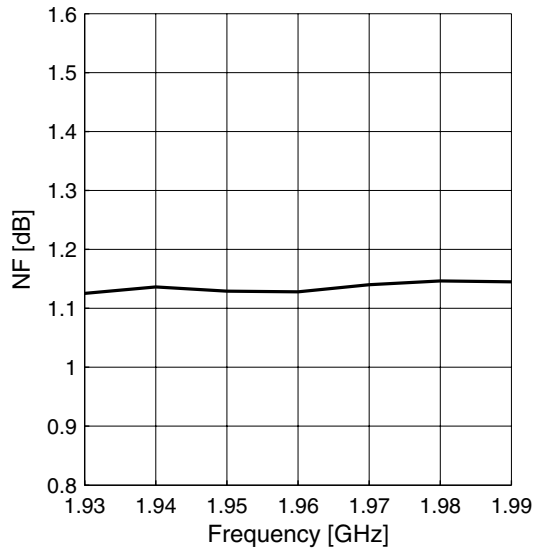

Input Compression $P1dB = f(f)$

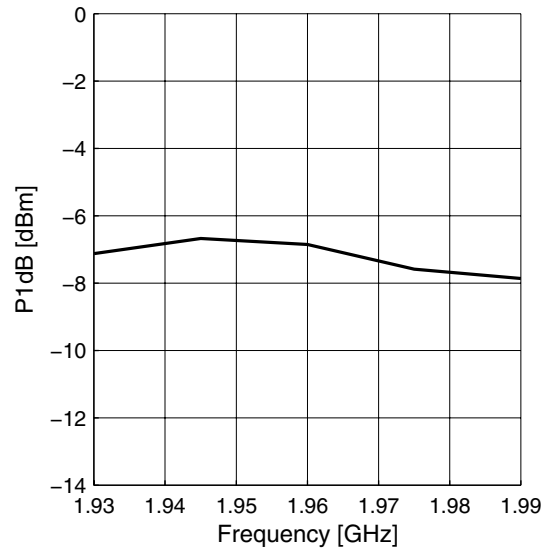

2.16 Measured Performance Mid Band (Band II) High Gain Mode vs. Temperature

$V_{CC} = 2.8\text{ V}$, $V_{GS} = 2.8\text{ V}$, $V_{EN1} = 2.8\text{ V}$, $V_{EN2} = 0\text{ V}$, $f = 1960\text{ MHz}$

Power Gain $|S_{21}| = f(T_A)$

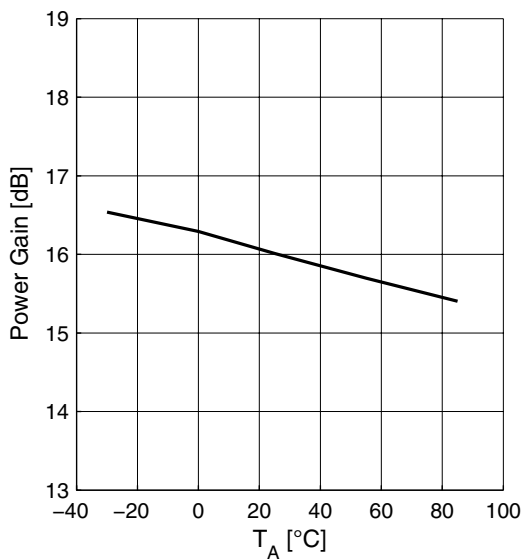

Supply Current $I_{CC} = f(T_A)$

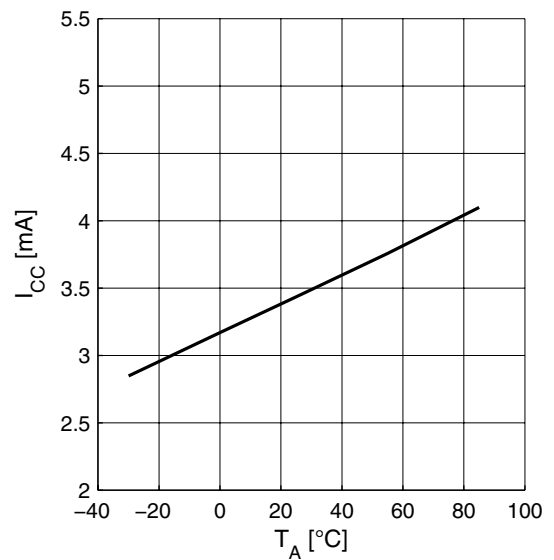

Measured Performance Mid Band (Band II) Low Gain Mode vs. Frequency

Noise Figure $NF = f(T_A)$

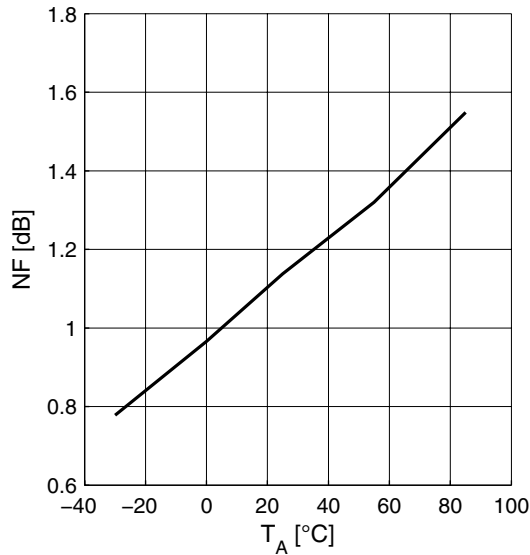

Input Compression $P1dB = f(T_A)$

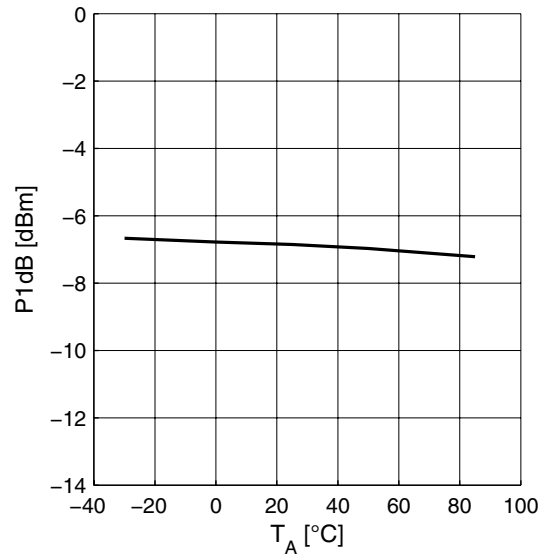

2.17 Measured Performance Mid Band (Band II) Low Gain Mode vs. Frequency

$T_A = 25^\circ\text{C}$, $V_{CC} = 2.8\text{ V}$, $V_{GS} = 0\text{ V}$, $V_{EN1} = 2.8\text{ V}$, $V_{EN2} = 0\text{ V}$

Power Gain $|S_{21}| = f(f)$

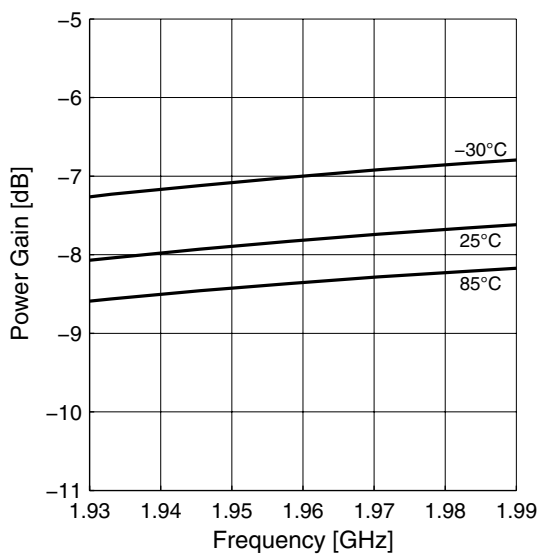

Power Gain wideband $|S_{21}| = f(f)$

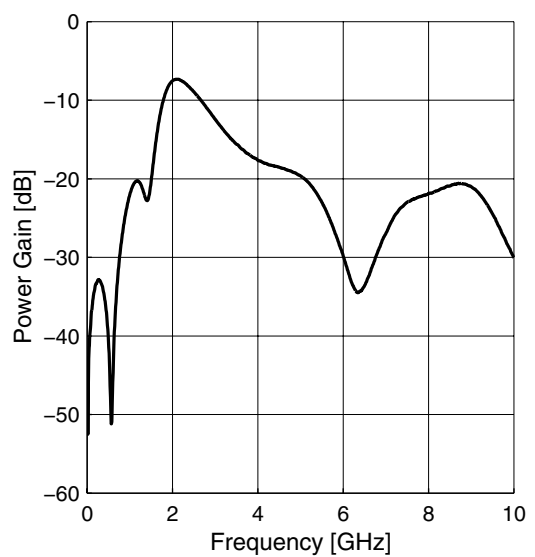

Measured Performance Mid Band (Band II) Low Gain Mode vs. Frequency

Matching $|S_{11}| = f(f)$, $|S_{22}| = f(f)$

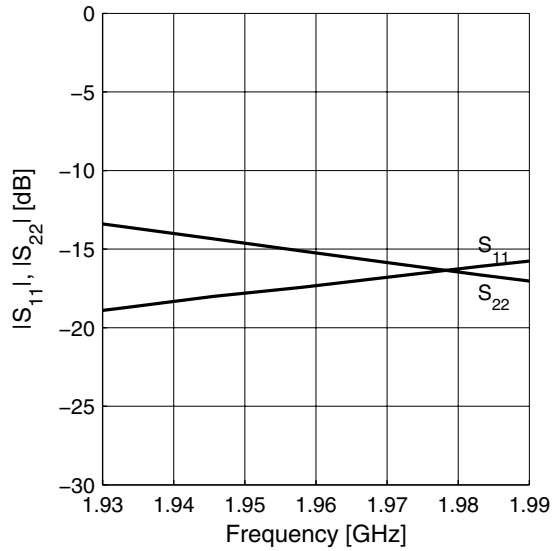

Noise Figure $NF = f(f)$

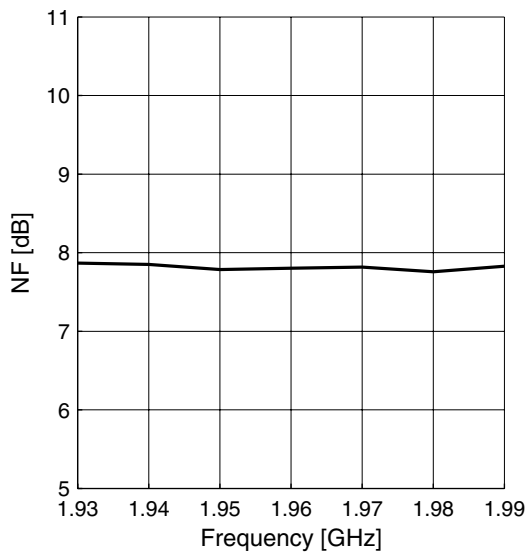

Input Compression $P1dB = f(f)$

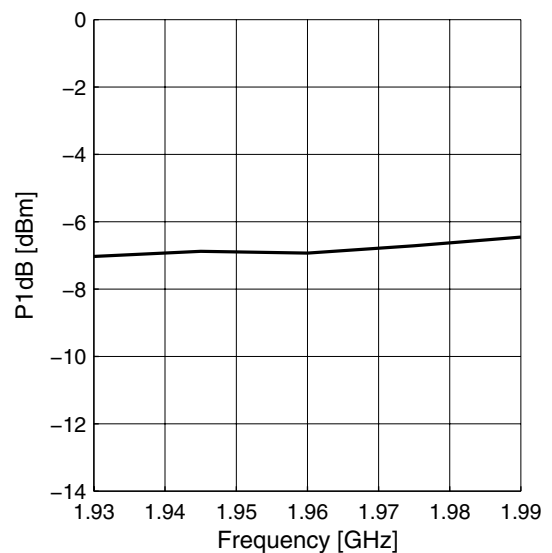

Measured Performance Mid Band (Band II) Low Gain Mode vs. Temperature

2.18 Measured Performance Mid Band (Band II) Low Gain Mode vs. Temperature

$V_{CC} = 2.8\text{ V}$, $V_{GS} = 0\text{ V}$, $V_{EN1} = 2.8\text{ V}$, $V_{EN2} = 0\text{ V}$, $f = 1960\text{ MHz}$

Power Gain $|S_{21}| = f(T_A)$

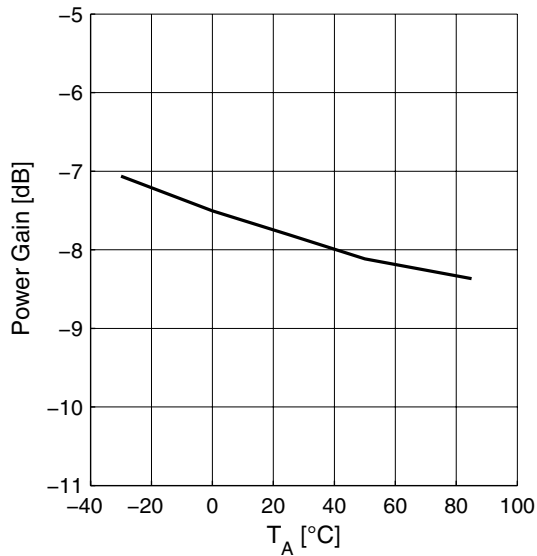

Supply Current $I_{CC} = f(T_A)$

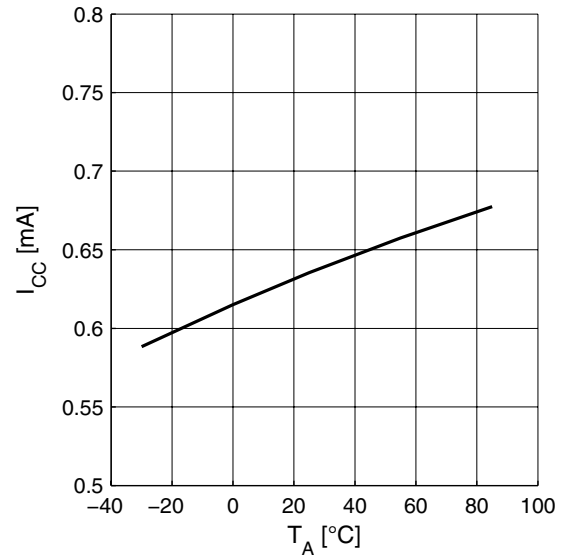

Noise Figure $NF = f(T_A)$

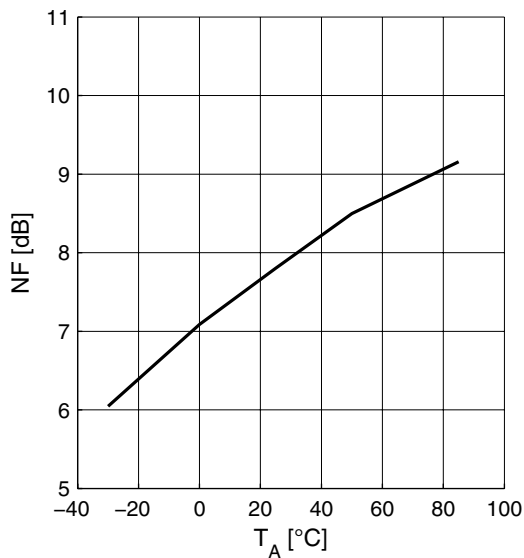

Input Compression $P1dB = f(T_A)$

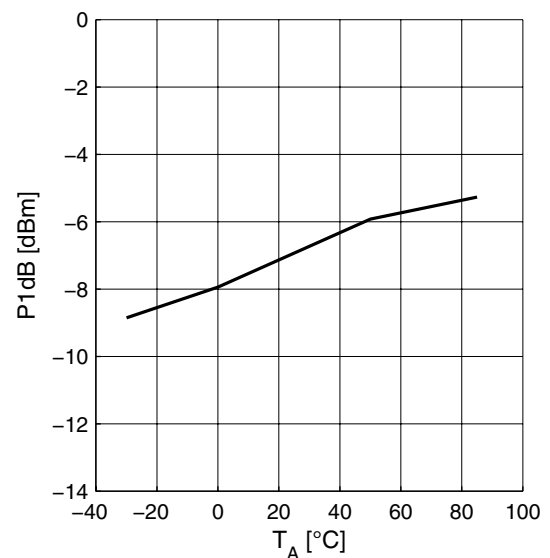

3 Application Circuit and Block Diagram

3.1 UMTS bands II and V Application Circuit Schematic

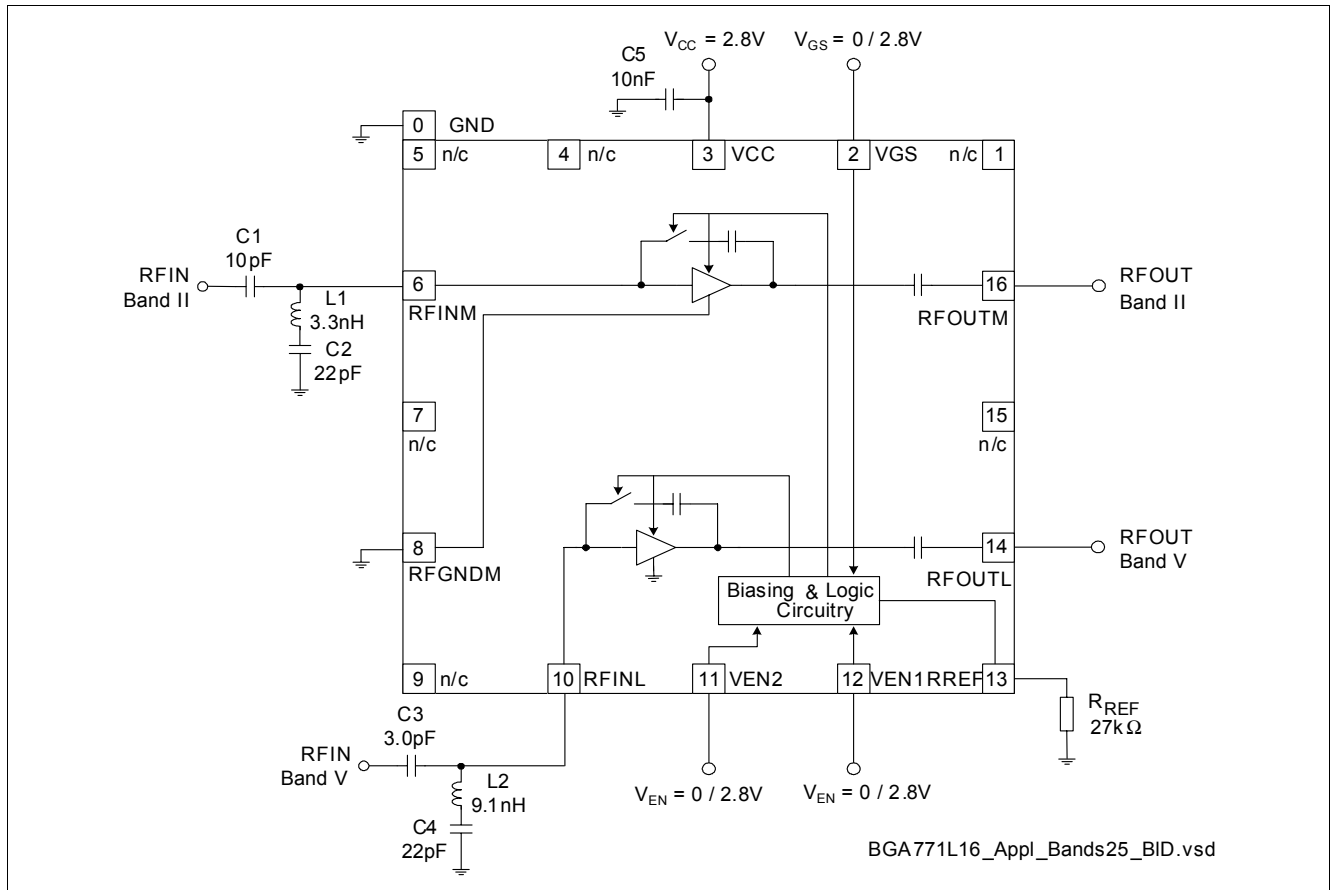

Figure 2 Application circuit with chip outline (top view)

Note: Package paddle (Pin 0) has to be RF grounded.

Table 13 Parts List

Part Number	Part Type	Manufacturer	Size	Comment
L1 ... L2	Chip inductor	Various	0402	Wirewound, Q ≈ 50
C1 ... C5	Chip capacitor	Various	0402	
RREF	Chip resistor	Various	0402	