



Chipsmall Limited consists of a professional team with an average of over 10 year of expertise in the distribution of electronic components. Based in Hongkong, we have already established firm and mutual-benefit business relationships with customers from,Europe,America and south Asia,supplying obsolete and hard-to-find components to meet their specific needs.

With the principle of "Quality Parts,Customers Priority,Honest Operation,and Considerate Service",our business mainly focus on the distribution of electronic components. Line cards we deal with include Microchip,ALPS,ROHM,Xilinx,Pulse,ON,Everlight and Freescale. Main products comprise IC,Modules,Potentiometer,IC Socket,Relay,Connector.Our parts cover such applications as commercial,industrial, and automotives areas.

We are looking forward to setting up business relationship with you and hope to provide you with the best service and solution. Let us make a better world for our industry!



Contact us

Tel: +86-755-8981 8866 Fax: +86-755-8427 6832

Email & Skype: info@chipsmall.com Web: www.chipsmall.com

Address: A1208, Overseas Decoration Building, #122 Zhenhua RD., Futian, Shenzhen, China



Ambient Light Sensor IC Series

Digital 16bit Serial Output Type Ambient Light Sensor IC

BH1726NUC

General Description

BH1726NUC is a digital Ambient Light Sensor IC with I²C bus interface. This IC is most suitable for obtaining ambient light data for adjusting LCD and backlight power of TV and mobile phone. It is capable of detecting a very wide range of illuminance.

Features

- Built-in Ircut filter
- 2 outputs with different spectral response
- Correspond to dark window because of high sensitivity
- Rejecting 50Hz/60Hz light noise
- I²C bus interface (f/s mode support)
- It is possible to select 2 type of I²C bus slave address.
- Correspond to 1.8V logic interface
- Resolution 0.0003lx/count (Typ)
(In highest gain and longest measurement time setting)

Applications

Mobile Phone, Tablet PC, Note PC, Portable Game Machine, LCD TV, Digital Camera

Key Specifications

- VCC Voltage Range: 2.3V to 3.6V
- Detection Range: 30klx (Typ)
- Current Consumption: 75μA (Typ)
- Power Down Current: 0.8μA (Typ)
- Operating Temperature Range: -40°C to +85°C

Package(s)

WS0N008X2120

W(Typ) x D(Typ) x H(Max)

2.10mm x 2.00mm x 0.6mm

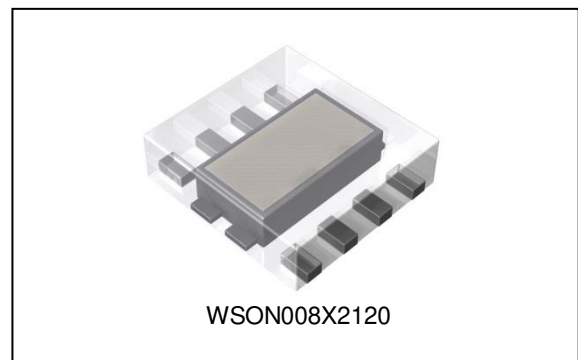

Typical Application Circuits

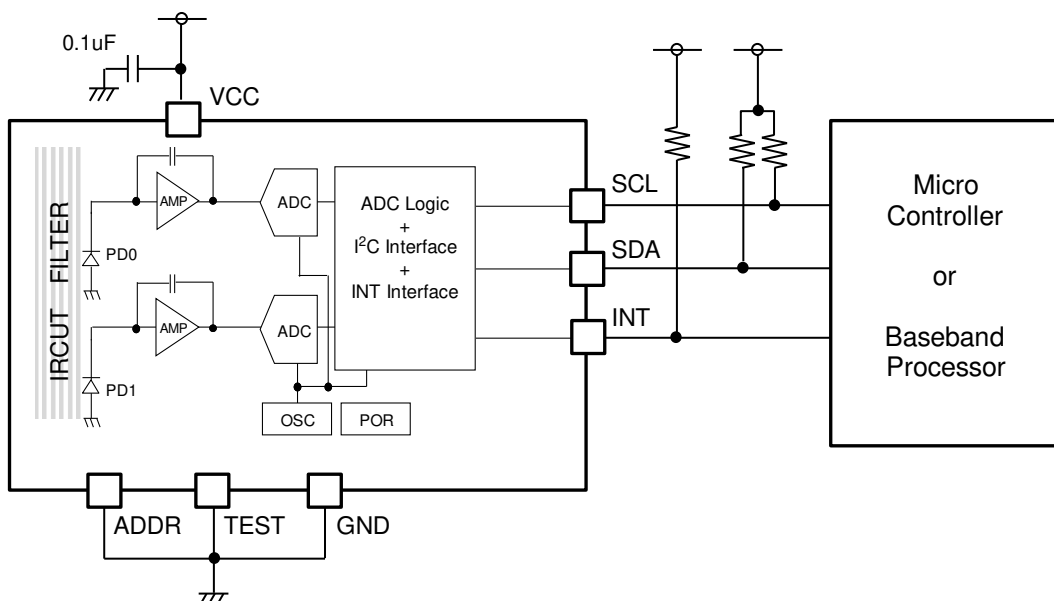

○Product structure: Silicon monolithic integrated circuit.
 ○This product does not include laser transmitter.
 ○This product includes Photo detector, (Photo Diode) inside of it.

○This product has no designed protection against radioactive rays.
 ○This product does not include optical load.

Pin Configuration

TOP VIEW

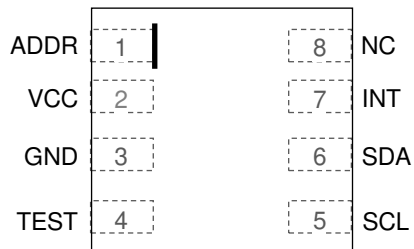

Pin Description

Pin No.	Pin Name	Function
1	ADDR	I ² C bus slave address selector
2	VCC	Power supply ^(Note 1)
3	GND	Ground
4	TEST	Test pin (Connect to GND)
5	SCL	I ² C bus serial clock
6	SDA	I ² C bus serial data
7	INT	Interrupt
8	NC	Non connect

(Note 1) Dispose a bypass capacitor as close as possible to the IC

Block Diagram

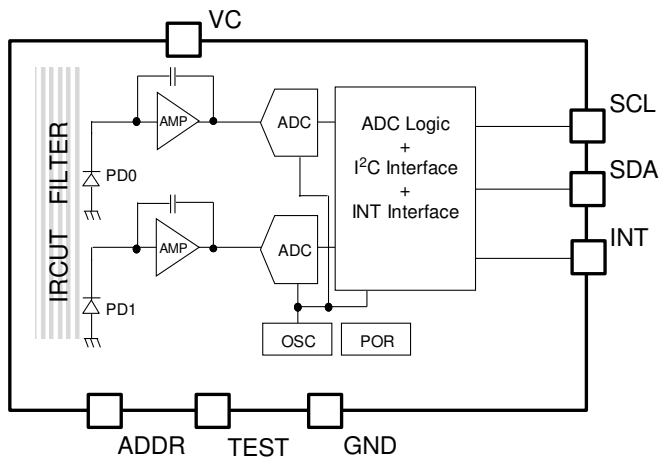

Description of Blocks

- PD0, PD1
Photodiode
- AMP
Integrated OPAMP for converting PD current to voltage.
- ADC
Analog-to-Digital Converter for obtaining 16bit digital data.
- ADC Logic + I²C Interface + INT Interface
ADC control logic and I/F logic
- OSC
Oscillator for clock of internal logic
- POR
Power ON Reset. All registers are reset after VCC is supplied.

Absolute Maximum Ratings (Ta = 25°C)

Parameter	Symbol	Rating	Unit
Supply Voltage	V _{CC_MR}	4.5	V
Input Voltage 1 [INT,SCL,SDA]	V _{IN1_MR}	-0.3 to +4.5	V
Input Voltage 2 [ADDR]	V _{IN2_MR}	-0.3 to (V _{CC} +0.3) or +4.5 whichever is less	V
Operating Temperature Range	Topr	-40 to +85	°C
Storage Temperature Range	Tstg	-40 to +100	°C
Maximum Junction Temperature	Tjmax	100	°C

Caution: Operating the IC over the absolute maximum ratings may damage the IC. The damage can either be a short circuit between pins or an open circuit between pins and the internal circuitry. Therefore, it is important to consider circuit protection measures, such as adding a fuse, in case the IC is operated over the absolute maximum ratings.

Thermal Resistance (Note 1)

Parameter	Symbol	Thermal Resistance (Typ)		Unit
		1s <small>(Note 3)</small>	2s2p <small>(Note 4)</small>	
WSON008X2120				
Junction to Ambient	θ_{JA}	384.2	54.2	°C/W
Junction to Top Characterization Parameter <small>(Note 2)</small>	Ψ_{JT}	82	12	°C/W

(Note 1)Based on JESD51-2A(Still-Air)

(Note 2)The thermal characterization parameter to report the difference between junction temperature and the temperature at the top center of the outside surface of the component package.

(Note 3)Using a PCB board based on JESD51-3.

Layer Number of Measurement Board	Material	Board Size
Single	FR-4	114.3mm x 76.2mm x 1.57mmt

Top	
Copper Pattern	Thickness
Footprints and Traces	70μm

(Note 4)Using a PCB board based on JESD51-5, 7.

Layer Number of Measurement Board	Material	Board Size	Thermal Via <small>(Note 5)</small>		
			Pitch	Diameter	
4 Layers	FR-4	114.3mm x 76.2mm x 1.6mmt	1.20mm	Φ0.30mm	
Top		2 Internal Layers		Bottom	
Copper Pattern	Thickness	Copper Pattern	Thickness	Copper Pattern	Thickness
Footprints and Traces	70μm	74.2mm x 74.2mm	35μm	74.2mm x 74.2mm	70μm

(Note 5)This thermal via connects with the copper pattern of all layers..

Recommended Operating Conditions (Ta = -40°C to +85°C)

Parameter	Symbol	Min	Typ	Max	Unit
Supply Voltage	V _{CC}	2.3	2.5	3.6	V
Input Voltage [INT,SCL,SDA]	V _{IN}	0	-	3.6	V

Electrical Characteristics (Unless otherwise specified VCC = 2.5V, Ta = 25°C, ADC_EN=1, WAIT_EN=1, ITIME=0xDA, x1 gain mode) (Note 1)

Parameter	Symbol	Min	Typ	Max	Unit	Conditions
Supply Current	Icc1	-	75	125	μA	E _V = 100 lx
Power Down Current	Icc2	-	0.8	1.5	μA	No input Light All registers are default.
ADC Count Value in DATA0	D1k_0	3400	4000	4600	count	E _V = 1000 lx
ADC Count Value in DATA1	D1k_1	425	500	575	count	E _V = 1000 lx
Dark (0 lx) Sensor Out in DATA0	S0_0	-	0	2	count	No input Light
Dark (0 lx) Sensor Out in DATA1	S0_1	-	0	2	count	No input Light
Measurement Time	Tmt1	123.3	137.0	150.7	ms	ITIME = 0xCE
Internal Clock Period	Tint	-	2.8	4.0	μs	
Interval Time	Twt	-	300	430	ms	
INT Output 'L' Voltage	V _{INTL}	0	-	0.4	V	IOL = 3mA
SCL SDA Input 'H' Voltage	V _{IH}	1.26	-	-	V	
SCL SDA Input 'L' Voltage	V _{IL}	-	-	0.54	V	
SDA Output 'L' Voltage	V _{OL}	0	-	0.4	V	IOL = 3mA
ADDR Input 'H' Voltage	V _{ADDRH}	0.7*VCC	-	-	V	
ADDR Input 'L' Voltage	V _{ADDRL}	-	-	0.3*VCC	V	

(Note 1) White LED is used as optical source.

Typical Performance Curves

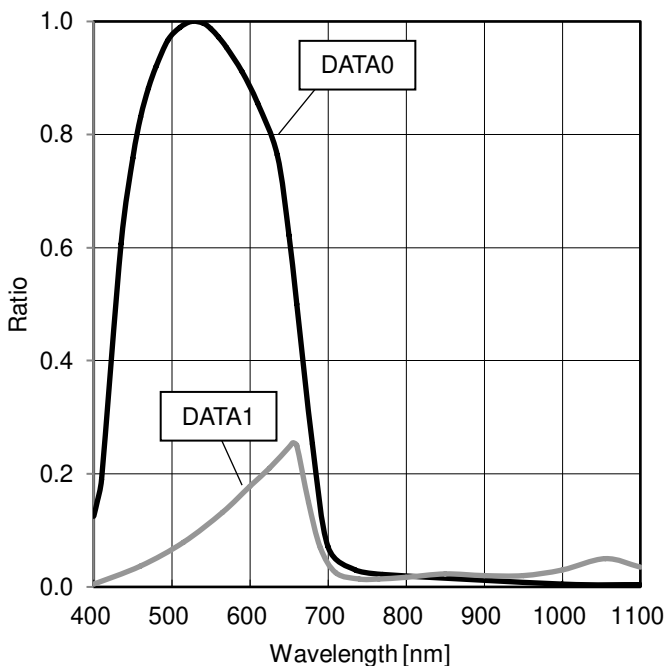
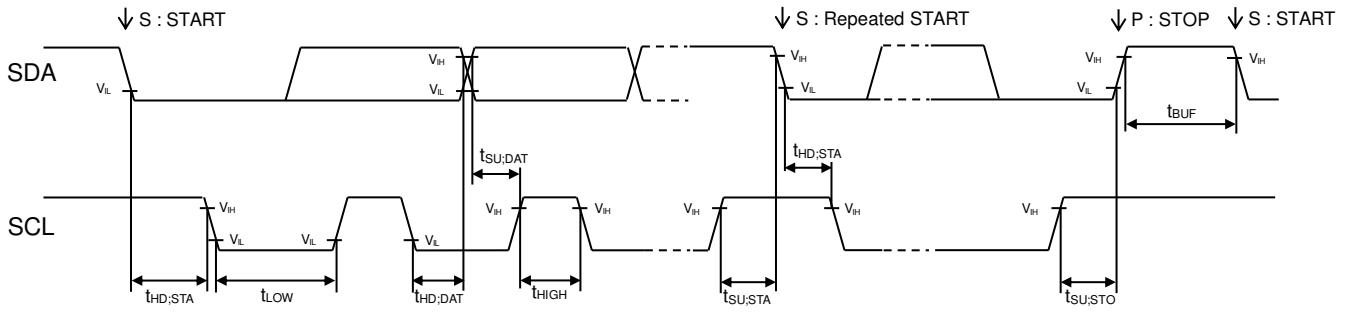

Figure 1. Ratio vs Wavelength
(Spectral Response)

I²C bus Timing Characteristics (Unless otherwise specified VCC = 2.5V, Ta = 25°C)



Parameter	Symbol	Min	Typ	Max	Unit	Conditions
SCL Clock frequency	f _{SCL}	0	-	400	kHz	
'L' Period of the SCL Clock	t _{LOW}	1.3	-	-	μs	
'H' Period of the SCL Clock	t _{HIGH}	0.6	-	-	μs	
Setup Time for Repeated START	t _{SU;STA}	0.6	-	-	μs	
Hold Time for START	t _{HD;STA}	0.6	-	-	μs	
Data Setup Time	t _{SU;DAT}	100	-	-	ns	
Data Hold Time	t _{HD;DAT}	0	-	-	μs	
Setup Time for STOP	t _{SU;STO}	0.6	-	-	μs	
Bus Free Time between STOP and START	t _{BUF}	1.3	-	-	μs	

I²C bus Communication

1. Write Format

(1) Indicate register address

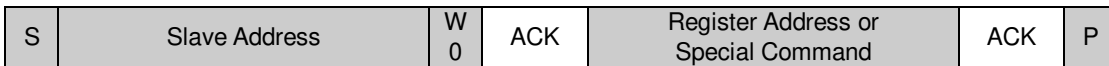

(2) Write data after indicating register address

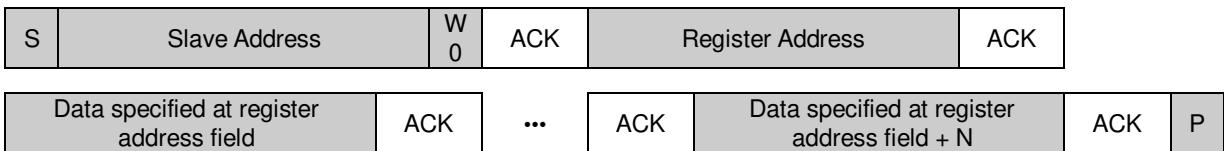

2. Read Format

(1) Read data after indicating register address (Master issues restart condition)

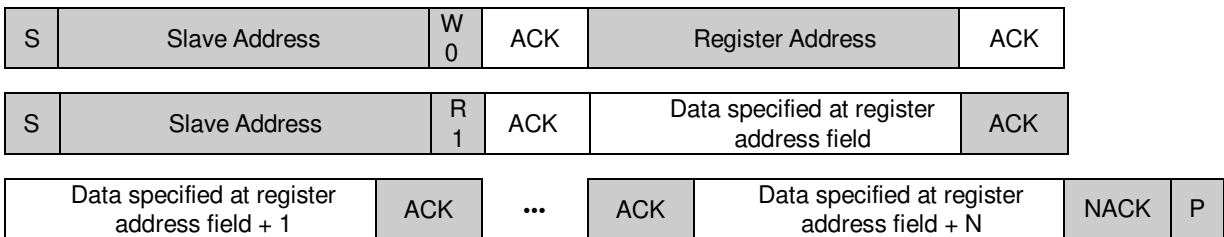

(2) Read data from the specified register

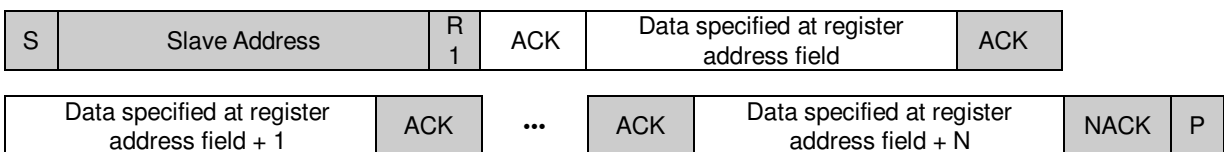

I²C bus Slave address

The slave address is selectable from 2 addresses by ADDR pin.

ADDR	Slave Address
L	0101001
H	0111001

Register MAP (Note 1)

Register Address [4:0]	Register Name	R/W	D7	D6	D5	D4	D3	D2	D1	D0
--	COMMAND	W	COMMAND CODE [7:0]							
0x00	CONTROL	RW	0	0	ADC_INTR	ADC_VALID	0	0	ADC_EN	POWER
0x01	TIMING	RW	ITIME [7:0]							
0x02	INTERRUPT	RW	0	0	INT_LATCH	INT_EN	PERSIST [3:0]			
0x03	TH_LOW	RW	TH_LOW_data [7:0]							
0x04		RW	TH_LOW_data [15:8]							
0x05	TH_HIGH	RW	TH_HIGH_data [7:0]							
0x06		RW	TH_HIGH_data [15:8]							
0x07	GAIN	RW	0	0	0	0	DATA0_GAIN [1:0]	DATA1_GAIN [1:0]		
0x12	PART ID	R	PART ID [7:0]							
0x14	DATA0	R	DATA0_data [7:0]							
0x15		R	DATA0_data [15:8]							
0x16	DATA1	R	DATA1_data [7:0]							
0x17		R	DATA1_data [15:8]							
0x18	WAIT	RW	0	0	0	0	0	0	0	WAIT_EN

(Note 1) Do not write any commands to other address except above. Do not write '1' to the field in which value is '0' in above table.

COMMAND

Fields	Function
COMMAND CODE	100_Register Address[4:0]: Command to indicate register address 111_00001: Interrupt reset (Special Command) 111_00100: Software reset (Special Command) Don't input the other command. All registers are reset and this IC becomes power down state by software reset.

default value 0x00

(0x00) CONTROL

Fields	Function
ADC_INTR	Interrupt status output (Read only register) 0 : Interrupt is inactive. 1 : Interrupt is active.
ADC_VALID	Data register(DATA0, DATA1) status output (Read only register) 0 : Data registers are not updated after last reading. 1 : Data registers are updated after last reading.
ADC_EN	0 : ADC measurement stop. 1 : ADC measurement start.
POWER	0 : ADC power down. 1 : ADC power on.

default value 0x00

(0x01) TIMING

Fields	Function
ITIME	$\text{Integration Time (ITIME_ms)} = \text{Tint} * 964 * (256 - \text{ITIME})$ $\text{Measurement time (Tmt)} = \text{ITIME_ms} + \text{Tint} * 714$ ITIME determines integration time. Regarding integration time and measurement result, please refer to "ALS Sensitivity Adjustment Function"

default value 0xDA

(0x02) INTERRUPT

Fields	Function
INT_LATCH	0 : LATCH mode 1 : UNLATCH mode
INT_EN	0 : Interrupt function is invalid. 1 : Interrupt function is valid.
PERSIST	Interrupt persistence function. 0000 : Interrupt becomes active at each measurement end. 0001 : Interrupt status is updated at each measurement end. 0010 : Interrupt status is updated if 2 consecutive threshold judgments are the same. 0011 : Interrupt status is updated if 3 consecutive threshold judgments are the same. ⋮ ⋮ 1110 : Interrupt status is updated if 14 consecutive threshold judgments are the same. 1111 : Interrupt status is updated if 15 consecutive threshold judgments are the same

default value 0x01

(0x03 / 0x04) TH_LOW

Fields	Function
TH_LOW_data [15:0]	Interrupt threshold lower level

default value 0x0000

(0x05 / 0x06) TH_HIGH

Fields	Function
TH_HIGH_data [15:0]	Interrupt threshold upper level

default value 0xFFFF

(0x07) GAIN

Fields	Function
DATA0_GAIN	Gain setting of ADC DATA0 00 : x1 gain mode 01 : x2 gain mode 10 : x64 gain mode 11 : x128 gain mode
DATA1_GAIN	Gain setting of ADC DATA1 00 : x1 gain mode 01 : x2 gain mode 10 : x64 gain mode 11 : x128 gain mode

default value 0x00

(0x12) PART ID

Fields	Function
PART ID	Part ID : 0x72

(0x14 / 0x15) DATA0

Fields	Function
DATA0_data [15:0]	DATA0 Measurement result

default value 0x0000

(0x16 / 0x17) DATA1

Fields	Function
DATA1_data [15:0]	DATA1 Measurement result

default value 0x0000

(0x18) WAIT

Fields	Function
WAIT_EN	0 : There is no interval. 1 : There is interval (Twt) after each measurement (Low current consumption mode)

default value 0x00

Measurement Procedure

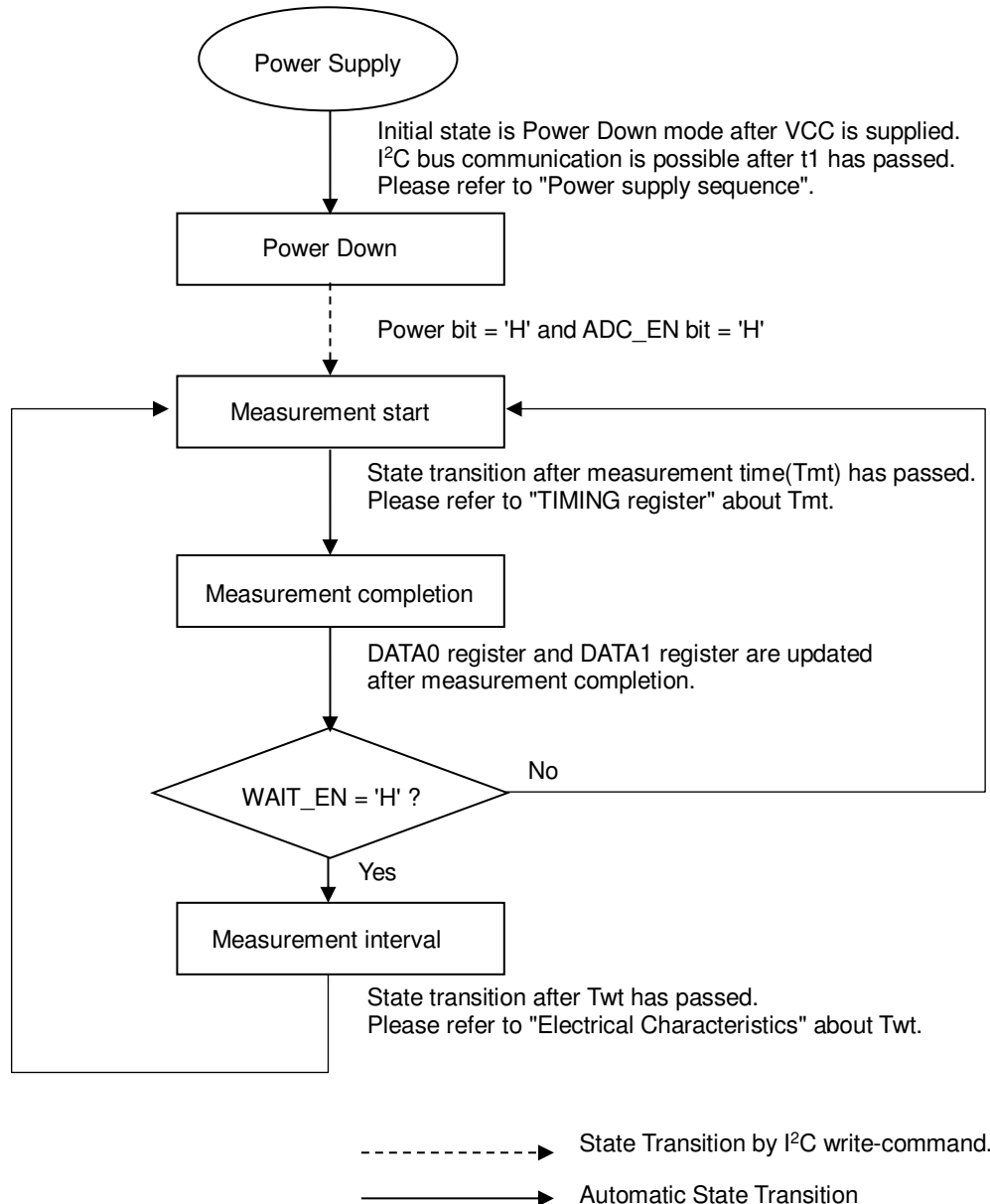

Interrupt Function

Interrupt function compares DATA0 measurement result to preset interrupt threshold level. This IC uses two threshold levels (upper and lower). If measurement result is outside of the two thresholds, INT pin outputs 'L'. Interrupt function is able to set at INTERRUPT register. And interrupt threshold is defined at TH_HIGH register and TH_LOW register.

INT pin is high impedance when VCC is supplied.

To clear interrupt

- 1) Interrupt output reset of special command
- 2) Master reads CONTROL register
- 3) Software reset of special command

EX) Interrupt behavior example

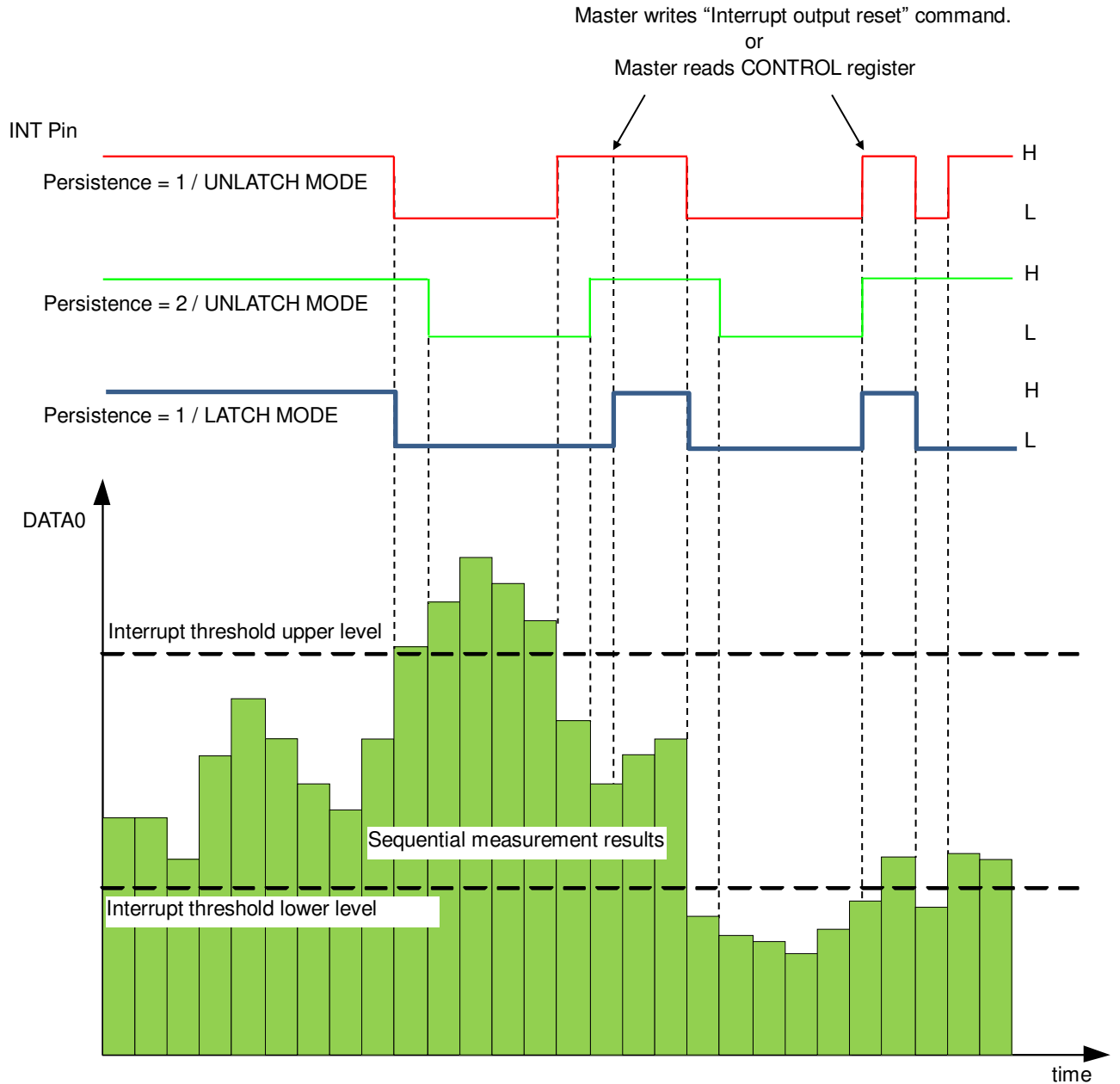

Power supply sequence

ALL register of this IC is reset when VCC powers up. There are some notes about power up and down sequence as shown below.

1. Power ON Time: t_1
More than 2ms is needed to activate this IC after VCC becomes more than 2.3V from less than 0.4V.
2. Power OFF time: t_2
More than 1ms ($VCC < 0.4V$) is needed before supplying power to this IC.

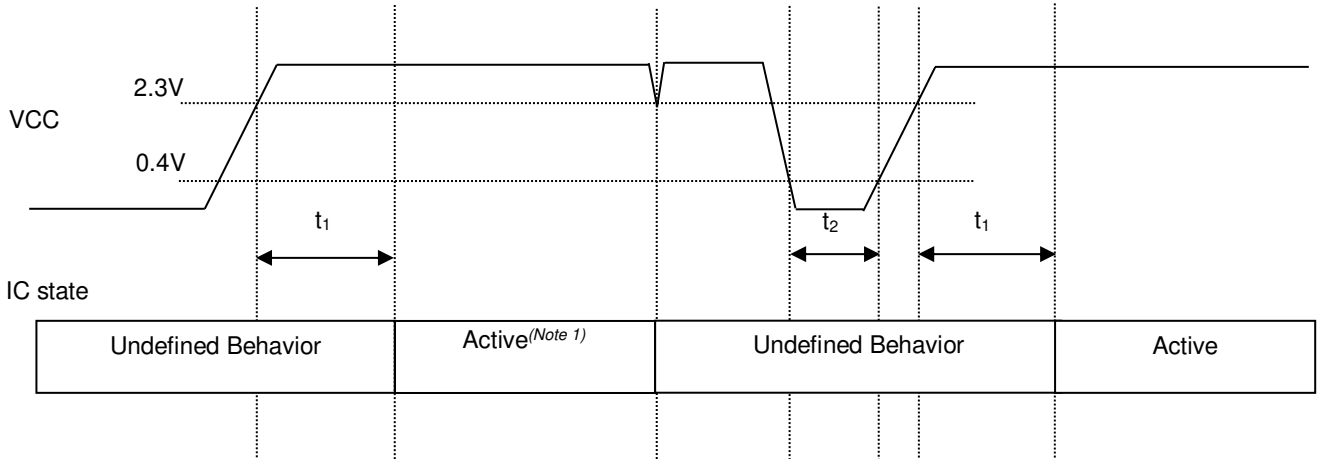

(Note1) "Active" state is that this IC works and accept I²C bus access correctly.

ALS Sensitivity Adjustment Function

This IC is capable of changing its ALS sensitivity. This is used to compensate the effect of attenuation by the optical window. Adjustment is done by changing the measurement time. For example, when transmission rate of optical window is 1/n (measurement result becomes 1/n times if optical window is set), the effect of optical window is compensated by changing sensor sensitivity from default to n times.

Optical design for the device

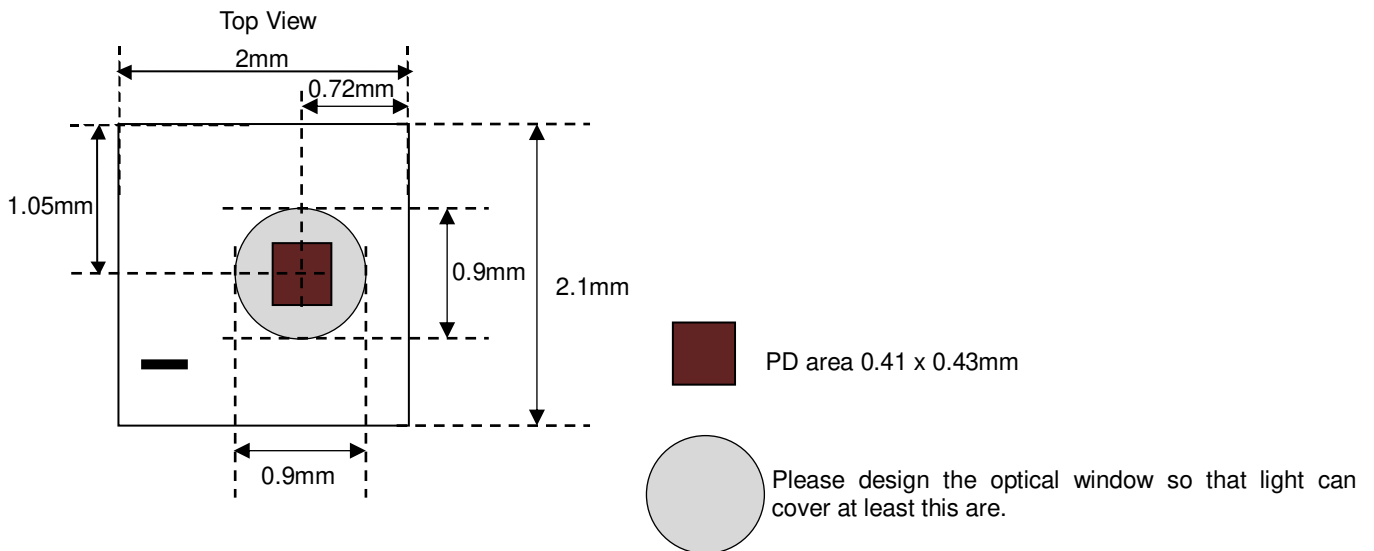

I/O Equivalent Circuit

Pin Name	Equivalent Circuit
ADDR	
TEST	
SCL	
SDA	
INT	

Operational Notes

- 1. Reverse Connection of Power Supply**

Connecting the power supply in reverse polarity can damage the IC. Take precautions against reverse polarity when connecting the power supply, such as mounting an external diode between the power supply and the IC's power supply pins.
- 2. Power Supply Lines**

Design the PCB layout pattern to provide low impedance supply lines. Furthermore, connect a capacitor to ground at all power supply pins. Consider the effect of temperature and aging on the capacitance value when using electrolytic capacitors.
- 3. Ground Voltage**

Ensure that no pins are at a voltage below that of the ground pin at any time, even during transient condition.
- 4. Ground Wiring Pattern**

When using both small-signal and large-current ground traces, the two ground traces should be routed separately but connected to a single ground at the reference point of the application board to avoid fluctuations in the small-signal ground caused by large currents. Also ensure that the ground traces of external components do not cause variations on the ground voltage. The ground lines must be as short and thick as possible to reduce line impedance.
- 5. Thermal Consideration**

Should by any chance the maximum junction temperature rating be exceeded the rise in temperature of the chip may result in deterioration of the properties of the chip. In case of exceeding this absolute maximum rating, increase the board size and copper area to prevent exceeding the maximum junction temperature rating..
- 6. Recommended Operating Conditions**

These conditions represent a range within which the expected characteristics of the IC can be approximately obtained. The electrical characteristics are guaranteed under the conditions of each parameter.
- 7. Inrush Current**

When power is first supplied to the IC, it is possible that the internal logic may be unstable and inrush current may flow instantaneously due to the internal powering sequence and delays, especially if the IC has more than one power supply. Therefore, give special consideration to power coupling capacitance, power wiring, width of ground wiring, and routing of connections.
- 8. Operation Under Strong Electromagnetic Field**

Operating the IC in the presence of a strong electromagnetic field may cause the IC to malfunction.
- 9. Testing on Application Boards**

When testing the IC on an application board, connecting a capacitor directly to a low-impedance output pin may subject the IC to stress. Always discharge capacitors completely after each process or step. The IC's power supply should always be turned off completely before connecting or removing it from the test setup during the inspection process. To prevent damage from static discharge, ground the IC during assembly and use similar precautions during transport and storage.
- 10. Inter-pin Short and Mounting Errors**

Ensure that the direction and position are correct when mounting the IC on the PCB. Incorrect mounting may result in damaging the IC. Avoid nearby pins being shorted to each other especially to ground, power supply and output pin. Inter-pin shorts could be due to many reasons such as metal particles, water droplets (in very humid environment) and unintentional solder bridge deposited in between pins during assembly to name a few.
- 11. Unused Input Pins**

Input pins of an IC are often connected to the gate of a MOS transistor. The gate has extremely high impedance and extremely low capacitance. If left unconnected, the electric field from the outside can easily charge it. The small charge acquired in this way is enough to produce a significant effect on the conduction through the transistor and cause unexpected operation of the IC. So unless otherwise specified, unused input pins should be connected to the power supply or ground line.

Operational Notes – continued

12. Regarding the Input Pin of the IC

This monolithic IC contains P+ isolation and P substrate layers between adjacent elements in order to keep them isolated. P-N junctions are formed at the intersection of the P layers with the N layers of other elements, creating a parasitic diode or transistor. For example (refer to figure below):

When $GND > Pin A$ and $GND > Pin B$, the P-N junction operates as a parasitic diode.

When $GND > Pin B$, the P-N junction operates as a parasitic transistor.

Parasitic diodes inevitably occur in the structure of the IC. The operation of parasitic diodes can result in mutual interference among circuits, operational faults, or physical damage. Therefore, conditions that cause these diodes to operate, such as applying a voltage lower than the GND voltage to an input pin (and thus to the P substrate) should be avoided.

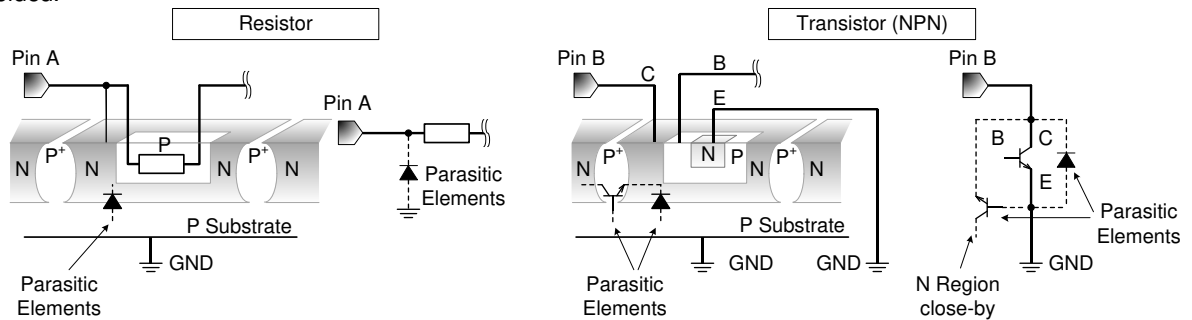

Figure 2. Example of monolithic IC structure

13. Ceramic Capacitor

When using a ceramic capacitor, determine the dielectric constant considering the change of capacitance with temperature and the decrease in nominal capacitance due to DC bias and others.

14. Area of Safe Operation (ASO)

Operate the IC such that the output voltage, output current, and power dissipation are all within the Area of Safe Operation (ASO).

Ordering Information

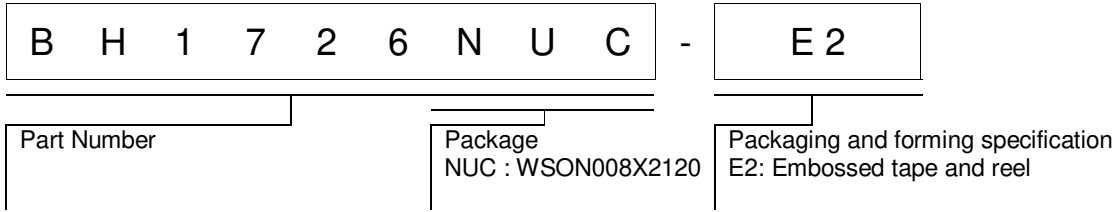

Marking Diagram

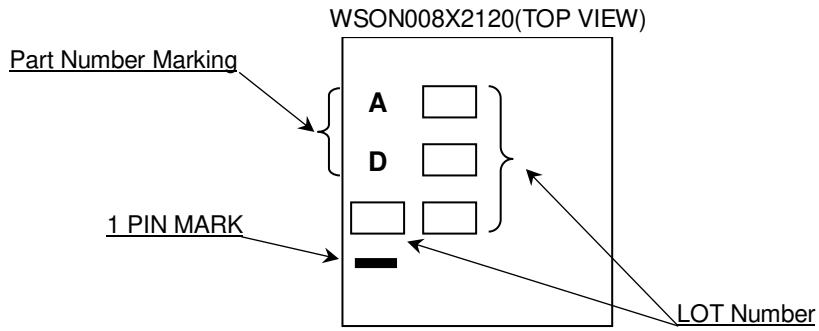

Physical Dimension, Tape and Reel Information

Package Name	WSON008X2120
--------------	--------------

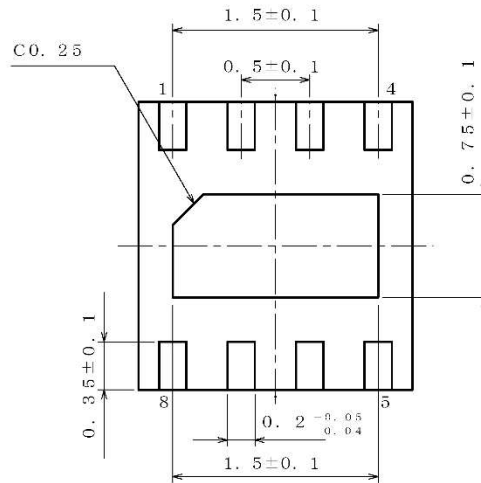
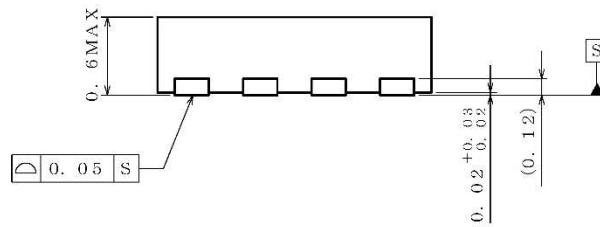
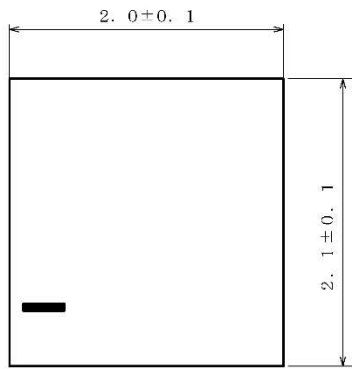

(UNIT : mm)
 PKG : WSON008X2120
 Drawing No. EX071-5001

< Tape and Reel Information >

Tape	Embossed carrier tape (with dry pack)
Quantity	4000pcs
Direction of feed	E2 The direction is the pin 1 of product is at the upper left when you hold reel on the left hand and you pull out the tape on the right hand

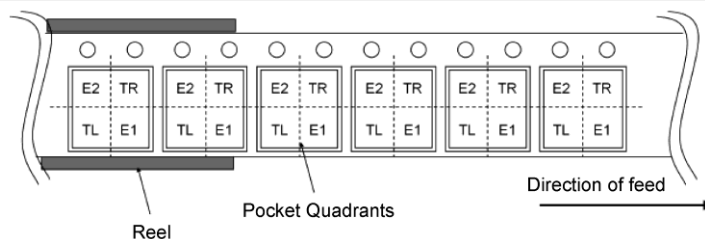

Revision History

Date	Revision	Changes
28.Apr.2016	001	New Release
05.Jun.2018	002	Specified value modification (Electrical Characteristics)
08.Aug.2018	003	Correction of error about Interrupt Function

Notice

Precaution on using ROHM Products

- Our Products are designed and manufactured for application in ordinary electronic equipment (such as AV equipment, OA equipment, telecommunication equipment, home electronic appliances, amusement equipment, etc.). If you intend to use our Products in devices requiring extremely high reliability (such as medical equipment ^(Note 1), transport equipment, traffic equipment, aircraft/spacecraft, nuclear power controllers, fuel controllers, car equipment including car accessories, safety devices, etc.) and whose malfunction or failure may cause loss of human life, bodily injury or serious damage to property ("Specific Applications"), please consult with the ROHM sales representative in advance. Unless otherwise agreed in writing by ROHM in advance, ROHM shall not be in any way responsible or liable for any damages, expenses or losses incurred by you or third parties arising from the use of any ROHM's Products for Specific Applications.

(Note1) Medical Equipment Classification of the Specific Applications

JAPAN	USA	EU	CHINA
CLASS III	CLASS III	CLASS II b	CLASS III
CLASS IV		CLASS III	

- ROHM designs and manufactures its Products subject to strict quality control system. However, semiconductor products can fail or malfunction at a certain rate. Please be sure to implement, at your own responsibilities, adequate safety measures including but not limited to fail-safe design against the physical injury, damage to any property, which a failure or malfunction of our Products may cause. The following are examples of safety measures:
 - Installation of protection circuits or other protective devices to improve system safety
 - Installation of redundant circuits to reduce the impact of single or multiple circuit failure
- Our Products are designed and manufactured for use under standard conditions and not under any special or extraordinary environments or conditions, as exemplified below. Accordingly, ROHM shall not be in any way responsible or liable for any damages, expenses or losses arising from the use of any ROHM's Products under any special or extraordinary environments or conditions. If you intend to use our Products under any special or extraordinary environments or conditions (as exemplified below), your independent verification and confirmation of product performance, reliability, etc. prior to use, must be necessary:
 - Use of our Products in any types of liquid, including water, oils, chemicals, and organic solvents
 - Use of our Products outdoors or in places where the Products are exposed to direct sunlight or dust
 - Use of our Products in places where the Products are exposed to sea wind or corrosive gases, including Cl₂, H₂S, NH₃, SO₂, and NO₂
 - Use of our Products in places where the Products are exposed to static electricity or electromagnetic waves
 - Use of our Products in proximity to heat-producing components, plastic cords, or other flammable items
 - Sealing or coating our Products with resin or other coating materials
 - Use of our Products without cleaning residue of flux (even if you use no-clean type fluxes, cleaning residue of flux is recommended); or Washing our Products by using water or water-soluble cleaning agents for cleaning residue after soldering
 - Use of the Products in places subject to dew condensation
- The Products are not subject to radiation-proof design.
- Please verify and confirm characteristics of the final or mounted products in using the Products.
- In particular, if a transient load (a large amount of load applied in a short period of time, such as pulse. is applied, confirmation of performance characteristics after on-board mounting is strongly recommended. Avoid applying power exceeding normal rated power; exceeding the power rating under steady-state loading condition may negatively affect product performance and reliability.
- De-rate Power Dissipation depending on ambient temperature. When used in sealed area, confirm that it is the use in the range that does not exceed the maximum junction temperature.
- Confirm that operation temperature is within the specified range described in the product specification.
- ROHM shall not be in any way responsible or liable for failure induced under deviant condition from what is defined in this document.

Precaution for Mounting / Circuit board design

- When a highly active halogenous (chlorine, bromine, etc.) flux is used, the residue of flux may negatively affect product performance and reliability.
- In principle, the reflow soldering method must be used on a surface-mount products, the flow soldering method must be used on a through hole mount products. If the flow soldering method is preferred on a surface-mount products, please consult with the ROHM representative in advance.

For details, please refer to ROHM Mounting specification

Precautions Regarding Application Examples and External Circuits

1. If change is made to the constant of an external circuit, please allow a sufficient margin considering variations of the characteristics of the Products and external components, including transient characteristics, as well as static characteristics.
2. You agree that application notes, reference designs, and associated data and information contained in this document are presented only as guidance for Products use. Therefore, in case you use such information, you are solely responsible for it and you must exercise your own independent verification and judgment in the use of such information contained in this document. ROHM shall not be in any way responsible or liable for any damages, expenses or losses incurred by you or third parties arising from the use of such information.

Precaution for Electrostatic

This Product is electrostatic sensitive product, which may be damaged due to electrostatic discharge. Please take proper caution in your manufacturing process and storage so that voltage exceeding the Products maximum rating will not be applied to Products. Please take special care under dry condition (e.g. Grounding of human body / equipment / solder iron, isolation from charged objects, setting of ionizer, friction prevention and temperature / humidity control).

Precaution for Storage / Transportation

1. Product performance and soldered connections may deteriorate if the Products are stored in the places where:
 - [a] the Products are exposed to sea winds or corrosive gases, including Cl₂, H₂S, NH₃, SO₂, and NO₂
 - [b] the temperature or humidity exceeds those recommended by ROHM
 - [c] the Products are exposed to direct sunshine or condensation
 - [d] the Products are exposed to high Electrostatic
2. Even under ROHM recommended storage condition, solderability of products out of recommended storage time period may be degraded. It is strongly recommended to confirm solderability before using Products of which storage time is exceeding the recommended storage time period.
3. Store / transport cartons in the correct direction, which is indicated on a carton with a symbol. Otherwise bent leads may occur due to excessive stress applied when dropping of a carton.
4. Use Products within the specified time after opening a humidity barrier bag. Baking is required before using Products of which storage time is exceeding the recommended storage time period.

Precaution for Product Label

A two-dimensional barcode printed on ROHM Products label is for ROHM's internal use only.

Precaution for Disposition

When disposing Products please dispose them properly using an authorized industry waste company.

Precaution for Foreign Exchange and Foreign Trade act

Since concerned goods might be fallen under listed items of export control prescribed by Foreign exchange and Foreign trade act, please consult with ROHM in case of export.

Precaution Regarding Intellectual Property Rights

1. All information and data including but not limited to application example contained in this document is for reference only. ROHM does not warrant that foregoing information or data will not infringe any intellectual property rights or any other rights of any third party regarding such information or data.
2. ROHM shall not have any obligations where the claims, actions or demands arising from the combination of the Products with other articles such as components, circuits, systems or external equipment (including software).
3. No license, expressly or implied, is granted hereby under any intellectual property rights or other rights of ROHM or any third parties with respect to the Products or the information contained in this document. Provided, however, that ROHM will not assert its intellectual property rights or other rights against you or your customers to the extent necessary to manufacture or sell products containing the Products, subject to the terms and conditions herein.

Other Precaution

1. This document may not be reprinted or reproduced, in whole or in part, without prior written consent of ROHM.
2. The Products may not be disassembled, converted, modified, reproduced or otherwise changed without prior written consent of ROHM.
3. In no event shall you use in any way whatsoever the Products and the related technical information contained in the Products or this document for any military purposes, including but not limited to, the development of mass-destruction weapons.
4. The proper names of companies or products described in this document are trademarks or registered trademarks of ROHM, its affiliated companies or third parties.

General Precaution

1. Before you use our Products, you are requested to carefully read this document and fully understand its contents. ROHM shall not be in any way responsible or liable for failure, malfunction or accident arising from the use of any ROHM's Products against warning, caution or note contained in this document.
2. All information contained in this document is current as of the issuing date and subject to change without any prior notice. Before purchasing or using ROHM's Products, please confirm the latest information with a ROHM sales representative.
3. The information contained in this document is provided on an "as is" basis and ROHM does not warrant that all information contained in this document is accurate and/or error-free. ROHM shall not be in any way responsible or liable for any damages, expenses or losses incurred by you or third parties resulting from inaccuracy or errors of or concerning such information.



BH1726NUC - Web Page

[Distribution Inventory](#)

Part Number	BH1726NUC
Package	WSON008X2120
Unit Quantity	4000
Minimum Package Quantity	4000
Packing Type	Taping
Constitution Materials List	inquiry
RoHS	Yes