



Chipsmall Limited consists of a professional team with an average of over 10 year of expertise in the distribution of electronic components. Based in Hongkong, we have already established firm and mutual-benefit business relationships with customers from,Europe,America and south Asia,supplying obsolete and hard-to-find components to meet their specific needs.

With the principle of “Quality Parts,Customers Priority,Honest Operation,and Considerate Service”,our business mainly focus on the distribution of electronic components. Line cards we deal with include Microchip,ALPS,ROHM,Xilinx,Pulse,ON,Everlight and Freescale. Main products comprise IC,Modules,Potentiometer,IC Socket,Relay,Connector.Our parts cover such applications as commercial,industrial, and automotives areas.

We are looking forward to setting up business relationship with you and hope to provide you with the best service and solution. Let us make a better world for our industry!



## Contact us

Tel: +86-755-8981 8866 Fax: +86-755-8427 6832

Email & Skype: info@chipsmall.com Web: www.chipsmall.com

Address: A1208, Overseas Decoration Building, #122 Zhenhua RD., Futian, Shenzhen, China



D/A Converter Series for Electronic Adjustments

# Standard 8bit 8ch Type D/A Converters

**BH2226FV, BH2226F**

No.09052EBT05

## ●Description

The BH2226FV, BH2226F is an 8bit R-2R-type D/A converter with 8 channels. The D/A converter output and serial / parallel conversion function can be switched with one command, and a built-in RESET function ensures that the output voltage at all channels is Low during power up. A broad power supply voltage range (2.7V-5.5V) is available, providing design flexibility.

## ●Features

- 1) Integrated expansion port function
- 2) Built-in RESET function
- 3) High speed output response characteristics
- 4) 3-line-type serial interface
- 5) Broad power supply voltage range: 2.7V-5.5V

## ●Applications

DVCs, DSCs, DVDs, CD-Rs, CD-RWs

## ●Line up matrix

Parameter	BH2226FV	BH2226F
Power source voltage range	2.7~5.5V	2.7~5.5V
Number of channels	8ch	8ch
Current consumption	1.3 mA	1.3 mA
Differential non linearity error	±1.0LSB	±1.0LSB
Integral non linearity error	±1.5LSB	±1.5LSB
Output current performance	±1.0mA	±1.0mA
Settling time	100μs	100μs
Data transfer frequency	10MHz	10MHz
Input format	CMOS	CMOS
Data latch method	CSB method	CSB method
Package	SSOP-B16	SOP16

## ● Absolute Maximum Ratings

(Ta=25°C)

Parameter	Symbol	Limits	Unit	Remarks
Power source voltage	VCC	-0.3~7.0	V	-
Terminal voltage	VIN	-0.3~VCC	V	-
Storage temperature range	TSTG	-55~125	°C	-
Power dissipation	PD	450 <sup>*1</sup>	mW	BH2226FV
		500 <sup>*2</sup>	mW	BH2226F

\*1 Derated at 4.5mW/ °C at Ta&gt;25°C

\*2 Derated at 5.0mW/ °C at Ta&gt;25°C

\*3 Please note that this product is not robust against radiation.

## ● Recommended Operating Conditions

(Ta=25°C)

Parameter	Symbol	Limits			Unit	Remarks
		MIN.	TYP.	MAX.		
VCC power source voltage	VCC	2.7	-	5.5	V	-
Terminal input voltage range	VIN	0	-	VCC	V	-
Analog output current	IO	-1.0	-	1.0	mA	-
Operating temperature range	TOPR	-20	-	85	°C	-
Serial clock frequency	FCLK	-	1.0	10.0	MHz	-
D/A output limit load capacity	CL	-	-	0.1	μF	-

## ● Electrical Characteristics

(Unless otherwise specified, VCC=3.0V, RL=OPEN, CL=0pF, Ta=25°C)

Parameter	Symbol	Limits			Unit	Conditions
		MIN.	TYP.	MAX.		
<Current consumption>						
VCC system	ICC	-	1.1	2.5	mA	CLK=1MHz, 80H setting
	ICCPD	-	5	20	μA	At power down setting
<Logic interface>						
L input voltage	VIL	GND	-	0.6	V	VCC=5V
H input voltage	VIH	2.4	-	VCC	V	VCC=5V
Input current	IIN	-10	-	10	μA	
L output voltage	VOL	-	-	0.4	V	IOH=2.5mA
H output voltage	VOH	VCC-0.4	-	-	V	IOL=0.4mA
<Buffer amplifier>						
Output zero scale voltage	ZS1	GND	-	0.1	V	00H setting, at no load
	ZS3	GND	-	0.3	V	00H setting, IOH=1.0mA
Output full scale voltage	FS1	VCC-0.1	-	VCC	V	FFH setting, at no load
	FS3	VCC-0.3	-	VCC	V	FFH setting, IOL=1.0mA
<D/A converter precision>						
Differential non linearity error	DNL	-1.0	-	1.0	LSB	Input code 02H~FDH
Integral non linearity error	INL	-1.5	-	1.5	LSB	Input code 02H~FDH
VCC power source voltage rise time	trVCC	100	-	-	μs	VCC=0→2.7V
Power on reset release voltage	VPOR	-	1.9	-	V	

● Timing Chart

(Unless otherwise specified, VCC=3.0V, RL=OPEN, CL=0pF, Ta=25°C)

Parameter	Symbol	Limits			Unit	Conditions
		MIN.	TYP.	MAX.		
CLK L level time	tCLKL	50	-	-	ns	
CLK H level time	tCLKH	50	-	-	ns	
DI setup time	tsDI	20	-	-	ns	
DI hold time	thDI	40	-	-	ns	
Parallel input setup time	tsPI	20	-	-	ns	
Parallel input hold time	thPI	40	-	-	ns	
CSB setup time	tsCSB	50	-	-	ns	
CSB hold time	thCSB	50	-	-	ns	
CSB H level time	tCSBH	50	-	-	ns	
D/A output settling time	tOUT	-	-	100	μs	CL=50pF, RL=10kΩ
Parallel output delay time	tpOUT	-	-	600	ns	CL=50pF, RL=10kΩ
Serial output delay time	tsOUT	-	-	350	ns	CL=50pF, RL=10kΩ

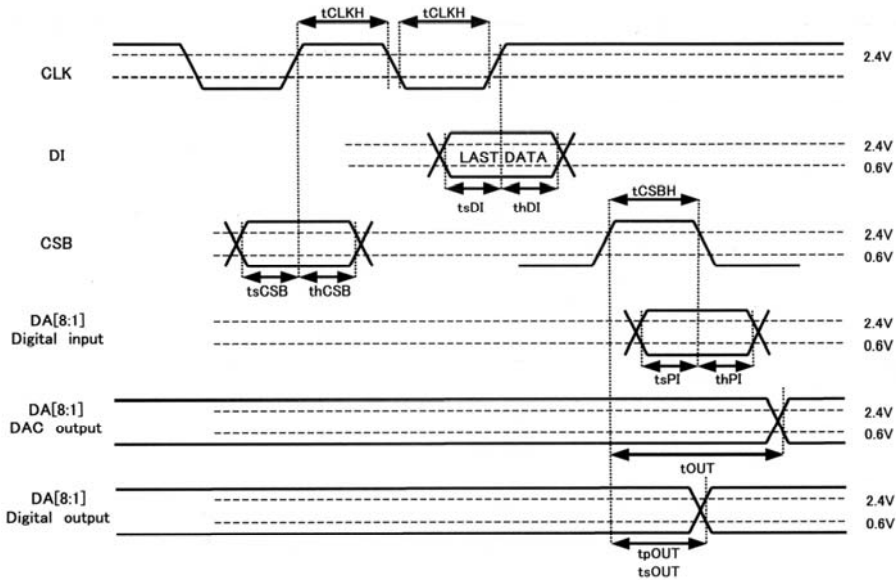

Fig.1

● Terminal Description / Block Diagrams

(BH2226FV, BH2226F)

No.	Terminal name	Function
1	DA1	Analog output terminal / I/O input output terminal
2	DA2	
3	DA3	
4	DA4	
5	DA5	
6	DA6	
7	DA7	
8	DA8	
9	VCC	Power source terminal
10	RESETB	Reset terminal
11	TEST	Test terminal (normal connected to GND)
12	CSB	Chip select signal input terminal
13	CLK	Serial clock input terminal
14	DI	Serial data input terminal
15	SO	Serial data output terminal
16	GND	Ground terminal

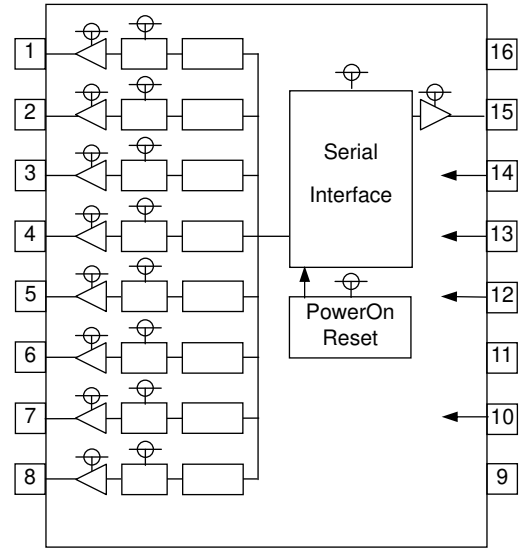

Fig.2

● Input-Output equivalence circuits

Terminal	Equivalence Circuit	Terminal	Equivalence Circuit
DA1 DA2 DA3 DA4 DA5 DA6 DA7 DA8		DI CLK CSB TEST RESETB	
		SO	

Fig.3 Input-Output equivalence circuits

● Operation Description

• Command Transmission

The Control command consists of 3 lines of 12bit serial input data (MSB first).

DI data is read at the rising edge of the CLK, and becomes valid in the CSB Low area (before the CSB rise for 12bit data).

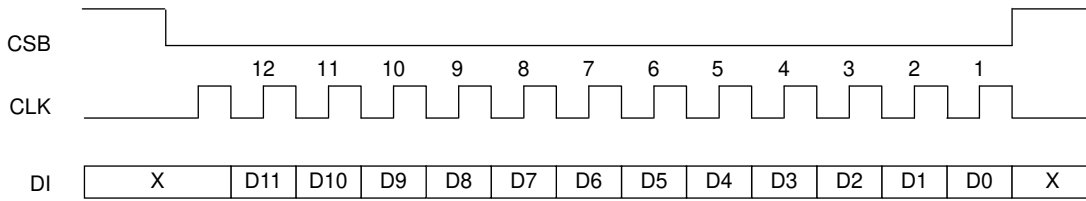

Fig.4

Data Settings

D0	D1	D2	D3	D4	D5	D6	D7	Setting
0	0	0	0	0	0	0	0	At D/A setting : GND
1	0	0	0	0	0	0	0	At D/A setting : (VCC-GND)/256x1
0	1	0	0	0	0	0	0	At D/A setting : (VCC-GND)/256 x 2
1	1	0	0	0	0	0	0	At D/A setting : (VCC-GND)/256 x 3
0	0	1	0	0	0	0	0	At D/A setting : (VCC-GND)/256 x 4
~								~
0	1	1	1	1	1	1	1	At D/A setting : (VCC-GND)/256 x 254
1	1	1	1	1	1	1	1	At D/A setting : (VCC-GND)/256 x 255

(Note) Default D[7:0]=00h

Channel Settings

D8	D9	D10	D11	Setting
0	0	0	0	Power down setting (default)
0	0	0	1	DA1
0	0	1	0	DA2
0	0	1	1	DA3
0	1	0	0	DA4
0	1	0	1	DA5
0	1	1	0	DA6
0	1	1	1	DA7
1	0	0	0	DA8
1	0	0	1	Power down release
1	0	1	0	Inconsequential
1	0	1	1	Inconsequential
1	1	0	0	I/O D/A select
1	1	0	1	I/O serial⇒Parallel
1	1	1	0	I/O parallel⇒Serial
1	1	1	1	I/O status setting

Input / Output D/A Selection settings : Each channel can be set for either I/O port or D/A converter output.

0: I/O mode (When I/O mode is selected, set the status as well.)

1: D/A mode (Set the I/O status to output mode.)

D0	D1	D2	D3	D4	D5	D6	D7	Description
DA1	DA2	DA3	DA4	DA5	DA6	DA7	DA8	Corresponding terminals for I/O or D/A selection

I/O Status Setting : Set the status of the I/O input output terminal by D0 ~ D7.

0: input mode (High-Z status)

1: output mode

D0	D1	D2	D3	D4	D5	D6	D7	Description
DA1	DA2	DA3	DA4	DA5	DA6	DA7	DA8	Corresponding terminals for status setting

• Command Transmission Procedures

Carry out the following after power on and just after external reset:

- (1) Power Down Release (2) I/O D/A Select (3) I/O Status Set

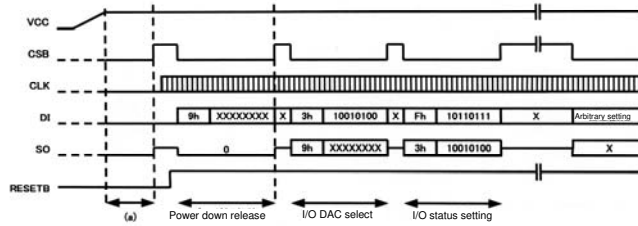

Fig.5

Note: When power is started, the power on reset is activated and the internal register initialized. However, as shown in the figure above, in area (a), if CSB cannot be made High and noise is introduced in the control line an error may occur when setting during the rising CSB signal.

In such a case, set the external RESETB terminal to Low and reset when CSB = High.

• Parallel - Serial Conversion

Parallel data {DA[8:1]} is taken in at the first CSB falling edge after setting the parallel serial command.

The data is then outputted in synch with the falling edge of the CLK in the next CSB = Low area, and output from 4CLK. However, please note that the SCLK falling edge that occurs from CSB fall to the first SCLK rising edge is not counted.

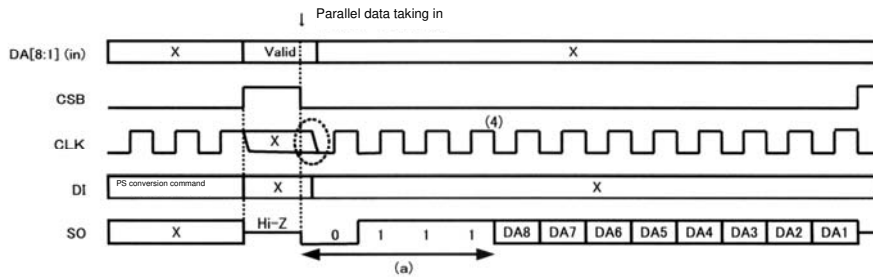

Fig.6

• Serial - Parallel Conversion

DI serial data is taken in at the rising edge of the CLK.

The data is then output from the DA[8:1] terminal just after the CSB rising edge.

During that time the SO terminal output becomes undetermined (just previous address setting + data output).

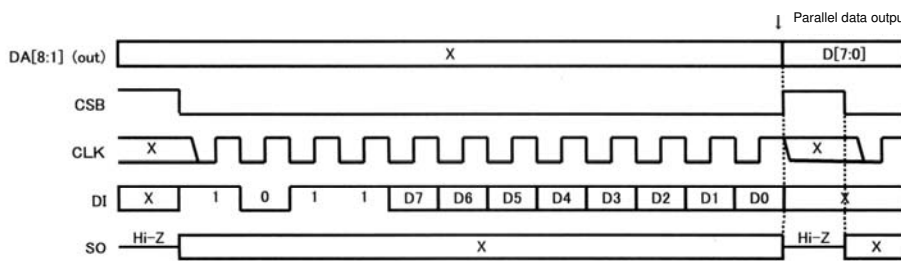

Fig.7

• D/A Converter Output Setting (Fig. 7)

DI serial data is taken in at the rising edge of the clock.

The D/A converter output is output from the DA[8:1] terminal just after the rising edge of the CSB.

During that time, the SO terminal output becomes undetermined (just previous address setting + data output).

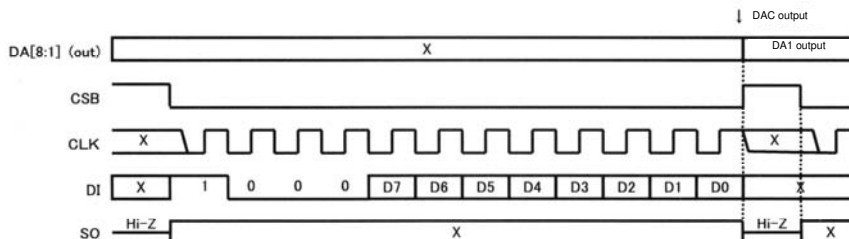

Fig.8

● Electrical Characteristics Curves

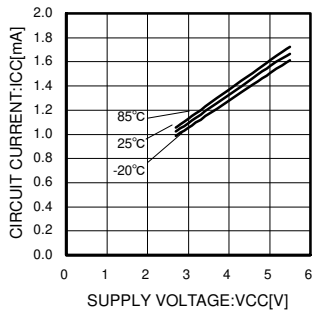

Fig.9 Action current consumption

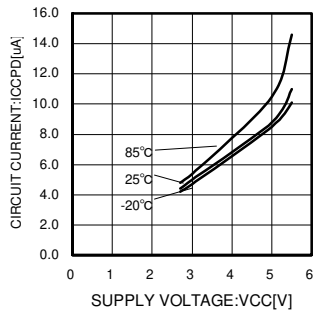

Fig.10 Consumption current at power down

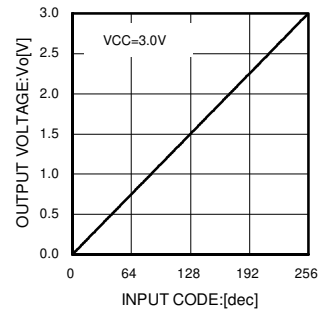

Fig.11 Output voltage characteristic

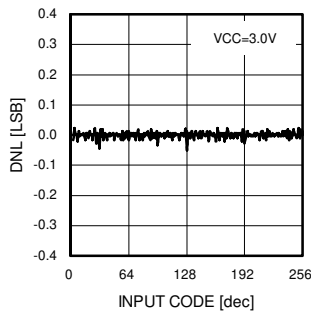

Fig.12 Differential non linearity error

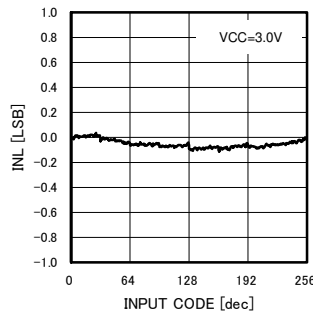

Fig.13 Integral non linearity error

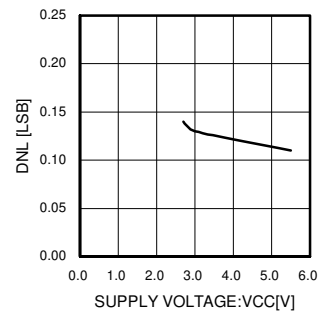

Fig.14 Power source voltage vs. differential non linearity error

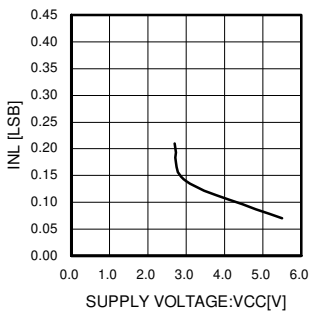

Fig.15 Power source voltage vs. integral non linearity error

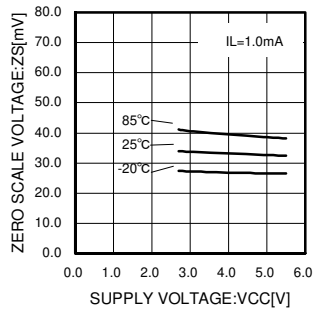

Fig.16 Output zero scale voltage

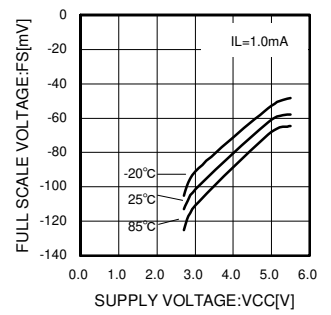

Fig.17 Output full scale voltage

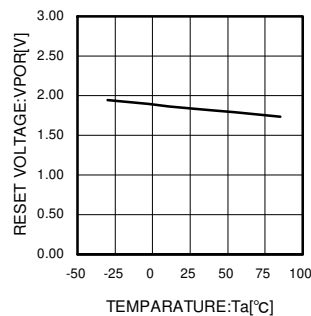

Fig.18 Reset release voltage

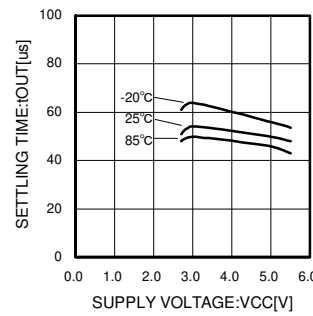

Fig.19 Settling time

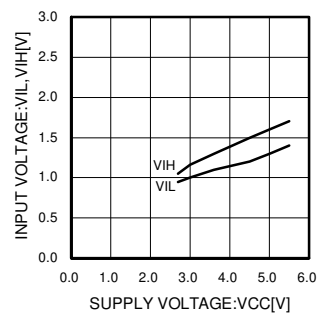

Fig.20 Input voltage



## ● Operation Notes

- (1) Numbers and data in entries are representative design values and are not guaranteed values of the items.
- (2) Although we are confident in recommending the sample application circuits, carefully check their characteristics further when using them. When modifying externally attached component constants before use, determine them so that they have sufficient margins by taking into account variations in externally attached components and the Rohm LSI, not only for static characteristics but also including transient characteristics.
- (3) Absolute Maximum Ratings  
Operating or testing the device over the maximum specifications may damage the part itself as well as peripheral components. Therefore, please ensure that the specifications are not exceeded.
- (4) GND potential  
Ensure that the GND terminal is at the lowest potential under all operating conditions.
- (5) Thermal design  
Use a thermal design that allows for a sufficient margin regarding power dissipation (Pd) under actual operating conditions.
- (6) Terminal shorts and mis-mounting  
Incorrect orientation or misalignment of the IC when mounting to the PCB may damage part. Short-circuits caused by the introduction of foreign matter between the output terminals or across the output and power supply or GND may also result in destruction.
- (7) Operation in a strong magnetic field  
Operation in a strong electromagnetic field may cause malfunction.
- (8) Reset Function  
The power on reset circuit, which initializes internal settings, may malfunction during abrupt power ons. Therefore, set the time constant so as to satisfy the power source rise time.
- (9) After power on and after the external reset is in power down status, DA1 ~ DA8 will be in input mode (all terminals at High-Z).
- (10) In the case of condition changes in the DA1 ~ DA8 terminals (i.e. changes from D/A mode to serial-parallel mode, from serial-parallel mode to parallel-serial mode, excluding D/A data and I/O data updates), change both analog and digital settings of High-Z.
- (11) Connect the RESETB terminal to VCC and set it to High, making sure that it becomes Low only at reset.
- (12) Initialization of the serial interface shift register is carried out only by power on reset, or external reset, and is not reset by CSB = High. Therefore, when a specified clock number (12CLK) is not attained during command setting, interrupting processing, transfer regular data once again.
- (13) The power down function restricts the consumption current in the internal analog circuit. Set it by command. At power down, for channels set to D/A mode, "I/O D/A selection" is changed from "D/A mode" to "I/O mode". Therefore, when the "I/O status setting" of the channel is in input mode, the terminal is in High-Z status and the input becomes unstable and unnecessary current flows. Set the I/O status setting of channel to be in output mode, or set the terminal using resistance.
- (14) When shifting from PIO use status to D/A use status, a wait time in order to ensure D/A output stability is necessary. Therefore wait for a maximum of 1ms after the "I/O D/A select" command is input.  
If wait time is problematic, set the D/A setting code to 80hex and change it to the specified code setting.

● Ordering part number

B	H
---	---

Part No.

2	2	2	6
---	---	---	---

Part No.

F	V
---	---

Package  
 FV: SSOP-B16  
 F: SOP16

E	2
---	---

Packaging and forming specification  
 E2: Embossed tape and reel  
 (SSOP-B16/SOP16)

SOP16

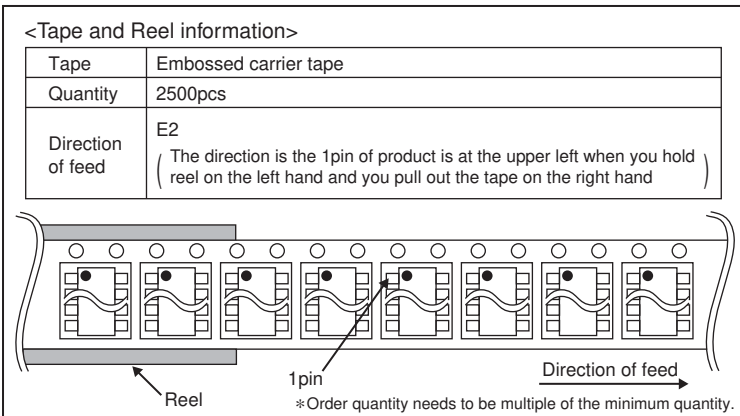
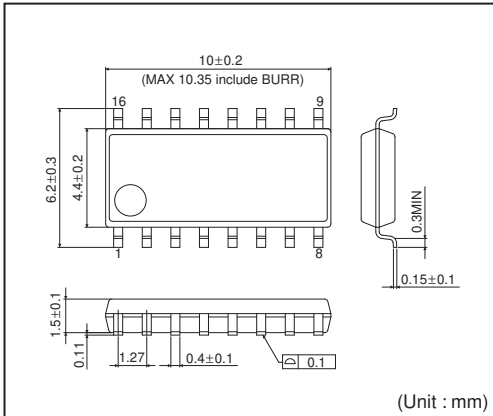

SSOP-B16

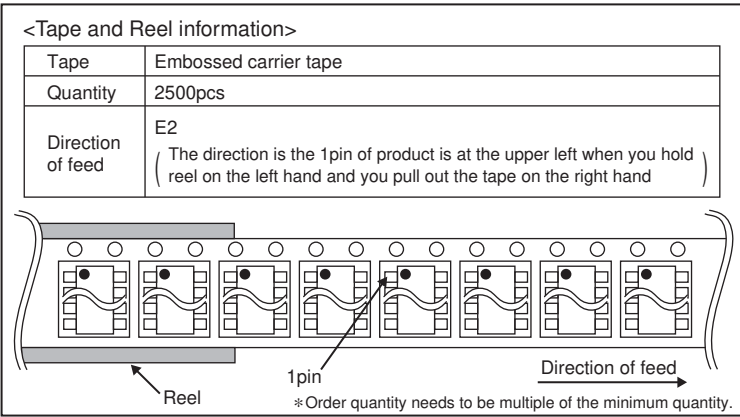
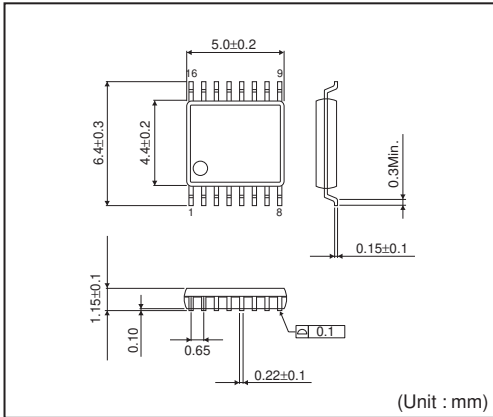

## Notes

No copying or reproduction of this document, in part or in whole, is permitted without the consent of ROHM Co.,Ltd.

The content specified herein is subject to change for improvement without notice.

The content specified herein is for the purpose of introducing ROHM's products (hereinafter "Products"). If you wish to use any such Product, please be sure to refer to the specifications, which can be obtained from ROHM upon request.

Examples of application circuits, circuit constants and any other information contained herein illustrate the standard usage and operations of the Products. The peripheral conditions must be taken into account when designing circuits for mass production.

Great care was taken in ensuring the accuracy of the information specified in this document. However, should you incur any damage arising from any inaccuracy or misprint of such information, ROHM shall bear no responsibility for such damage.

The technical information specified herein is intended only to show the typical functions of and examples of application circuits for the Products. ROHM does not grant you, explicitly or implicitly, any license to use or exercise intellectual property or other rights held by ROHM and other parties. ROHM shall bear no responsibility whatsoever for any dispute arising from the use of such technical information.

The Products specified in this document are intended to be used with general-use electronic equipment or devices (such as audio visual equipment, office-automation equipment, communication devices, electronic appliances and amusement devices).

The Products specified in this document are not designed to be radiation tolerant.

While ROHM always makes efforts to enhance the quality and reliability of its Products, a Product may fail or malfunction for a variety of reasons.

Please be sure to implement in your equipment using the Products safety measures to guard against the possibility of physical injury, fire or any other damage caused in the event of the failure of any Product, such as derating, redundancy, fire control and fail-safe designs. ROHM shall bear no responsibility whatsoever for your use of any Product outside of the prescribed scope or not in accordance with the instruction manual.

The Products are not designed or manufactured to be used with any equipment, device or system which requires an extremely high level of reliability the failure or malfunction of which may result in a direct threat to human life or create a risk of human injury (such as a medical instrument, transportation equipment, aerospace machinery, nuclear-reactor controller, fuel-controller or other safety device). ROHM shall bear no responsibility in any way for use of any of the Products for the above special purposes. If a Product is intended to be used for any such special purpose, please contact a ROHM sales representative before purchasing.

If you intend to export or ship overseas any Product or technology specified herein that may be controlled under the Foreign Exchange and the Foreign Trade Law, you will be required to obtain a license or permit under the Law.



Thank you for your accessing to ROHM product informations.  
More detail product informations and catalogs are available, please contact us.

## ROHM Customer Support System

<http://www.rohm.com/contact/>