

Chipsmall Limited consists of a professional team with an average of over 10 year of expertise in the distribution of electronic components. Based in Hongkong, we have already established firm and mutual-benefit business relationships with customers from,Europe,America and south Asia,supplying obsolete and hard-to-find components to meet their specific needs.

With the principle of “Quality Parts,Customers Priority,Honest Operation,and Considerate Service”,our business mainly focus on the distribution of electronic components. Line cards we deal with include Microchip,ALPS,ROHM,Xilinx,Pulse,ON,Everlight and Freescale. Main products comprise IC,Modules,Potentiometer,IC Socket,Relay,Connector.Our parts cover such applications as commercial,industrial, and automotives areas.

We are looking forward to setting up business relationship with you and hope to provide you with the best service and solution. Let us make a better world for our industry!



Contact us

Tel: +86-755-8981 8866 Fax: +86-755-8427 6832

Email & Skype: info@chipsmall.com Web: www.chipsmall.com

Address: A1208, Overseas Decoration Building, #122 Zhenhua RD., Futian, Shenzhen, China

RED IS ORIGINAL

DISK # H 4 DWS SIZE C
 DATA CONTAINED IN THIS DOCUMENT IS PROPRIETARY TO TROMPETER & STRICKLER INC. AND SHALL NOT BE DISCLOSED, COPIED OR USED FOR REPRODUCTION OR MANUFACTURE WITHOUT EXPRESS WRITTEN PERMISSION.

REV		EO	DESCRIPTION	DWN	APPROVED	DATE
F	10049		PICTORIALLY CHANGED TO FLARED SEALING SLEEVE TO STRAIGHT (1.25) LONG SEALING SLEEVE; GENERAL UPDATE	DKC	<i>DKC</i>	12/15/92

DASH NO	MODEL NO	CENTER CONTACT/INTMD CONTACT TYPE	FIG NO
-1	BJ459ACFLP	SOCKET/PIN	1
-2	BJ459ACFLS	PIN/SOCKET	1
-3	BJ459ACPP	SOCKET/PIN	2
-4	BJ459ACPS	PIN/SOCKET	2
-5	BJ459ACRP	SOCKET/PIN	3
-6	BJ459ACRS	PIN/SOCKET	3
-7	BJ459ACWP	SOCKET/PIN	4
-8	BJ459ACWS	PIN/SOCKET	4

CABLE GROUP NO	CABLES ACCOMMODATED	A DIM	B DIA	C HEX	ASSEMBLE PER
-201	M17/176-00002				
-202	TWC-78-1, TROMPETER				
-203	TWC-124-1A, TROMPETER				
-204	10802 RAYCHEM				
-205	TWC-78-1F2, TROMPETER				
-206	782600130, RAYCHEM				
-208	202-3927, MICRODOT				
-209	202-3942, MICRODOT				
-212	2524E0114, RAYCHEM	1.365	.334	.255	TAI-162
-217	0C875M24H GRUMMAN				
-218	EPD221888, RAYCHEM				
-219	2526D1114, RAYCHEM				
-220	0C875HR1 GRUMMAN				
-221	10614, RAYCHEM				
-222	10613, RAYCHEM				
-223	HMS2-1149, HUGHES				

INCH	MM
.003	0.08
.0050	0.13
.010	0.25
.030	0.76
.047	1.19
.071	1.80
.156	3.96
.2400	6.10
.255	6.48
.274	6.96
.278	7.05
.330	8.38
.334	8.48
.335	8.51
.43	10.92
.4375	11.11
.707	17.96
1.25	31.75
1.365	34.67

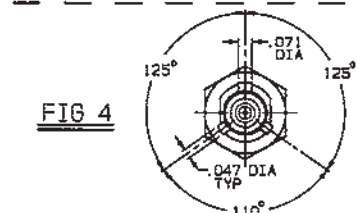
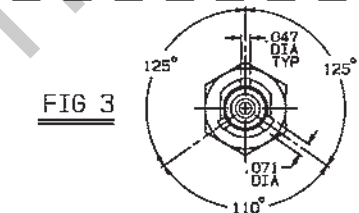
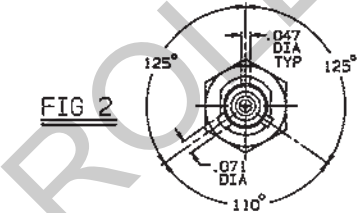
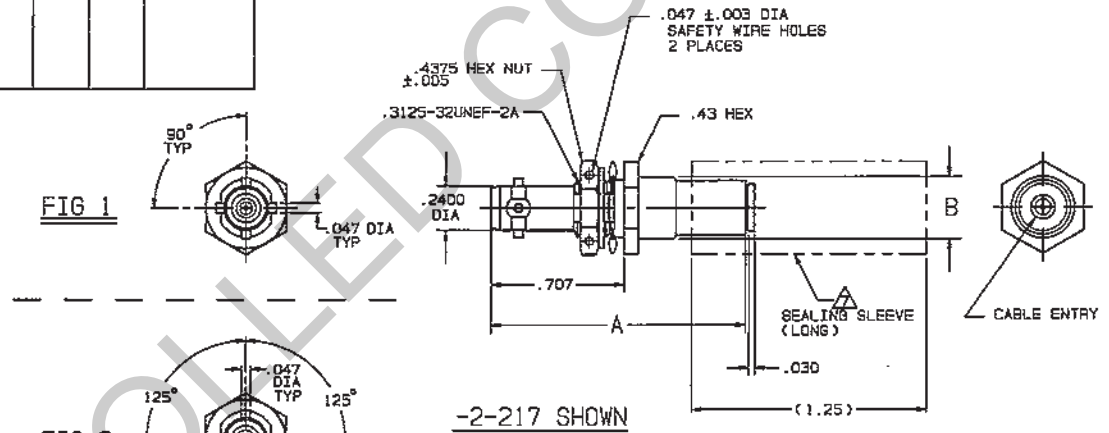

▲ SEALING SLEEVE & CRIMP BUSHING LOOSE WITH EACH CONNECTOR EXCEPT NOT USED ON -205, -208 & -223

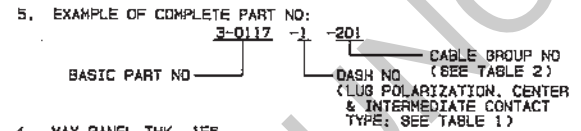
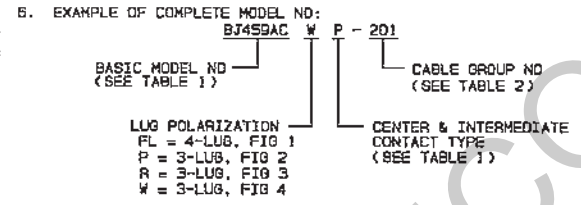

- MAX PANEL THK .156
- CONCENTRIC TWINAX 4 PIECE ASSY, FULL CRIMP NONINSULATED BULKHEAD MOUNT RECEPTACLE, SOCKET CONTACT AND PIN INTERMEDIATE CONTACT OR PIN CENTER CONTACT AND SOCKET INTERMEDIATE CONTACT
- FINISH: TFS-1U (500 HOURS SALT SPRAY; NICKEL)
- ALL DIM ARE IN INCHES

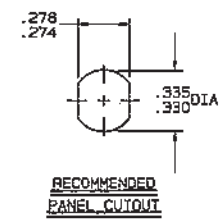

QTY	DESCRIPTION	PART NUMBER	ITEM
TOL UNLESS SPECIFIED			
.XX ± .03			
.XXX ± .010			
.XXXX ± .0050			
ANGLE: 0°-30°			
DWN DKC 12-2-92	MATERIAL	CODE IDENT	DRAWING NO.
CHK <i>DKC</i> 12/9/92		14949	3-0117
ENGR			REV F
NEXT ASSY	APPR <i>DKC</i> 12/15/92	SCALE 2/1	DATE 5-20-87
			SHEET 1 OF 2