



Chipsmall Limited consists of a professional team with an average of over 10 year of expertise in the distribution of electronic components. Based in Hongkong, we have already established firm and mutual-benefit business relationships with customers from,Europe,America and south Asia,supplying obsolete and hard-to-find components to meet their specific needs.

With the principle of "Quality Parts,Customers Priority,Honest Operation,and Considerate Service",our business mainly focus on the distribution of electronic components. Line cards we deal with include Microchip,ALPS,ROHM,Xilinx,Pulse,ON,Everlight and Freescale. Main products comprise IC,Modules,Potentiometer,IC Socket,Relay,Connector.Our parts cover such applications as commercial,industrial, and automotives areas.

We are looking forward to setting up business relationship with you and hope to provide you with the best service and solution. Let us make a better world for our industry!



Contact us

Tel: +86-755-8981 8866 Fax: +86-755-8427 6832

Email & Skype: info@chipsmall.com Web: www.chipsmall.com

Address: A1208, Overseas Decoration Building, #122 Zhenhua RD., Futian, Shenzhen, China



BLC9G15XS-400AVT

Power LDMOS transistor

Rev. 1 — 24 November 2017

AMPLEON

Product data sheet

1. Product profile

1.1 General description

400 W LDMOS packaged asymmetric Doherty power transistor for base station applications at frequencies from 1452 MHz to 1511 MHz.

Table 1. Typical performance

Typical RF performance at $T_{case} = 25\text{ °C}$ in an asymmetrical Doherty production test circuit.

$V_{DS} = 32\text{ V}$; $I_{Dq} = 810\text{ mA}$ (main); $V_{GS(amp)peak} = 0.5\text{ V}$, unless otherwise specified.

Test signal	f	V_{DS}	$P_{L(AV)}$	G_p	η_D	ACPR
	(MHz)	(V)	(W)	(dB)	(%)	(dBc)
1-carrier W-CDMA	1452 to 1511	32	93	16	47.6	-34 [1]

[1] Test signal: 1-carrier W-CDMA; 3GPP test model 1; 64 DPCH; PAR = 9.6 dB at 0.01 % probability on CCDF.

1.2 Features and benefits

- Excellent ruggedness
- High efficiency
- Low thermal resistance providing excellent thermal stability
- Lower output capacitance for improved performance in Doherty applications
- Designed for low memory effects providing excellent digital pre-distortion capability
- Internally matched for ease of use
- Integrated ESD protection
- Compliant to Directive 2002/95/EC, regarding Restriction of Hazardous Substances (RoHS)

1.3 Applications

- RF power amplifiers for base stations and multi carrier applications in the 1452 MHz to 1511 MHz frequency range

2. Pinning information

Table 2. Pinning

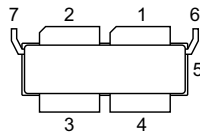
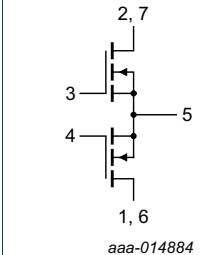
Pin	Description	Simplified outline	Graphic symbol
1	drain2 (peak)		
2	drain1 (main)		
3	gate1 (main)		
4	gate2 (peak)		
5	source [1]		
6	video decoupling (peak)		
7	video decoupling (main)		

[1] Connected to flange.

3. Ordering information

Table 3. Ordering information

Type number	Package		
	Name	Description	Version
BLC9G15XS-400AVT	-	air cavity plastic earless flanged package; 6 leads	SOT1258-4

4. Limiting values

Table 4. Limiting values

In accordance with the Absolute Maximum Rating System (IEC 60134).

Symbol	Parameter	Conditions	Min	Max	Unit
V_{DS}	drain-source voltage		-	65	V
$V_{GS(amp)main}$	main amplifier gate-source voltage		-6	+13	V
$V_{GS(amp)peak}$	peak amplifier gate-source voltage		-6	+13	V
T_{stg}	storage temperature		-65	+150	°C
T_j	junction temperature		[1]	225	°C
T_{case}	case temperature	operating	[1]	+125	°C

[1] Continuous use at maximum temperature will affect the reliability, for details refer to the online MTF calculator.

5. Thermal characteristics

Table 5. Thermal characteristics

Symbol	Parameter	Conditions	Typ	Unit
$R_{th(j-c)}$	thermal resistance from junction to case	$V_{DS} = 32\text{ V}; I_{Dq} = 980\text{ mA (main)};$ $V_{GS(amp)peak} = 0,4\text{ V}; T_{case} = 80\text{ °C}$		
		$P_L = 93\text{ W}$	0.28	k/W
		$P_L = 117\text{ W}$	0.26	k/W

6. Characteristics

Table 6. DC characteristics

$T_j = 25\text{ °C}$ unless otherwise specified.

Symbol	Parameter	Conditions	Min	Typ	Max	Unit
Main device						
$V_{(BR)DSS}$	drain-source breakdown voltage	$V_{GS} = 0\text{ V}; I_D = 1.62\text{ mA}$	65	-	-	V
$V_{GS(th)}$	gate-source threshold voltage	$V_{DS} = 10\text{ V}; I_D = 162\text{ mA}$	1.5	2.0	2.5	V
V_{GSq}	gate-source quiescent voltage	$V_{DS} = 32\text{ V}; I_D = 810\text{ mA}$	1.65	2.15	2.65	V
I_{DSS}	drain leakage current	$V_{GS} = 0\text{ V}; V_{DS} = 32\text{ V}$	-	-	2.8	μA
I_{DSX}	drain cut-off current	$V_{GS} = V_{GS(th)} + 3.75\text{ V}$	-	32	-	A
I_{GSS}	gate leakage current	$V_{GS} = 11\text{ V}; V_{DS} = 0\text{ V}$	-	-	280	nA
g_{fs}	forward transconductance	$V_{DS} = 10\text{ V}; I_D = 8.1\text{ A}$	-	10.8	-	S
$R_{DS(on)}$	drain-source on-state resistance	$V_{GS} = V_{GS(th)} + 3.75\text{ V}; I_D = 5.67\text{ A}$	-	89	149	$\text{m}\Omega$
Peak device						
$V_{(BR)DSS}$	drain-source breakdown voltage	$V_{GS} = 0\text{ V}; I_D = 3.0\text{ mA}$	65	-	-	V
$V_{GS(th)}$	gate-source threshold voltage	$V_{DS} = 20\text{ V}; I_D = 300\text{ mA}$	1.5	2.0	2.5	V
V_{GSq}	gate-source quiescent voltage	$V_{DS} = 32\text{ V}; I_D = 1500\text{ mA}$	1.65	2.15	2.65	V
I_{DSS}	drain leakage current	$V_{GS} = 0\text{ V}; V_{DS} = 32\text{ V}$	-	-	2.8	μA
I_{DSX}	drain cut-off current	$V_{GS} = V_{GS(th)} + 3.75\text{ V}$	-	58	-	A
I_{GSS}	gate leakage current	$V_{GS} = 11\text{ V}; V_{DS} = 0\text{ V}$	-	-	280	nA
g_{fs}	forward transconductance	$V_{DS} = 20\text{ V}; I_D = 15\text{ A}$	-	17.6	-	S
$R_{DS(on)}$	drain-source on-state resistance	$V_{GS} = V_{GS(th)} + 3.75\text{ V}; I_D = 10.5\text{ A}$	-	55	85	$\text{m}\Omega$

Table 7. RF characteristics

Test signal: 1-carrier W-CDMA; PAR = 9.6 dB at 0.01 % probability on the CCDF; 3GPP test model 1; 1 to 64 DPCH; $f_1 = 1455\text{ MHz}; f_2 = 1508.5\text{ MHz}$; RF performance at $V_{DS} = 32\text{ V}; I_{Dq} = 810\text{ mA}$ (main); $V_{GS(amp)peak} = 0.5\text{ V}; T_{case} = 25\text{ °C}$; unless otherwise specified; in an asymmetrical Doherty production test circuit at frequencies from 1452 MHz to 1511 MHz.

Symbol	Parameter	Conditions	Min	Typ	Max	Unit
G_p	power gain	$P_{L(AV)} = 93\text{ W}$	14.8	16	-	dB
RL_{in}	input return loss	$P_{L(AV)} = 93\text{ W}$	-	-14	-10	dB
η_D	drain efficiency	$P_{L(AV)} = 93\text{ W}$	44	47.6	-	%
ACPR	adjacent channel power ratio	$P_{L(AV)} = 93\text{ W}$	-	-34	-29	dBc

Table 8. RF characteristics

Test signal: 1-carrier W-CDMA; PAR = 9.6 dB at 0.01 % probability on the CCDF; 3GPP test model 1; 1 to 64 DPCH; $f = 1508.5\text{ MHz}$; RF performance at $V_{DS} = 32\text{ V}; I_{Dq} = 810\text{ mA}$ (main); $V_{GS(amp)peak} = 0.5\text{ V}; T_{case} = 25\text{ °C}$; unless otherwise specified; in an asymmetrical Doherty production test circuit at a frequency of 1511 MHz.

Symbol	Parameter	Conditions	Min	Typ	Max	Unit
PAR_O	output peak-to-average ratio	$P_{L(AV)} = 110\text{ W}$	6.1	6.7	-	dB
$P_{L(M)}$	peak output power	$P_{L(AV)} = 110\text{ W}$	439	510	-	W

7. Test information

7.1 Ruggedness in Doherty operation

The BLC9G15XS-400AVT is capable of withstanding a load mismatch corresponding to VSWR = 10 : 1 through all phases under the following conditions: $V_{DS} = 32\text{ V}$; $I_{Dq} = 810\text{ mA}$; $V_{GS(amp)peak} = 0.5\text{ V}$; $f = 1454.5\text{ MHz}$; $P_L = 126\text{ W}$ (5 dB OBO); 1-carrier W-CDMA; 100 % clipping.

7.2 Impedance information

Table 9. Typical impedance of main device

Measured load-pull data of main device; $I_{Dq} = 810\text{ mA}$ (main); $V_{DS} = 32\text{ V}$; pulsed CW ($t_p = 100\text{ }\mu\text{s}$; $\delta = 10\%$).

f	Z _S [1]	Z _L [1]	P _L [2]	η_D [2]	G _p [2]
(MHz)	(Ω)	(Ω)	(W)	(%)	(dB)
Maximum power load					
1440	1.0 – j4.0	1.3 – j3.0	306.3	66.3	17.1
1480	1.5 – j3.9	1.3 – j3.4	292.8	64.2	17.0
1510	1.3 – j4.3	1.4 – j3.2	296.7	66.4	17.4
Maximum drain efficiency load					
1440	1.0 – j4.0	2.9 – j3.1	202.0	72.2	19.5
1480	1.5 – j3.9	2.2 – j3.0	237.3	72.3	18.7
1510	1.3 – j4.3	2.6 – j2.8	203.3	72.1	19.5

[1] Z_S and Z_L defined in [Figure 1](#).

[2] At 3 dB gain compression.

Table 10. Typical impedance of peak device

Measured load-pull data of peak device; $I_{Dq} = 1500\text{ mA}$ (peak); $V_{DS} = 32\text{ V}$; pulsed CW ($t_p = 100\text{ }\mu\text{s}$; $\delta = 10\%$).

f	Z _S [1]	Z _L [1]	P _L [2]	η_D [2]	G _p [2]
(MHz)	(Ω)	(Ω)	(W)	(%)	(dB)
Maximum power load					
1440	1.6 – j6.3	2.0 – j2.9	458.2	60.6	17.1
1480	2.3 – j7.3	1.9 – j2.9	468.7	60.3	16.9
1510	2.5 – j7.9	1.8 – j2.7	471.8	59.9	17.1
Maximum drain efficiency load					
1440	1.6 – j6.3	3.9 – j2.2	335.8	66.6	18.9
1480	2.3 – j7.3	3.2 – j2.2	386.3	67.0	18.4
1510	2.5 – j7.9	3.1 – j1.5	347.9	67.3	19.1

[1] Z_S and Z_L defined in [Figure 1](#).

[2] At 3 dB gain compression.

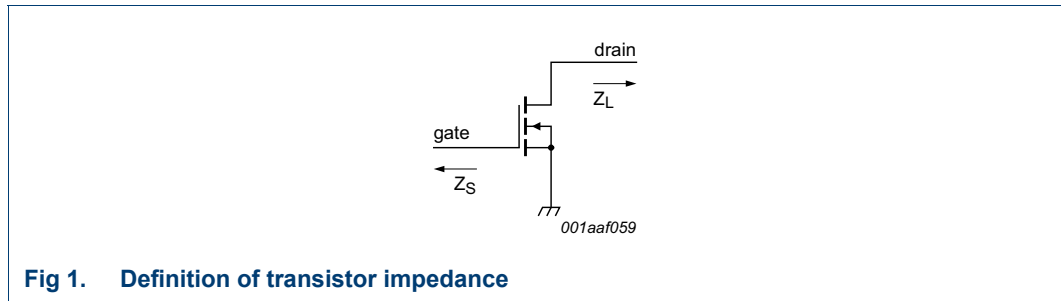

7.3 Recommended impedances for Doherty design

Table 11. Typical impedance of main at 1 : 1 load

Measured load-pull data of main device; $I_{Dq} = 810 \text{ mA (main)}$; $V_{DS} = 32 \text{ V}$; pulsed CW ($t_p = 100 \mu\text{s}$; $\delta = 10 \%$).

f (MHz)	Z_S [1] (Ω)	Z_L [1] (Ω)	$P_{L(3dB)}$ [2] (W)	η_D [3] (%)	G_p [3] (dB)
1440	1.0 – j4.0	1.5 – j3.4	283.8	42.2	20.6
1480	1.5 – j3.9	1.5 – j3.1	288.4	42.0	20.5
1510	1.3 – j4.3	1.5 – j2.9	284.4	42.2	20.7

[1] Z_S and Z_L defined in [Figure 1](#).

[2] At 3 dB compression.

[3] At $P_{L(AV)} = 93 \text{ W}$.

Table 12. Typical impedance of main device at 1 : 2.5 load

Measured load-pull data of main device; $I_{Dq} = 810 \text{ mA (main)}$; $V_{DS} = 32 \text{ V}$; pulsed CW ($t_p = 100 \mu\text{s}$; $\delta = 10 \%$).

f (MHz)	Z_S [1] (Ω)	Z_L [1] (Ω)	$P_{L(3dB)}$ [2] (W)	η_D [3] (%)	G_p [3] (dB)
1440	1.0 – j4.0	3.6 – j2.5	158.5	60.4	23.0
1480	1.5 – j3.9	3.6 – j2.4	156.0	61.2	23.0
1510	1.3 – j4.3	3.6 – j2.3	152.4	61.5	23.4

[1] Z_S and Z_L defined in [Figure 1](#).

[2] At 3 dB compression.

[3] At $P_{L(AV)} = 93 \text{ W}$.

Table 13. Typical impedance of peak device at 1 : 1 load

Measured load-pull data of peak device; $I_{Dq} = 1500 \text{ mA (peak)}$; $V_{DS} = 32 \text{ V}$; pulsed CW ($t_p = 100 \mu\text{s}$; $\delta = 10 \%$).

f	Z _S [1]	Z _L [1]	P _{L(3dB)} [2]	η _D [3]	G _p [3]
(MHz)	(Ω)	(Ω)	(W)	(%)	(dB)
1440	1.6 – j6.3	2.2 – j3.1	443.6	30.4	20.3
1480	2.3 – j7.3	2.2 – j2.7	451.9	30.9	20.5
1510	2.5 – j7.9	2.2 – j2.4	445.7	31.9	20.9

[1] Z_S and Z_L defined in [Figure 1](#).

[2] At 3 dB compression.

[3] At P_{L(AV)} = 93 W.

Table 14. Off-state impedances of peak device

f	Z _{off}
(MHz)	(Ω)
1440	1.4 – j4.3
1480	0.7 – j2.7
1510	0.5 – j1.9

7.4 Test circuit

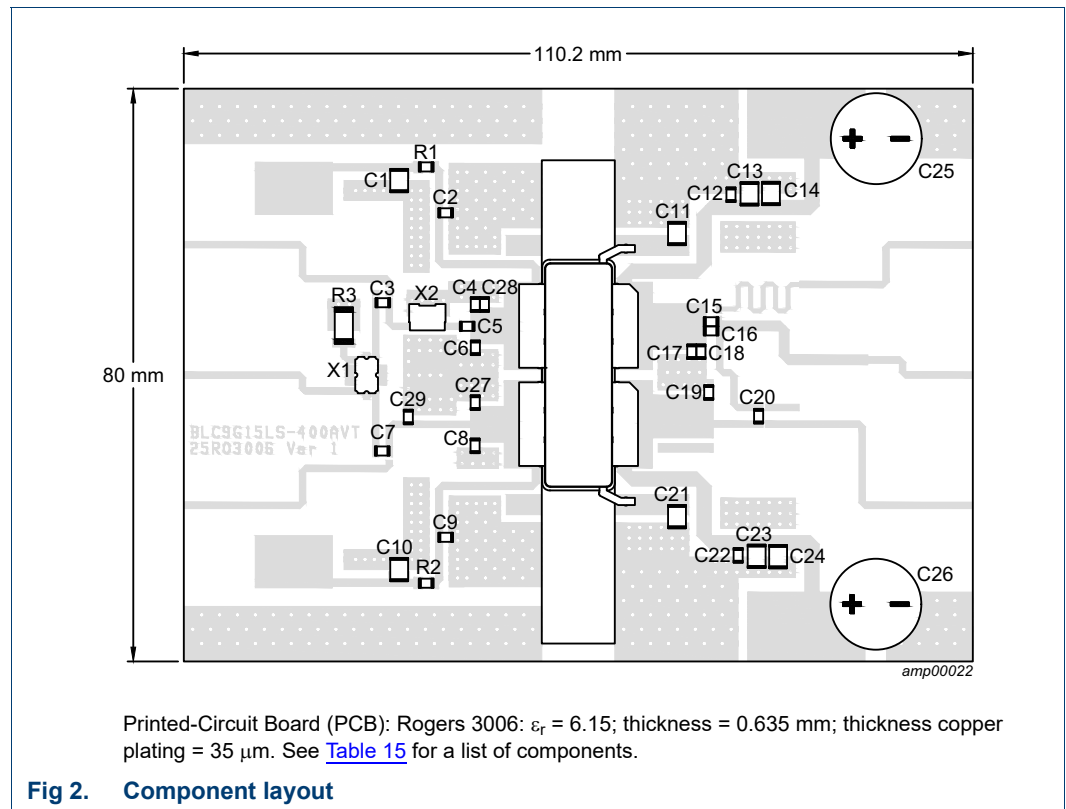

Table 15. List of components

See [Figure 2](#) for component layout.

Component	Description	Value	Remarks
C1, C10, C11, C13, C14, C21, C23, C24	multilayer ceramic chip capacitor	4.7 μ F	Murata GRM32ER71H475KA88L
C2, C3, C5, C7, C9, C12, C15, C16, C20, C22	multilayer ceramic chip capacitor	18 pF	Murata Hi-Q 0805
C4, C6, C27, C28	multilayer ceramic chip capacitor	2.0 pF	Murata Hi-Q 0805
C8, C17, C18	multilayer ceramic chip capacitor	1.8 pF	Murata Hi-Q 0805
C19	multilayer ceramic chip capacitor	2.7 pF	Murata Hi-Q 0805
C25, C26	electrolytic capacitor	470 μ F	63 V
C29	multilayer ceramic chip capacitor	0.3 pF	ATC 100A 0805
R1, R2	SMD resistor	4.7 Ω , 1 %	0805
R3	SMD resistor	50 Ω , 25 W	Anaren C16A50Z4
X1	hybrid coupler	2 dB, 90°	Anaren X3C20F1-02S
X2	attenuator	1 dB	Anaren D10AAXXZ4

7.5 Graphical data

7.5.1 Pulsed CW

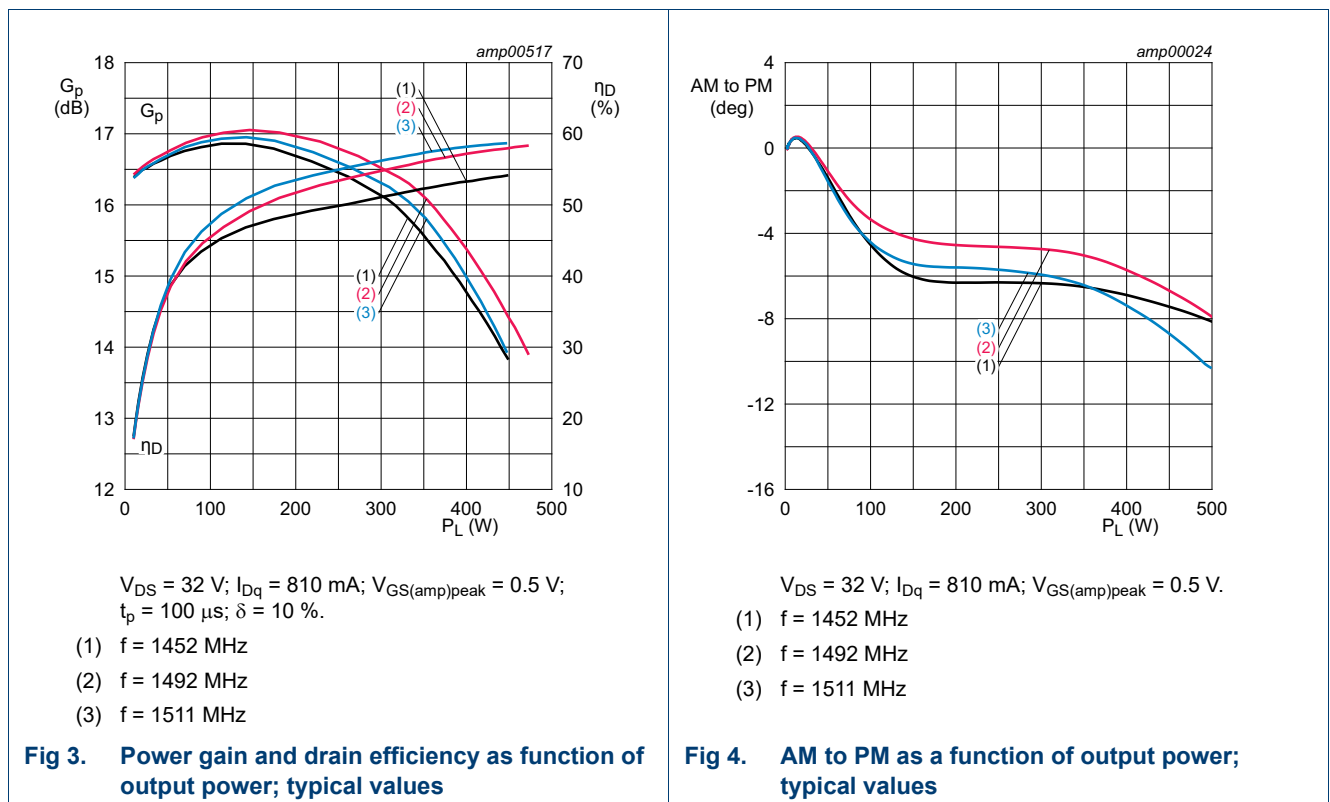

7.5.2 1-Carrier W-CDMA

PAR = 9.6 dB per carrier at 0.01 % probability on the CCDF; 3GPP test model 1 with 64 DPCH (100 % clipping).

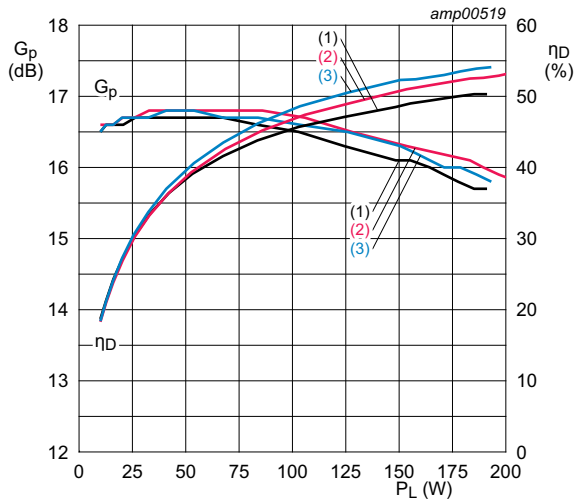

$V_{DS} = 32\text{ V}; I_{Dq} = 810\text{ mA}; V_{GS(amp)peak} = 0.5\text{ V}.$

- (1) $f = 1454.5\text{ MHz}$
- (2) $f = 1489.5\text{ MHz}$
- (3) $f = 1508.5\text{ MHz}$

Fig 5. Power gain and drain efficiency as function of output power; typical values

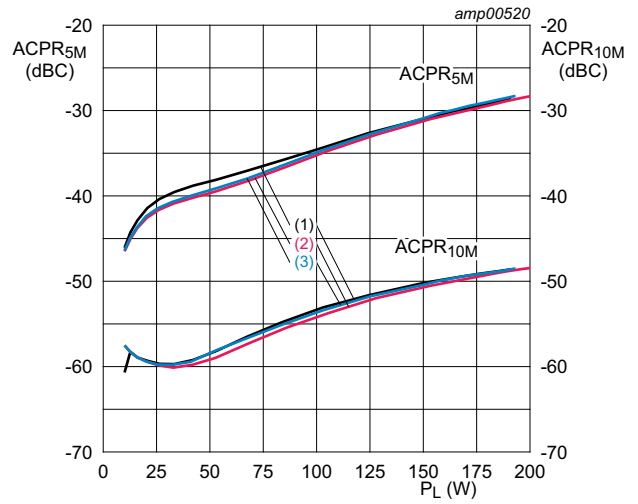

$V_{DS} = 32\text{ V}; I_{Dq} = 810\text{ mA}; V_{GS(amp)peak} = 0.5\text{ V}.$

- (1) $f = 1454.5\text{ MHz}$
- (2) $f = 1489.5\text{ MHz}$
- (3) $f = 1508.5\text{ MHz}$

Fig 6. Adjacent channel power ratio (5 MHz) and adjacent channel power ratio (10 MHz) as function of output power; typical values

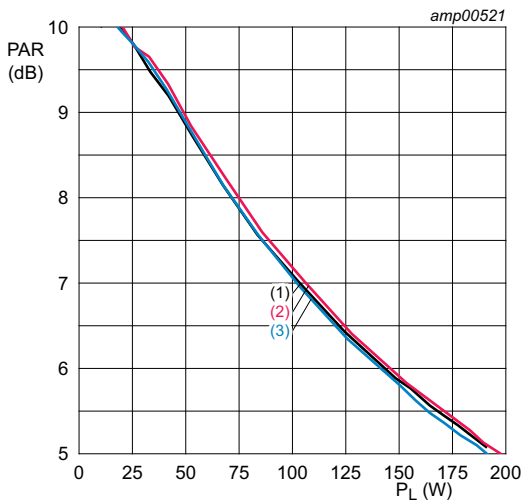

$V_{DS} = 32\text{ V}; I_{Dq} = 810\text{ mA}; V_{GS(amp)peak} = 0.5\text{ V}.$

- (1) $f = 1454.5\text{ MHz}$
- (2) $f = 1489.5\text{ MHz}$
- (3) $f = 1508.5\text{ MHz}$

Fig 7. Peak-to-average power ratio as a function of output power; typical values

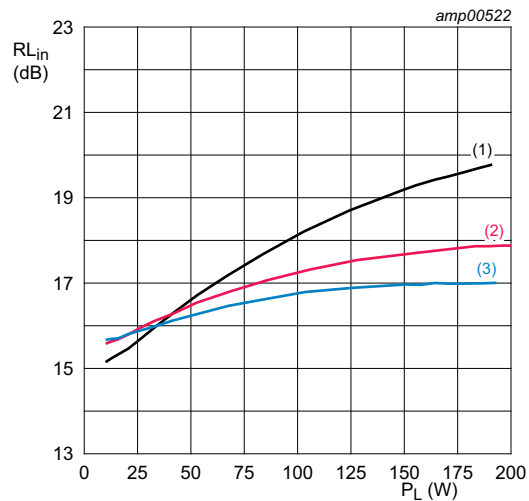

$V_{DS} = 32\text{ V}; I_{Dq} = 810\text{ mA}; V_{GS(amp)peak} = 0.5\text{ V}.$

- (1) $f = 1454.5\text{ MHz}$
- (2) $f = 1489.5\text{ MHz}$
- (3) $f = 1508.5\text{ MHz}$

Fig 8. Input return loss as a function of output power; typical values

7.5.3 2-Carrier W-CDMA

PAR = 9.6 dB at 0.01 % probability on the CCDF; 3GPP test model 1 with 64 DPCH (46 % clipping).

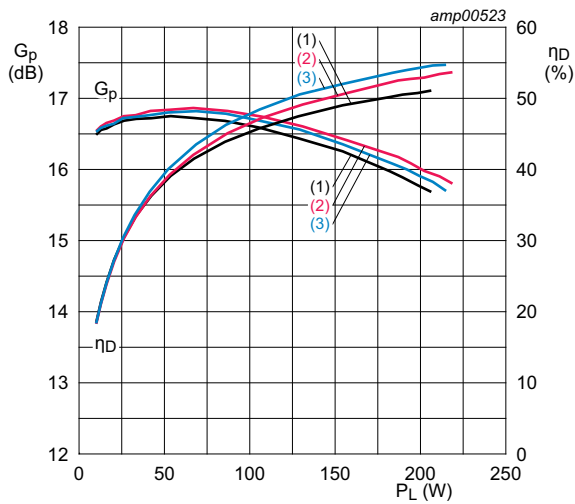

$V_{DS} = 32\text{ V}; I_{Dq} = 810\text{ mA}; V_{GS(amp)peak} = 0.5\text{ V}.$

- (1) $f = 1457\text{ MHz}$
- (2) $f = 1487\text{ MHz}$
- (3) $f = 1506\text{ MHz}$

Fig 9. Power gain and drain efficiency as function of output power; typical values

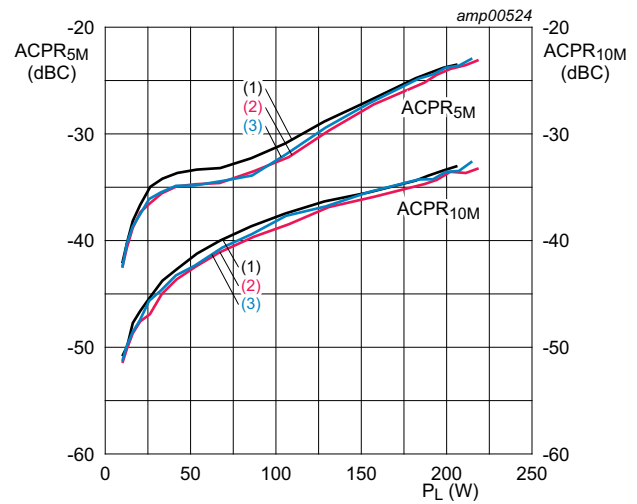

$V_{DS} = 32\text{ V}; I_{Dq} = 810\text{ mA}; V_{GS(amp)peak} = 0.5\text{ V}.$

- (1) $f = 1457\text{ MHz}$
- (2) $f = 1487\text{ MHz}$
- (3) $f = 1506\text{ MHz}$

Fig 10. Adjacent channel power ratio (5 MHz) and adjacent channel power ratio (10 MHz) as function of output power; typical values

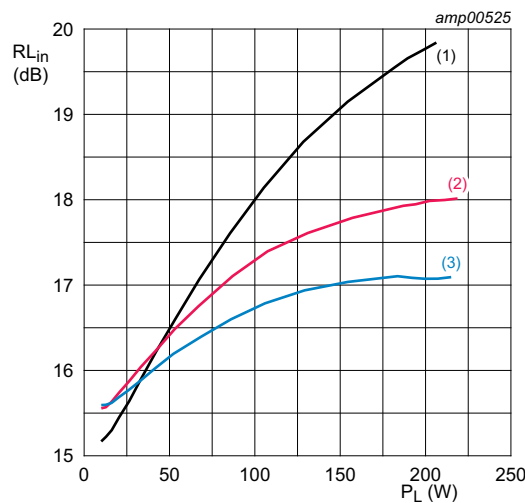

$V_{DS} = 32\text{ V}; I_{Dq} = 810\text{ mA}; V_{GS(amp)peak} = 0.5\text{ V}.$

- (1) $f = 1457\text{ MHz}$
- (2) $f = 1487\text{ MHz}$
- (3) $f = 1506\text{ MHz}$

Fig 11. Input return loss as a function of output power; typical values

7.5.4 2-Tone VBW

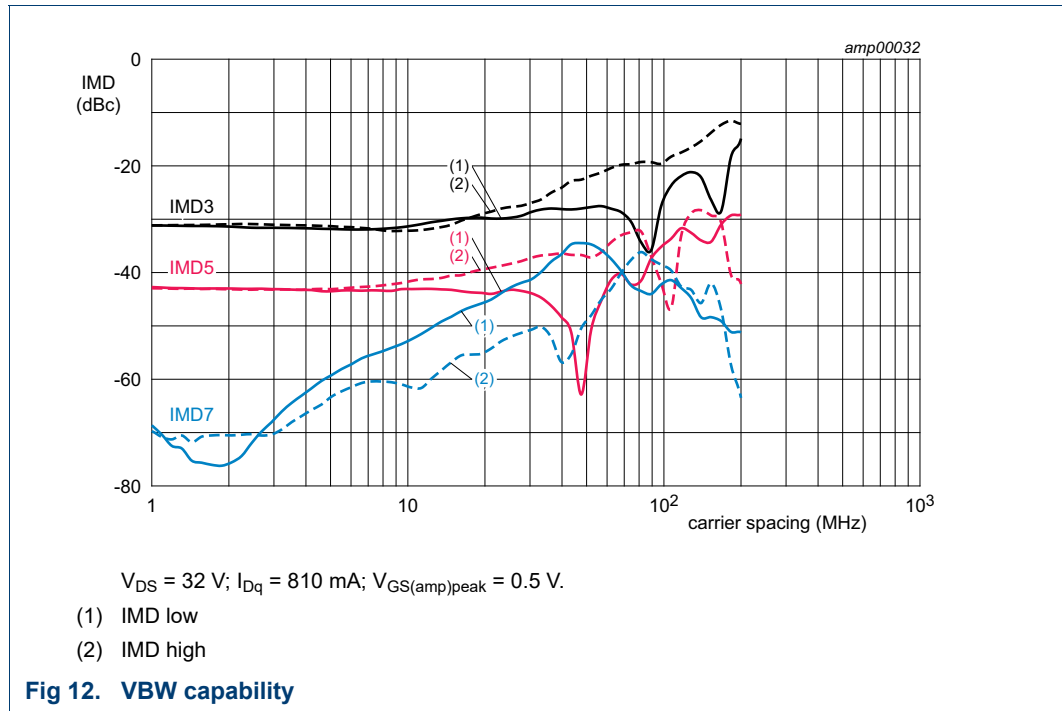

8. Package outline

Air cavity plastic earless flanged package; 6 leads

SOT1258-4

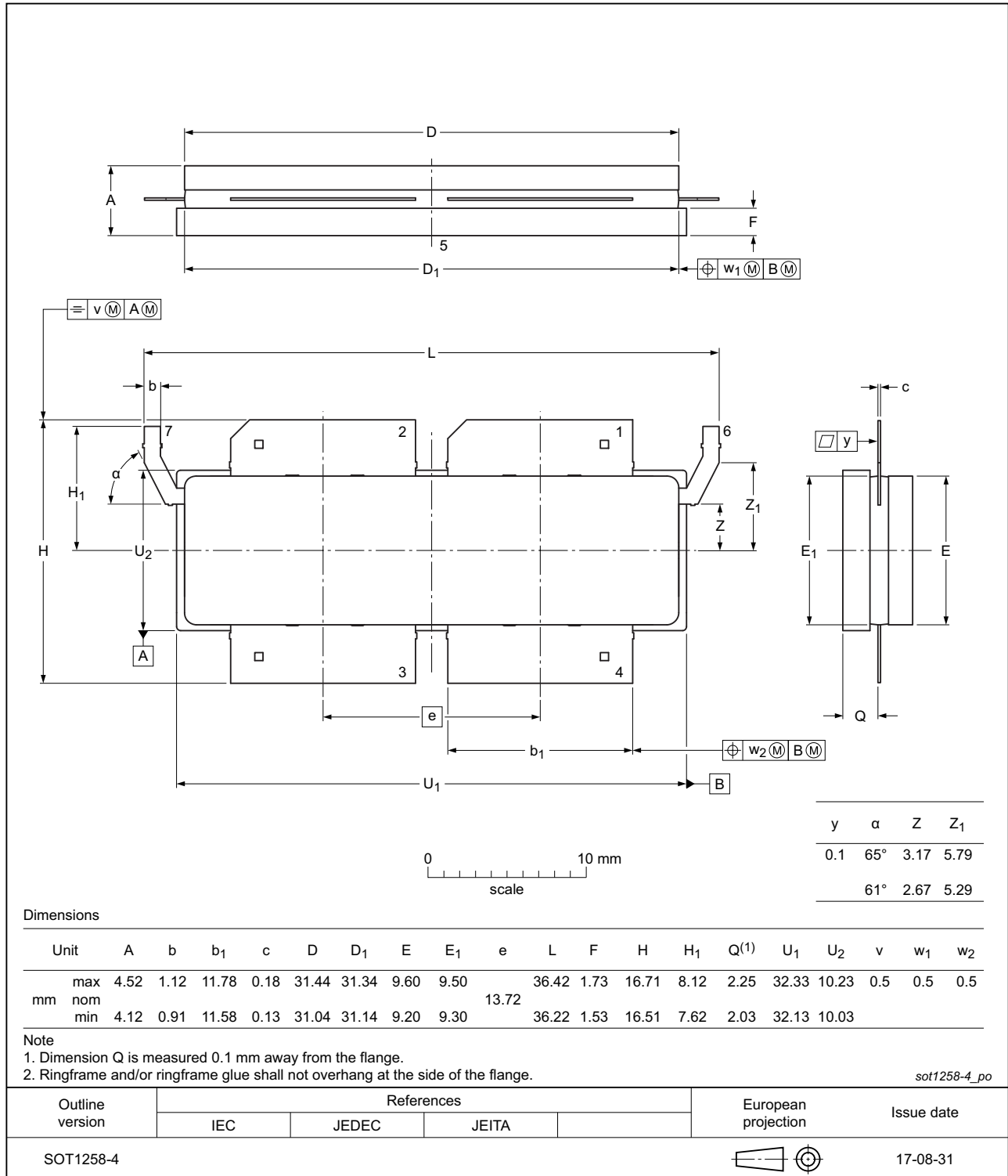

Fig 13. Package outline SOT1258-4

9. Handling information

CAUTION



This device is sensitive to ElectroStatic Discharge (ESD). Observe precautions for handling electrostatic sensitive devices.

Such precautions are described in the *ANSI/ESD S20.20*, *IEC/ST 61340-5*, *JESD625-A* or equivalent standards.

Table 16. ESD sensitivity

ESD model	Class
Charged Device Model (CDM); According to ANSI/ESDA/JEDEC standard JS-002	C2A [1]
Human Body Model (HBM); According to ANSI/ESDA/JEDEC standard JS-001	2 [2]

[1] CDM classification C2A is granted to any part that passes after exposure to an ESD pulse of 500 V, but fails after exposure to an ESD pulse of 750 V.

[2] HBM classification 2 is granted to any part that passes after exposure to an ESD pulse of 2000 V, but fails after exposure to an ESD pulse of 4000 V.

10. Abbreviations

Table 17. Abbreviations

Acronym	Description
3GPP	3rd Generation Partnership Project
AM	Amplitude Modulation
CCDF	Complementary Cumulative Distribution Function
CW	Continuous Wave
DPCH	Dedicated Physical CHannel
ESD	ElectroStatic Discharge
LDMOS	Laterally Diffused Metal-Oxide Semiconductor
MTF	Median Time to Failure
OBO	Output Back Off
PAR	Peak-to-Average Ratio
PM	Phase Modulation
SMD	Surface Mounted Device
VBW	Video Bandwidth
VSWR	Voltage Standing Wave Ratio
W-CDMA	Wideband Code Division Multiple Access

11. Revision history

Table 18. Revision history

Document ID	Release date	Data sheet status	Change notice	Supersedes
BLC9G15XS-400AVT v.1	20171124	Product data sheet	-	-

12. Legal information

12.1 Data sheet status

Document status ^{[1][2]}	Product status ^[3]	Definition
Objective [short] data sheet	Development	This document contains data from the objective specification for product development.
Preliminary [short] data sheet	Qualification	This document contains data from the preliminary specification.
Product [short] data sheet	Production	This document contains the product specification.

[1] Please consult the most recently issued document before initiating or completing a design.

[2] The term 'short data sheet' is explained in section "Definitions".

[3] The product status of device(s) described in this document may have changed since this document was published and may differ in case of multiple devices. The latest product status information is available on the Internet at URL <http://www.ampleon.com>.

12.2 Definitions

Draft — The document is a draft version only. The content is still under internal review and subject to formal approval, which may result in modifications or additions. Ampleon does not give any representations or warranties as to the accuracy or completeness of information included herein and shall have no liability for the consequences of use of such information.

Short data sheet — A short data sheet is an extract from a full data sheet with the same product type number(s) and title. A short data sheet is intended for quick reference only and should not be relied upon to contain detailed and full information. For detailed and full information see the relevant full data sheet, which is available on request via the local Ampleon sales office. In case of any inconsistency or conflict with the short data sheet, the full data sheet shall prevail.

Product specification — The information and data provided in a Product data sheet shall define the specification of the product as agreed between Ampleon and its customer, unless Ampleon and customer have explicitly agreed otherwise in writing. In no event however, shall an agreement be valid in which the Ampleon product is deemed to offer functions and qualities beyond those described in the Product data sheet.

12.3 Disclaimers

Limited warranty and liability — Information in this document is believed to be accurate and reliable. However, Ampleon does not give any representations or warranties, expressed or implied, as to the accuracy or completeness of such information and shall have no liability for the consequences of use of such information. Ampleon takes no responsibility for the content in this document if provided by an information source outside of Ampleon.

In no event shall Ampleon be liable for any indirect, incidental, punitive, special or consequential damages (including - without limitation - lost profits, lost savings, business interruption, costs related to the removal or replacement of any products or rework charges) whether or not such damages are based on tort (including negligence), warranty, breach of contract or any other legal theory.

Notwithstanding any damages that customer might incur for any reason whatsoever, Ampleon's aggregate and cumulative liability towards customer for the products described herein shall be limited in accordance with the *Terms and conditions of commercial sale* of Ampleon.

Right to make changes — Ampleon reserves the right to make changes to information published in this document, including without limitation specifications and product descriptions, at any time and without notice. This document supersedes and replaces all information supplied prior to the publication hereof.

Suitability for use — Ampleon products are not designed, authorized or warranted to be suitable for use in life support, life-critical or safety-critical systems or equipment, nor in applications where failure or malfunction of an

Ampleon product can reasonably be expected to result in personal injury, death or severe property or environmental damage. Ampleon and its suppliers accept no liability for inclusion and/or use of Ampleon products in such equipment or applications and therefore such inclusion and/or use is at the customer's own risk.

Applications — Applications that are described herein for any of these products are for illustrative purposes only. Ampleon makes no representation or warranty that such applications will be suitable for the specified use without further testing or modification.

Customers are responsible for the design and operation of their applications and products using Ampleon products, and Ampleon accepts no liability for any assistance with applications or customer product design. It is customer's sole responsibility to determine whether the Ampleon product is suitable and fit for the customer's applications and products planned, as well as for the planned application and use of customer's third party customer(s). Customers should provide appropriate design and operating safeguards to minimize the risks associated with their applications and products.

Ampleon does not accept any liability related to any default, damage, costs or problem which is based on any weakness or default in the customer's applications or products, or the application or use by customer's third party customer(s). Customer is responsible for doing all necessary testing for the customer's applications and products using Ampleon products in order to avoid a default of the applications and the products or of the application or use by customer's third party customer(s). Ampleon does not accept any liability in this respect.

Limiting values — Stress above one or more limiting values (as defined in the Absolute Maximum Ratings System of IEC 60134) will cause permanent damage to the device. Limiting values are stress ratings only and (proper) operation of the device at these or any other conditions above those given in the Recommended operating conditions section (if present) or the Characteristics sections of this document is not warranted. Constant or repeated exposure to limiting values will permanently and irreversibly affect the quality and reliability of the device.

Terms and conditions of commercial sale — Ampleon products are sold subject to the general terms and conditions of commercial sale, as published at <http://www.ampleon.com/terms>, unless otherwise agreed in a valid written individual agreement. In case an individual agreement is concluded only the terms and conditions of the respective agreement shall apply. Ampleon hereby expressly objects to applying the customer's general terms and conditions with regard to the purchase of Ampleon products by customer.

No offer to sell or license — Nothing in this document may be interpreted or construed as an offer to sell products that is open for acceptance or the grant, conveyance or implication of any license under any copyrights, patents or other industrial or intellectual property rights.

Export control — This document as well as the item(s) described herein may be subject to export control regulations. Export might require a prior authorization from competent authorities.

Non-automotive qualified products — Unless this data sheet expressly states that this specific Ampleon product is automotive qualified, the product is not suitable for automotive use. It is neither qualified nor tested in accordance with automotive testing or application requirements. Ampleon accepts no liability for inclusion and/or use of non-automotive qualified products in automotive equipment or applications.

In the event that customer uses the product for design-in and use in automotive applications to automotive specifications and standards, customer (a) shall use the product without Ampleon's warranty of the product for such automotive applications, use and specifications, and (b) whenever customer uses the product for automotive applications beyond Ampleon's specifications such use shall be solely at customer's own risk, and (c) customer fully indemnifies Ampleon for any liability, damages or failed product claims resulting from customer design and use of the product for automotive applications beyond Ampleon's standard warranty and Ampleon's product specifications.

Translations — A non-English (translated) version of a document is for reference only. The English version shall prevail in case of any discrepancy between the translated and English versions.

12.4 Trademarks

Notice: All referenced brands, product names, service names and trademarks are the property of their respective owners.

Any reference or use of any 'NXP' trademark in this document or in or on the surface of Ampleon products does not result in any claim, liability or entitlement vis-à-vis the owner of this trademark. Ampleon is no longer part of the NXP group of companies and any reference to or use of the 'NXP' trademarks will be replaced by reference to or use of Ampleon's own trademarks.

13. Contact information

For more information, please visit: <http://www.ampleon.com>

For sales office addresses, please visit: <http://www.ampleon.com/sales>

14. Contents

1 **Product profile** 1

1.1 General description 1

1.2 Features and benefits 1

1.3 Applications 1

2 **Pinning information** 2

3 **Ordering information** 2

4 **Limiting values** 2

5 **Thermal characteristics** 2

6 **Characteristics** 3

7 **Test information** 4

7.1 Ruggedness in Doherty operation 4

7.2 Impedance information 4

7.3 Recommended impedances for Doherty design 5

7.4 Test circuit. 6

7.5 Graphical data 7

7.5.1 Pulsed CW 7

7.5.2 1-Carrier W-CDMA 8

7.5.3 2-Carrier W-CDMA 9

7.5.4 2-Tone VBW 10

8 **Package outline** 11

9 **Handling information** 12

10 **Abbreviations** 12

11 **Revision history** 12

12 **Legal information** 13

12.1 Data sheet status 13

12.2 Definitions 13

12.3 Disclaimers 13

12.4 Trademarks 14

13 **Contact information** 14

14 **Contents** 15

Please be aware that important notices concerning this document and the product(s) described herein, have been included in section 'Legal information'.

© Ampleon Netherlands B.V. 2017. All rights reserved.

For more information, please visit: <http://www.ampleon.com>
 For sales office addresses, please visit: <http://www.ampleon.com/sales>

Date of release: 24 November 2017
 Document identifier: BLC9G15XS-400AVT