



Chipsmall Limited consists of a professional team with an average of over 10 year of expertise in the distribution of electronic components. Based in Hongkong, we have already established firm and mutual-benefit business relationships with customers from,Europe,America and south Asia,supplying obsolete and hard-to-find components to meet their specific needs.

With the principle of “Quality Parts,Customers Priority,Honest Operation,and Considerate Service”,our business mainly focus on the distribution of electronic components. Line cards we deal with include Microchip,ALPS,ROHM,Xilinx,Pulse,ON,Everlight and Freescale. Main products comprise IC,Modules,Potentiometer,IC Socket,Relay,Connector.Our parts cover such applications as commercial,industrial, and automotives areas.

We are looking forward to setting up business relationship with you and hope to provide you with the best service and solution. Let us make a better world for our industry!



Contact us

Tel: +86-755-8981 8866 Fax: +86-755-8427 6832

Email & Skype: info@chipsmall.com Web: www.chipsmall.com

Address: A1208, Overseas Decoration Building, #122 Zhenhua RD., Futian, Shenzhen, China



BLF6G15L-500H; BLF6G15LS-500H

Power LDMOS transistor

Rev. 4 — 1 September

AMPLEON

Product data sheet

1. Product profile

1.1 General description

A 500 W LDMOS RF power transistor for transmitter applications and industrial applications. The transistor is optimized for digital applications and can deliver 65 W average DVB-T at 1.5 GHz. The excellent ruggedness of this device makes it ideal for digital transmitter applications.

Table 1. Test information

RF performance at $V_{DS} = 50\text{ V}$; $I_{DQ} = 1.3\text{ A}$.

Mode of operation	f (MHz)	$P_{L(AV)}$ (W)	G_p (dB)	η_D (%)	IMD3 (dBc)	IMD _{shldr} (dBc)	PAR (dB)
2-tone, class-AB	1452 to 1492	250	15	34	-24	-	-
DVB-T (8k OFDM)	1452 to 1492	65	16	19	-	-32 [1]	9 [2]

[1] Measured [dBc] with delta marker at 4.3 MHz from center frequency.

[2] PAR (of output signal) at 0.01 % probability on CCDF; PAR of input signal = 9.5 dB at 0.01 % probability on CCDF.

1.2 Features and benefits

- Easy power control
- Integrated ESD protection
- Excellent ruggedness
- High efficiency
- Excellent thermal stability
- Internally matched for ease of use
- Compliant to Directive 2002/95/EC, regarding Restriction of Hazardous Substances (RoHS)

1.3 Applications

- Digital transmitter applications DVB at 1.5 GHz
- Industrial applications at 1.5 GHz

2. Pinning information

Table 2. Pinning

Pin	Description	Simplified outline	Graphic symbol
BLF6G15L-500H (SOT539A)			
1	drain1		 sym117
2	drain2		
3	gate1		
4	gate2		
5	source		
BLF6G15LS-500H (SOT539B)			
1	drain1		 sym117
2	drain2		
3	gate1		
4	gate2		
5	source		

[1] Connected to flange.

3. Ordering information

Table 3. Ordering information

Type number	Package		
	Name	Description	Version
BLF6G15L-500H	-	flanged balanced LDMOST ceramic package; 2 mounting holes; 4 leads	SOT539A
BLF6G15LS-500H	-	earless flanged balanced LDMOST ceramic package; 4 leads	SOT539B

4. Limiting values

Table 4. Limiting values

In accordance with the Absolute Maximum Rating System (IEC 60134).

Symbol	Parameter	Conditions	Min	Max	Unit
V_{DS}	drain-source voltage		-	100	V
V_{GS}	gate-source voltage		-0.5	+13	V
I_D	drain current		-	45	A
T_{stg}	storage temperature		-65	+150	°C
T_j	junction temperature		-	200	°C

5. Thermal characteristics

Table 5. Thermal characteristics

Symbol	Parameter	Conditions	Typ	Unit
$R_{th(j-case)}$	thermal resistance from junction to case	$T_{case} = 85\text{ °C}; P_L = 65\text{ W}$	0.18	K/W

6. Characteristics

Table 6. DC characteristics

$T_j = 25\text{ °C}$; per section unless otherwise specified.

Symbol	Parameter	Conditions	Min	Typ	Max	Unit
$V_{(BR)DSS}$	drain-source breakdown voltage	$V_{GS} = 0\text{ V}; I_D = 2.7\text{ mA}$	100	-	-	V
$V_{GS(th)}$	gate-source threshold voltage	$V_{DS} = 10\text{ V}; I_D = 270\text{ mA}$	1.4	1.8	2.4	V
I_{DSS}	drain leakage current	$V_{GS} = 0\text{ V}; V_{DS} = 50\text{ V}$	-	-	2.8	μA
I_{DSX}	drain cut-off current	$V_{GS} = V_{GS(th)} + 3.75\text{ V}; V_{DS} = 10\text{ V}$	38	42	-	A
I_{GSS}	gate leakage current	$V_{GS} = 11\text{ V}; V_{DS} = 0\text{ V}$	-	-	280	nA
g_{fs}	forward transconductance	$V_{DS} = 10\text{ V}; I_D = 270\text{ mA}$	1.33	2.3	-	S
$R_{DS(on)}$	drain-source on-state resistance	$V_{GS} = V_{GS(th)} + 3.75\text{ V}; I_D = 9.5\text{ A}$	-	100	193	$\text{m}\Omega$

Table 7. RF characteristics

RF characteristics in Ampleon class-AB production circuit, in frequency range 1452 MHz to 1492 MHz; $T_{case} = 25\text{ °C}$.

Symbol	Parameter	Conditions	Min	Typ	Max	Unit
DVB-T (8k OFDM), class-AB						
V_{DS}	drain-source voltage		-	50	-	V
I_{Dq}	quiescent drain current		-	1.3	-	A
$P_{L(AV)}$	average output power		-	65	-	W
G_p	power gain		14.5	16	-	dB
η_D	drain efficiency		16	19	-	%
IMD_{shldr}	intermodulation distortion shoulder		[1]	-32	-30	dBc
PAR	peak-to-average ratio		[2]	8.5	9	dB

[1] Measured [dBc] with delta marker at 4.3 MHz from center frequency.

[2] PAR (of output signal) at 0.01 % probability on CCDF; PAR of input signal = 9.5 dB at 0.01 % probability on CCDF.

6.1 Ruggedness in class-AB operation

The BLF6G15L-500H and BLF6G15LS-500H are capable of withstanding a load mismatch corresponding to VSWR = 10 : 1 through all phases under the following conditions: $V_{DS} = 50\text{ V}; I_{Dq} = 1.3\text{ A}$ at rated power.

7. Application information

7.1 Impedance information

Table 8. Typical impedance
Typical values per section unless otherwise specified.

f MHz	Z _S Ω	Z _L Ω
1452	1.226 – j2.663	2.137 – j2.750
1472	1.375 – j2.757	1.869 – j2.378
1492	1.15 – j2.735	1.817 – j2.684

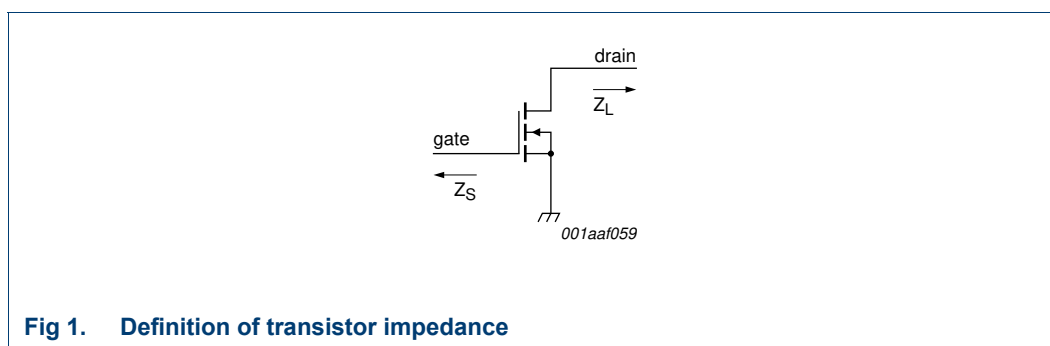
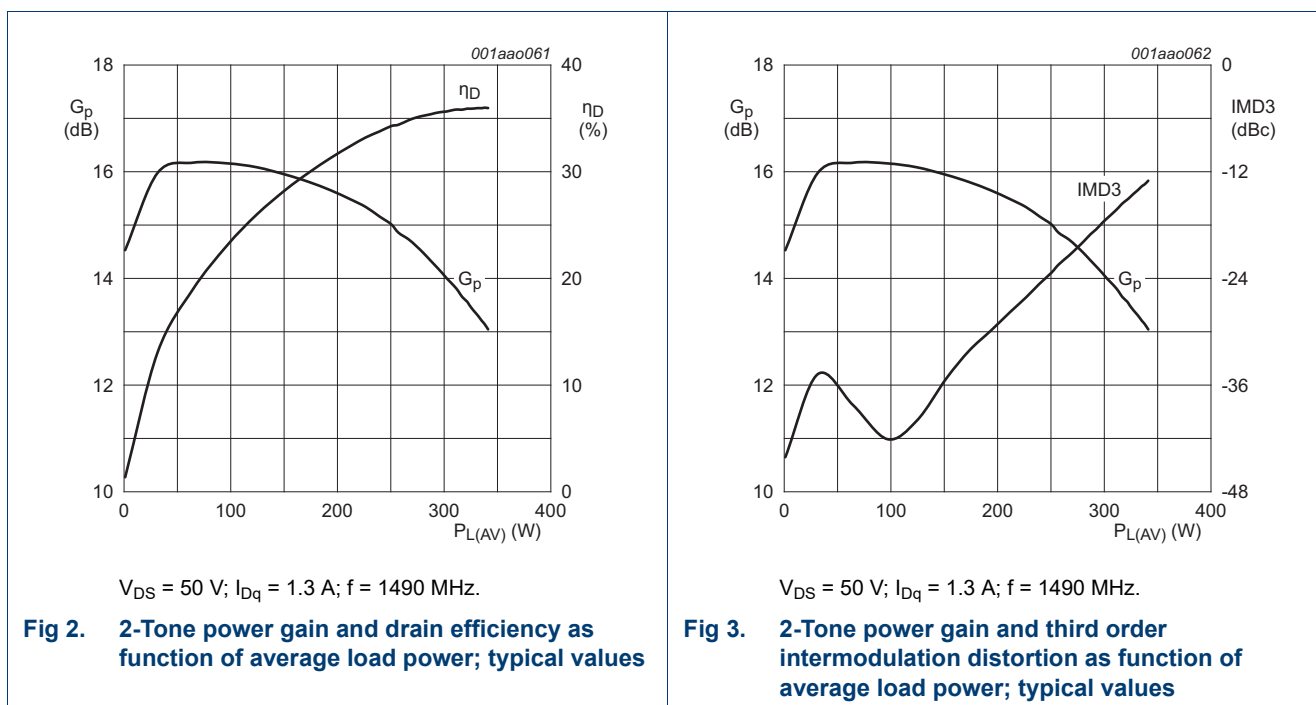

Fig 1. Definition of transistor impedance

7.2 Graphs

7.2.1 2-Tone



7.2.2 DVB-T

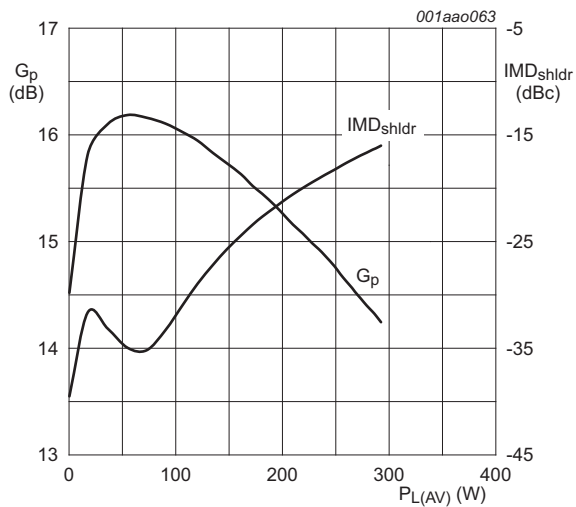

$V_{DS} = 50\text{ V}$; $I_{Dq} = 1.3\text{ A}$; $f = 1490\text{ MHz}$.

Fig 4. DVB-T power gain and intermodulation distortion shoulder as function of average load power; typical values

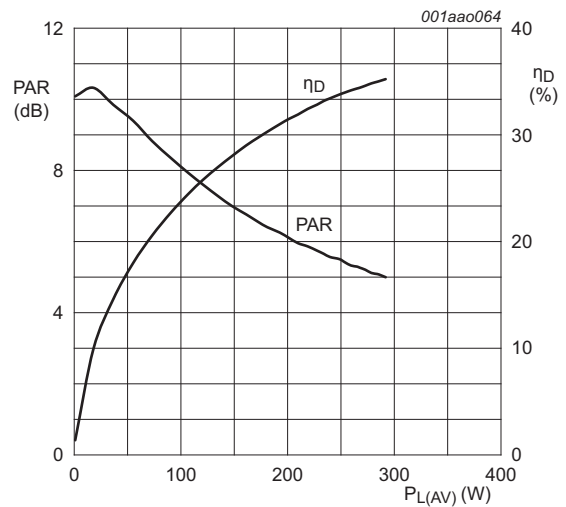

$V_{DS} = 50\text{ V}$; $I_{Dq} = 1.3\text{ A}$; $f = 1490\text{ MHz}$.

Fig 5. DVB-T peak-to-average ratio and drain efficiency as function of average load power; typical values

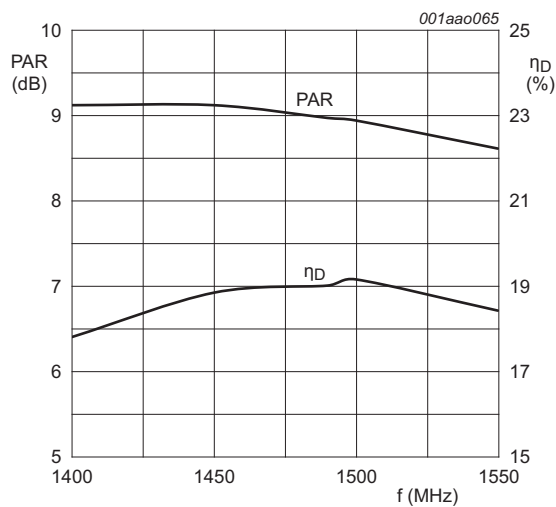

$V_{DS} = 50\text{ V}$; $I_{Dq} = 1.3\text{ A}$; $P_{L(AV)} = 65\text{ W}$.

Fig 6. DVB-T peak-to-average ratio and drain efficiency as function of frequency; typical values

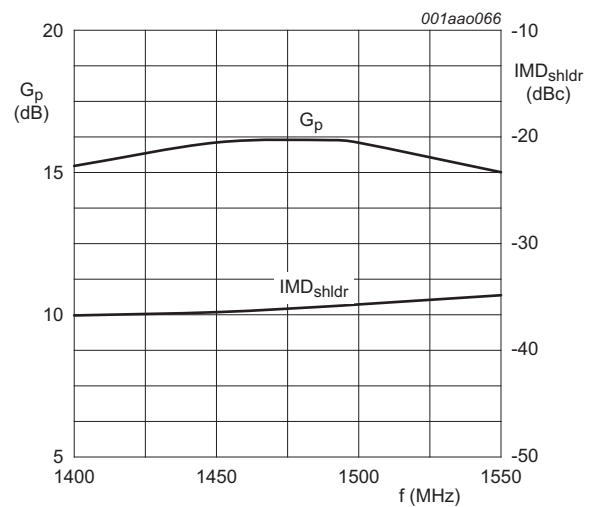

$V_{DS} = 50\text{ V}$; $I_{Dq} = 1.3\text{ A}$; $P_{L(AV)} = 65\text{ W}$.

Fig 7. DVB-T power gain and intermodulation distortion shoulder as a function of frequency; typical values

7.2.3 Reliability

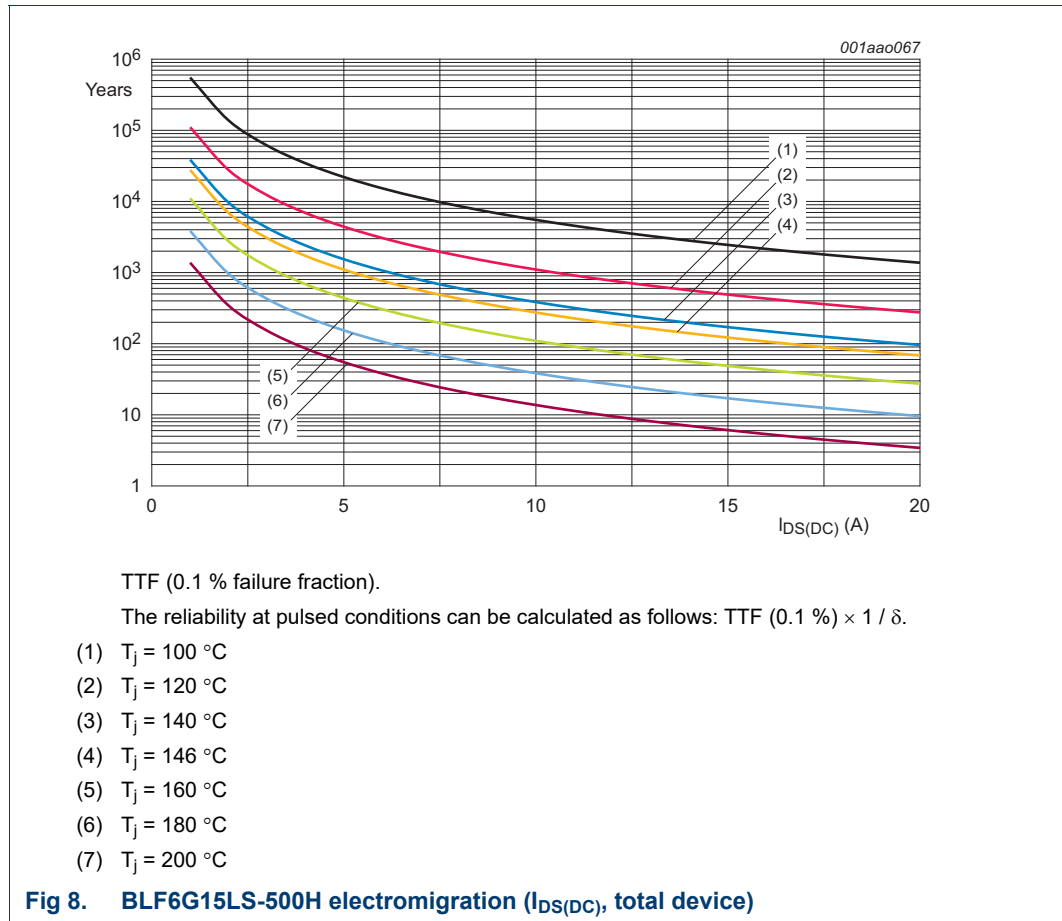

7.3 Test circuit

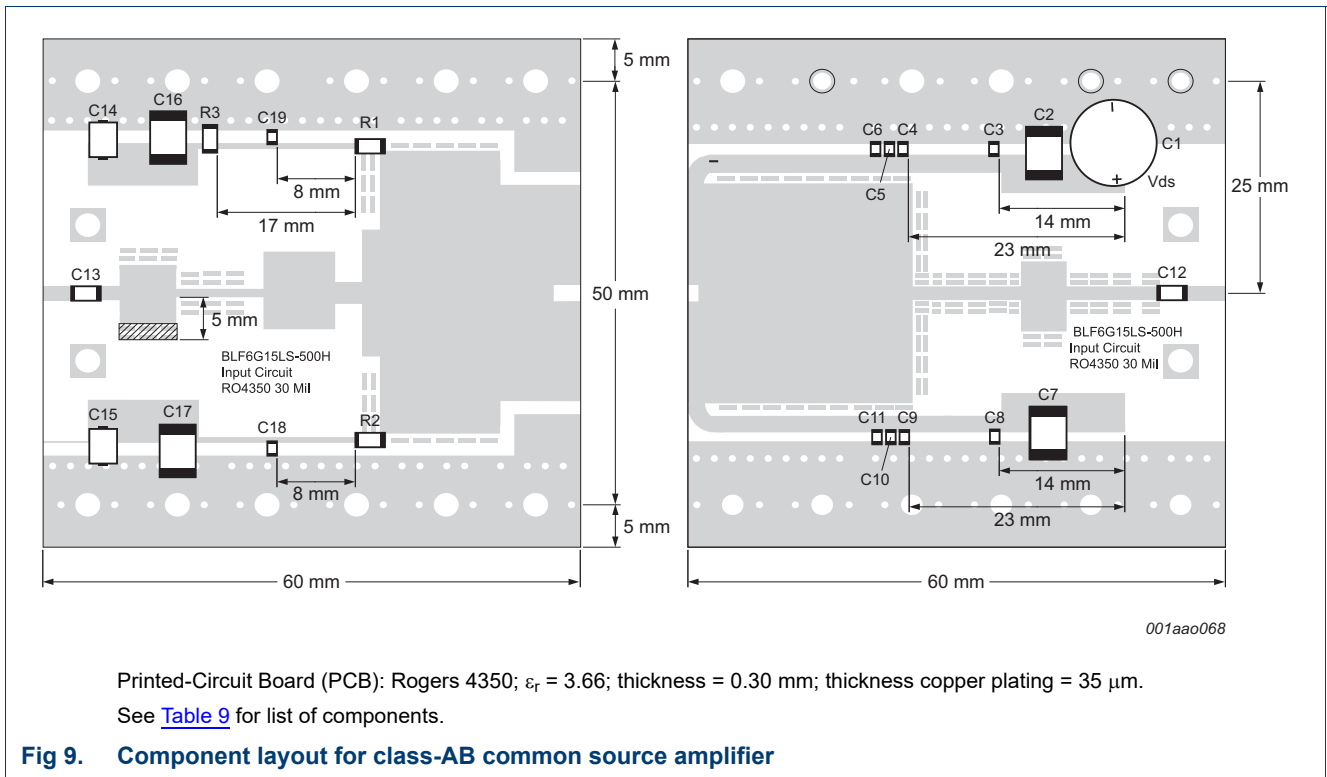

Table 9. List of components
See [Figure 9](#) for component layout.

Component	Description	Value	Remarks
C1	electrolytic capacitor	470 μF , 63 V	Elco
C2, C7, C16, C17	multilayer ceramic chip capacitor	10 μF	TDK
C3, C8	multilayer ceramic chip capacitor	6.2 pF	ATC800B
C4, C5, C9, C10	multilayer ceramic chip capacitor	1.0 μF	1206 10 %
C6, C11	multilayer ceramic chip capacitor	10 nF	1205 10 %
C12, C13	multilayer ceramic chip capacitor	22 pF	ATC800B
C18, C19	multilayer ceramic chip capacitor	22 pF	ATC800B
C15	electrolytic capacitor	470 μF ; 63 V	
R1, R2	SMD resistor	5R1 Ω	0805
R3	SMD resistor	470 Ω (not fitted)	1206

8. Package outline

Flanged balanced ceramic package; 2 mounting holes; 4 leads

SOT539A

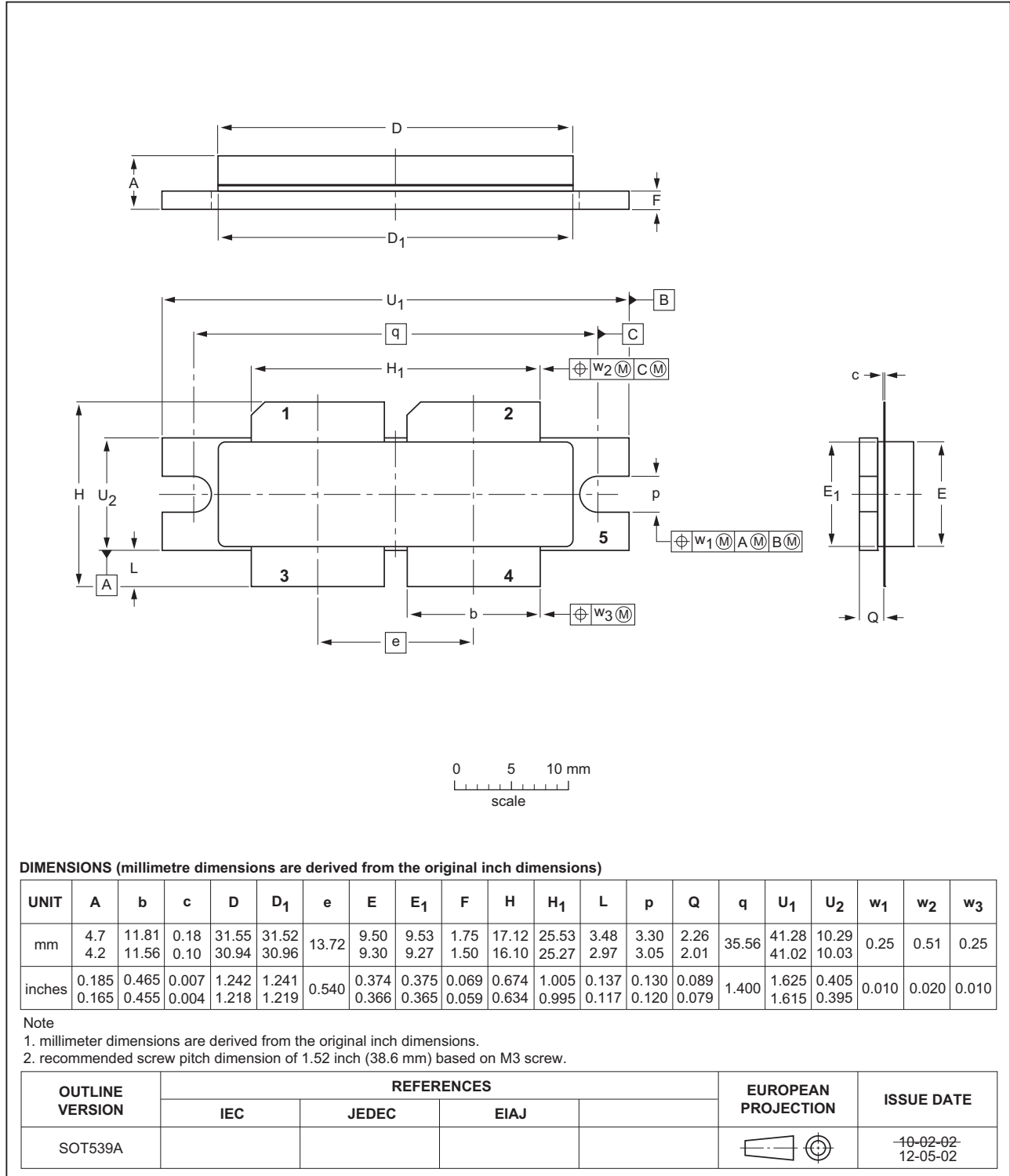

Fig 10. Package outline SOT539A

Earless flanged balanced ceramic package; 4 leads

SOT539B

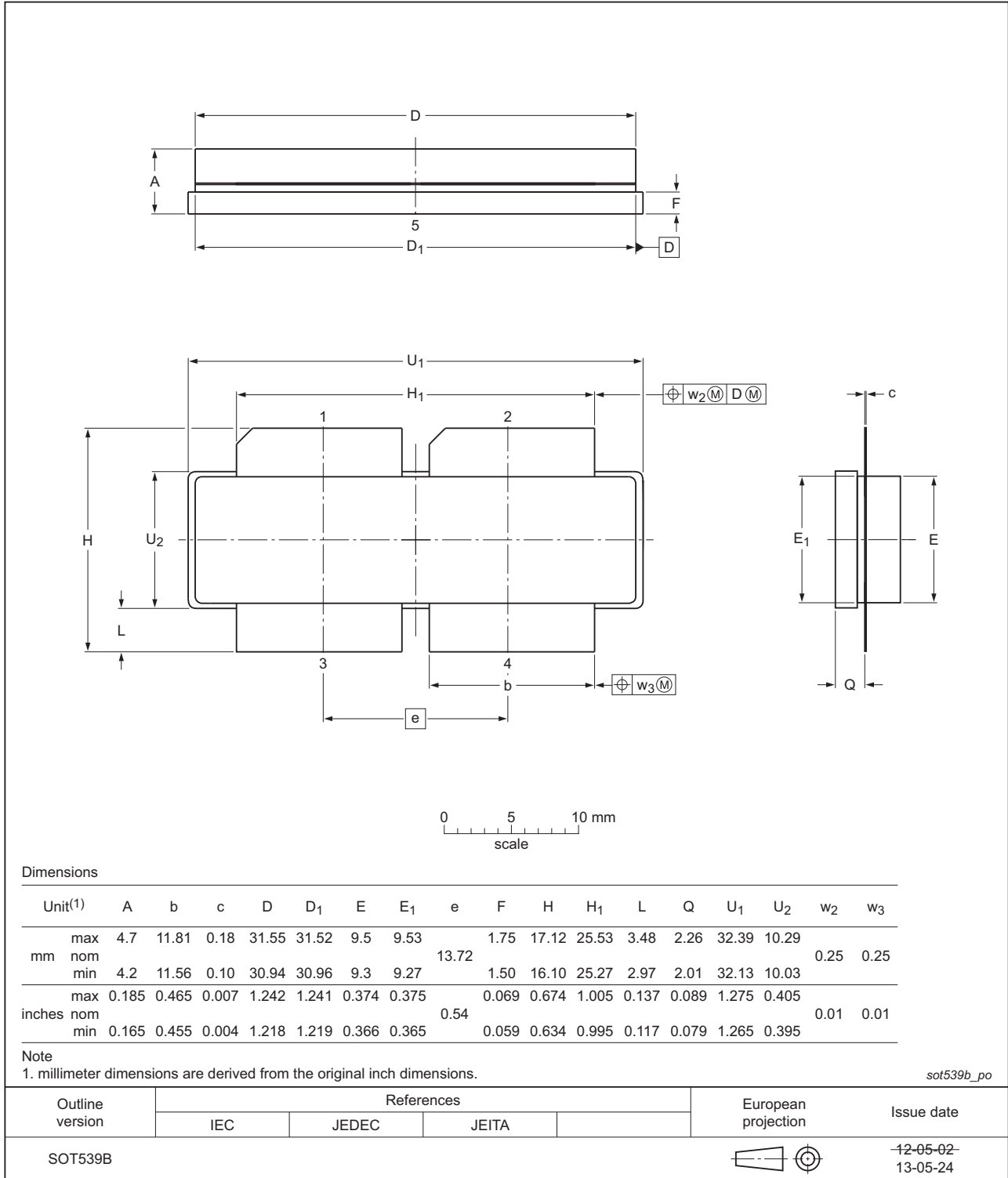

Fig 11. Package outline SOT539B

9. Handling information

CAUTION



This device is sensitive to ElectroStatic Discharge (ESD). Observe precautions for handling electrostatic sensitive devices.

Such precautions are described in the *ANSI/ESD S20.20*, *IEC/ST 61340-5*, *JESD625-A* or equivalent standards.

10. Abbreviations

Table 10. Abbreviations

Acronym	Description
CCDF	Complementary Cumulative Distribution Function
DVB-T	Digital Video Broadcast - Terrestrial
DVB	Digital Video Broadcast
ESD	ElectroStatic Discharge
LDMOS	Laterally Diffused Metal-Oxide Semiconductor
LDMOST	Laterally Diffused Metal-Oxide Semiconductor Transistor
OFDM	Orthogonal Frequency Division Multiplexing
PAR	Peak-to-Average power Ratio
RF	Radio Frequency
SMD	Surface Mounted Device
TTF	Time To Failure
VSWR	Voltage Standing-Wave Ratio

11. Revision history

Table 11. Revision history

Document ID	Release date	Data sheet status	Change notice	Supersedes
BLF6G15L-500H_6G15LS-500H#4	20150901	Product data sheet	-	BLF6G15L-500H_6G15LS-500H v.3
Modifications:	<ul style="list-style-type: none"> The format of this document has been redesigned to comply with the new identity guidelines of Ampleon. Legal texts have been adapted to the new company name where appropriate. 			
BLF6G15L-500H_6G15LS-500H v.3	20130712	Product data sheet	-	BLF6G15L-500H_6G15LS-500H v.2
BLF6G15L-500H_6G15LS-500H v.2	20110916	Product data sheet	-	BLF6G15L-500H_6G15LS-500H v.1
BLF6G15L-500H_6G15LS-500H v.1	20110511	Objective data sheet	-	-

12. Legal information

12.1 Data sheet status

Document status ^{[1][2]}	Product status ^[3]	Definition
Objective [short] data sheet	Development	This document contains data from the objective specification for product development.
Preliminary [short] data sheet	Qualification	This document contains data from the preliminary specification.
Product [short] data sheet	Production	This document contains the product specification.

[1] Please consult the most recently issued document before initiating or completing a design.

[2] The term 'short data sheet' is explained in section "Definitions".

[3] The product status of device(s) described in this document may have changed since this document was published and may differ in case of multiple devices. The latest product status information is available on the Internet at URL <http://www.ampleon.com>.

12.2 Definitions

Draft — The document is a draft version only. The content is still under internal review and subject to formal approval, which may result in modifications or additions. Ampleon does not give any representations or warranties as to the accuracy or completeness of information included herein and shall have no liability for the consequences of use of such information.

Short data sheet — A short data sheet is an extract from a full data sheet with the same product type number(s) and title. A short data sheet is intended for quick reference only and should not be relied upon to contain detailed and full information. For detailed and full information see the relevant full data sheet, which is available on request via the local Ampleon sales office. In case of any inconsistency or conflict with the short data sheet, the full data sheet shall prevail.

Product specification — The information and data provided in a Product data sheet shall define the specification of the product as agreed between Ampleon and its customer, unless Ampleon and customer have explicitly agreed otherwise in writing. In no event however, shall an agreement be valid in which the Ampleon product is deemed to offer functions and qualities beyond those described in the Product data sheet.

12.3 Disclaimers

Limited warranty and liability — Information in this document is believed to be accurate and reliable. However, Ampleon does not give any representations or warranties, expressed or implied, as to the accuracy or completeness of such information and shall have no liability for the consequences of use of such information. Ampleon takes no responsibility for the content in this document if provided by an information source outside of Ampleon.

In no event shall Ampleon be liable for any indirect, incidental, punitive, special or consequential damages (including - without limitation - lost profits, lost savings, business interruption, costs related to the removal or replacement of any products or rework charges) whether or not such damages are based on tort (including negligence), warranty, breach of contract or any other legal theory.

Notwithstanding any damages that customer might incur for any reason whatsoever, Ampleon' aggregate and cumulative liability towards customer for the products described herein shall be limited in accordance with the *Terms and conditions of commercial sale* of Ampleon.

Right to make changes — Ampleon reserves the right to make changes to information published in this document, including without limitation specifications and product descriptions, at any time and without notice. This document supersedes and replaces all information supplied prior to the publication hereof.

Suitability for use — Ampleon products are not designed, authorized or warranted to be suitable for use in life support, life-critical or safety-critical systems or equipment, nor in applications where failure or malfunction of an

Ampleon product can reasonably be expected to result in personal injury, death or severe property or environmental damage. Ampleon and its suppliers accept no liability for inclusion and/or use of Ampleon products in such equipment or applications and therefore such inclusion and/or use is at the customer's own risk.

Applications — Applications that are described herein for any of these products are for illustrative purposes only. Ampleon makes no representation or warranty that such applications will be suitable for the specified use without further testing or modification.

Customers are responsible for the design and operation of their applications and products using Ampleon products, and Ampleon accepts no liability for any assistance with applications or customer product design. It is customer's sole responsibility to determine whether the Ampleon product is suitable and fit for the customer's applications and products planned, as well as for the planned application and use of customer's third party customer(s). Customers should provide appropriate design and operating safeguards to minimize the risks associated with their applications and products.

Ampleon does not accept any liability related to any default, damage, costs or problem which is based on any weakness or default in the customer's applications or products, or the application or use by customer's third party customer(s). Customer is responsible for doing all necessary testing for the customer's applications and products using Ampleon products in order to avoid a default of the applications and the products or of the application or use by customer's third party customer(s). Ampleon does not accept any liability in this respect.

Limiting values — Stress above one or more limiting values (as defined in the Absolute Maximum Ratings System of IEC 60134) will cause permanent damage to the device. Limiting values are stress ratings only and (proper) operation of the device at these or any other conditions above those given in the Recommended operating conditions section (if present) or the Characteristics sections of this document is not warranted. Constant or repeated exposure to limiting values will permanently and irreversibly affect the quality and reliability of the device.

Terms and conditions of commercial sale — Ampleon products are sold subject to the general terms and conditions of commercial sale, as published at <http://www.ampleon.com/terms>, unless otherwise agreed in a valid written individual agreement. In case an individual agreement is concluded only the terms and conditions of the respective agreement shall apply. Ampleon hereby expressly objects to applying the customer's general terms and conditions with regard to the purchase of Ampleon products by customer.

No offer to sell or license — Nothing in this document may be interpreted or construed as an offer to sell products that is open for acceptance or the grant, conveyance or implication of any license under any copyrights, patents or other industrial or intellectual property rights.

Export control — This document as well as the item(s) described herein may be subject to export control regulations. Export might require a prior authorization from competent authorities.

Non-automotive qualified products — Unless this data sheet expressly states that this specific Ampleon product is automotive qualified, the product is not suitable for automotive use. It is neither qualified nor tested in accordance with automotive testing or application requirements. Ampleon accepts no liability for inclusion and/or use of non-automotive qualified products in automotive equipment or applications.

In the event that customer uses the product for design-in and use in automotive applications to automotive specifications and standards, customer (a) shall use the product without Ampleon' warranty of the product for such automotive applications, use and specifications, and (b) whenever customer uses the product for automotive applications beyond Ampleon' specifications such use shall be solely at customer's own risk, and (c) customer fully indemnifies Ampleon for any liability, damages or failed product claims resulting from customer design and use of the product for automotive applications beyond Ampleon' standard warranty and Ampleon' product specifications.

Translations — A non-English (translated) version of a document is for reference only. The English version shall prevail in case of any discrepancy between the translated and English versions.

13. Contact information

For more information, please visit:
<http://www.ampleon.com>

12.4 Trademarks

Notice: All referenced brands, product names, service names and trademarks are the property of their respective owners.

Any reference or use of any 'NXP' trademark in this document or in or on the surface of Ampleon products does not result in any claim, liability or entitlement vis-à-vis the owner of this trademark. Ampleon is no longer part of the NXP group of companies and any reference to or use of the 'NXP' trademarks will be replaced by reference to or use of Ampleon's own Any reference or use of any 'NXP' trademark in this document or in or on the surface of Ampleon products does not result in any claim, liability or entitlement vis-à-vis the owner of this trademark. Ampleon is no longer part of the NXP group of companies and any reference to or use of the 'NXP' trademarks will be replaced by reference to or use of Ampleon's own trademarks.

For sales office addresses, please visit:
<http://www.ampleon.com/sales>

14. Contents

1 **Product profile** 1

1.1 General description 1

1.2 Features and benefits 1

1.3 Applications 1

2 **Pinning information** 2

3 **Ordering information** 2

4 **Limiting values** 2

5 **Thermal characteristics** 3

6 **Characteristics** 3

6.1 Ruggedness in class-AB operation 3

7 **Application information** 4

7.1 Impedance information 4

7.2 Graphs 4

7.2.1 2-Tone 4

7.2.2 DVB-T 5

7.2.3 Reliability 6

7.3 Test circuit 7

8 **Package outline** 8

9 **Handling information** 10

10 **Abbreviations** 10

11 **Revision history** 10

12 **Legal information** 11

12.1 Data sheet status 11

12.2 Definitions 11

12.3 Disclaimers 11

12.4 Licenses 12

12.5 Trademarks 12

13 **Contact information** 12

14 **Contents** 13

Please be aware that important notices concerning this document and the product(s) described herein, have been included in section 'Legal information'.

© Ampleon The Netherlands B.V. 2015. All rights reserved.

For more information, please visit: <http://www.ampleon.com>
 For sales office addresses, please visit: <http://www.ampleon.com/sales>

Date of release: 1 September

Document identifier: BLF6G15L-500H_6G15LS-500H#4