



Chipsmall Limited consists of a professional team with an average of over 10 year of expertise in the distribution of electronic components. Based in Hongkong, we have already established firm and mutual-benefit business relationships with customers from,Europe,America and south Asia,supplying obsolete and hard-to-find components to meet their specific needs.

With the principle of “Quality Parts,Customers Priority,Honest Operation,and Considerate Service”,our business mainly focus on the distribution of electronic components. Line cards we deal with include Microchip,ALPS,ROHM,Xilinx,Pulse,ON,Everlight and Freescale. Main products comprise IC,Modules,Potentiometer,IC Socket,Relay,Connector.Our parts cover such applications as commercial,industrial, and automotives areas.

We are looking forward to setting up business relationship with you and hope to provide you with the best service and solution. Let us make a better world for our industry!



## Contact us

Tel: +86-755-8981 8866 Fax: +86-755-8427 6832

Email & Skype: info@chipsmall.com Web: www.chipsmall.com

Address: A1208, Overseas Decoration Building, #122 Zhenhua RD., Futian, Shenzhen, China



## Chip Ferrite Bead BLM21□□□□□□N1□ Reference Specification

### 1. Scope

This reference specification applies to Chip Ferrite Bead BLM21\_□N Series.

### 2. Part Numbering

(ex.) 

|     |     |     |     |     |     |     |     |     |
|-----|-----|-----|-----|-----|-----|-----|-----|-----|
| BL  | M   | 21  | AG  | 121 | S   | N   | 1   | D   |
| (1) | (2) | (3) | (4) | (5) | (6) | (7) | (8) | (9) |

(1)Product ID

(2)Type

(3)Dimension (L×W)

(4)Characteristics

(5)Typical Impedance at 100MHz

(6)Performance

(7)Category

(8)Numbers of Circuit

(9)Packaging

[ D:Taping( φ 180mm Reel, Paper Tape)

L:Taping( φ 180mm Reel, Plastic Tape)

B:Bulk

### 3. Rating

| Customer Part Number | MURATA Part Number               | Impedance (Ω)<br>(at 100MHz, Under Standard Testing Condition) |      | Rated Current (mA)(*1) |            | DC Resistance (Ω) max. |                      | Remark                     |                       |
|----------------------|----------------------------------|--|------|------------------------|------------|------------------------|----------------------|----------------------------|-----------------------|
|                      |                                  | Typical  |      | at 85°C                | at 125°C   | Initial Values         | Values After Testing |                            |                       |
|                      | BLM21PG220SN1D<br>BLM21PG220SN1B | 22±25%   | 22   | *1<br>6000             | *1<br>3300 | 0.009                  | 0.018                | For DC power line          |                       |
|                      | BLM21PG300SN1D<br>BLM21PG300SN1B | 20 min.  | 30   | *1<br>4000             | *1<br>2300 | 0.014                  | 0.028                |                            |                       |
|                      | BLM21PG600SN1D<br>BLM21PG600SN1B | 60±25%   | 60   | *1<br>3500             | *1<br>1900 | 0.02                   | 0.04                 |                            |                       |
|                      | BLM21PG121SN1D<br>BLM21PG121SN1B | 120±25%  | 120  | *1<br>3000             | *1<br>1550 | 0.03                   | 0.06                 |                            |                       |
|                      | BLM21PG221SN1D<br>BLM21PG221SN1B | 220±25%  | 220  | *1<br>2000             | *1<br>1250 | 0.045                  | 0.09                 |                            |                       |
|                      | BLM21PG331SN1D<br>BLM21PG331SN1B | 330±25%  | 330  | *1<br>1500             | *1<br>1000 | 0.07                   | 0.14                 |                            |                       |
|                      | BLM21SN300SN1D<br>BLM21SN300SN1B | 30±10Ω   | 30   | *1<br>8500             | *1<br>6000 | 0.004                  | 0.005                |                            |                       |
|                      | BLM21RK121SN1D<br>BLM21RK121SN1B | 120±25%  | 120  | 200                    |            | 0.15                   | 0.25                 |                            | For Digital Interface |
|                      | BLM21RK221SN1D<br>BLM21RK221SN1B | 220±25%  | 220  | 200                    |            | 0.20                   | 0.30                 |                            |                       |
|                      | BLM21RK471SN1D<br>BLM21RK471SN1B | 470±25%  | 470  | 200                    |            | 0.25                   | 0.35                 |                            |                       |
|                      | BLM21RK601SN1D<br>BLM21RK601SN1B | 600±25%  | 600  | 200                    |            | 0.30                   | 0.40                 |                            |                       |
|                      | BLM21RK102SN1D<br>BLM21RK102SN1B | 1000±25%   | 1000 | 200                    |            | 0.50                   | 0.60                 |                            |                       |
|                      | BLM21BB050SN1D<br>BLM21BB050SN1B | 5±25%  | 5    | 1000                   |            | 0.02                   | 0.04                 | For high speed signal line |                       |
|                      | BLM21BB600SN1D<br>BLM21BB600SN1B | 60±25%   | 60   | 800                    |            | 0.13                   | 0.23                 |                            |                       |
|                      | BLM21BB750SN1D<br>BLM21BB750SN1B | 75±25%   | 75   | 700                    |            | 0.16                   | 0.26                 |                            |                       |
|                      | BLM21BB121SN1D<br>BLM21BB121SN1B | 120±25%  | 120  | 600                    |            | 0.19                   | 0.29                 |                            |                       |
|                      | BLM21BD121SN1D<br>BLM21BD121SN1B | 120±25%  | 120  | 350                    |            | 0.25                   | 0.35                 |                            |                       |

| Customer Part Number | MURATA Part Number | Impedance ( $\Omega$ )<br>(at 100MHz, Under Standard Testing Condition) |      | Rated Current (mA) | DC Resistance ( $\Omega$ ) max. |                      | Remark                     |
|----------------------|--------------------|---|------|--------------------|---------------------------------|----------------------|----------------------------|
|                      |                    | Typical   |      |                    | Initial Values                  | Values After Testing |                            |
|                      | BLM21BB151SN1D     | 150 $\pm$ 25%   | 150  | 600                | 0.21                            | 0.31                 | For high speed signal line |
|                      | BLM21BB151SN1B     |   |      |                    |                                 |                      |                            |
|                      | BLM21BD151SN1D     | 150 $\pm$ 25%   | 150  | 350                | 0.25                            | 0.35                 |                            |
|                      | BLM21BD151SN1B     |   |      |                    |                                 |                      |                            |
|                      | BLM21BB201SN1D     | 200 $\pm$ 25%   | 200  | 500                | 0.26                            | 0.36                 |                            |
|                      | BLM21BB201SN1B     |   |      |                    |                                 |                      |                            |
|                      | BLM21BB221SN1D     | 220 $\pm$ 25%   | 220  | 500                | 0.26                            | 0.36                 |                            |
|                      | BLM21BB221SN1B     |   |      |                    |                                 |                      |                            |
|                      | BLM21BD221SN1D     | 220 $\pm$ 25%   | 220  | 350                | 0.25                            | 0.35                 |                            |
|                      | BLM21BD221SN1B     |   |      |                    |                                 |                      |                            |
|                      | BLM21BB331SN1D     | 330 $\pm$ 25%   | 330  | 400                | 0.33                            | 0.43                 |                            |
|                      | BLM21BB331SN1B     |   |      |                    |                                 |                      |                            |
|                      | BLM21BD331SN1D     | 330 $\pm$ 25%   | 330  | 300                | 0.3                             | 0.4                  |                            |
|                      | BLM21BD331SN1B     |   |      |                    |                                 |                      |                            |
|                      | BLM21BD421SN1D     | 420 $\pm$ 25%   | 420  | 300                | 0.3                             | 0.4                  |                            |
|                      | BLM21BD421SN1B     |   |      |                    |                                 |                      |                            |
|                      | BLM21BB471SN1D     | 470 $\pm$ 25%   | 470  | 400                | 0.40                            | 0.50                 |                            |
|                      | BLM21BB471SN1B     |   |      |                    |                                 |                      |                            |
|                      | BLM21BD471SN1D     | 470 $\pm$ 25%   | 470  | 300                | 0.35                            | 0.45                 |                            |
|                      | BLM21BD471SN1B     |   |      |                    |                                 |                      |                            |
|                      | BLM21BD601SN1D     | 600 $\pm$ 25%   | 600  | 300                | 0.35                            | 0.45                 |                            |
|                      | BLM21BD601SN1B     |   |      |                    |                                 |                      |                            |
|                      | BLM21BD751SN1D     | 750 $\pm$ 25%   | 750  | 250                | 0.4                             | 0.5                  |                            |
|                      | BLM21BD751SN1B     |   |      |                    |                                 |                      |                            |
|                      | BLM21BD102SN1D     | 1000 $\pm$ 25%  | 1000 | 250                | 0.4                             | 0.5                  |                            |
|                      | BLM21BD102SN1B     |   |      |                    |                                 |                      |                            |
|                      | BLM21BD152SN1D     | 1500 $\pm$ 25%  | 1500 | 250                | 0.45                            | 0.55                 |                            |
|                      | BLM21BD152SN1B     |   |      |                    |                                 |                      |                            |
|                      | BLM21BD182SN1D     | 1800 $\pm$ 25%  | 1800 | 250                | 0.5                             | 0.6                  |                            |
|                      | BLM21BD182SN1B     |   |      |                    |                                 |                      |                            |
|                      | BLM21BD222SN1L     | 1600 min.   | 2250 | 250                | 0.6                             | 0.7                  |                            |
|                      | BLM21BD222SN1B     |   |      |                    |                                 |                      |                            |
|                      | BLM21BD222TN1D     | 2200 $\pm$ 25%  | 2200 | 200                | 0.6                             | 0.7                  |                            |
|                      | BLM21BD222TN1B     |   |      |                    |                                 |                      |                            |
|                      | BLM21BD272SN1L     | 2700 $\pm$ 25%  | 2700 | 200                | 0.8                             | 0.9                  |                            |
|                      | BLM21BD272SN1B     |   |      |                    |                                 |                      |                            |
|                      | BLM21AG121SN1D     | 120 $\pm$ 25%   | 120  | 1000               | 0.09                            | 0.19                 | For general use            |
|                      | BLM21AG121SN1B     |   |      |                    |                                 |                      |                            |
|                      | BLM21AG151SN1D     | 150 $\pm$ 25%   | 150  | 1000               | 0.09                            | 0.19                 |                            |
|                      | BLM21AG151SN1B     |   |      |                    |                                 |                      |                            |
|                      | BLM21AG221SN1D     | 220 $\pm$ 25%   | 220  | 900                | 0.12                            | 0.22                 |                            |
|                      | BLM21AG221SN1B     |   |      |                    |                                 |                      |                            |
|                      | BLM21AG331SN1D     | 330 $\pm$ 25%   | 330  | 800                | 0.15                            | 0.25                 |                            |
|                      | BLM21AG331SN1B     |   |      |                    |                                 |                      |                            |
|                      | BLM21AG471SN1D     | 470 $\pm$ 25%   | 470  | 700                | 0.18                            | 0.28                 |                            |
|                      | BLM21AG471SN1B     |   |      |                    |                                 |                      |                            |
|                      | BLM21AG601SN1D     | 600 $\pm$ 25%   | 600  | 700                | 0.2                             | 0.3                  |                            |
|                      | BLM21AG601SN1B     |   |      |                    |                                 |                      |                            |
|                      | BLM21AG102SN1D     | 1000 $\pm$ 25%  | 1000 | 600                | 0.27                            | 0.37                 |                            |
|                      | BLM21AG102SN1B     |   |      |                    |                                 |                      |                            |

• Operating Temperature : -55°C to +125°C

• Storage Temperature : -55°C to +125°C

(Note)As for Rated current marked with \*1,  
Rated Current is derated as right figure  
depending on the operating temperature.

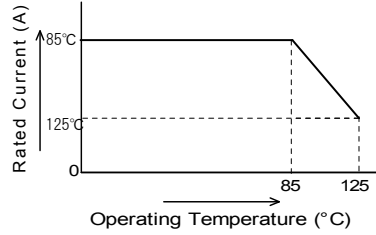

### 4. Style and Dimensions

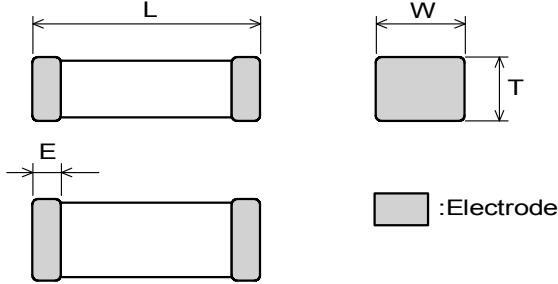

| L       | W        | T  | E                          |
|---------|----------|--|----------------------------|
| 2.0±0.2 | 1.25±0.2 | 0.85±0.2                                   | 0.5±0.2                    |
|         |          | for 21BD222SN1□<br>21BD272SN1□<br>1.25±0.2 |                            |
|         |          |  | for 21BD272SN1□<br>0.3±0.2 |

(in mm)

#### ■ Equivalent Circuit



( Resistance element becomes dominant at high frequencies. )

#### ■ Unit Mass (Typical value)

0.010g

0.014g ( for 21BD222SN1□/21BD272SN1□ )

### 5. Marking

No marking.

### 6. Standard Testing Conditions

< Unless otherwise specified >

Temperature : Ordinary Temp. ( 15 °C to 35 °C )

Humidity : Ordinary Humidity ( 25%(RH) to 85%(RH) )

< In case of doubt >

Temperature : 20°C±2 °C

Humidity : 60%(RH) to 70%(RH)

Atmospheric pressure : 86kPa to 106kPa

### 7. Specifications

#### 7-1. Electrical Performance

| No.   | Item          | Specification | Test Method   |
|-------|---------------|---------------|---|
| 7-1-1 | Impedance     | Meet item 3.  | Measuring Frequency : 100MHz±1MHz<br>Measuring Equipment : Agilent4291A or the equivalent<br>Test Fixture : Agilent16192A or the equivalent |
| 7-1-2 | DC Resistance | Meet item 3.  | Measuring Equipment : Digital multi meter<br>* Except resistance of the Substrate and Wire  |

#### 7-2. Mechanical Performance

| No.                          | Item                      | Specification  | Test Method   |           |                              |             |               |              |   |
|------------------------------|---------------------------|--|---|-----------|------------------------------|-------------|---------------|--------------|---|
| 7-2-1                        | Appearance and Dimensions | Meet item 4.   | Visual Inspection and measured with Slide Calipers. |           |                              |             |               |              |   |
| 7-2-2                        | Bonding Strength          | Meet Table 1.<br><br><table border="1" style="margin-left: 20px;"> <caption>Table 1</caption> <thead> <tr> <th>Appearance</th> <th>No damage</th> </tr> </thead> <tbody> <tr> <td>Impedance Change (at 100MHz)</td> <td>Within ±30%</td> </tr> <tr> <td>DC Resistance</td> <td>Meet item 3.</td> </tr> </tbody> </table> | Appearance  | No damage | Impedance Change (at 100MHz) | Within ±30% | DC Resistance | Meet item 3. | It shall be soldered on the substrate.<br>Applying Force(F) : 9.8N<br>Applying Time : 5s±1s<br>Applied direction: Parallel to substrate<br><br> |
| Appearance                   | No damage                 |  |   |           |                              |             |               |              |   |
| Impedance Change (at 100MHz) | Within ±30%               |  |   |           |                              |             |               |              |   |
| DC Resistance                | Meet item 3.              |  |   |           |                              |             |               |              |   |

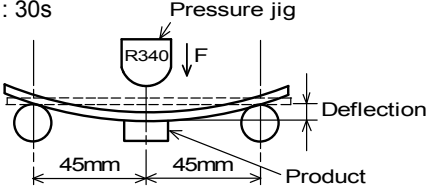
| No.                          | Item                                     | Specification   | Test Method   |           |                              |  |               |              |  |
|------------------------------|--|---|---|-----------|------------------------------|--|---------------|--------------|--|
| 7-2-3                        | Bending Strength                         | Meet Table 1.   | <p>It shall be soldered on the substrate.<br/>Substrate: Glass-epoxy 100mm×40mm×1.6mm<br/>Deflection: 1.0mm<br/>Speed of Applying Force : 0.5mm/s<br/>Keeping Time : 30s</p>  |           |                              |  |               |              |  |
| 7-2-4                        | Vibration                                |   | <p>It shall be soldered on the substrate.<br/>Oscillation Frequency : 10Hz to 55Hz to 10Hz for 1 min<br/>Total Amplitude : 1.5mm<br/>Testing Time : A period of 2 hours in each of 3 mutually perpendicular directions. (Total 6 h)</p>                         |           |                              |  |               |              |  |
| 7-2-5                        | Resistance to Soldering Heat             | <p>Meet Table 2.</p> <table border="1" data-bbox="427 779 758 981"> <caption>Table 2</caption> <tr> <td>Appearance</td> <td>No damage</td> </tr> <tr> <td>Impedance Change (at 100MHz)</td> <td>Within ±30% (for BLM21SN)<br/>Within ±50%</td> </tr> <tr> <td>DC Resistance</td> <td>Meet item 3.</td> </tr> </table> | Appearance  | No damage | Impedance Change (at 100MHz) | Within ±30% (for BLM21SN)<br>Within ±50% | DC Resistance | Meet item 3. | <p>Pre-Heating : 150°C±10°C, 60s~90s<br/>Solder : Sn-3.0Ag-0.5Cu<br/>Solder Temperature : 270°C±5°C<br/>Immersion Time : 10s±0.5s<br/>Immersion and emersion rates : 25mm/s<br/>Then measured after exposure in the room condition for 48h±4h.</p> |
| Appearance                   | No damage                                |   |   |           |                              |  |               |              |  |
| Impedance Change (at 100MHz) | Within ±30% (for BLM21SN)<br>Within ±50% |   |   |           |                              |  |               |              |  |
| DC Resistance                | Meet item 3.                             |   |   |           |                              |  |               |              |  |
| 7-2-6                        | Drop                                     | Products shall be no failure after tested.  | <p>It shall be dropped on concrete or steel board.<br/>Method : free fall<br/>Height : 75cm<br/>Attitude from which the product is dropped : 3 direction<br/>The number of times : 3 times for each direction(Total 9 times)</p>                                |           |                              |  |               |              |  |
| 7-2-7                        | Solderability                            | The electrodes shall be at least 95% covered with new solder coating.   | <p>Flux : Ethanol solution of rosin,25(wt)%<br/>Pre-Heating : 150°C±10°C, 60s~90s<br/>Solder : Sn-3.0Ag-0.5Cu<br/>Solder Temperature : 240°C±5°C<br/>Immersion Time : 4s±1s<br/>Immersion and emersion rates : 25mm/s</p>                                       |           |                              |  |               |              |  |

**7-3. Environmental Performance**

It shall be soldered on the substrate.

| No.   | Item              | Specification | Test Method  |
|-------|-------------------|---------------|--|
| 7-3-1 | Temperature Cycle | Meet Table 2. | <p>1 cycle : 1 step : -55 °C(+0 °C,-3 °C) / 30min±3min<br/>2 step : Ordinary temp. / 10min to 15min<br/>3 step : +125 °C(+3 °C,-0 °C) / 30min±3min<br/>4 step : Ordinary temp. / 10min to 15min<br/>Total of 100 cycles<br/>Then measured after exposure in the room condition for 48h±4h.</p> |
| 7-3-2 | Humidity          |               | <p>Temperature : 40°C±2°C<br/>Humidity : 90%(RH) to 95%(RH)<br/>Time : 1000h(+48h,-0h)<br/>Then measured after exposure in the room condition for 48h±4h.</p>  |
| 7-3-3 | Heat Life         |               | <p>Temperature : 125°C±3°C<br/>(in case of Rated current is more than 1A,<br/>do the test at : +85 °C±3°C)<br/>Applying Current : Rated Current<br/>Time : 1000h(+48h,-0h)<br/>Then measured after exposure in the room condition for 48h±4h.</p>  |
| 7-3-4 | Cold Resistance   |               | <p>Temperature : -55°C±2°C<br/>Time : 1000h(+48h,-0h)<br/>Then measured after exposure in the room condition for 48h±4h.</p>   |

## 8. Specification of Packaging

### 8-1. Appearance and Dimensions

| Part Number                                       | Type                        | Appearance and Dimensions |  |
|---|-----------------------------|---------------------------|--|
|   |                             | a                         |  |
| BLM21<br>except<br>( 21BD222SN1L<br>21BD272SN1L ) | 8mm-wide<br>Paper<br>tape   | 1.1<br>max.               |  |
| BLM21BD222SN1L<br>BLM21BD272SN1L                  | 8mm-wide<br>Plastic<br>tape | 1.3<br>±0.1               |  |

\*Dimension of the Cavity is measured at the bottom side.

(in mm)

|                           | Paper tape  | Plastic tape  |
|---------------------------|---|---|
| Taping                    | Products shall be packaged in the cavity of the base tape of 8mm-wide, 4mm-pitch continuously and sealed by top tape and bottom tape.                         | Products shall be packaged in the each embossed cavity of 8mm-wide, 4mm-pitch plastic tape continuously and sealed by cover tape. |
| Sprocket hole             | The sprocket holes are to the right as the tape is pulled toward the user.  |   |
| Spliced point             | The base tape and top tape have no spliced point.   | The cover tape has no spliced point.  |
| Cavity                    | There shall not be burr in the cavity.  | —   |
| Missing components number | Missing components number within 0.1% of the number per reel or 1 pc., whichever is greater, and are not continuous. The specified quantity per reel is kept. |   |

### 8-2. Tape Strength

#### (1) Pull Strength

|              |              |          |
|--------------|--------------|----------|
| Paper tape   | Top tape     | 5N min.  |
|              | Bottom tape  |          |
| Plastic tape | Plastic tape | 5N min.  |
|              | Cover tape   | 10N min. |

#### (2) Peeling off force of Top tape · Cover tape

|                      |              |              |
|----------------------|--------------|--------------|
| Speed of Peeling off | 300mm/min    |              |
| Peeling off force *  | Paper tape   | 0.1N to 0.6N |
|                      | Plastic tape | 0.2N to 0.7N |

\* Minimum value is typical.

#### • Case of Paper tape

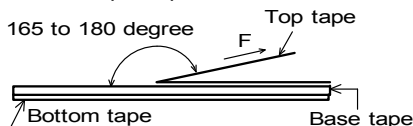

#### • Case of Plastic tape

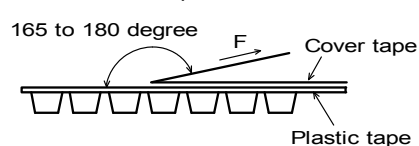



**8-3. Taping Condition**

(1) Standard quantity per reel

| Type                                  | Quantity per 180mm reel |
|---------------------------------------|-------------------------|
| BLM21(except 21BD222SN1L/21BD272SN1L) | 4000 pcs. / reel        |
| BLM21BD222SN1L/BLM21BD272SN1L         | 3000 pcs. / reel        |

(2) There shall be leader-tape (cover tape/top tape and empty tape ) and trailer- tape(empty tape) as follows.

(3) On paper tape, the top tape and the base tape shall not be adhered at the tip of the empty leader tape for more than 5 pitch.

(4) Marking for reel

The following items shall be marked on a label and the label is stuck on the reel.

(Customer part number, MURATA part number, Inspection number(\*1) , RoHS marking(\*2), Quantity, etc)

\*1) « Expression of Inspection No. » □□ 0000 xxx  
(1) (2) (3)

(1) Factory Code

(2) Date

First digit : Year / Last digit of year

Second digit : Month / Jan. to Sep. → 1 to 9, Oct. to Dec. → O, N, D

Third, Fourth digit : Day

(3) Serial No.

\*2) « Expression of RoHS marking » ROHS - Y (△)  
(1) (2)

(1) RoHS regulation conformity parts.

(2) MURATA classification number

(5) Outside package

These reels shall be packed in the corrugated cardboard package and the following items shall be marked on a label and the label is stuck on the box.

(Customer name, Purchasing order number, Customer part number, MURATA part number, RoHS marking (\*2) ,Quantity, etc)

(6) Dimensions of reel and taping(leader-tape, trailer-tape)

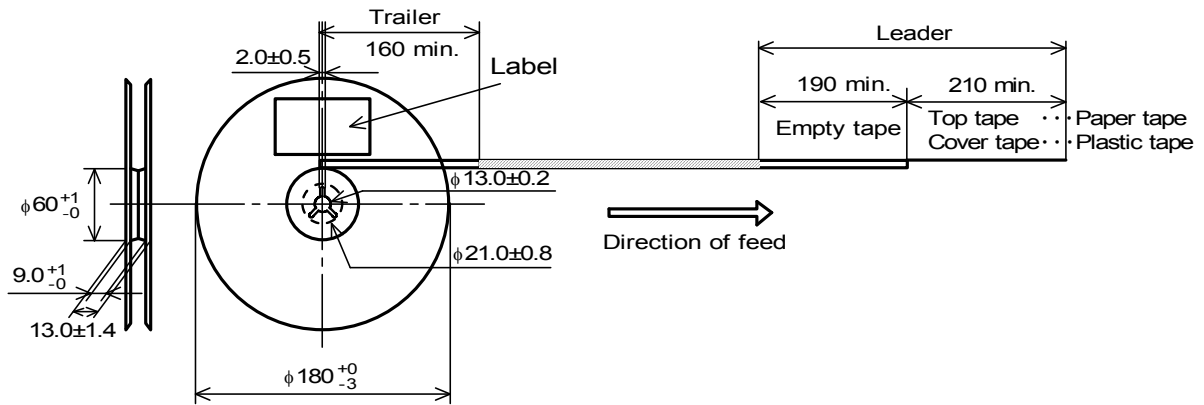

(in mm)

**8-4. Specification of Outer Case**

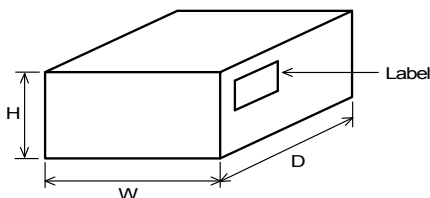

| Outer Case Dimensions (mm) |     |    | Standard Reel Quantity in Outer Case (Reel) |
|----------------------------|-----|----|---|
| W                          | D   | H  |   |
| 186                        | 186 | 93 | 5   |

\* Above Outer Case size is typical. It depends on a quantity of an order.

## 9. ⚠ Caution

### 9-1. Surge current

Excessive surge current (pulse current or rush current) than specified rated current applied to the product may cause a critical failure, such as an open circuit, burnout caused by excessive temperature rise.

Please contact us in advance in case of applying the surge current.

### 9-2. Limitation of Applications

Please contact us before using our products for the applications listed below which require especially high reliability for the prevention of defects which might directly cause damage to the third party's life, body or property.

- |                                   |   |
|-----------------------------------|---|
| (1) Aircraft equipment            | (6) Disaster prevention / crime prevention equipment  |
| (2) Aerospace equipment           | (7) Traffic signal equipment  |
| (3) Undersea equipment            | (8) Transportation equipment (vehicles, trains, ships, etc.)  |
| (4) Power plant control equipment | (9) Applications of similar complexity and /or reliability requirements to the applications listed in the above |
| (5) Medical equipment             |   |

## 10. Notice

This product is designed for solder mounting.

Please consult us in advance for applying other mounting method such as conductive adhesive.

### 10-1. Land pattern designing

- Standard land dimensions

< BLM21 series(except BLM21PG/BLM21SN type) >

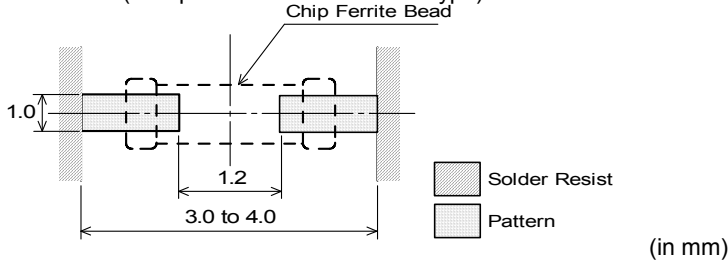

< For BLM21PG/BLM21SN type >

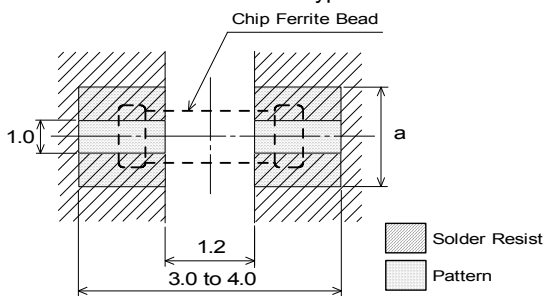

| Type    | Rated Current (A) | Land pad thickness and dimension a |      |      |
|---------|-------------------|------------------------------------|------|------|
|         |                   | 18μm                               | 35μm | 70μm |
| BLM21PG | 1.5               | 1.0                                | 1.0  | 1.0  |
|         | 2                 | 1.2                                | 1.0  | 1.0  |
|         | 3~4               | 2.4                                | 1.2  | 1.0  |
|         | 6                 | 6.4                                | 3.3  | 1.65 |
| BLM21SN | 6~8.5             | -                                  | 6.8  | 3.4  |

(in mm)

\*The excessive heat by land pads may cause deterioration at joint of products with substrate.

### 10-2. Soldering Conditions

Products can be applied to reflow and flow soldering.

#### (1) Flux, Solder

|        |  |
|--------|--|
| Flux   | Use rosin-based flux, but not highly acidic flux (with chlorine content exceeding 0.2(wt)%.)<br>Do not use water-soluble flux. |
| Solder | Use Sn-3.0Ag-0.5Cu solder<br>Standard thickness of solder paste : 100 μm to 200 μm   |

#### (2) Soldering conditions

- Pre-heating should be in such a way that the temperature difference between solder and ferrite surface is limited to 150°C max. Also cooling into solvent after soldering should be in such a way that the temperature difference is limited to 100°C max.

Insufficient pre-heating may cause cracks on the ferrite, resulting in the deterioration of product quality.

- Standard soldering profile and the limit soldering profile is as follows.

The excessive limit soldering conditions may cause leaching of the electrode and / or resulting in the deterioration of product quality.



(3) soldering profile

Flow soldering profile

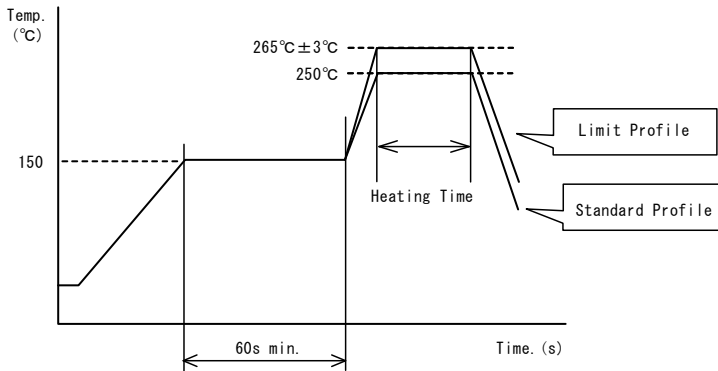

|               | Standard Profile | Limit Profile     |
|---------------|------------------|-------------------|
| Pre-heating   | 150°C、60s min.   |                   |
| Heating       | 250°C、4~6s       | 265°C±3°C、5s max. |
| Cycle of flow | 2 times          | 2 times           |

Reflow soldering profile

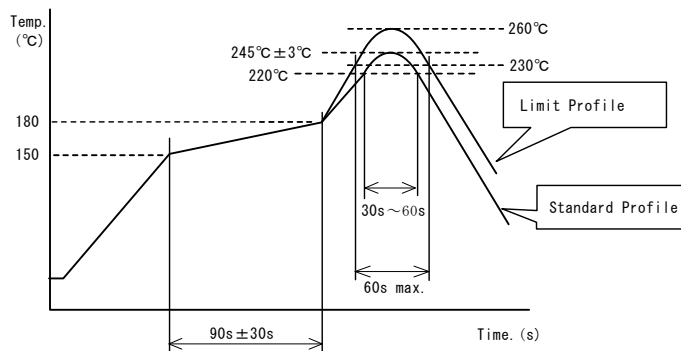

|                  | Standard Profile    | Limit Profile        |
|------------------|---------------------|----------------------|
| Pre-heating      | 150~180°C、90s ± 30s |                      |
| Heating          | above 220°C、30s~60s | above 230°C、60s max. |
| Peak temperature | 245 ± 3°C           | 260°C、10s            |
| Cycle of reflow  | 2 times             | 2 times              |

**10-3. Reworking with soldering iron**

- Pre-heating: 150°C, 1 min
- Tip temperature: 350°C max.
- Soldering time : 3(+1,-0) seconds.
- Soldering iron output: 80W max.
- Tip diameter: φ 3mm max.
- Times : 2times max.

Note :Do not directly touch the products with the tip of the soldering iron in order to prevent the crack on the ferrite material due to the thermal shock.

**10-4. Solder Volume**

Solder shall be used not to be exceed as shown below.

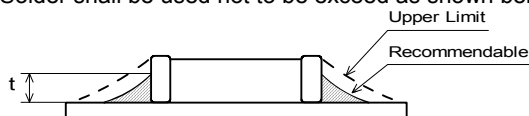

$$1/3T \leq t \leq T$$

(T:Chip thickness)

Accordingly increasing the solder volume, the mechanical stress to product is also increased. Exceeding solder volume may cause the failure of mechanical or electrical performance.

**10-5. Attention regarding P.C.B. bending**

The following shall be considered when designing and laying out P.C.B.'s.

- (1) P.C.B. shall be designed so that products are not subjected to the mechanical stress for board warpage.

<Products direction>

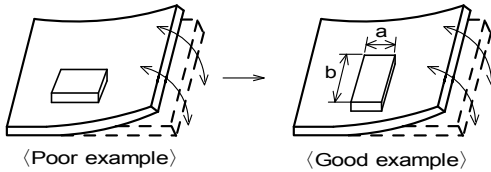

Products shall be located in the sideways direction (Length: $a < b$ ) to the mechanical stress.

- (2) Products location on P.C.B. separation.

Products (A, B, C, D) shall be located carefully so that products are not subject to the mechanical stress due to warping the board. Because they may be subjected the mechanical stress in order of  $A > C > B \cong D$ .

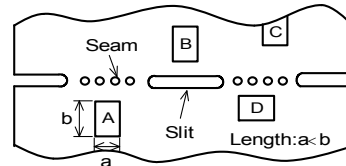
**10-6. Mounting density**

Add special attention to radiating heat of products when mounting the inductor near the products with heating. The excessive heat by other products may cause deterioration at joint of this product with substrate.

**10-7. Operating Environment**

Do not use this product under the following environmental conditions, on deterioration of the Insulation Resistance of the Ferrite material and/or corrosion of Inner Electrode may result from the use.

- (1) in the corrodible atmosphere (acidic gases, alkaline gases, chlorine, sulfur gases, organic gases and etc.)
- (2) in the atmosphere where liquid such as organic solvent, may splash on the products.
- (3) in the atmosphere where the temperature / humidity changes rapidly and it is easy to dew.

**10-8. Resin coating**

The impedance value may change and/or it may affect on the product's performance due to high cure-stress of resin to be used for coating / molding products. So please pay your careful attention when you select resin. In prior to use, please make the reliability evaluation with the product mounted in your application set.

**10-9. Cleaning Conditions**

Products shall be cleaned on the following conditions.

- (1) Cleaning temperature shall be limited to 60°C max. (40°C max. for IPA.)
- (2) Ultrasonic cleaning shall comply with the following conditions, avoiding the resonance phenomenon at the mounted products and P.C.B.  
Power: 20W/ℓ max. Frequency: 28kHz to 40kHz Time: 5 min max.
- (3) Cleaner
  1. Alternative cleaner
    - Isopropyl alcohol (IPA)
  2. Aqueous agent
    - PINE ALPHA ST-100S
- (4) There shall be no residual flux and residual cleaner after cleaning.  
In the case of using aqueous agent, products shall be dried completely after rinse with de-ionized water in order to remove the cleaner.
- (5) Other cleaning  
Please contact us.

**10-10. Handling of a substrate**

After mounting products on a substrate, do not apply any stress to the product caused by bending or twisting to the substrate when cropping the substrate, inserting and removing a connector from the substrate or tightening screw to the substrate.

Excessive mechanical stress may cause cracking in the product.

**10-11 Storage Conditions**

## (1) Storage period

Use the products within 6 months after delivered.

Solderability should be checked if this period is exceeded.

## (2) Storage conditions

- Products should be stored in the warehouse on the following conditions.

Temperature : -10°C to 40°C

Humidity : 15% to 85% relative humidity

No rapid change on temperature and humidity

- Don't keep products in corrosive gases such as sulfur, chlorine gas or acid, or it may cause oxidization of electrode, resulting in poor solderability.
- Products should be stored on the palette for the prevention of the influence from humidity, dust and so on.
- Products should be stored in the warehouse without heat shock, vibration, direct sunlight and so on.
- Products should be stored under the airtight packaged condition.

## (3) Delivery

Care should be taken when transporting or handling product to avoid excessive vibration or mechanical shock.

**11.  Note**

- (1) Please make sure that your product has been evaluated in view of your specifications with our product being mounted to your product.
- (2) You are requested not to use our product deviating from the agreed specifications.
- (3) The contents of this reference specification are subject to change without advance notice. Please approve our product specifications or transact the approval sheet for product specifications before ordering.