



Chipsmall Limited consists of a professional team with an average of over 10 year of expertise in the distribution of electronic components. Based in Hongkong, we have already established firm and mutual-benefit business relationships with customers from,Europe,America and south Asia,supplying obsolete and hard-to-find components to meet their specific needs.

With the principle of "Quality Parts,Customers Priority,Honest Operation,and Considerate Service",our business mainly focus on the distribution of electronic components. Line cards we deal with include Microchip,ALPS,ROHM,Xilinx,Pulse,ON,Everlight and Freescale. Main products comprise IC,Modules,Potentiometer,IC Socket,Relay,Connector.Our parts cover such applications as commercial,industrial, and automotives areas.

We are looking forward to setting up business relationship with you and hope to provide you with the best service and solution. Let us make a better world for our industry!



Contact us

Tel: +86-755-8981 8866 Fax: +86-755-8427 6832

Email & Skype: info@chipsmall.com Web: www.chipsmall.com

Address: A1208, Overseas Decoration Building, #122 Zhenhua RD., Futian, Shenzhen, China



BLP05H675XR; BLP05H675XRG

Power LDMOS transistor

AMMPLION

Rev. 4 — 1 September 2016

Product data sheet

1. Product profile

1.1 General description

A 75 W extremely rugged LDMOS power transistor for broadcast and industrial applications in the HF to 600 MHz band.

Table 1. Application information

Test signal	f	V _{DS}	P _L	G _p	η _D
	(MHz)	(V)	(W)	(dB)	(%)
pulsed RF	108	50	75	27	75

1.2 Features and benefits

- Easy power control
- Integrated double sided ESD protection
- Excellent ruggedness
- High efficiency
- Excellent thermal stability
- Designed for broadband operation (HF to 600 MHz)
- Compliant to Directive 2002/95/EC, regarding Restriction of Hazardous Substances (RoHS)

1.3 Applications

- Industrial, scientific and medical applications
- Broadcast transmitter applications

2. Pinning information

Table 2. Pinning

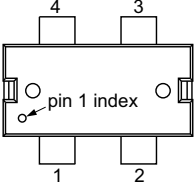
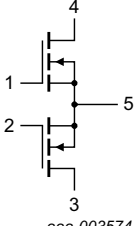
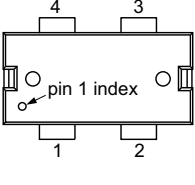
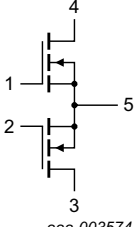
Pin	Description	Simplified outline	Graphic symbol
BLP05H675XR (SOT1223-2)			
1	gate 2		 aaa-003574
2	gate 1		
3	drain 1		
4	drain 2		
5	source ^[1]		
BLP05H675XRG (SOT1224-2)			
1	gate 2		 aaa-003574
2	gate 1		
3	drain 1		
4	drain 2		
5	source ^[1]		

[1] Connected to flange.

3. Ordering information

Table 3. Ordering information

Type number	Package		
	Name	Description	Version
BLP05H675XR	HSOP4F	plastic, heatsink small outline package; 4 leads (flat)	SOT1223-2
BLP05H675XRG	HSOP4F	plastic, heatsink small outline package; 4 leads	SOT1224-2

4. Limiting values

Table 4. Limiting values

In accordance with the Absolute Maximum Rating System (IEC 60134).

Symbol	Parameter	Conditions	Min	Max	Unit
V_{DS}	drain-source voltage		-	135	V
V_{GS}	gate-source voltage		-6	+11	V
T_{stg}	storage temperature		-65	+150	°C
T_j	junction temperature		-	225	°C

[1] Continuous use at maximum temperature will affect the reliability, for details refer to the online MTF calculator.

5. Thermal characteristics

Table 5. Thermal characteristics

Symbol	Parameter	Conditions	Typ	Unit
$R_{th(j-c)}$	thermal resistance from junction to case	$T_j = 115\text{ °C}$ [1][2]	1.09	K/W
$Z_{th(j-c)}$	transient thermal impedance from junction to case	$T_j = 150\text{ °C}$; $t_p = 100\text{ }\mu\text{s}$; $\delta = 20\%$ [3]	0.37	K/W

- [1] T_j is the junction temperature.
- [2] $R_{th(j-c)}$ is measured under RF conditions.
- [3] See [Figure 1](#).

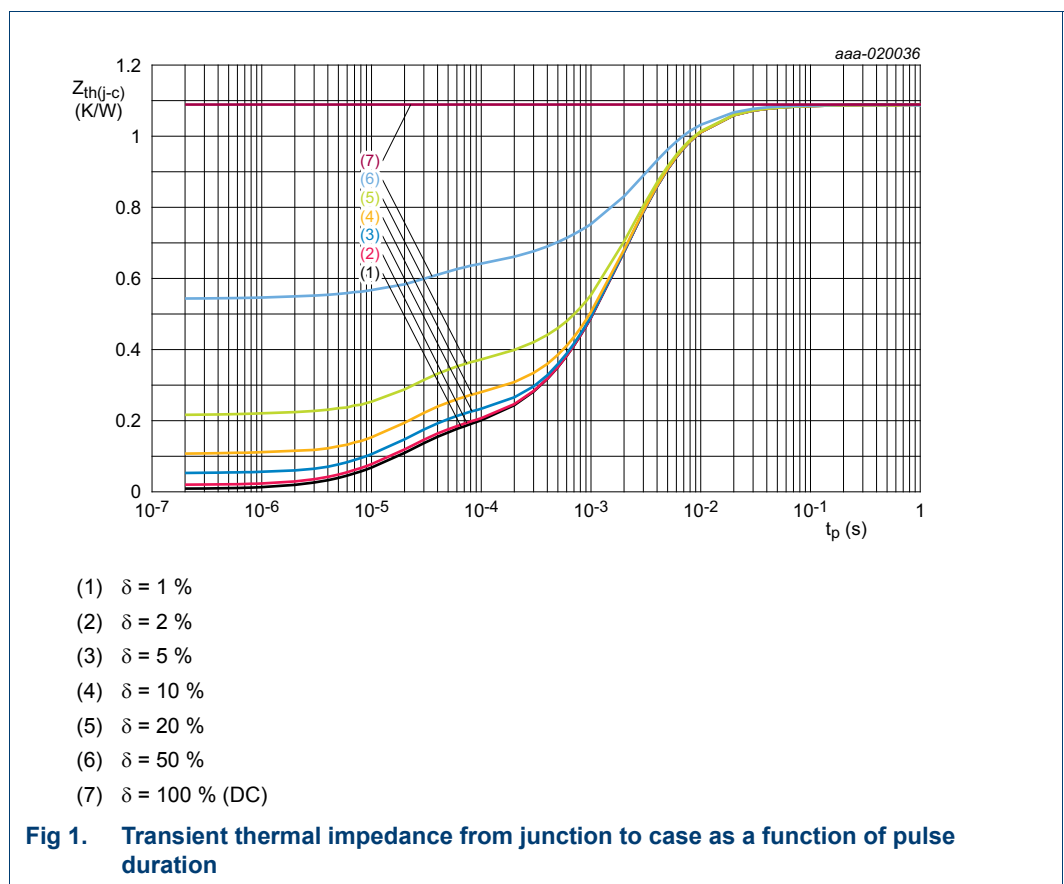

6. Characteristics

Table 6. DC characteristics

$T_j = 25\text{ °C}$; per section unless otherwise specified.

Symbol	Parameter	Conditions	Min	Typ	Max	Unit
$V_{(BR)DSS}$	drain-source breakdown voltage	$V_{GS} = 0\text{ V}$; $I_D = 0.25\text{ mA}$	135	-	-	V
$V_{GS(th)}$	gate-source threshold voltage	$V_{DS} = 10\text{ V}$; $I_D = 25\text{ mA}$	1.25	1.8	2.25	V
V_{GSq}	gate-source quiescent voltage	$V_{DS} = 50\text{ V}$; $I_D = 10\text{ mA}$	-	1.7	-	V
I_{DSS}	drain leakage current	$V_{GS} = 0\text{ V}$; $V_{DS} = 50\text{ V}$	-	-	1.4	μA

Table 6. DC characteristics ...continued
T_j = 25 °C; per section unless otherwise specified.

Symbol	Parameter	Conditions	Min	Typ	Max	Unit
I _{DSX}	drain cut-off current	V _{GS} = V _{GS(th)} + 3.75 V; V _{DS} = 10 V	-	3.6	-	A
I _{GSS}	gate leakage current	V _{GS} = 11 V; V _{DS} = 0 V	-	-	140	nA
R _{DS(on)}	drain-source on-state resistance	V _{GS} = V _{GS(th)} + 3.75 V; I _D = 875 mA	-	1.6	-	Ω

Table 7. AC characteristics
T_j = 25 °C; per section unless otherwise specified.

Symbol	Parameter	Conditions	Min	Typ	Max	Unit
C _{rs}	feedback capacitance	V _{GS} = 0 V; V _{DS} = 50 V; f = 1 MHz	-	0.25	-	pF
C _{iss}	input capacitance	V _{GS} = 0 V; V _{DS} = 50 V; f = 1 MHz	-	31	-	pF
C _{oss}	output capacitance	V _{GS} = 0 V; V _{DS} = 50 V; f = 1 MHz	-	11	-	pF

Table 8. RF characteristics
Test signal: pulsed RF; t_p = 100 μs; δ = 20 %; f = 108 MHz; RF performance at V_{DS} = 50 V; I_{Dq} = 20 mA; T_{case} = 25 °C; unless otherwise specified; in a class-AB production test circuit.

Symbol	Parameter	Conditions	Min	Typ	Max	Unit
G _p	power gain	P _L = 75 W	25.5	27	-	dB
RL _{in}	input return loss	P _L = 75 W	-	-15	-	dB
η _D	drain efficiency	P _L = 75 W	72	75	-	%

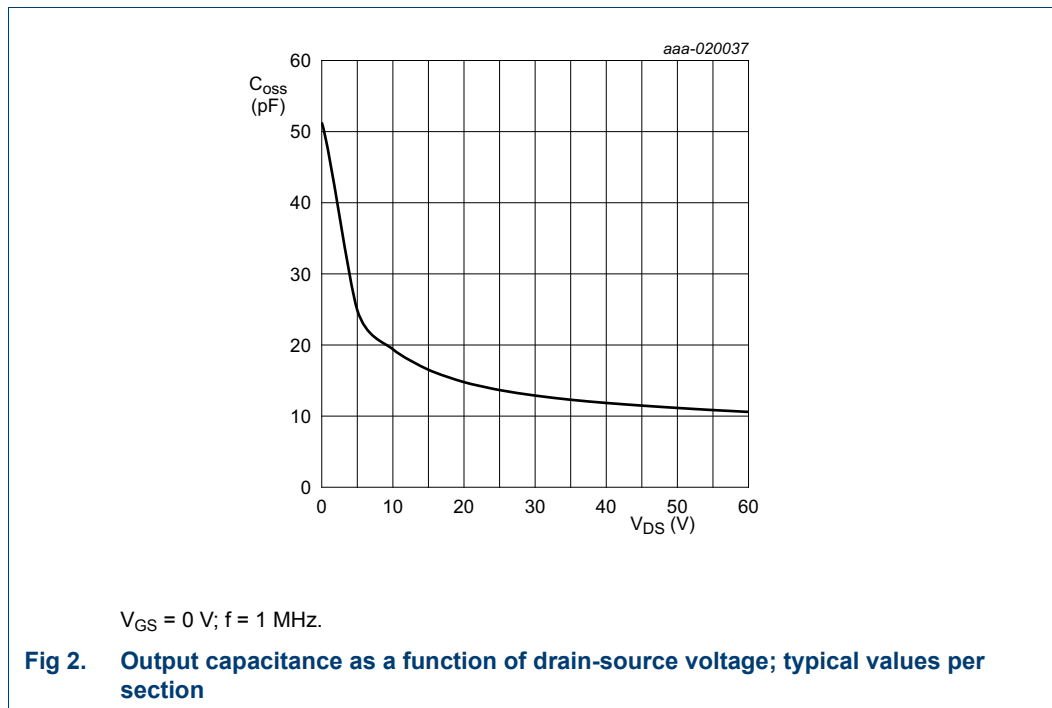

7. Test information

7.1 Ruggedness in class-AB operation

The BLP05H675XR and BLP05H675XRG are capable of withstanding a load mismatch corresponding to VSWR > 65 : 1 through all phases under the following conditions: $V_{DS} = 50\text{ V}$; $I_{Dq} = 20\text{ mA}$; $P_L = 75\text{ W}$ pulsed; $f = 108\text{ MHz}$.

7.2 Impedance information

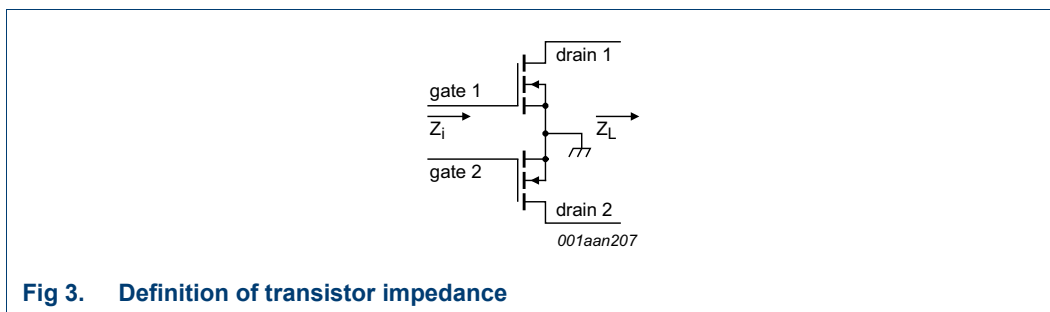

Fig 3. Definition of transistor impedance

Table 9. Typical push-pull impedance

Simulated Z_i and Z_L device impedance; impedance info at $V_{DS} = 50\text{ V}$ and $P_L = 75\text{ W}$.

f	Z_i	Z_L
(MHz)	(Ω)	(Ω)
108	$29.6 - j143.4$	$51.1 + j11.7$

7.3 UIS avalanche energy

Table 10. Typical avalanche data per section

$T_{amb} = 25\text{ }^\circ\text{C}$; typical test data; test jig without water cooling.

I_{AS}	E_{AS}
(A)	(J)
2	0.13
2.5	0.1
3	0.08

For information see application note AN10273.

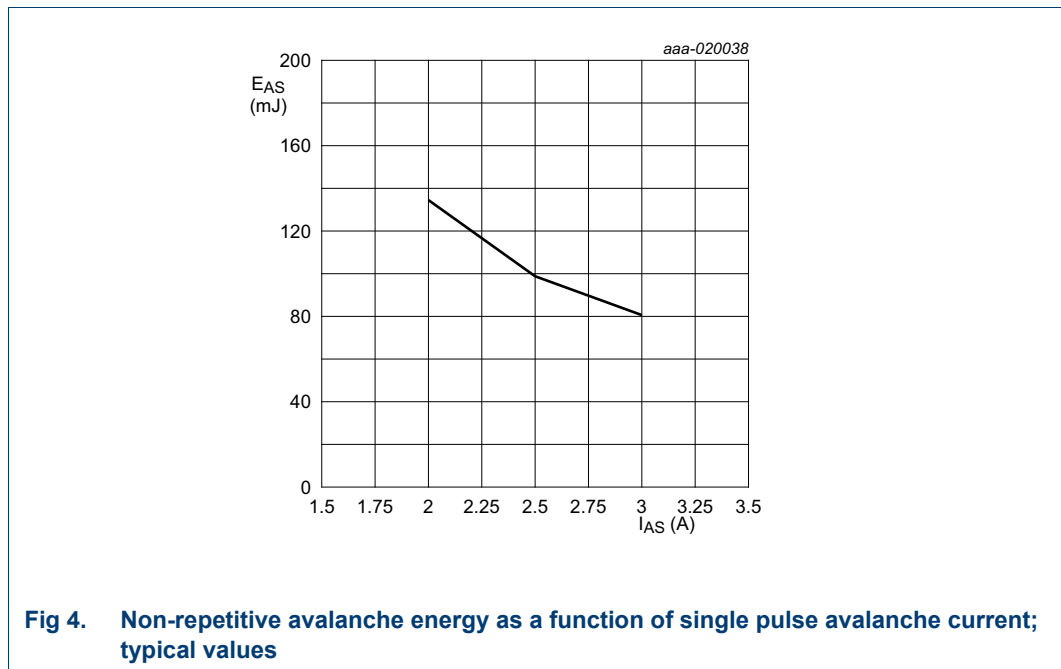

7.4 Test circuit

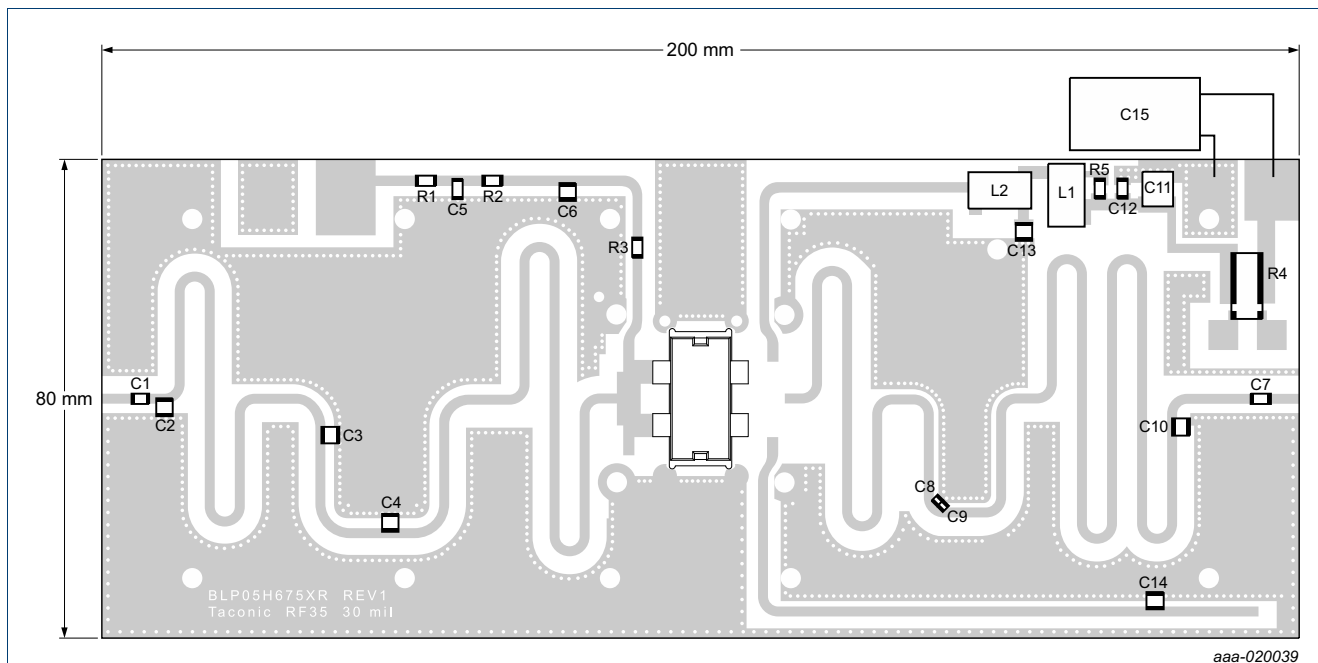

Printed-Circuit Board (PCB): RF-35; $\epsilon_r = 3.5$ F/m; thickness = 0.765 mm; thickness copper plating = 35 μ m.

See [Table 11](#) for a list of components.

Fig 5. Component layout for class-AB production test circuit

Table 11. List of components

For test circuit see [Figure 5](#).

Component	Description	Value	Remarks
C1, C7	multilayer ceramic chip capacitor	470 pF	ATC 800B
C2	multilayer ceramic chip capacitor	82 pF	ATC 800B
C3	multilayer ceramic chip capacitor	270 pF	ATC 800B
C4	multilayer ceramic chip capacitor	22 pF	ATC 800B
C5	multilayer ceramic chip capacitor	1 μ F, 50 V	GRM32RR71H105KA01L
C6, C13	multilayer ceramic chip capacitor	820 pF	ATC 800B
C8, C9	multilayer ceramic chip capacitor	36 pF	ATC 100A
C10	multilayer ceramic chip capacitor	18 pF	ATC 800B
C11	multilayer ceramic chip capacitor	4.7 μ F, 100 V	C5750X7RA475KT/A
C12	multilayer ceramic chip capacitor	100 nF	GRM188R72A104KA35D
C14	multilayer ceramic chip capacitor	15 pF	ATC 800B
C15	electrolytic capacitor	2200 μ F, 63 V	Vishay
L1	wire inductor	169 nH	Coilcraft:132-12SMG
L2	wire inductor	90 nH	Coilcraft:132-9SMG
R1, R2	resistor	10 Ω	SMD 1206

Table 11. List of components ...continued
For test circuit see [Figure 5](#).

Component	Description	Value	Remarks
R3	resistor	4.64 kΩ	SMD 0805
R4	shunt resistor	10 mΩ	Ohmite: FC4L110R010FER
R5	resistor	7.5 Ω, 0.6 W	SMD 1206

7.5 Graphical data

The following figures are measured in a class-AB production test circuit.

7.5.1 1-Tone CW pulsed

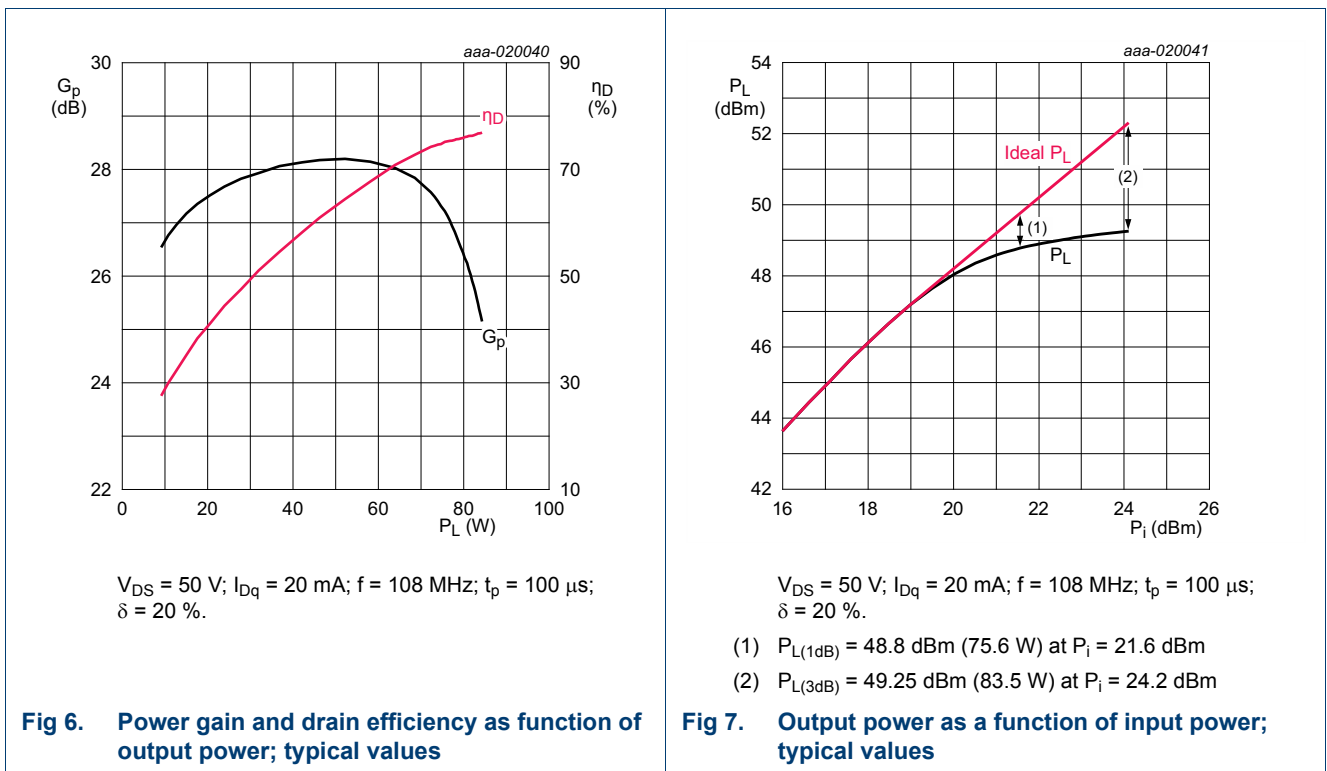

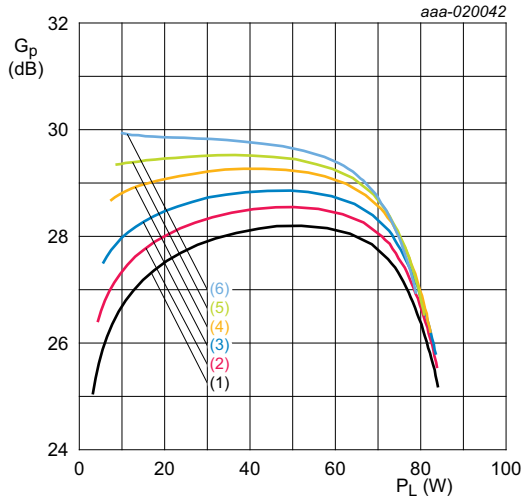

$V_{DS} = 50 \text{ V}; f = 108 \text{ MHz}; t_p = 100 \text{ }\mu\text{s}; \delta = 20 \text{ \%}$.

- (1) $I_{Dq} = 20 \text{ mA}$
- (2) $I_{Dq} = 50 \text{ mA}$
- (3) $I_{Dq} = 100 \text{ mA}$
- (4) $I_{Dq} = 200 \text{ mA}$
- (5) $I_{Dq} = 300 \text{ mA}$
- (6) $I_{Dq} = 400 \text{ mA}$

Fig 8. Power gain as a function of output power; typical values

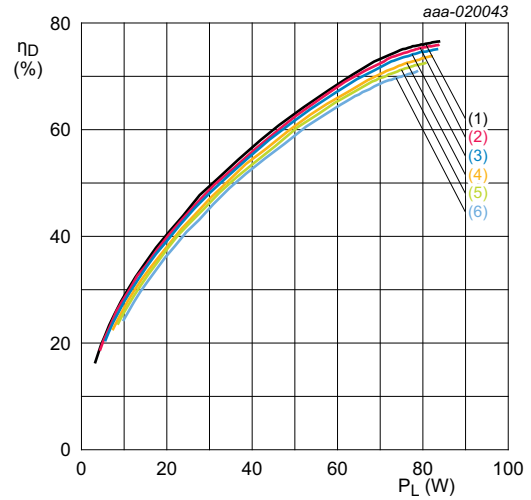

$V_{DS} = 50 \text{ V}; f = 108 \text{ MHz}; t_p = 100 \text{ }\mu\text{s}; \delta = 20 \text{ \%}$.

- (1) $I_{Dq} = 20 \text{ mA}$
- (2) $I_{Dq} = 50 \text{ mA}$
- (3) $I_{Dq} = 100 \text{ mA}$
- (4) $I_{Dq} = 200 \text{ mA}$
- (5) $I_{Dq} = 300 \text{ mA}$
- (6) $I_{Dq} = 400 \text{ mA}$

Fig 9. Drain efficiency as a function of output power; typical values

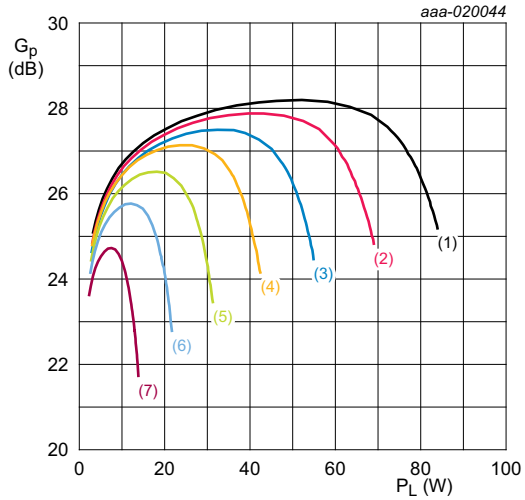

$I_{Dq} = 20 \text{ mA}$; $f = 108 \text{ MHz}$; $t_p = 100 \text{ }\mu\text{s}$; $\delta = 20 \text{ \%}$.

- (1) $V_{DS} = 50 \text{ V}$
- (2) $V_{DS} = 45 \text{ V}$
- (3) $V_{DS} = 40 \text{ V}$
- (4) $V_{DS} = 35 \text{ V}$
- (5) $V_{DS} = 30 \text{ V}$
- (6) $V_{DS} = 25 \text{ V}$
- (7) $V_{DS} = 20 \text{ V}$

Fig 10. Power gain as a function of output power; typical values

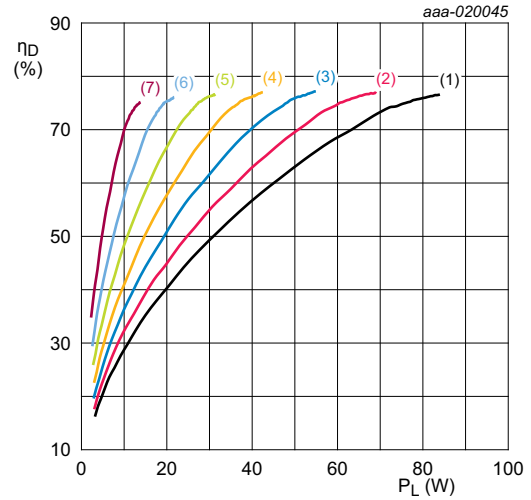

$I_{Dq} = 20 \text{ mA}$; $f = 108 \text{ MHz}$; $t_p = 100 \text{ }\mu\text{s}$; $\delta = 20 \text{ \%}$.

- (1) $V_{DS} = 50 \text{ V}$
- (2) $V_{DS} = 45 \text{ V}$
- (3) $V_{DS} = 40 \text{ V}$
- (4) $V_{DS} = 35 \text{ V}$
- (5) $V_{DS} = 30 \text{ V}$
- (6) $V_{DS} = 25 \text{ V}$
- (7) $V_{DS} = 20 \text{ V}$

Fig 11. Drain efficiency as a function of output power; typical values

8. Package outline

HSOP4F: plastic, heatsink small outline package; 4 leads(flat)

SOT1223-2

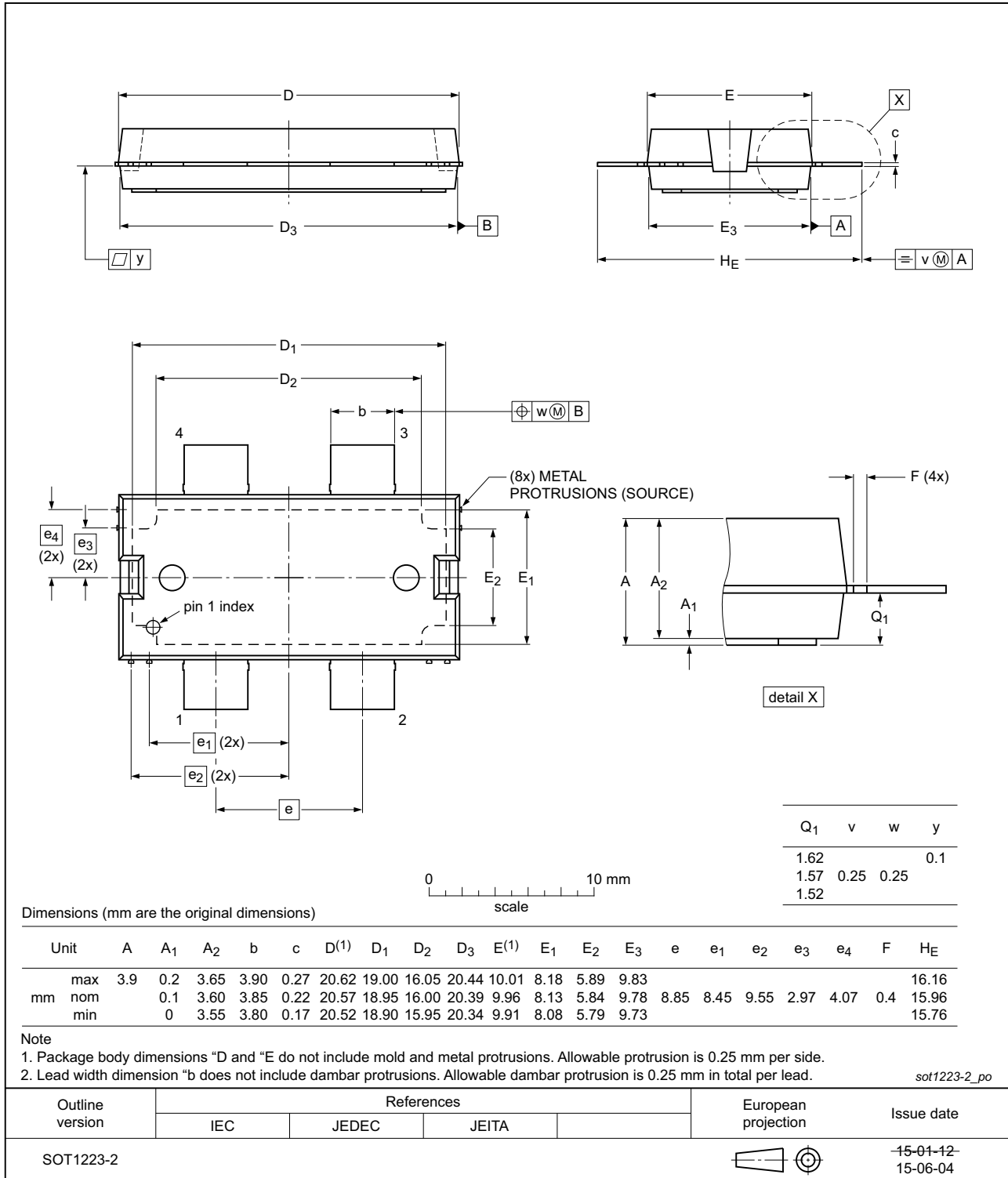

Fig 12. Package outline SOT1223-2 (HSOP4F)

HSOP4: plastic, heatsink small outline package; 4 leads

SOT1224-2

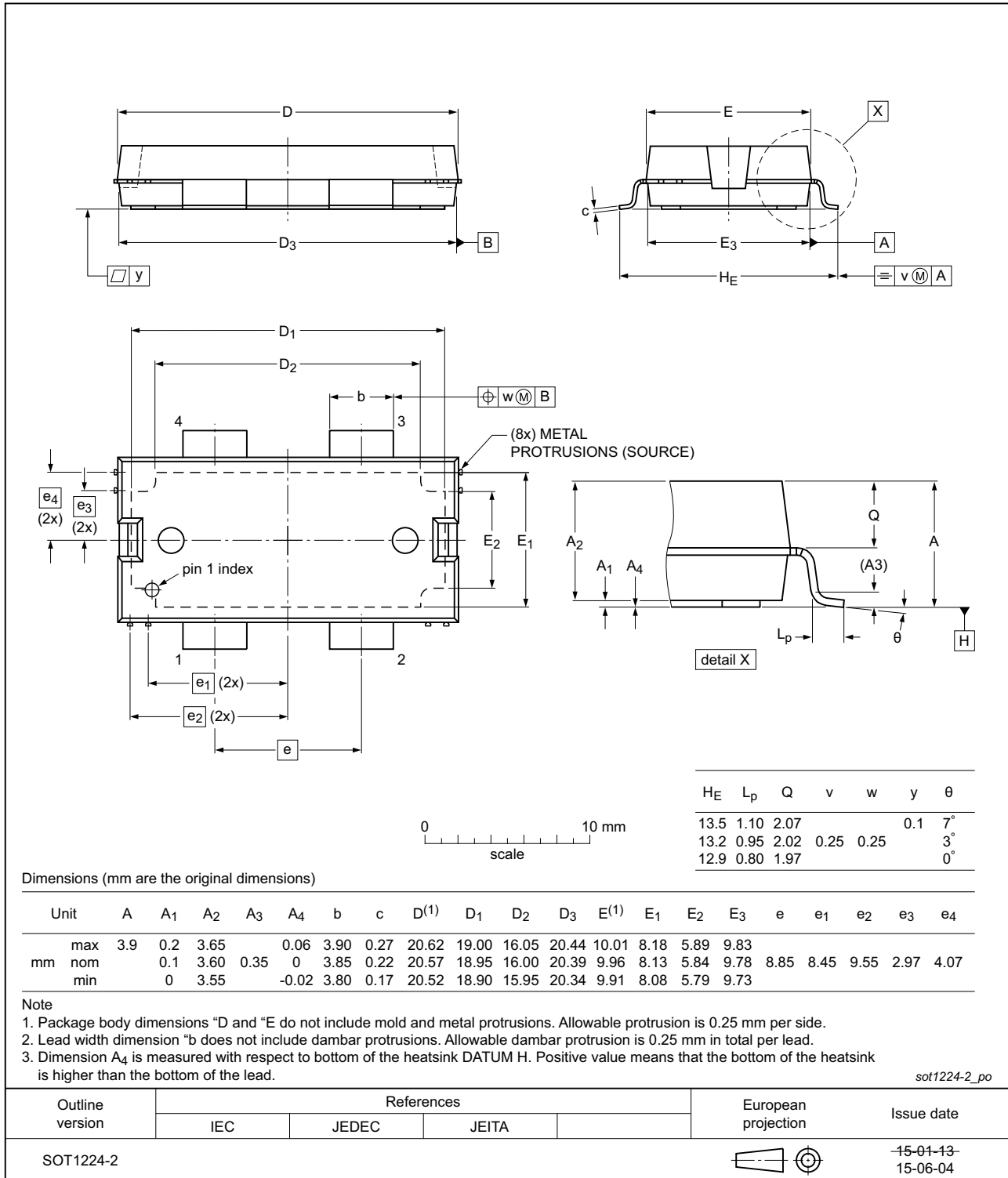



Fig 13. Package outline SOT1224-2 (HSOP4F)

9. Handling information

CAUTION	
	<p>This device is sensitive to ElectroStatic Discharge (ESD). Observe precautions for handling electrostatic sensitive devices.</p> <p>Such precautions are described in the <i>ANSI/ESD S20.20</i>, <i>IEC/ST 61340-5</i>, <i>JESD625-A</i> or equivalent standards.</p>

10. Abbreviations

Table 12. Abbreviations

Acronym	Description
CW	Continuous Wave
ESD	ElectroStatic Discharge
HF	High Frequency
LDMOS	Laterally Diffused Metal-Oxide Semiconductor
MTF	Median Time to Failure
SMD	Surface Mounted Device
UIS	Unclamped Inductive Switching
VSWR	Voltage Standing-Wave Ratio

11. Revision history

Table 13. Revision history

Document ID	Release date	Data sheet status	Change notice	Supersedes
BLP05H675XR_H675XRG v.4	20160901	Product data sheet	-	BLP05H675XR v.3
Modifications:	<ul style="list-style-type: none"> The document now describes both the straight lead and gull-wing versions of this product: BLP05H675XR and BLP05H675XRG respectively Table 2 on page 2: added BLP05H675XRG data Table 3 on page 2: added BLP05H675XRG data Section 7.1 on page 5: added BLP05H675XRG Figure 13 on page 12: added figure SOT1224-2 			
BLP05H675XR v.3	20160122	Product data sheet	-	BLP05H675XR#2
BLP05H675XR#2	20150901	Objective data sheet	-	BLP05H675XR v.1
BLP05H675XR v.1	20150518	Objective data sheet	-	-

12. Legal information

12.1 Data sheet status

Document status ^{[1][2]}	Product status ^[3]	Definition
Objective [short] data sheet	Development	This document contains data from the objective specification for product development.
Preliminary [short] data sheet	Qualification	This document contains data from the preliminary specification.
Product [short] data sheet	Production	This document contains the product specification.

[1] Please consult the most recently issued document before initiating or completing a design.

[2] The term 'short data sheet' is explained in section "Definitions".

[3] The product status of device(s) described in this document may have changed since this document was published and may differ in case of multiple devices. The latest product status information is available on the Internet at URL <http://www.ampleon.com>.

12.2 Definitions

Draft — The document is a draft version only. The content is still under internal review and subject to formal approval, which may result in modifications or additions. Ampleon does not give any representations or warranties as to the accuracy or completeness of information included herein and shall have no liability for the consequences of use of such information.

Short data sheet — A short data sheet is an extract from a full data sheet with the same product type number(s) and title. A short data sheet is intended for quick reference only and should not be relied upon to contain detailed and full information. For detailed and full information see the relevant full data sheet, which is available on request via the local Ampleon sales office. In case of any inconsistency or conflict with the short data sheet, the full data sheet shall prevail.

Product specification — The information and data provided in a Product data sheet shall define the specification of the product as agreed between Ampleon and its customer, unless Ampleon and customer have explicitly agreed otherwise in writing. In no event however, shall an agreement be valid in which the Ampleon product is deemed to offer functions and qualities beyond those described in the Product data sheet.

12.3 Disclaimers

Limited warranty and liability — Information in this document is believed to be accurate and reliable. However, Ampleon does not give any representations or warranties, expressed or implied, as to the accuracy or completeness of such information and shall have no liability for the consequences of use of such information. Ampleon takes no responsibility for the content in this document if provided by an information source outside of Ampleon.

In no event shall Ampleon be liable for any indirect, incidental, punitive, special or consequential damages (including - without limitation - lost profits, lost savings, business interruption, costs related to the removal or replacement of any products or rework charges) whether or not such damages are based on tort (including negligence), warranty, breach of contract or any other legal theory.

Notwithstanding any damages that customer might incur for any reason whatsoever, Ampleon's aggregate and cumulative liability towards customer for the products described herein shall be limited in accordance with the *Terms and conditions of commercial sale* of Ampleon.

Right to make changes — Ampleon reserves the right to make changes to information published in this document, including without limitation specifications and product descriptions, at any time and without notice. This document supersedes and replaces all information supplied prior to the publication hereof.

Suitability for use — Ampleon products are not designed, authorized or warranted to be suitable for use in life support, life-critical or safety-critical systems or equipment, nor in applications where failure or malfunction of an

Ampleon product can reasonably be expected to result in personal injury, death or severe property or environmental damage. Ampleon and its suppliers accept no liability for inclusion and/or use of Ampleon products in such equipment or applications and therefore such inclusion and/or use is at the customer's own risk.

Applications — Applications that are described herein for any of these products are for illustrative purposes only. Ampleon makes no representation or warranty that such applications will be suitable for the specified use without further testing or modification.

Customers are responsible for the design and operation of their applications and products using Ampleon products, and Ampleon accepts no liability for any assistance with applications or customer product design. It is customer's sole responsibility to determine whether the Ampleon product is suitable and fit for the customer's applications and products planned, as well as for the planned application and use of customer's third party customer(s). Customers should provide appropriate design and operating safeguards to minimize the risks associated with their applications and products.

Ampleon does not accept any liability related to any default, damage, costs or problem which is based on any weakness or default in the customer's applications or products, or the application or use by customer's third party customer(s). Customer is responsible for doing all necessary testing for the customer's applications and products using Ampleon products in order to avoid a default of the applications and the products or of the application or use by customer's third party customer(s). Ampleon does not accept any liability in this respect.

Limiting values — Stress above one or more limiting values (as defined in the Absolute Maximum Ratings System of IEC 60134) will cause permanent damage to the device. Limiting values are stress ratings only and (proper) operation of the device at these or any other conditions above those given in the Recommended operating conditions section (if present) or the Characteristics sections of this document is not warranted. Constant or repeated exposure to limiting values will permanently and irreversibly affect the quality and reliability of the device.

Terms and conditions of commercial sale — Ampleon products are sold subject to the general terms and conditions of commercial sale, as published at <http://www.ampleon.com/terms>, unless otherwise agreed in a valid written individual agreement. In case an individual agreement is concluded only the terms and conditions of the respective agreement shall apply. Ampleon hereby expressly objects to applying the customer's general terms and conditions with regard to the purchase of Ampleon products by customer.

No offer to sell or license — Nothing in this document may be interpreted or construed as an offer to sell products that is open for acceptance or the grant, conveyance or implication of any license under any copyrights, patents or other industrial or intellectual property rights.

Export control — This document as well as the item(s) described herein may be subject to export control regulations. Export might require a prior authorization from competent authorities.

Non-automotive qualified products — Unless this data sheet expressly states that this specific Ampleon product is automotive qualified, the product is not suitable for automotive use. It is neither qualified nor tested in accordance with automotive testing or application requirements. Ampleon accepts no liability for inclusion and/or use of non-automotive qualified products in automotive equipment or applications.

In the event that customer uses the product for design-in and use in automotive applications to automotive specifications and standards, customer (a) shall use the product without Ampleon' warranty of the product for such automotive applications, use and specifications, and (b) whenever customer uses the product for automotive applications beyond Ampleon' specifications such use shall be solely at customer's own risk, and (c) customer fully indemnifies Ampleon for any liability, damages or failed product claims resulting from customer design and use of the product for automotive applications beyond Ampleon' standard warranty and Ampleon' product specifications.

Translations — A non-English (translated) version of a document is for reference only. The English version shall prevail in case of any discrepancy between the translated and English versions.

12.4 Trademarks

Notice: All referenced brands, product names, service names and trademarks are the property of their respective owners.

Any reference or use of any 'NXP' trademark in this document or in or on the surface of Ampleon products does not result in any claim, liability or entitlement vis-à-vis the owner of this trademark. Ampleon is no longer part of the NXP group of companies and any reference to or use of the 'NXP' trademarks will be replaced by reference to or use of Ampleon's own trademarks.

13. Contact information

For more information, please visit: <http://www.ampleon.com>

For sales office addresses, please visit: <http://www.ampleon.com/sales>

14. Contents

1 **Product profile** 1

1.1 General description 1

1.2 Features and benefits 1

1.3 Applications 1

2 **Pinning information** 2

3 **Ordering information** 2

4 **Limiting values** 2

5 **Thermal characteristics** 3

6 **Characteristics** 3

7 **Test information** 5

7.1 Ruggedness in class-AB operation 5

7.2 Impedance information 5

7.3 UIS avalanche energy 5

7.4 Test circuit 7

7.5 Graphical data 8

7.5.1 1-Tone CW pulsed 8

8 **Package outline** 11

9 **Handling information** 13

10 **Abbreviations** 13

11 **Revision history** 13

12 **Legal information** 14

12.1 Data sheet status 14

12.2 Definitions 14

12.3 Disclaimers 14

12.4 Trademarks 15

13 **Contact information** 15

14 **Contents** 16

Please be aware that important notices concerning this document and the product(s) described herein, have been included in section 'Legal information'.

© Ampleon Netherlands B.V. 2016. All rights reserved.

For more information, please visit: <http://www.ampleon.com>
 For sales office addresses, please visit: <http://www.ampleon.com/sales>

Date of release: 1 September 2016

Document identifier: BLP05H675XR_H675XRG