



Chipsmall Limited consists of a professional team with an average of over 10 year of expertise in the distribution of electronic components. Based in Hongkong, we have already established firm and mutual-benefit business relationships with customers from,Europe,America and south Asia,supplying obsolete and hard-to-find components to meet their specific needs.

With the principle of “Quality Parts,Customers Priority,Honest Operation,and Considerate Service”,our business mainly focus on the distribution of electronic components. Line cards we deal with include Microchip,ALPS,ROHM,Xilinx,Pulse,ON,Everlight and Freescale. Main products comprise IC,Modules,Potentiometer,IC Socket,Relay,Connector.Our parts cover such applications as commercial,industrial, and automotives areas.

We are looking forward to setting up business relationship with you and hope to provide you with the best service and solution. Let us make a better world for our industry!



Contact us

Tel: +86-755-8981 8866 Fax: +86-755-8427 6832

Email & Skype: info@chipsmall.com Web: www.chipsmall.com

Address: A1208, Overseas Decoration Building, #122 Zhenhua RD., Futian, Shenzhen, China



AC/DC Converter

Isolation Fly-back type PWM method Output 30W 24V Output

BM2P016T Reference Board

BM2P016T-EVK-001

The BM2P016T-EVK-001 evaluation board outputs 24V voltage from the input of 90Vac to 264Vac. The output current supplies rated 1A and up to 1.25A. BM2P016T which is PWM method DC/DC converter IC built-in 650V MOSFET is used.

The BM2P16T contributes to low power consumption by built-in a 650 V starting circuit. Built-in current detection resistor realizes compact power supply design.

Current mode control imposes current limitation on every cycle, providing superior performance in bandwidth and transient response. The switching frequency is 65 kHz in fixed mode. At light load, frequency is reduced and high efficiency is realized. Built-in frequency hopping function contributes to low EMI. Low on-resistance 1.4 Ω 650 V MOSFET built-in contributes to low power consumption and easy design.

The flywheel diode is a fast recovery diode of 6A/200 V RFN6BM2D, contributing to low power consumption.

The conduction / radiation emission test is based on CISPR 22 Class B with best EMI design.

Electronics Characteristics

Not guarantee the characteristics, is representative value.

Unless otherwise noted : $V_{IN} = 230\text{Vac}$, $I_{OUT} = 1\text{A}$, $T_a: 25^\circ\text{C}$

Parameter	Min	Typ	Max	Units	Conditions
Input Voltage Range	85	230	264	Vac	
Input Frequency	47	50/60	63	Hz	
Output Voltage	22.8	24.0	25.2	V	
Maximum Output Power		24		W	
Output Current Range (NOTE1)			(NOTE1) 30	W	$I_{OUT} = 1.25\text{A}$
Stand-by Power	0	1.00	1.25	A	
Efficiency		230		mW	$I_{OUT} = 0\text{A}$
Output Ripple Voltage (NOTE2)		89.5		%	
Operating Temperature Range		163		mVpp	
Input Voltage Range	-10	25	65	$^\circ\text{C}$	

(NOTE1) Please adjust operating time, within any parts surface temperature under 105 $^\circ\text{C}$

(NOTE2) Not include spike noise

Operation Procedure

1. Operation Equipment

- (1) AC Power supply 85Vac~264Vac, over 100W
- (2) Electronic Load capacity 1.25A
- (3) Multi meter

2. Connect method

- (1) AC power supply presetting range 85~264Vac, Output switch is off.
- (2) Load setting under 1.25A. Load switch is off.
- (3) AC power supply N terminal connect to the board AC (N) of CN1, and L terminal connect to AC(L).
- (4) Load + terminal connect to VOUT1, GND terminal connect to GND1 terminal
- (5) AC power meter connect between AC power supply and board.
- (6) Output test equipment connects to output terminal
- (7) AC power supply switch ON.
- (8) Check that output voltage is 24V.
- (9) Electronic load switch ON
- (10) Check output voltage drop by load connect wire resistance



Figure 1. Connection Circuit

Frame Ground (FG)

This evaluation board is provided with a frame ground terminal. The leftmost terminal of CN1 is the frame ground. In addition, the screw hole on the left side of the board is also a frame ground and it is possible to connect to the metal case.

Derating

Maximum Output Power P_o of this reference board is 30W.

The derating curve is shown on the right.

if ambient temperature is over 50°C, please adjust load continuous time by over 105°C of any parts surface temperature.

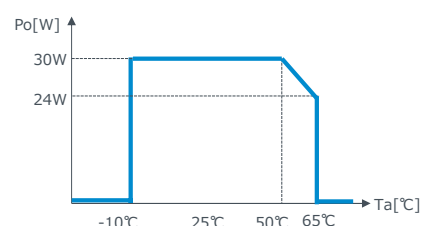

Figure 2. Temperature Derating curve

Schematics

$V_{IN} = 85 \sim 264V_{ac}$, $V_{OUT} = 24V$

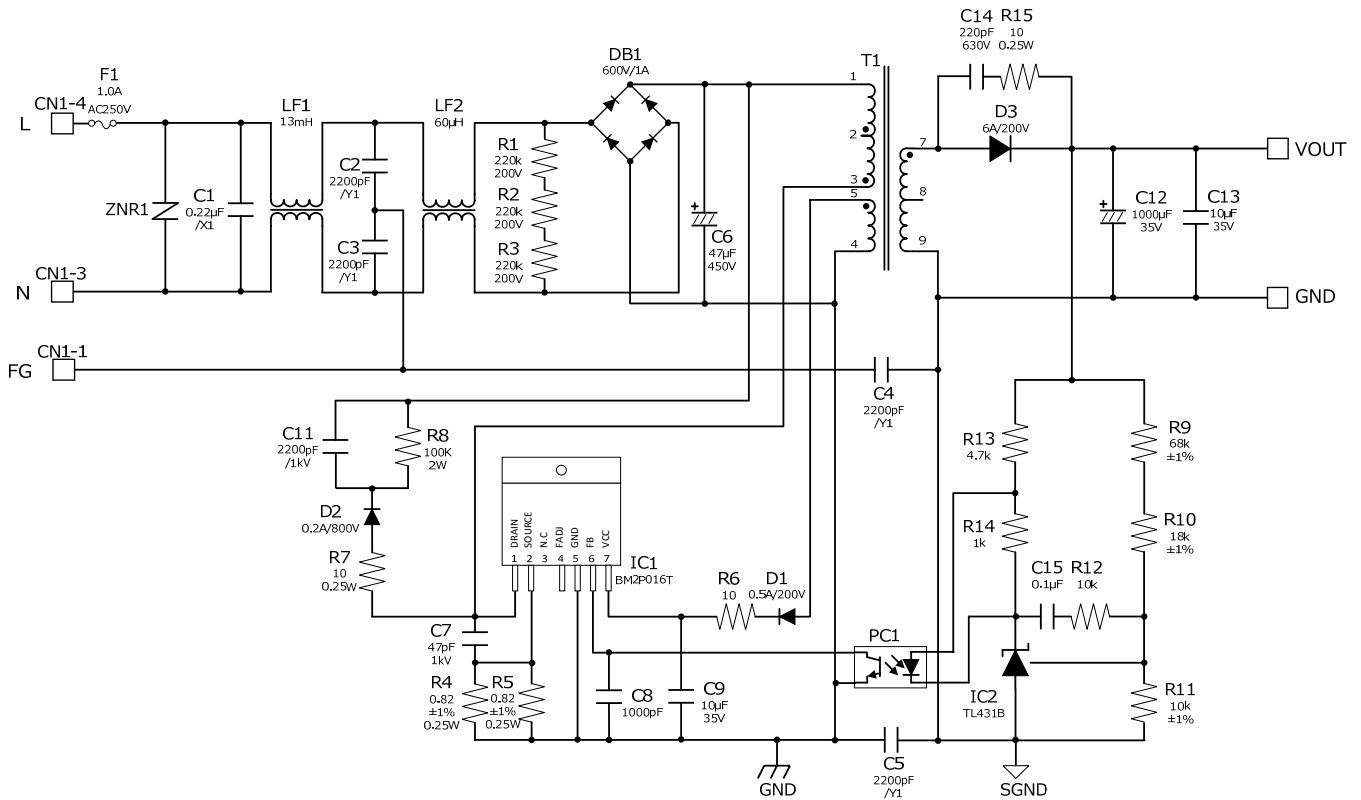

Figure 3. BM2P016T-EVK-001 Schematics

Bill of Materials

Table 1. BoM of BM2P016T-EVK-001

Part Reference	Qty.	Type	Value	Description	Part Number	Manufacture	Configuration mm (inch)
C1	1	Film	0.22 μ F	275Vac, \pm 10%	LE224	OKAYA	-
C2,C3,C4,C5	4	Ceramic	2200pF	300Vac, \pm 20%	DE1E3KX222MB4BP01F	Murata	-
C6	1	Electrolytic	47 μ F	450V, \pm 20%	450LLE47MEFC18x25	Rubycon	-
C7	1	Ceramic	47pF	1000V, X7R, \pm 10%	RDER73A470J2K1H03B	Murata	-
C8	1	Ceramic	1000pF	100V, X7R, \pm 20%	HMK107B7102MA-T	Taiyo Yuden	1608 (0603)
C9	1	Ceramic	10 μ F	35V, X7R, \pm 20%	GMK316AB7106ML-TR	Taiyo Yuden	3216 (1206)
C11	1	Ceramic	2200pF	1000V, X7R, \pm 10%	RDER73A222K2K1H03B	Murata	-
C12	1	Electrolytic	1000 μ F	35V, \pm 20%	UPA1V102MPD	Nichicon	-
C13	1	Ceramic	10 μ F	35V X7R, \pm 20%	GMK316AB7106ML-TR	Taiyo Yuden	3216 (1206)
C14	1	Ceramic	220pF	630V COG, \pm 5%	GRM31A5C2J221J	Murata	3216 (1206)
C15	1	Ceramic	0.1 μ F	100V, X7R, \pm 20%	HMK107B7104MA-T	Taiyo Yuden	1608 (0603)
ZNR1	1	Varistor	-	470V, 400A	V470ZA05P	Littelfuse	-
F1	1	Fuse	1A	250V	39211000000	Littelfuse	-
LF1	1	Line Filter	13mH	1A	FT20-087	Alpha Trans	-
LF2	1	Line Filter	60 μ H	1A	LF1246Y	Alpha Trans	-
T1	1	Transformer	-	Bobin:EI-2506, Core:EE25/20	XE2096	Alpha Trans	-
PC1	1	Optocoupler	-	5kV	PC817	SHARP	-
IC1	1	AC/DC Converter	-	-	BM2P016T-Z	ROHM	DIP7
IC2	1	Shunt Regulator	-	\pm 0.5%	TL431BIDBZT	TI	SOT-23-3
DB1	1	Bridge	1A	600V	S1NB60-7062	Shindengen	-
D1	1	FRD	0.5A	200V	RF05VAM2S	ROHM	TUMD2M
D2	1	FRD	0.2A	800V	RFU02VSM8S	ROHM	TUMD2SM
D3	1	FRD	6A	200V	RFN6BM2D	ROHM	TO-252
R1,R2,R3	3	Resistor	220k Ω	0.25W, 200V, \pm 5%	MCR18EZPJ224	ROHM	3216 (1206)
R4,R5	2	Resistor	0.82 Ω	0.25W, \pm 1%	MCR18EZHFLR820	ROHM	3216 (1206)
R6,R7,R15	3	Resistor	10 Ω	0.25W, \pm 5%	MCR18EZPJ100	ROHM	3216 (1206)
R8	1	Resistor	100k Ω	2W, 700V, \pm 2%	ERG2S104E	Panasonic	-
R9	1	Resistor	68k Ω	0.1W, \pm 1%	MCR03EZPFX6802	ROHM	1608 (0603)
R10	1	Resistor	18k Ω	0.1W, \pm 1%	MCR03EZPFX1802	ROHM	1608 (0603)
R11	1	Resistor	10k Ω	0.1W, \pm 1%	MCR03EZPFX1002	ROHM	1608 (0603)
R12	1	Resistor	10k Ω	0.1W, \pm 5%	MCR03EZPJ103	ROHM	1608 (0603)
R13	1	Resistor	4.7k Ω	0.1W, \pm 5%	MCR03EZPJ472	ROHM	1608 (0603)
R14	1	Resistor	1k Ω	0.1W, \pm 5%	MCR03EZPJ102	ROHM	1608 (0603)

PCB

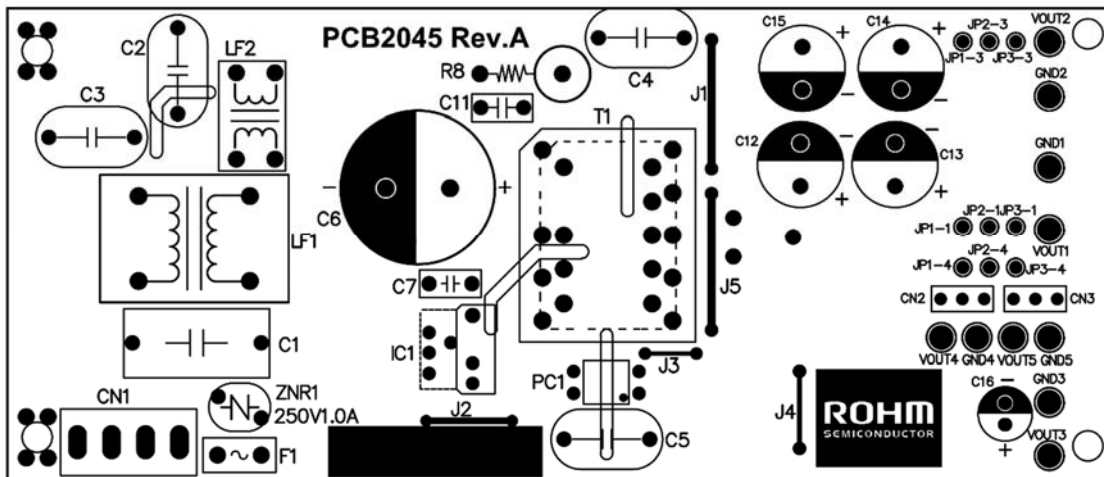

Figure 4. Top Silkscreen (Top view)

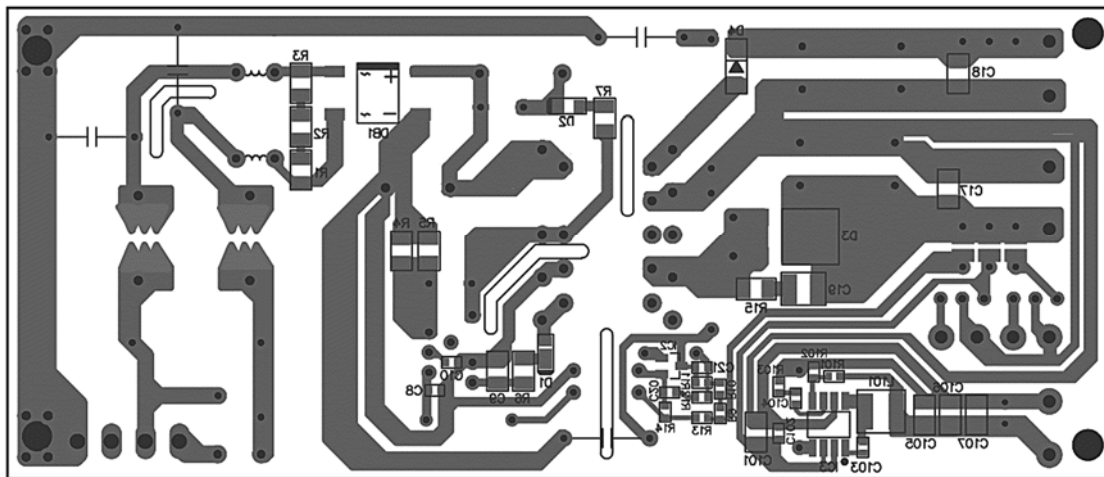

Figure 5. Bottom Layout (Top view)

Transformer Design

Product : XE2145A AlphaTrans Corp.

Bobin : EI-2506 10PIN

Core : EE25/20 JSF

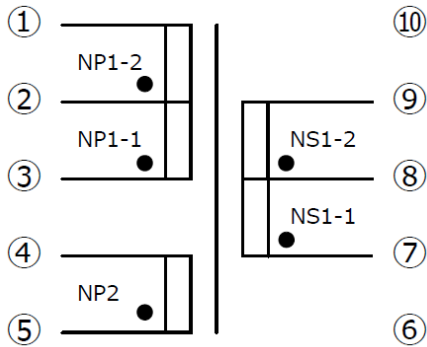

Figure 6. Connection Diagram

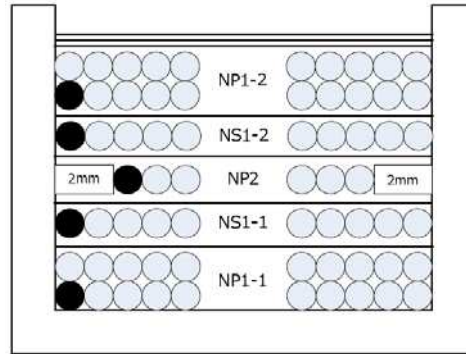

Figure 7. Winding structure diagram

Table 2. Winding Specification

Winding	PIN	Winding Material	Number of Turns		
			Winding*	Barrier Tape	Insulation Tape
NP1-1	③→②	2UEW 0.30	56T / 2Layer		1T
NS1-1	⑦→⑧	TEX-E 0.50	14T	2mm	1T
NP2	⑤→④	2UEW 0.30	18T		1T
NS1-2	⑧→⑨	TEX-E 0.50	14T		1T
NP1-2	②→①	2UEW 0.30	54T / 2Layer		3T

*All windings are closely wound

Inductance (Lp)	1350μH±10% (100kHz,1V)	
Leakage Inductance	60μH MAX	
Withstand Voltage	Pri - Sec	AC1500V
	Sec - Core	AC1500V
	Pri - Core	AC500V
Insulation resistance	100MΩ over (DC500V)	

Performance Data

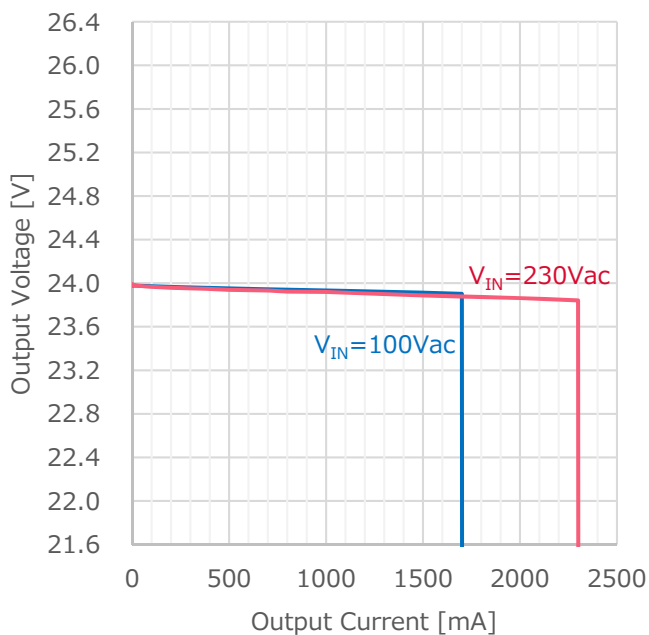

Figure 8. Load Regulation (I_{OUT} vs. V_{OUT})

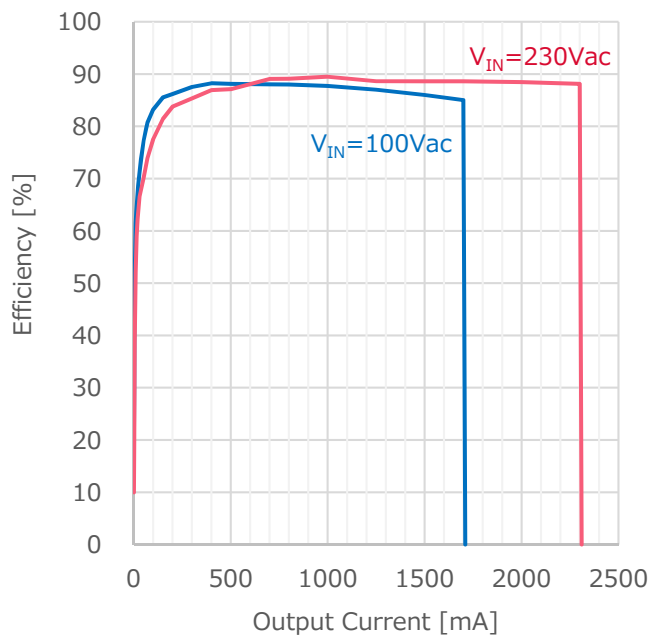

Figure 9. LOAD Regulation (I_{OUT} vs. Efficiency)

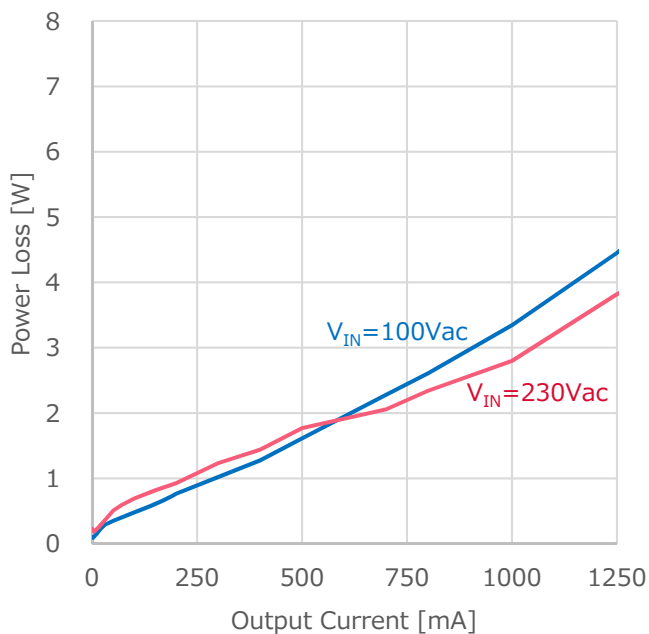

Figure 10. Load Regulation (I_{OUT} vs. P_{LOSS})

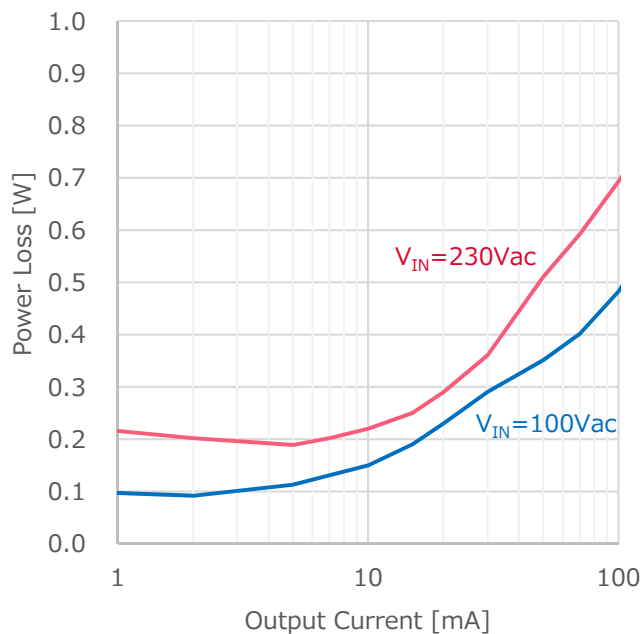

Figure 11. LOAD Regulation (I_{OUT} vs. P_{LOSS})

Table 3. Load Regulation ($V_{IN}=100Vac$)

I_{OUT}	V_{OUT}	Efficiency
250mA	23.955 V	84.52 %
500mA	23.952 V	88.12 %
750mA	23.941 V	88.02 %
1000mA	23.933 V	87.73 %

Table 4. Load Regulation ($V_{IN}=230Vac$)

I_{OUT}	V_{OUT}	Efficiency
250mA	23.955 V	84.65 %
500 mA	23.938 V	87.10 %
750 mA	23.928 V	89.06 %
1000 mA	23.920 V	89.49 %

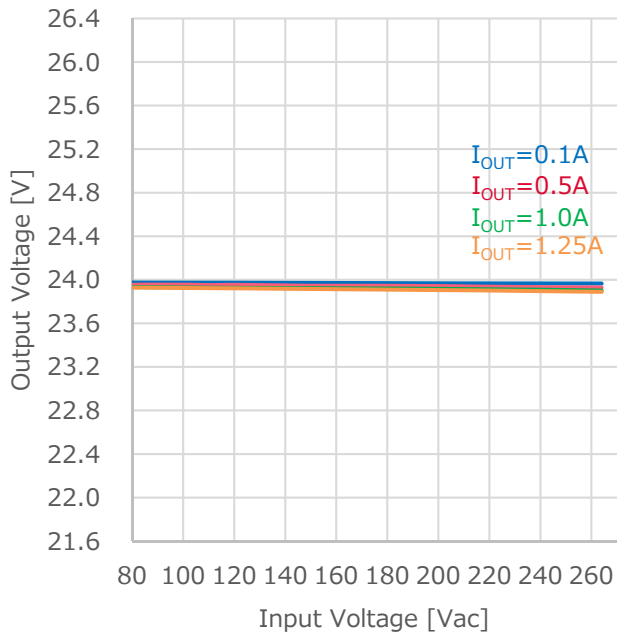

Figure 12. LINE Regulation (I_{OUT} vs. V_{OUT})

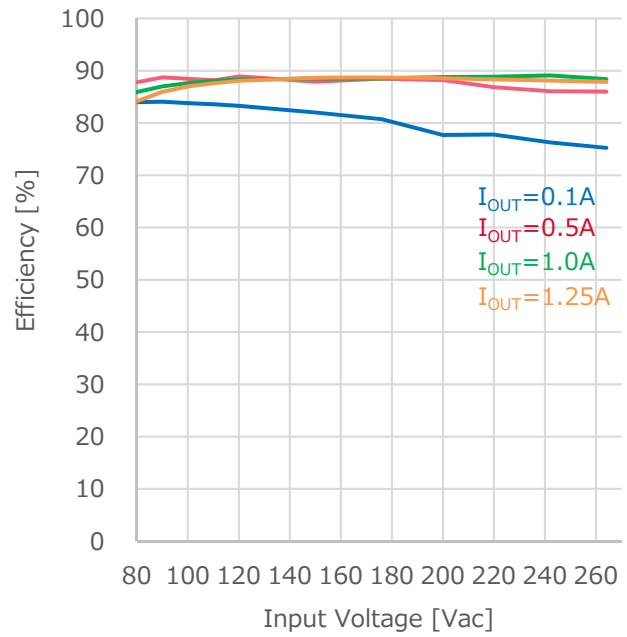

Figure 13. LINE Regulation (I_{OUT} vs. Efficiency)

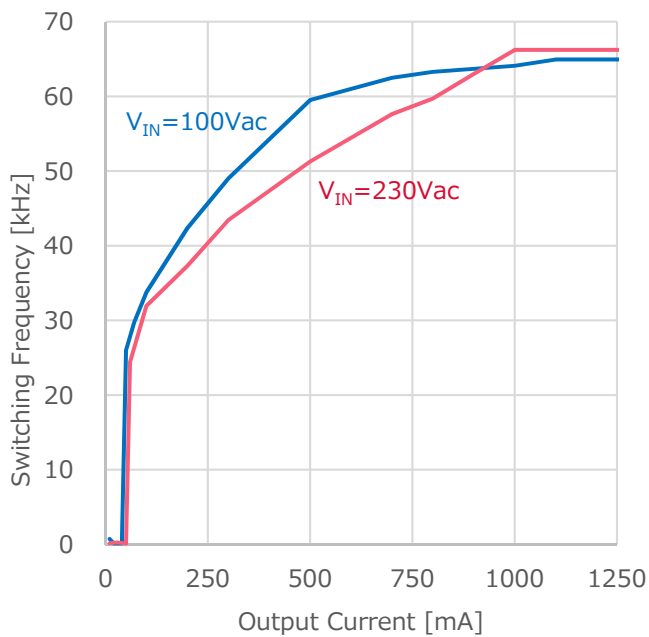

Figure 14. Switching Frequency (I_{OUT} vs. F_{sw})

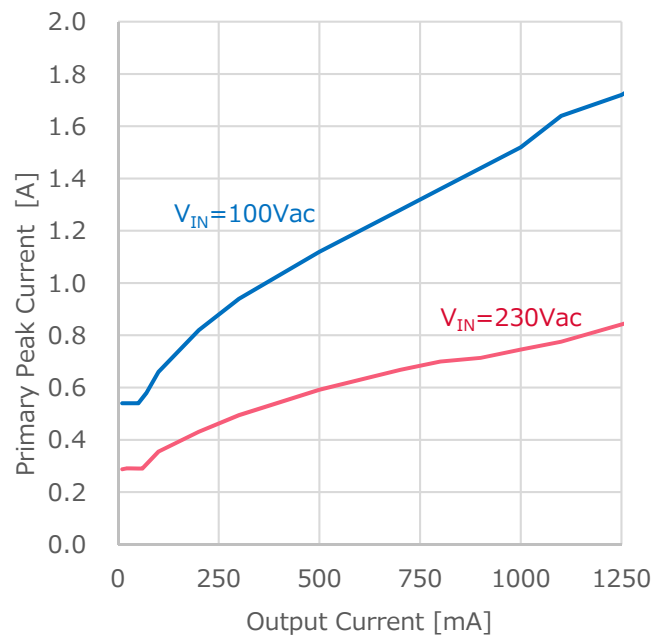

Figure 15. Primary Peak Current (I_{OUT} vs. I_{peak})

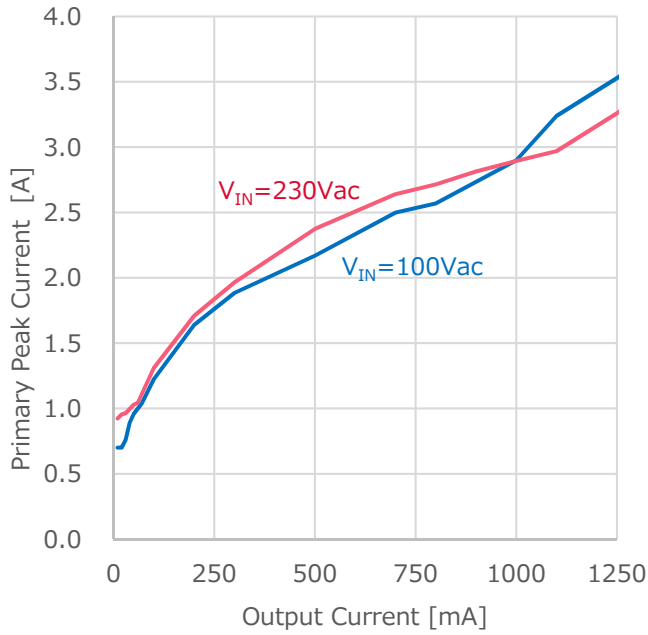

Figure 16. Secondary Peak Current (I_{OUT} vs. I_{peak})

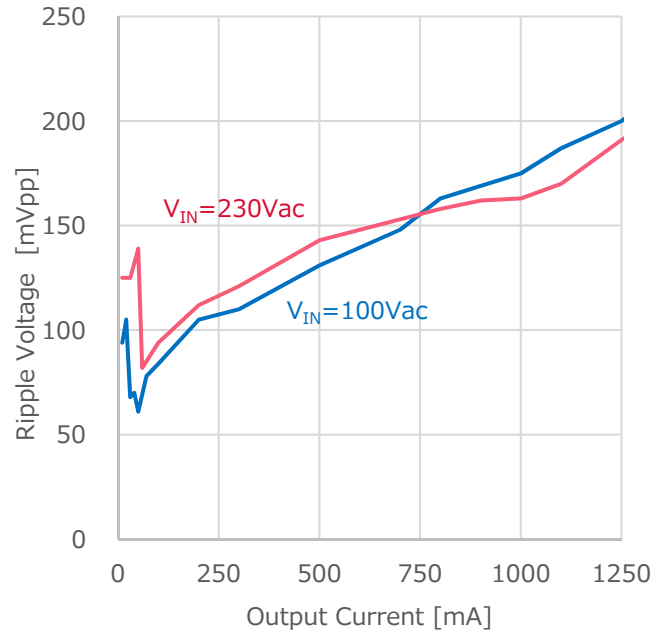
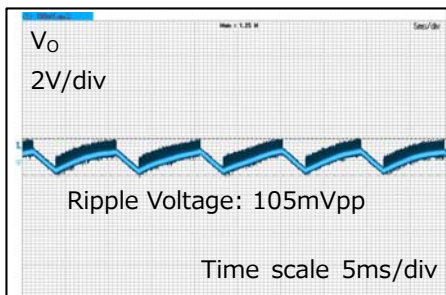
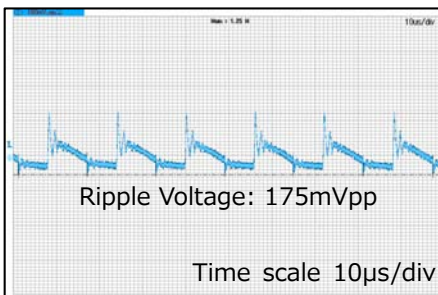

Figure 17. V_{OUT} Ripple Voltage (I_{OUT} vs. V_{ripple})



$V_{IN}=100Vac, I_{OUT}=20mA$

Figure 18. V_{OUT} Ripple Voltage.1



$V_{IN}=100Vac, I_{OUT}=1.0A$

Figure 19. V_{OUT} Ripple Voltage.2

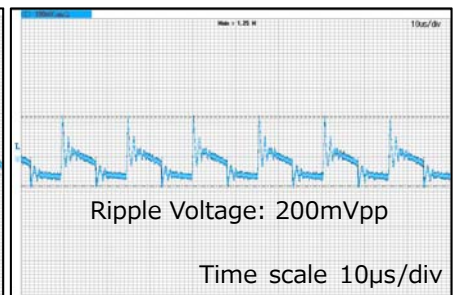

$V_{IN}=100Vac, I_{OUT}=1.25A$

Figure 20. V_{OUT} Ripple Voltage.3

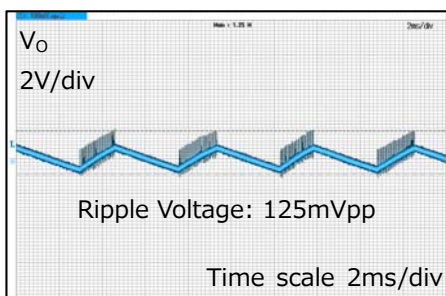

$V_{IN}=230Vac, I_{OUT}=20mA$

Figure 21. V_{OUT} Ripple Voltage.4

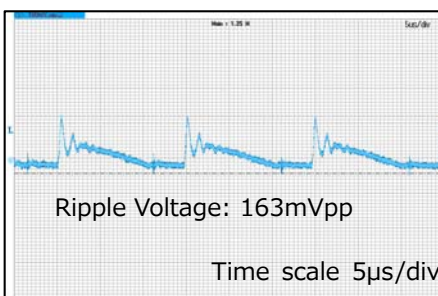

$V_{IN}=230Vac, I_{OUT}=1.0A$

Figure 22. V_{OUT} Ripple Voltage.5

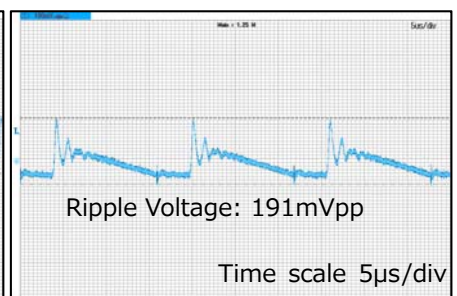

$V_{IN}=230Vac, I_{OUT}=1.25A$

Figure 23. V_{OUT} Ripple Voltage.6

Table 5. Parts surface temperature ※Ta:25°C, measured 30minutes after startup

Part	Condition			
	V _{IN} =100Vac, I _{OUT} =1.0A	V _{IN} =100Vac, I _{OUT} =1.25A	V _{IN} =230Vac, I _{OUT} =1.0A	V _{IN} =230Vac, I _{OUT} =1.25A
IC1	59.5°C	66.4°C	58.5°C	78.5°C
T1	64.8°C	66.4°C	54.7°C	63.4°C
R8	56.3°C	68.2°C	55.3°C	61.5°C
D3	60.4°C	64.7°C	56.6°C	62.9°C
IC1	59.5°C	66.4°C	58.3°C	78.6°C

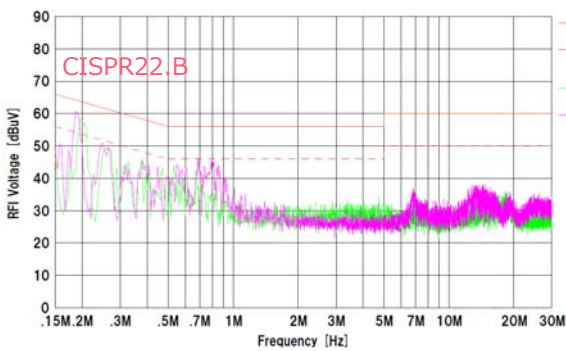

V_{IN}=100Vac/60Hz, I_{OUT}=1.25A

QP margin=13.1dB, AV margin=17.2dB

Figure 24. Conducted Emission.1

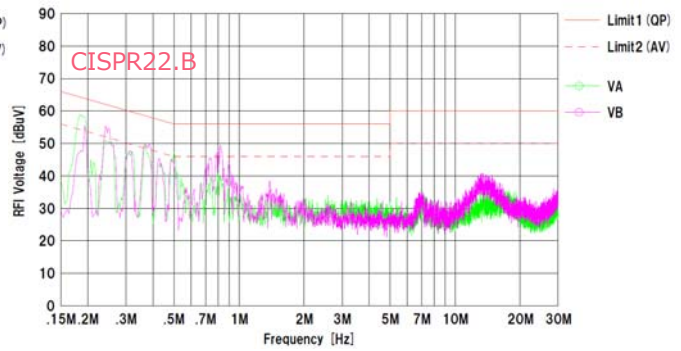

V_{IN}=230Vac/50Hz, I_{OUT}=1.25A

QP margin= 9.9dB, AV margin=13.4dB

Figure 25. Conducted Emission.2

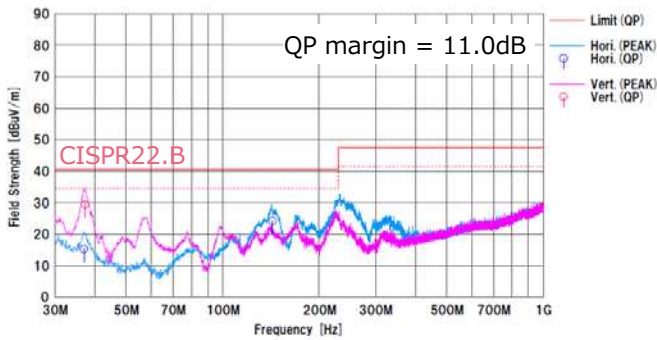

V_{IN}=100Vac/60Hz, I_{OUT}=1.25A

QP margin=11.0dB, AV margin=16.1dB

Figure 26. Radiated Emission.1

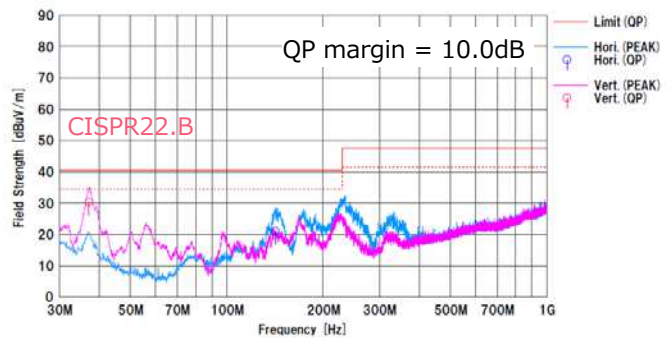

V_{IN}=230Vac/50Hz, I_{OUT}=1.25A

QP margin= 10.0dB, AV margin=15.3dB

Figure 27. Radiated Emission.2

Notes

- 1) The information contained herein is subject to change without notice.
- 2) Before you use our Products, please contact our sales representative and verify the latest specifications :
- 3) Although ROHM is continuously working to improve product reliability and quality, semiconductors can break down and malfunction due to various factors.
Therefore, in order to prevent personal injury or fire arising from failure, please take safety measures such as complying with the derating characteristics, implementing redundant and fire prevention designs, and utilizing backups and fail-safe procedures. ROHM shall have no responsibility for any damages arising out of the use of our Products beyond the rating specified by ROHM.
- 4) Examples of application circuits, circuit constants and any other information contained herein are provided only to illustrate the standard usage and operations of the Products. The peripheral conditions must be taken into account when designing circuits for mass production.
- 5) The technical information specified herein is intended only to show the typical functions of and examples of application circuits for the Products. ROHM does not grant you, explicitly or implicitly, any license to use or exercise intellectual property or other rights held by ROHM or any other parties. ROHM shall have no responsibility whatsoever for any dispute arising out of the use of such technical information.
- 6) The Products specified in this document are not designed to be radiation tolerant.
- 7) For use of our Products in applications requiring a high degree of reliability (as exemplified below), please contact and consult with a ROHM representative : transportation equipment (i.e. cars, ships, trains), primary communication equipment, traffic lights, fire/crime prevention, safety equipment, medical systems, servers, solar cells, and power transmission systems.
- 8) Do not use our Products in applications requiring extremely high reliability, such as aerospace equipment, nuclear power control systems, and submarine repeaters.
- 9) ROHM shall have no responsibility for any damages or injury arising from non-compliance with the recommended usage conditions and specifications contained herein.
- 10) ROHM has used reasonable care to ensure the accuracy of the information contained in this document. However, ROHM does not warrants that such information is error-free, and ROHM shall have no responsibility for any damages arising from any inaccuracy or misprint of such information.
- 11) Please use the Products in accordance with any applicable environmental laws and regulations, such as the RoHS Directive. For more details, including RoHS compatibility, please contact a ROHM sales office. ROHM shall have no responsibility for any damages or losses resulting non-compliance with any applicable laws or regulations.
- 12) When providing our Products and technologies contained in this document to other countries, you must abide by the procedures and provisions stipulated in all applicable export laws and regulations, including without limitation the US Export Administration Regulations and the Foreign Exchange and Foreign Trade Act.
- 13) This document, in part or in whole, may not be reprinted or reproduced without prior consent of ROHM.



Thank you for your accessing to ROHM product informations.
More detail product informations and catalogs are available, please contact us.

ROHM Customer Support System

<http://www.rohm.com/contact/>

■<High Voltage Safety Precautions>

◇ Read all safety precautions before use

Please note that this document covers only the BM2P016T evaluation board (BM2P016T-EVK-001) and its functions. For additional information, please refer to the datasheet.

To ensure safe operation, please carefully read all precautions before handling the evaluation board

Depending on the configuration of the board and voltages used,



Potentially lethal voltages may be generated.

Therefore, please make sure to read and observe all safety precautions described in the red box below.

Before Use

- [1] Verify that the parts/components are not damaged or missing (i.e. due to the drops).
- [2] Check that there are no conductive foreign objects on the board.
- [3] Be careful when performing soldering on the module and/or evaluation board to ensure that solder splash does not occur.
- [4] Check that there is no condensation or water droplets on the circuit board.

During Use

- [5] Be careful to not allow conductive objects to come into contact with the board.
- [6] **Brief accidental contact or even bringing your hand close to the board may result in discharge and lead to severe injury or death.**
Therefore, DO NOT touch the board with your bare hands or bring them too close to the board.
In addition, as mentioned above please exercise extreme caution when using conductive tools such as tweezers and screwdrivers.
- [7] If used under conditions beyond its rated voltage, it may cause defects such as short-circuit or, depending on the circumstances, explosion or other permanent damages.
- [8] Be sure to wear insulated gloves when handling is required during operation.

After Use

- [9] The ROHM Evaluation Board contains the circuits which store the high voltage. Since it stores the charges even after the connected power circuits are cut, please discharge the electricity after using it, and please deal with it after confirming such electric discharge.
- [10] Protect against electric shocks by wearing insulated gloves when handling.

This evaluation board is intended for use only in research and development facilities and should be handled **only by qualified personnel familiar with all safety and operating procedures.**

We recommend carrying out operation in a safe environment that includes the use of high voltage signage at all entrances, safety interlocks, and protective glasses.