



Chipsmall Limited consists of a professional team with an average of over 10 year of expertise in the distribution of electronic components. Based in Hongkong, we have already established firm and mutual-benefit business relationships with customers from,Europe,America and south Asia,supplying obsolete and hard-to-find components to meet their specific needs.

With the principle of “Quality Parts,Customers Priority,Honest Operation,and Considerate Service”,our business mainly focus on the distribution of electronic components. Line cards we deal with include Microchip,ALPS,ROHM,Xilinx,Pulse,ON,Everlight and Freescale. Main products comprise IC,Modules,Potentiometer,IC Socket,Relay,Connector.Our parts cover such applications as commercial,industrial, and automotives areas.

We are looking forward to setting up business relationship with you and hope to provide you with the best service and solution. Let us make a better world for our industry!



Contact us

Tel: +86-755-8981 8866 Fax: +86-755-8427 6832

Email & Skype: info@chipsmall.com Web: www.chipsmall.com

Address: A1208, Overseas Decoration Building, #122 Zhenhua RD., Futian, Shenzhen, China



AC/DC Converter

Non-Isolation Buck Converter PWM method Output 2W -12V

BM2P129TF Reference Board

BM2P129TF-EVK-002

The BM2P129TF-EVK-002 evaluation board outputs -12V minus voltage from the input of 90Vac to 264Vac. The output current supplies up to 0.167A. BM2P109TF which is PWM method DC/DC converter IC built-in 650V MOSFET is used.

The BM2P129TF contributes to low power consumption by built-in a 650 V starting circuit. Built-in current detection resistor realizes compact power supply design.

Current mode control imposes current limitation on every cycle, providing superior performance in bandwidth and transient response. The switching frequency is 100 kHz in fixed mode. At light load, frequency is reduced and high efficiency is realized. Built-in frequency hopping function contributes to low EMI. Low on-resistance 9.5 Ω 650 V MOSFET built-in contributes to low power consumption and easy design.

The flywheel diode is a fast recovery diode of 1A/650 V RFN1LAM6S, contributing to low power consumption.

Electronics Characteristics

Not guarantee the characteristics, is representative value.

Unless otherwise noted : $V_{IN} = 230Vac$, $I_{OUT} = 120mA$, $T_a:25^{\circ}C$

Parameter	Min	Typ	Max	Units	Conditions
Input Voltage Range	90	230	264	Vac	
Input Frequency	47	50/60	63	Hz	
Output Voltage	-13.2	-12.0	10.8	V	
Maximum Output Power	-	-	2.0	W	$I_{OUT} = 167mA$
Output Current Range (NOTE1)	2	120	167	mA	
Stand-by Power	-	44	-	mW	$I_{OUT} = 0A$
Efficiency	-	72.2	-	%	
Output Ripple Voltage (NOTE2)	-	29	-	mVpp	
Operating Temperature Range	-10	25	65	$^{\circ}C$	

(NOTE1) Please adjust operating time, within any parts surface temperature under 105 $^{\circ}C$

(NOTE2) Not include spike noise

Operation Procedure

1. Operation Equipment

- (1) AC Power supply 90Vac~264Vac, over 10W
- (2) Electronic Load capacity 0.167A
- (3) Multi meter

2. Connect method

- (1) AC power supply presetting range 90~264Vac, Output switch is off.
- (2) Load setting under 0.167A. Load switch is off.
- (3) AC power supply N terminal connect to the board AC (N) of CN1, and L terminal connect to AC(L).
- (4) Load + terminal connect to VOUT1, GND terminal connect to GND1 terminal
- (5) AC power meter connect between AC power supply and board.
- (6) Output test equipment connects to output terminal
- (7) AC power supply switch ON.
- (8) Check that output voltage is -12V.
- (9) Electronic load switch ON
- (10) Check output voltage drop by load connect wire resistance



Figure 1. Connection Circuit

Deleting

Maximum Output Power P_o of this reference board is 2W. The derating curve is shown on the right.

if ambient temperature is over 50°C, please adjust load continuous time by over 105°C of any parts surface temperature.

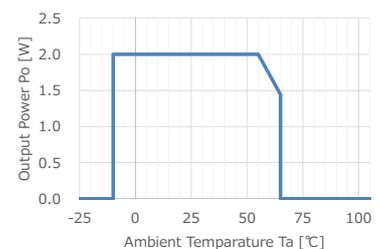

Figure 2. Temperature Derating curve

Schematics

$V_{IN} = 90\sim 264Vac$, $V_{OUT} = -12V$

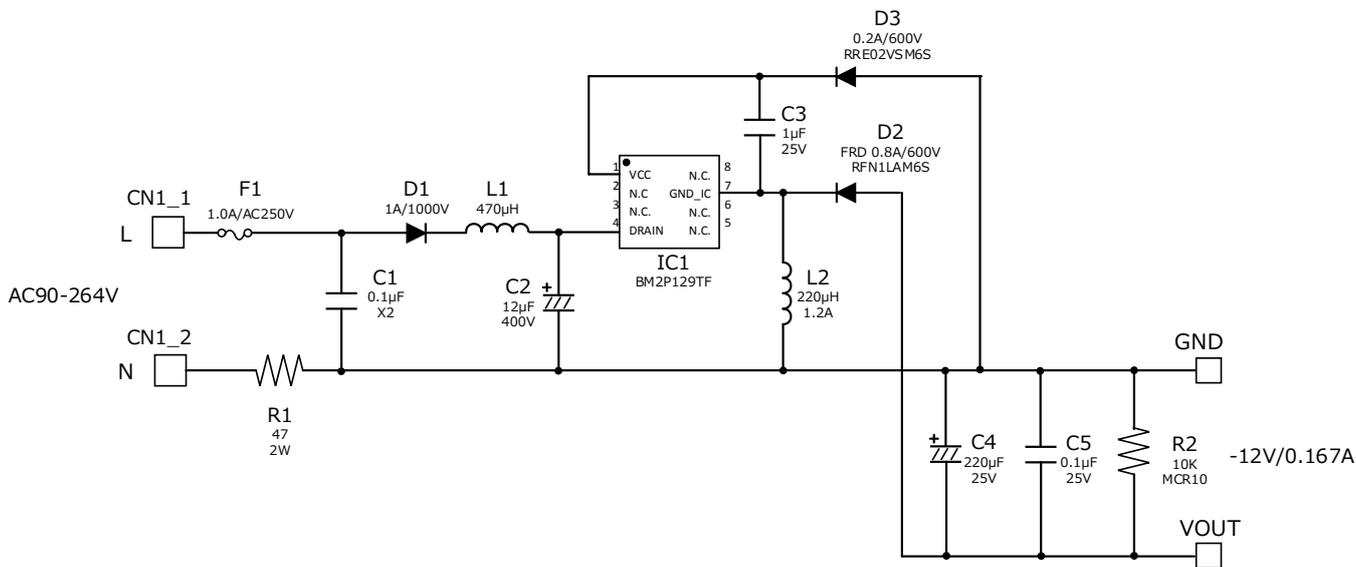

Figure 3. BM2P129TF-EVK-002 Schematics

Bill of Materials

Table 1. BoM of BM2P129TF-EVK-002

Part Reference	Qty.	Type	Value	Description	Part Number	Manufacture	Configuration mm (inch)
C1	1	Film	0.1μF X2		890 334 025 017 CS	Wurth	-
C2	1	Electrolytic	12μF 400V, ±20%		400BXW12MEFR10X16	Rubycon	-
C3	1	Ceramic	1uF 25V, X7R, ±20%		TMK107B7105MA-T	Taiyo Yuden	1608 (0603)
C4	1	Electrolytic	220uF 25VV, ±20%		860 080 474 010	Wurth	-
C5	1	Ceramic	0.1uF 50V, X7R, ±20%		HMK107B7104MA-T	Taiyo Yuden	1608 (0603)
CN1	1	Connector	-	2pin	B2P-VH	JST	-
D1	1	FRD	1A 1000V		1N4007-GP	Vishay	-
D2	1	FRD	0.8A 600V		RFN1LAM6S TR	ROHM	PMDS
D3	1	Diode	0.2A 600V		RRE02VSM6S	ROHM	TUMD2SM
F1	1	Fuse	1A 250V		39211000000	Littelfuse	-
IC1	1	AC/DC Converter	-	-	BM2P129TF	ROHM	SOP8
L1	1	Coil	470μH 0.25A		DRV060-471	Alphatrans	-
L2	1	Coil	220μH 1.2A		744 747 122 1	Wurth	-
R1	1	Resistor	47Ω 2W, ±5%		ERG-2SJ470	Panasonic	-
R2	1	Resistor	10kΩ 0.1W, ±5%		MCR10EZP103	ROHM	2012 (0805)

PCB

Size : 25 mm x 45 mm

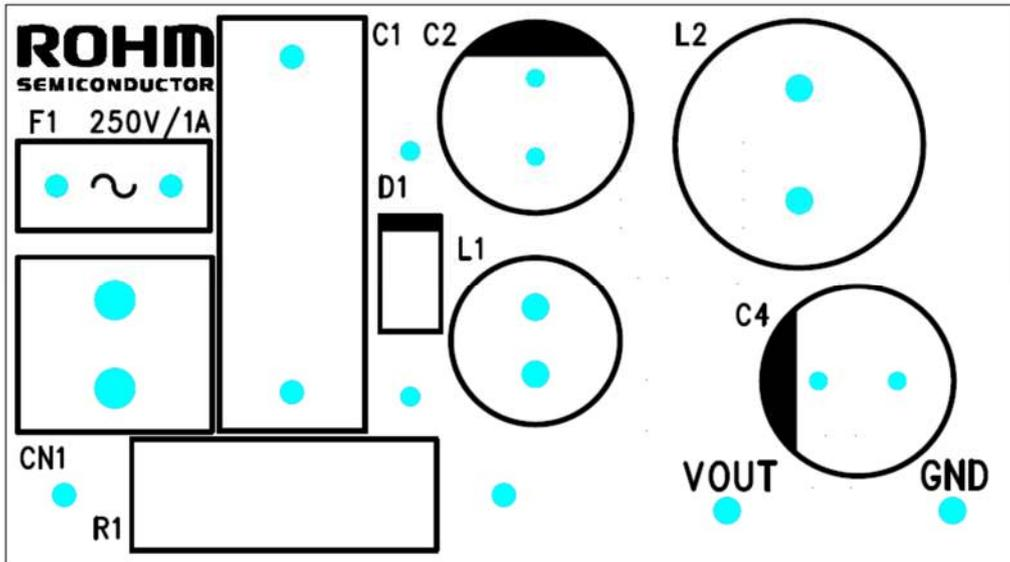

Figure 4. Top Silkscreen (Top view)

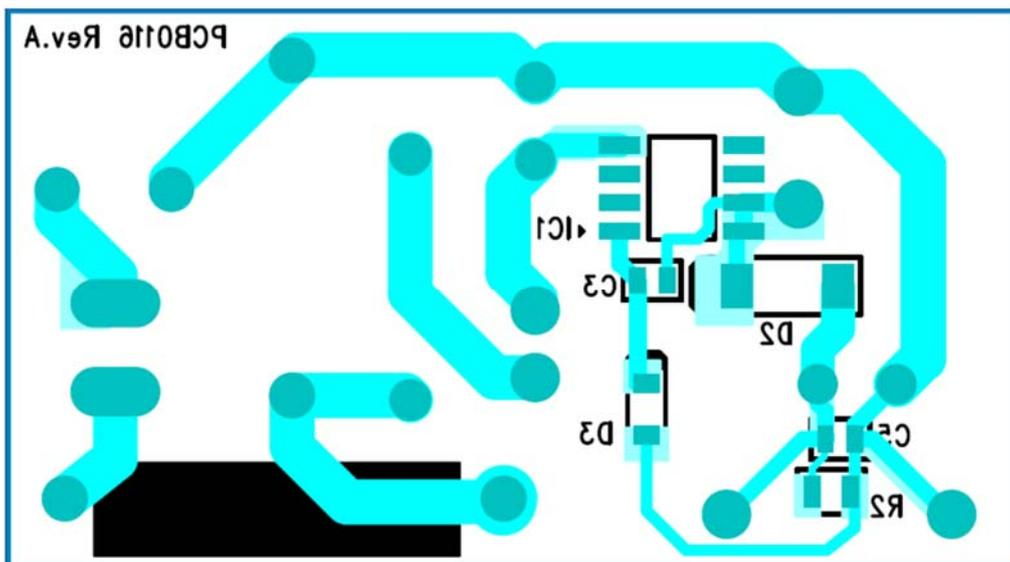

Figure 5. Bottom Layout (Top view)

Performance Data

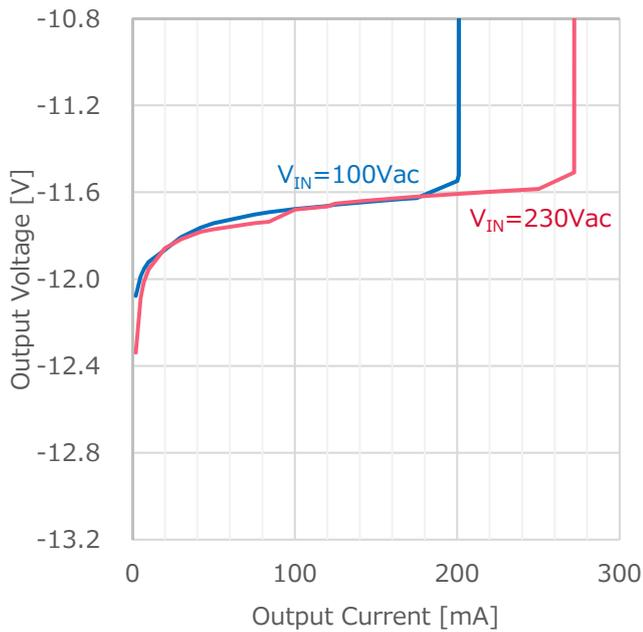

Figure 6. Load Regulation (I_{OUT} vs. V_{OUT})

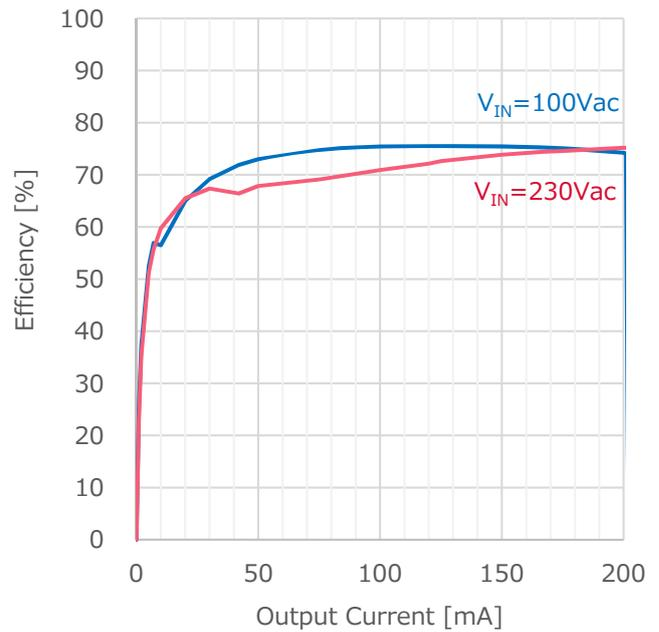

Figure 7. LOAD Regulation (I_{OUT} vs. Efficiency)

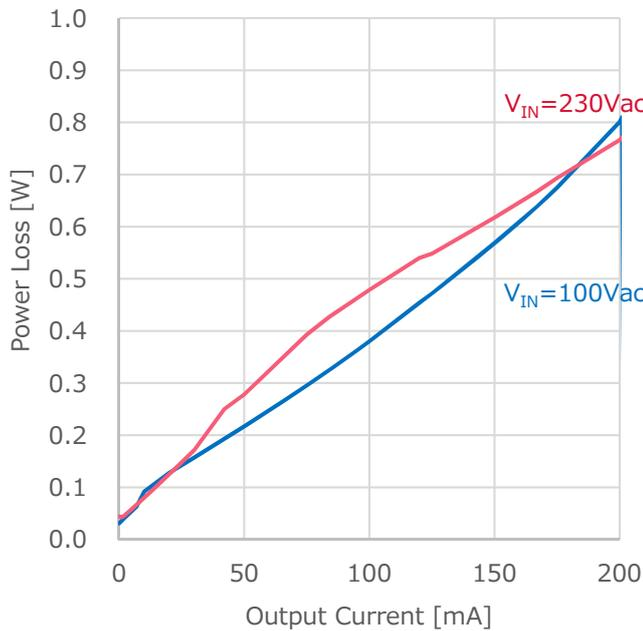

Figure 8. Load Regulation (I_{OUT} vs. P_{Loss})

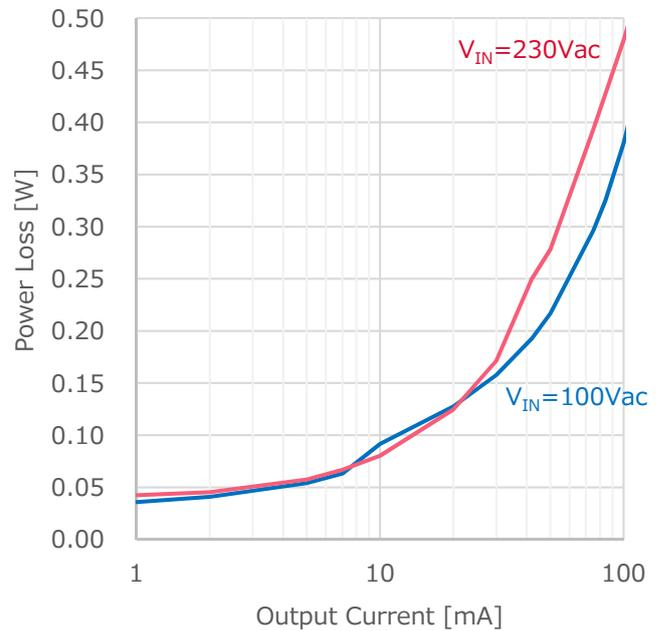

Figure 9. LOAD Regulation (I_{OUT} vs. P_{Loss})

Table 2. Load Regulation ($V_{IN}=100Vac$)

I_{OUT}	V_{OUT}	Efficiency
42 mA	-11.763 V	71.91 %
84 mA	-11.692 V	75.14 %
120 mA	-11.663 V	75.49 %
167 mA	-11.631 V	75.26 %

Table 3. Load Regulation ($V_{IN}=230Vac$)

I_{OUT}	V_{OUT}	Efficiency
42 mA	-11.782 V	66.42 %
84 mA	-11.736 V	69.77 %
120 mA	-11.665 V	72.15 %
167 mA	-11.625 V	74.41 %

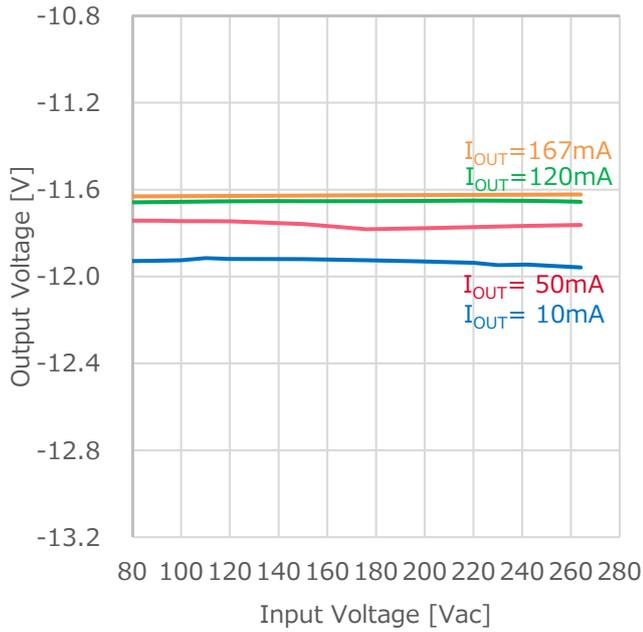

Figure 10. LINE Regulation (I_{OUT} vs. V_{OUT})

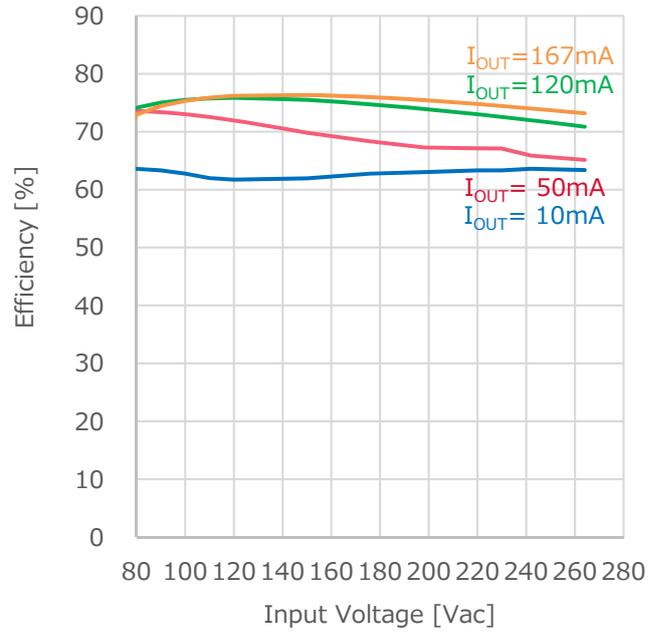

Figure 11. LINE Regulation (I_{OUT} vs. Efficiency)

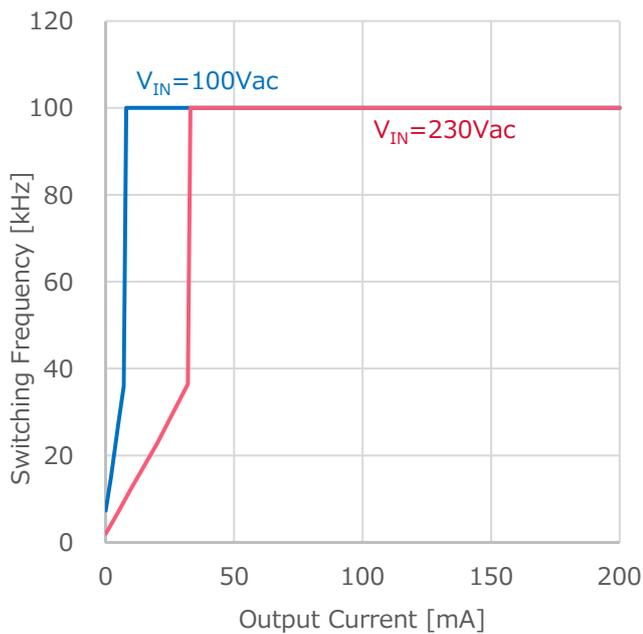

Figure 12. Switching Frequency (I_{OUT} vs. F_{SW})

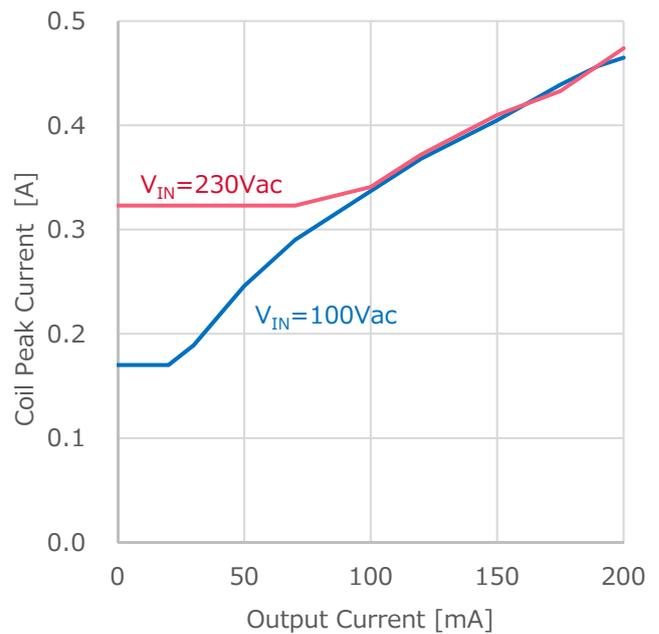

Figure 13. Coil Peak Current (I_{OUT} vs. I_{peak})

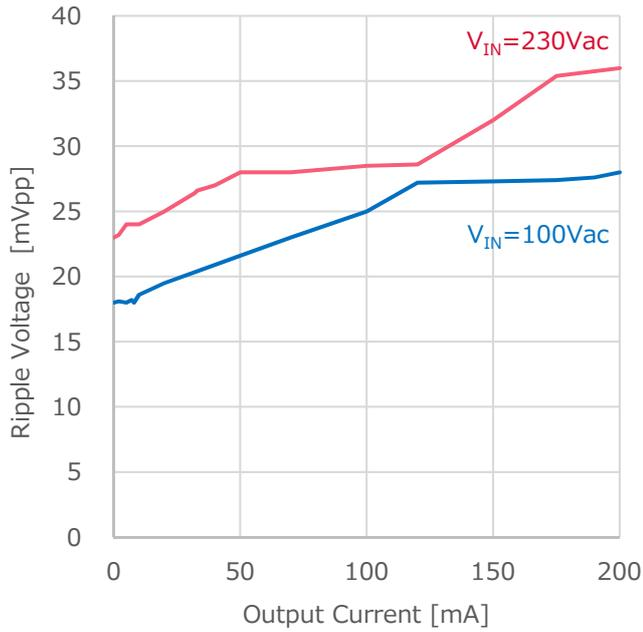
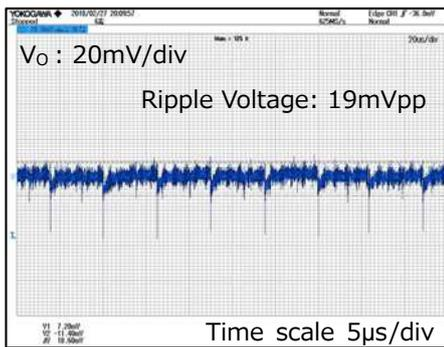
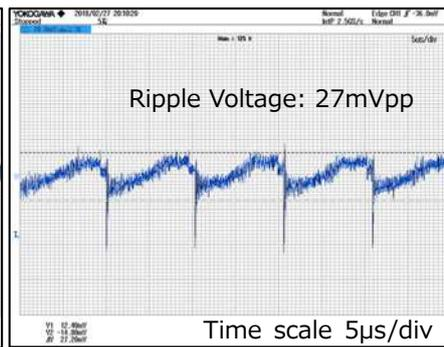

Figure 14. VOUT Ripple Voltage (I_{OUT} vs. V_{ripple})



$V_{IN}=100Vac, I_{OUT}=10mA$

Figure 15. VOUT Ripple Voltage.1



$V_{IN}=100Vac, I_{OUT}=120mA$

Figure 16. VOUT Ripple Voltage.2

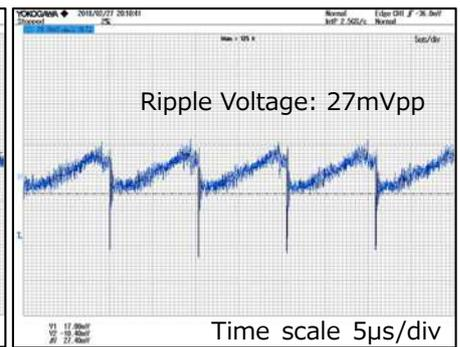

$V_{IN}=100Vac, I_{OUT}=167mA$

Figure 17. VOUT Ripple Voltage.3

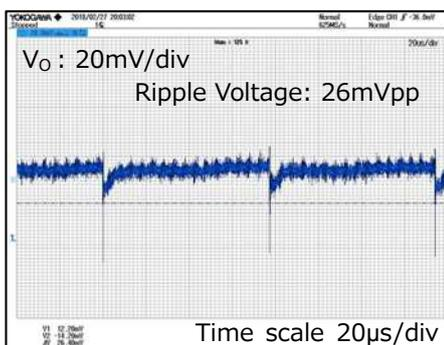

$V_{IN}=230Vac, I_{OUT}=10mA$

Figure 18. VOUT Ripple Voltage.4

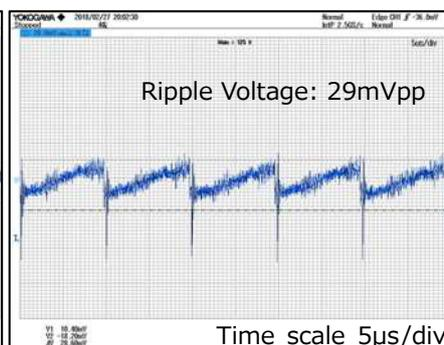

$V_{IN}=230Vac, I_{OUT}=120mA$

Figure 19. VOUT Ripple Voltage.5

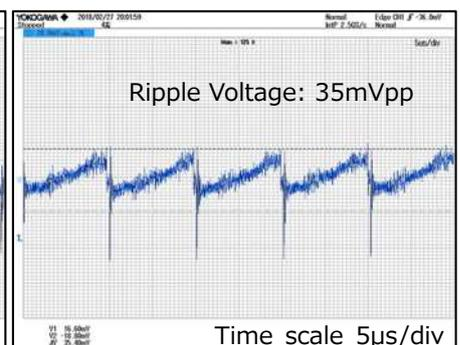

$V_{IN}=230Vac, I_{OUT}=167mA$

Figure 20. VOUT Ripple Voltage.6

Table 4. Parts surface temperature

※Ta:25°C, measured 30minutes after startup

Part	Condition			
	V _{IN} =90Vac, I _{OUT} =0.120A	V _{IN} =90Vac, I _{OUT} =0.167A	V _{IN} =264Vac, I _{OUT} =0.120A	V _{IN} =264Vac, I _{OUT} =0.167A
IC1	47.7°C	51.4°C	64.7°C	67.4°C
D1	51.2°C	46.6°C	56.2°C	59.6°C
L1	43.7°C	45.2°C	52.0°C	60.3°C

Notes

- 1) The information contained herein is subject to change without notice.
- 2) Before you use our Products, please contact our sales representative and verify the latest specifications :
- 3) Although ROHM is continuously working to improve product reliability and quality, semiconductors can break down and malfunction due to various factors.
Therefore, in order to prevent personal injury or fire arising from failure, please take safety measures such as complying with the derating characteristics, implementing redundant and fire prevention designs, and utilizing backups and fail-safe procedures. ROHM shall have no responsibility for any damages arising out of the use of our Products beyond the rating specified by ROHM.
- 4) Examples of application circuits, circuit constants and any other information contained herein are provided only to illustrate the standard usage and operations of the Products. The peripheral conditions must be taken into account when designing circuits for mass production.
- 5) The technical information specified herein is intended only to show the typical functions of and examples of application circuits for the Products. ROHM does not grant you, explicitly or implicitly, any license to use or exercise intellectual property or other rights held by ROHM or any other parties. ROHM shall have no responsibility whatsoever for any dispute arising out of the use of such technical information.
- 6) The Products specified in this document are not designed to be radiation tolerant.
- 7) For use of our Products in applications requiring a high degree of reliability (as exemplified below), please contact and consult with a ROHM representative : transportation equipment (i.e. cars, ships, trains), primary communication equipment, traffic lights, fire/crime prevention, safety equipment, medical systems, servers, solar cells, and power transmission systems.
- 8) Do not use our Products in applications requiring extremely high reliability, such as aerospace equipment, nuclear power control systems, and submarine repeaters.
- 9) ROHM shall have no responsibility for any damages or injury arising from non-compliance with the recommended usage conditions and specifications contained herein.
- 10) ROHM has used reasonable care to ensure the accuracy of the information contained in this document. However, ROHM does not warrants that such information is error-free, and ROHM shall have no responsibility for any damages arising from any inaccuracy or misprint of such information.
- 11) Please use the Products in accordance with any applicable environmental laws and regulations, such as the RoHS Directive. For more details, including RoHS compatibility, please contact a ROHM sales office. ROHM shall have no responsibility for any damages or losses resulting non-compliance with any applicable laws or regulations.
- 12) When providing our Products and technologies contained in this document to other countries, you must abide by the procedures and provisions stipulated in all applicable export laws and regulations, including without limitation the US Export Administration Regulations and the Foreign Exchange and Foreign Trade Act.
- 13) This document, in part or in whole, may not be reprinted or reproduced without prior consent of ROHM.



Thank you for your accessing to ROHM product informations.
More detail product informations and catalogs are available, please contact us.

ROHM Customer Support System

<http://www.rohm.com/contact/>

■<High Voltage Safety Precautions>

◇ Read all safety precautions before use

Please note that this document covers only the BM2P129TF evaluation board (BM2P129TF-EVK-002) and its functions. For additional information, please refer to the datasheet.

To ensure safe operation, please carefully read all precautions before handling the evaluation board

Depending on the configuration of the board and voltages used,



Potentially lethal voltages may be generated.

Therefore, please make sure to read and observe all safety precautions described in the red box below.

Before Use

- [1] Verify that the parts/components are not damaged or missing (i.e. due to the drops).
- [2] Check that there are no conductive foreign objects on the board.
- [3] Be careful when performing soldering on the module and/or evaluation board to ensure that solder splash does not occur.
- [4] Check that there is no condensation or water droplets on the circuit board.

During Use

- [5] Be careful to not allow conductive objects to come into contact with the board.
- [6] **Brief accidental contact or even bringing your hand close to the board may result in discharge and lead to severe injury or death.**
Therefore, DO NOT touch the board with your bare hands or bring them too close to the board.
In addition, as mentioned above please exercise extreme caution when using conductive tools such as tweezers and screwdrivers.
- [7] If used under conditions beyond its rated voltage, it may cause defects such as short-circuit or, depending on the circumstances, explosion or other permanent damages.
- [8] Be sure to wear insulated gloves when handling is required during operation.

After Use

- [9] The ROHM Evaluation Board contains the circuits which store the high voltage. Since it stores the charges even after the connected power circuits are cut, please discharge the electricity after using it, and please deal with it after confirming such electric discharge.
- [10] Protect against electric shocks by wearing insulated gloves when handling.

This evaluation board is intended for use only in research and development facilities and should be handled **only by qualified personnel familiar with all safety and operating procedures.**

We recommend carrying out operation in a safe environment that includes the use of high voltage signage at all entrances, safety interlocks, and protective glasses.