



Chipsmall Limited consists of a professional team with an average of over 10 year of expertise in the distribution of electronic components. Based in Hongkong, we have already established firm and mutual-benefit business relationships with customers from,Europe,America and south Asia,supplying obsolete and hard-to-find components to meet their specific needs.

With the principle of “Quality Parts,Customers Priority,Honest Operation,and Considerate Service”,our business mainly focus on the distribution of electronic components. Line cards we deal with include Microchip,ALPS,ROHM,Xilinx,Pulse,ON,Everlight and Freescale. Main products comprise IC,Modules,Potentiometer,IC Socket,Relay,Connector.Our parts cover such applications as commercial,industrial, and automotives areas.

We are looking forward to setting up business relationship with you and hope to provide you with the best service and solution. Let us make a better world for our industry!



Contact us

Tel: +86-755-8981 8866 Fax: +86-755-8427 6832

Email & Skype: info@chipsmall.com Web: www.chipsmall.com

Address: A1208, Overseas Decoration Building, #122 Zhenhua RD., Futian, Shenzhen, China



SPECIFICATION FOR APPROVAL

REF :

PAGE: 1

PROD. NAME	SMD BALUN TRANSFORMER	DWG NO.	BRN6036 Series
		ITEM NO.	

I . MECHANICAL DIMENSIONS :

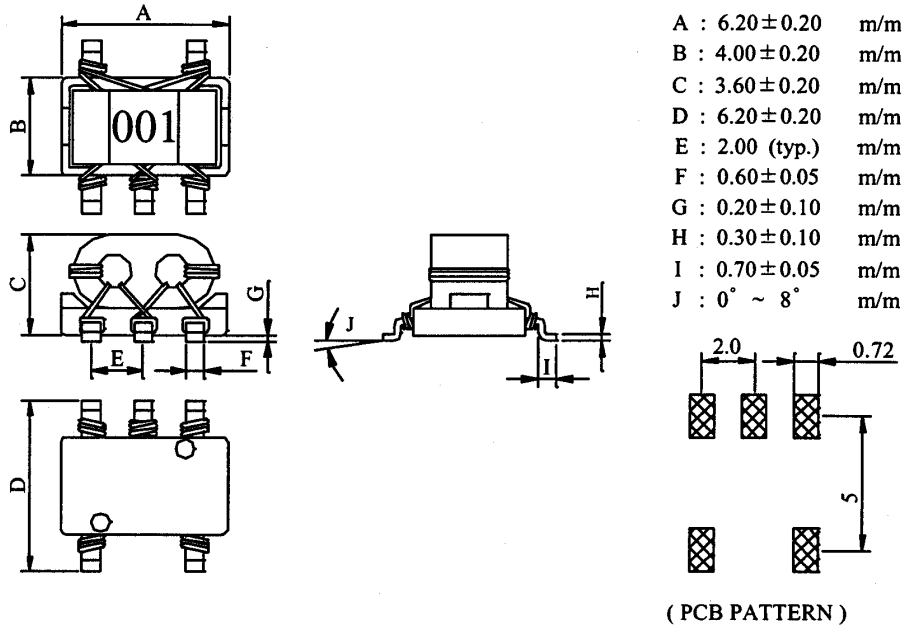

II . MATERIALS :

- a. CORE : FERRITE RID CORE
- b. BASE : PHENOLIC
- c. WIRE : ENAMELLED COPPER WIRE
- d. ADHESIVE : EPOXY RESIN
- e. TERMINAL : TINNED COPPER PLATE

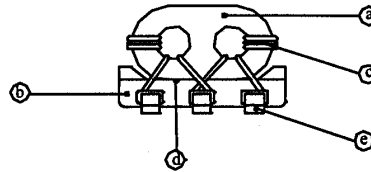

III . FEATURES :

- a. PAIRED WIRE COIL FOR HIGH STABILITY.
- b. BASE PIN TERMINAL TREATED, ALLOWING MOUNTING 'AS IS' ON A PCB.

IV . APPLICATIONS :

- a. DOUBLE BALANCE MIXERS, BROAD-BAND TRANSFORMERS, IMPEDANCE TRANSFORMERS, ETC.

AE-001A

Bourns Inductive Solution

SPECIFICATION FOR APPROVAL

REF :

PAGE: 2

PROD. NAME	SMD BALUN TRANSFORMER	DWG NO.	BRN6036 Series
		ITEM NO.	

V . ELECTRICAL CHARACTERISTICS :

DWG NO.	WINDING TURNS	OPERATING FREQUENCY RANGE	INSERTION LOSS	PIN CONNECTION FIG.
BRN6036-0001S	2.0	30.0MHz- 850MHz	3.0dB max.	1
BRN6036-0002S	3.0	5.0MHz-1000MHz	3.0dB max.	1
BRN6036-0003S	4.0	9.0MHz-1700MHz	3.0dB max.	1
BRN6036-0004S	5.0	5.5MHz-1500MHz	3.0dB max.	1
BRN6036-0005S	1.0	20.0MHz- 400MHz	3.0dB max.	2
BRN6036-0006S	2.0	8.0MHz- 550MHz	3.0dB max.	2
BRN6036-0007S	3.0	3.5MHz-500MHz	3.0dB max.	2
BRN6036-0008S	4.0	2.0MHz-370MHz	3.0dB max.	2
BRN6036-0009S	1.0	100.0MHz- 500MHz	3.0dB max.	2
BRN6036-0010S	2.0	500.0MHz-850MHz	3.0dB max.	2
BRN6036-0011S	3.0	240.0MHz-500MHz	3.0dB max.	2
BRN6036-0012S	4.0	85.0MHz-380MHz	3.0dB max.	2
BRN6036-0013S	1.5	5.5MHz-850MHz	3.0dB max.	3
BRN6036-0014S	2.5	2.5MHz-2000MHz	3.0dB max.	3
BRN6036-0015S	3.5	1.2MHz-1700MHz	3.0dB max.	3
BRN6036-0016S	4.5	0.8MHz-1400MHz	3.0dB max.	3
BRN6036-0017S	5.5	0.6MHz-1300MHz	3.0dB max.	3
BRN6036-0018S	1.5	160.0MHz-2200MHz	3.0dB max.	4
BRN6036-0019S	2.5	55.0MHz-1700MHz	3.0dB max.	4
BRN6036-0020S	3.5	30.0MHz-1400MHz	3.0dB max.	4

VI . SCHEMATIC DIAGRAM :

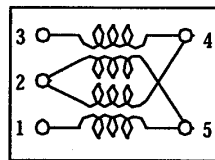

Double balanced
Fig.1

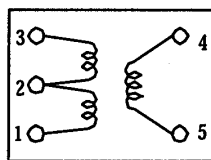

Transformer
Fig.2

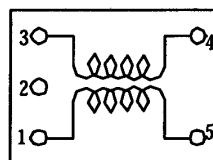

Transformer
Fig.3

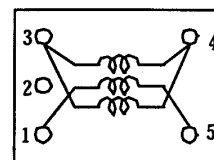

Transformer
Fig.4

AE-001A

Bourns Inductive Solution

SPECIFICATION FOR APPROVAL

REF :

PAGE: 3

PROD. NAME	SMD BALUN TRANSFORMER	DWG NO.	BRN6036 Series
		ITEM NO.	

VII . PACKAGING INFORMATION :

(1) CONFIGURATION

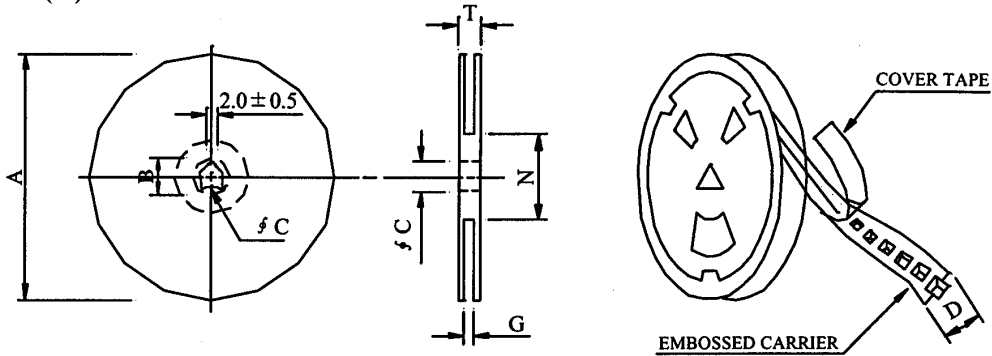

※CARRIER TAPE WIDTH : D

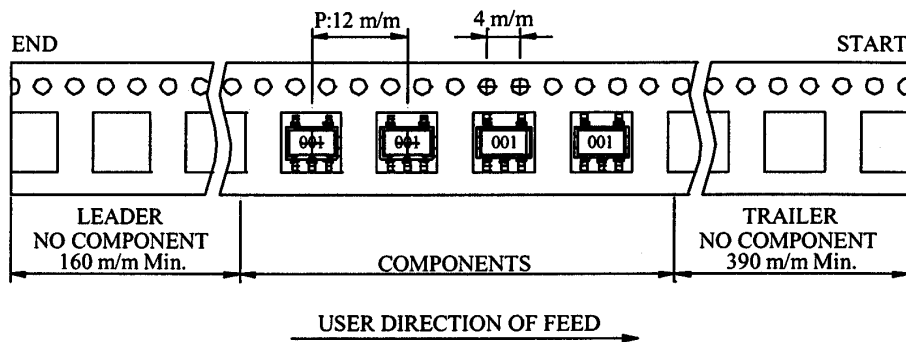

(2) DIMENSIONS

Unit:m/m

STYLE	A	B	C	D	G	N	T
07 - 16	178	21 ± 0.8	13	16	18 ⁺⁰	50 ⁻⁰	22.4
13 - 16	330	21 ± 0.8	13	16	18 ⁺⁰	50 ⁻⁰	22.4

(3) QTY & G.W. PER PACKAGE

SERIES	INNER : REEL			OUTER : CARTON		
	QTY (PCS)	G.W. (gw)	STYLE	QTY (PCS)	G.W. (Kg)	SIZE (cm)
BRN6036	300	96	07 - 16	12,000	4.45	39 x 38 x 21.5
BRN6036	1,200	384	13 - 16	9,600	3.68	40 x 40 x 24

AE-001A

Bourns Inductive Solution

SPECIFICATION FOR APPROVAL

REF :

PAGE: 4

PROD. NAME	SMD BALUN TRANSFORMER	DWG NO.	BRN6036 Series
		ITEM NO.	

X . INSERTION LOSS TEST CURVE :

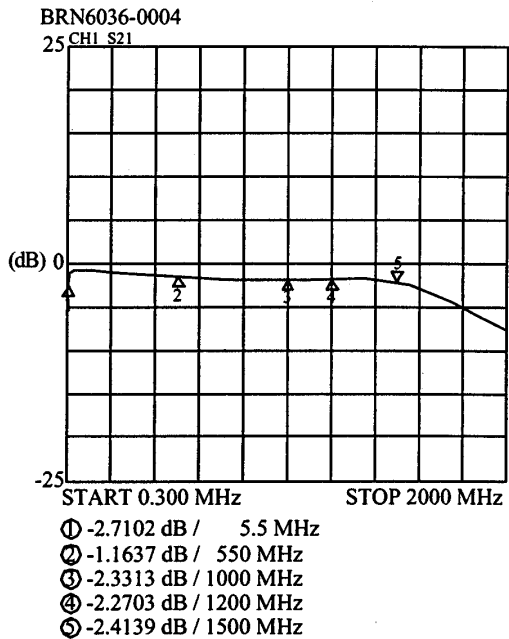
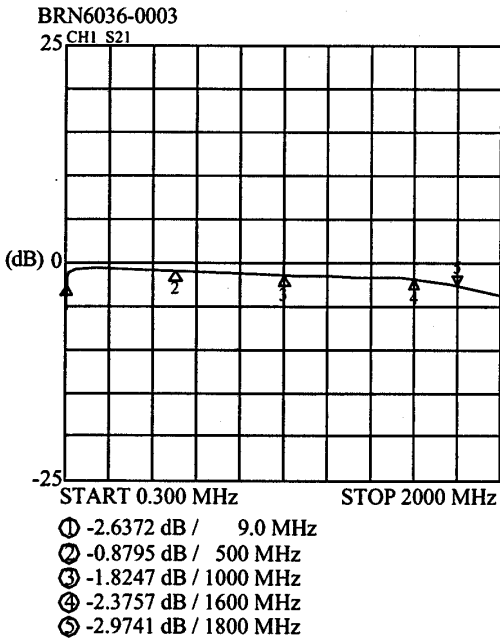
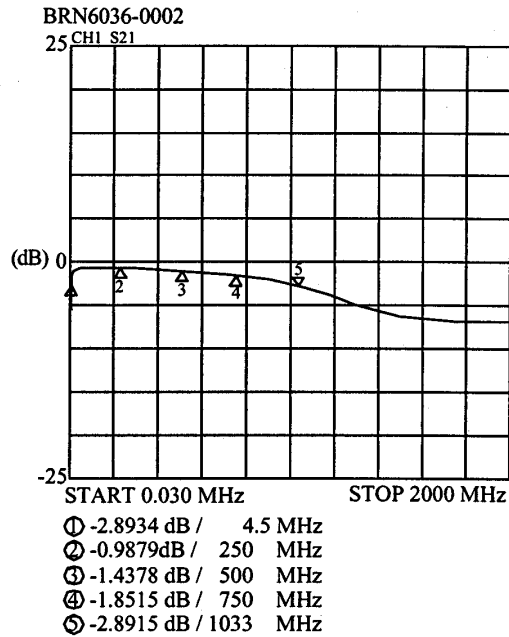
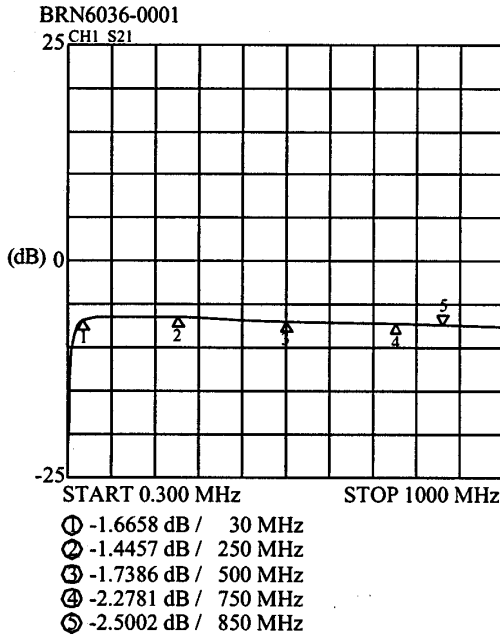

AE-001A

SPECIFICATION FOR APPROVAL

REF :

PAGE: 5

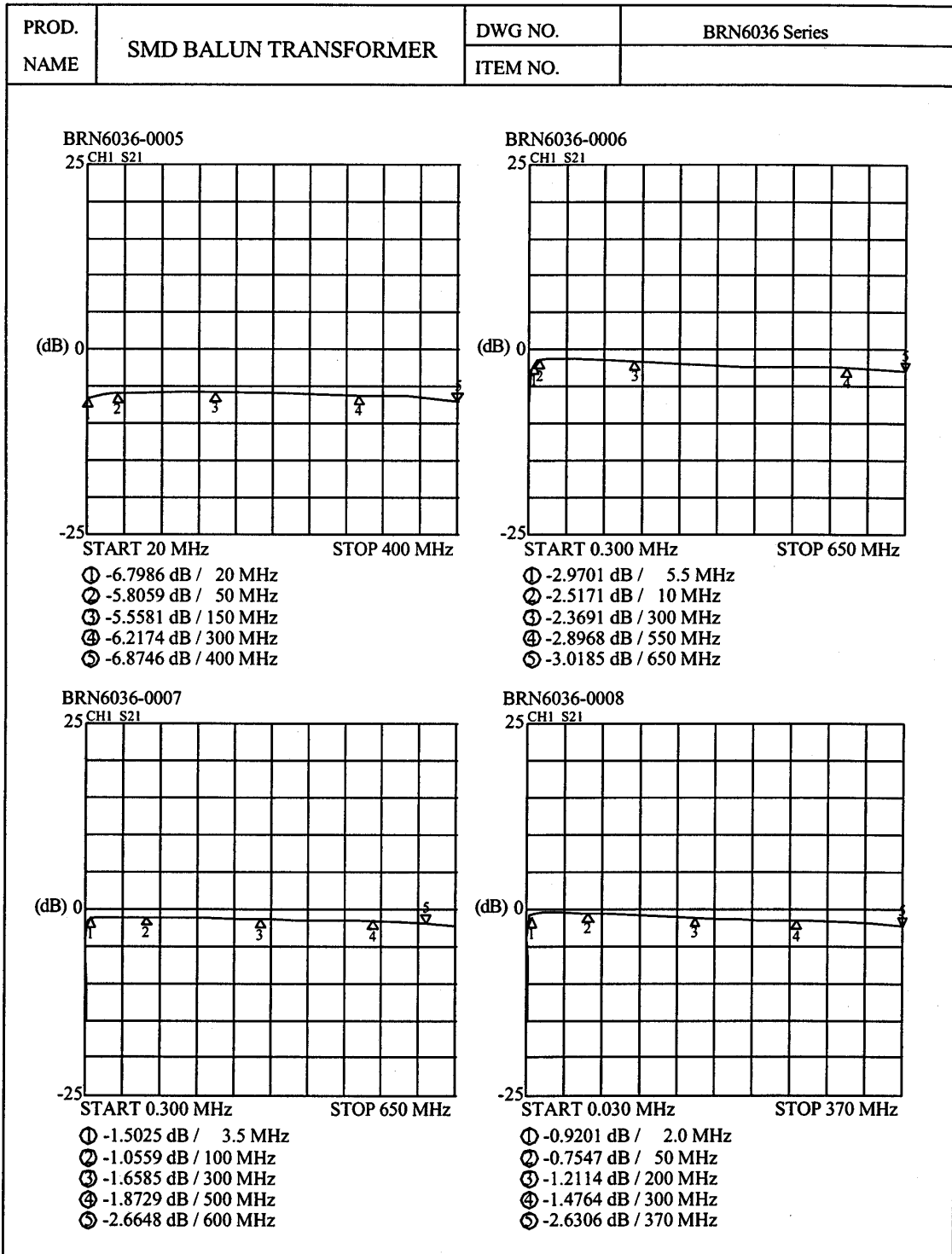

AE-001A

Bourns Inductive Solution

SPECIFICATION FOR APPROVAL

REF :

PAGE: 6

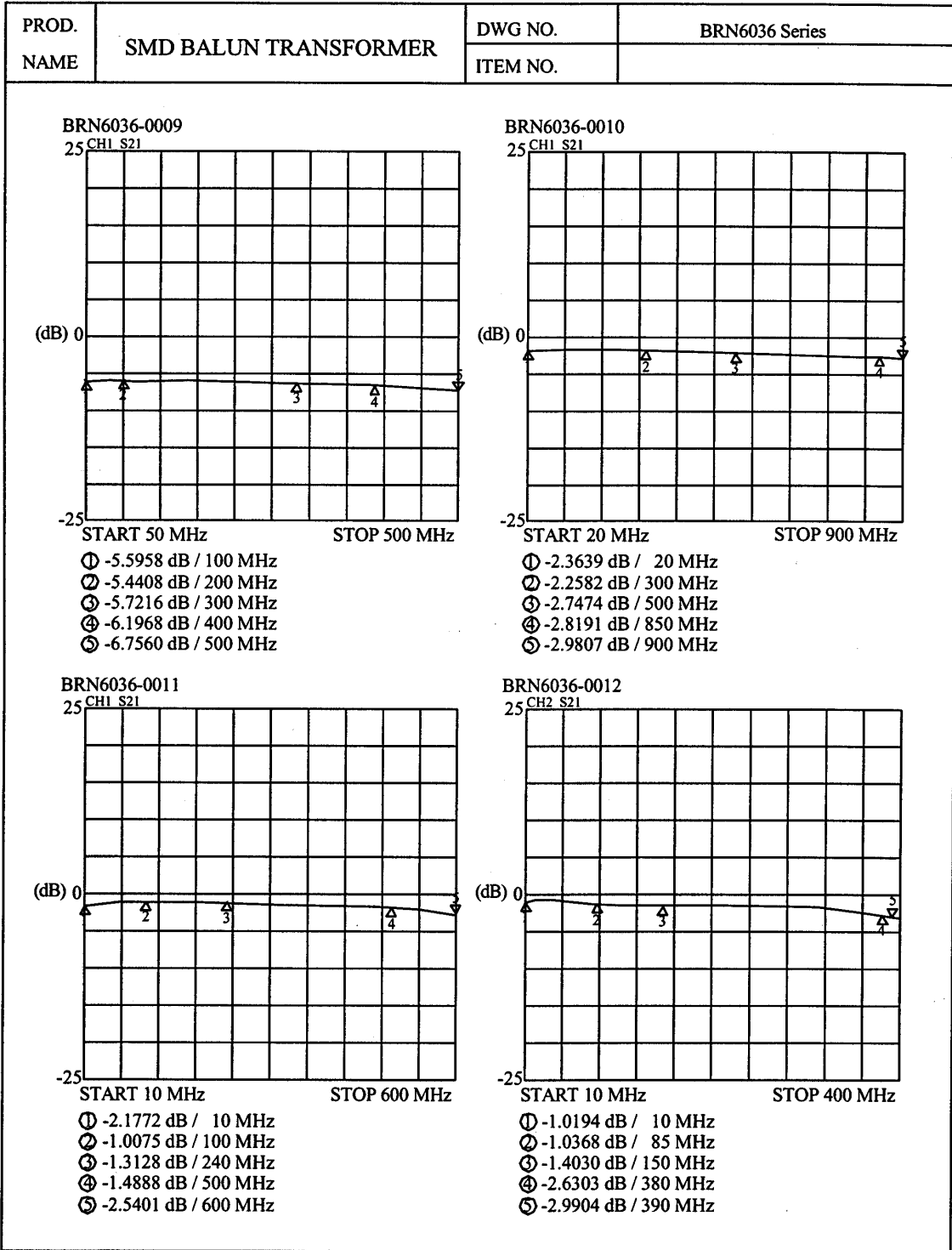

AE-001A

Bourns Inductive Solution

SPECIFICATION FOR APPROVAL

REF :

PAGE: 7

PROD. NAME	SMD BALUN TRANSFORMER	DWG NO.	BRN6036 Series
		ITEM NO.	
<div style="display: flex; justify-content: space-around;"> <div style="width: 48%;"> <p>BRN6036-0013 25 CH1 S21</p> <p>(dB) 0 -25</p> <p>START 0.300 MHz STOP 2500 MHz</p> <ul style="list-style-type: none"> ① -2.4058 dB / 10 MHz ② -2.5636 dB / 1000 MHz ③ -2.4434 dB / 850 MHz ④ -2.5226 dB / 1200 MHz ⑤ -1.3914 dB / 2000 MHz </div> <div style="width: 48%;"> <p>BRN6036-0014 25 CH1 S21</p> <p>(dB) 0 -25</p> <p>START 0.300 MHz STOP 2500 MHz</p> <ul style="list-style-type: none"> ① -2.4797 dB / 6.0 MHz ② -2.8760 dB / 1000 MHz ③ -2.8448 dB / 850 MHz ④ -2.6107 dB / 1200 MHz ⑤ -2.8353 dB / 2000 MHz </div> </div>			
<div style="display: flex; justify-content: space-around;"> <div style="width: 48%;"> <p>BRN6036-0015 25 CH1 S21</p> <p>(dB) 0 -25</p> <p>START 0.300 MHz STOP 2500 MHz</p> <ul style="list-style-type: none"> ① -1.5440 dB / 6.0 MHz ② -2.5877 dB / 600 MHz ③ -2.8402 dB / 850 MHz ④ -1.8911 dB / 1200 MHz ⑤ -2.8265 dB / 1700 MHz </div> <div style="width: 48%;"> <p>BRN6036-0016 25 CH2 S21</p> <p>(dB) 0 -25</p> <p>START 0.300 MHz STOP 2500 MHz</p> <ul style="list-style-type: none"> ① -2.6800 dB / 5.0 MHz ② -2.3717 dB / 600 MHz ③ -1.7034 dB / 1000 MHz ④ -1.4836 dB / 1200 MHz ⑤ -2.5552 dB / 1400 MHz </div> </div>			

AE-001A

Bourns Inductive Solution

SPECIFICATION FOR APPROVAL

REF :

PAGE: 8

PROD. NAME SMD BALUN TRANSFORMER	DWG NO. BRN6036 Series	
	ITEM NO.	

<p>BRN6036-0017 25 CH1 S21</p> <p>(dB) 0 -25</p> <p>START 0.300 MHz STOP 2500 MHz</p> <ul style="list-style-type: none"> ① -1.9838 dB / 5.0 MHz ② -1.7345 dB / 500 MHz ③ -1.1251 dB / 850 MHz ④ -2.1274 dB / 1300 MHz ⑤ -3.0150 dB / 1400 MHz 	<p>BRN6036-0018 25 CH1 S21</p> <p>(dB) 0 -25</p> <p>START 0.300 MHz STOP 2500 MHz</p> <ul style="list-style-type: none"> ① -2.6582 dB / 160 MHz ② -2.0335 dB / 500 MHz ③ -2.8600 dB / 1000 MHz ④ -1.7604 dB / 2000 MHz ⑤ -2.7750 dB / 2400 MHz
<p>BRN6036-0019 25 CH1 S21</p> <p>(dB) 0 -25</p> <p>START 0.300 MHz STOP 2500 MHz</p> <ul style="list-style-type: none"> ① -2.8956 dB / 60 MHz ② -1.9037 dB / 500 MHz ③ -2.7778 dB / 850 MHz ④ -1.4123 dB / 1700 MHz ⑤ -2.6534 dB / 2250 MHz 	<p>BRN6036-0020 25 CH2 S21</p> <p>(dB) 0 -25</p> <p>START 0.300 MHz STOP 2500 MHz</p> <ul style="list-style-type: none"> ① -2.8621 dB / 30 MHz ② -1.1315 dB / 500 MHz ③ -0.9943 dB / 1000 MHz ④ -1.4555 dB / 1400 MHz ⑤ -2.8334 dB / 1550 MHz

AE-001A

Bourns Inductive Solution