



Chipsmall Limited consists of a professional team with an average of over 10 year of expertise in the distribution of electronic components. Based in Hongkong, we have already established firm and mutual-benefit business relationships with customers from,Europe,America and south Asia,supplying obsolete and hard-to-find components to meet their specific needs.

With the principle of “Quality Parts,Customers Priority,Honest Operation,and Considerate Service”,our business mainly focus on the distribution of electronic components. Line cards we deal with include Microchip,ALPS,ROHM,Xilinx,Pulse,ON,Everlight and Freescale. Main products comprise IC,Modules,Potentiometer,IC Socket,Relay,Connector.Our parts cover such applications as commercial,industrial, and automotives areas.

We are looking forward to setting up business relationship with you and hope to provide you with the best service and solution. Let us make a better world for our industry!



Contact us

Tel: +86-755-8981 8866 Fax: +86-755-8427 6832

Email & Skype: info@chipsmall.com Web: www.chipsmall.com

Address: A1208, Overseas Decoration Building, #122 Zhenhua RD., Futian, Shenzhen, China





**Pb-free
HEAT**



1211C Series

Bi-color Type (1.6 X 1.5 mm)

Features

Package	Bi-Color Type(1.6 x 1.5mm), Milky White resin
Product features	<ul style="list-style-type: none"> • Outer Dimension 1.6 x 1.5 x 0.7mm (L x W x H) • Temperature range Storage Temperature : -40°C~100°C Operating Temperature : -40°C~85°C(FRYPY) -30°C~85°C(BRBG, BRPG, BRPY) • Lead-free soldering compatible • RoHS compliant • Low current type(5mA) is available.(FRYPY1211C-0005) Power Consumption : 55% reduction Compared with 20mA standard current type.
Dominant wavelength	Green : 558nm(BG),567nm(PG) Yellow Green : 572nm(PY, YPY) Red : 626nm(FR),647nm(BR)
Half Intensity Angle	BG,PG,PY : $\theta_x = 168 \text{ deg.}, \theta_y = 139 \text{ deg.}$ BR : $\theta_x = 150 \text{ deg.}, \theta_y = 140 \text{ deg.}$ FR , YPY : $\theta_x = 115 \text{ deg.}, \theta_y = 140 \text{ deg.}$
Die materials	FR , YPY : AlGaInP BG,PG,PY : GaP BR : GaAlAs
Rank grouping parameter	Sorted by luminous intensity per rank taping
Assembly method	Auto pick & place machine (Auto Mounter)
Soldering methods	Reflow soldering and manual soldering
Taping and reel	4,000pcs per reel in a 8mm width tape. (Standard) Reel diameter: ϕ 180mm
ESD	More than 2kV(HBM)

Recommended Applications

Communication Machine, Electric Household Appliances, OA/FA, Other General Applications

Color chart and Luminous Intensity

(Ta=25°C)

Part No.	Die Name	Material	Emitted Color	Lens Color	Dominant Wavelength λd (nm)		Luminous Intensity Iv (mcd)		
					TYP.	IF	MIN.	TYP.	IF
					FRYPY1211C	FR	AlGaInP	Red	Milky White
YPY	Yellow Green	572	20	25.0		50.0		20	
BRBG1211C	BR	GaAlAs	Red	647	20	7.0	11.7	20	
	BG	GaP	Green	558	20	1.7	2.4	20	
BRPG1211C	BR	GaAlAs	Red	647	20	7.0	11.7	20	
	PG	GaP	Green	567	20	4.5	6.4	20	
BRPY1211C	BR	GaAlAs	Red	647	20	7.0	11.7	20	
	PY	GaP	Yellow Green	572	20	7.0	11.7	20	

Low current type

Part No.	Die Name	Material	Emitted Color	Lens Color	Dominant Wavelength λd (nm)		Luminous Intensity Iv (mcd)		
					TYP.	IF	MIN.	TYP.	IF
					FRYPY1211C-0005	FR	AlGaInP	Red	Milky White
YPY	Yellow Green	570	5	6.3		12.0		5	

Absolute Maximum Ratings

(Ta=25°C)

Item	Symbol	Absolute Maximum Ratings						Unit
		BG	PG	PY	YPY	FR	BR	
Power Dissipation	P_d	70	70	70	78	81	70	mW
Continuous forward current	I_F	25	25	25	30	30	25	mA
Repetitive peak forward current ^{※1}	I_{FRM}	60	60	60	100	100	60	mA
Derating linearly (Ta=25°C or higher)	ΔI_F	0.36	0.36	0.36	0.43	0.43	0.36	mA/°C
	ΔI_{FRM}	0.86	0.86	0.86	1.43	1.43	0.86	mA/°C
Reverse Voltage	V_R	4	4	4	5	5	4	V
Operating Temperature	T_{opr}	-30~+85			-40~+85		-30~+85	°C
Storage Temperature	T_{stg}	-40~+100						°C

Low current type

Item	Symbol	Absolute Maximum Ratings		Unit
		YPY	FR	
Power Dissipation	P_d	36	36	mW
Continuous forward current	I_F	15	15	mA
Repetitive peak forward current ^{※1}	I_{FRM}	48	48	mA
Derating linearly (Ta=25°C or higher)	ΔI_F	0.21	0.21	mA/°C
	ΔI_{FRM}	0.69	0.69	mA/°C
Reverse Voltage	V_R	5	5	V
Operating Temperature	T_{opr}	-40~+85		°C
Storage Temperature	T_{stg}	-40~+100		°C

※1 I_{FRM} Measurement condition : Pulse Width ≤ 1 ms., Duty $\leq 1/20$.

※ The ratings specified above are under the condition that only one diode is lit.
50% Max. of each rating shall be applied when two diodes are lit simultaneously.

Electro-Optical Characteristics

(Ta=25°C)

Item	Conditions	Symbol	Characteristics							Unit
				BG	PG	PY	YPY	FR	BR	
Forward Voltage	I _F =20mA	V _F	TYP.	2.1	2.1	2.1	2.1	1.9	1.7	V
			MAX.	2.8	2.8	2.8	2.6	2.4	2.3	
Reverse Current	V _R =5V	I _R	MAX.	-	-	-	100	100	-	μ A
	V _R =4V			100	100	100	-	-	100	
Peak Wavelength	I _F =20mA	λ _p	TYP.	555	560	570	575	635	660	nm
Dominant Wavelength	I _F =20mA	λ _d	TYP.	558	567	572	572	626	647	nm
Spectral Line Half Width	I _F =20mA	Δλ	TYP.	30	30	30	15	15	30	nm
Half Intensity Angle	I _F =20mA	2θ 1/2	TYP. (θ x)	168	168	168	115	115	150	deg.
			TYP. (θ y)	139	139	139	140	140	140	

Low current type

Item	Conditions	Symbol	Characteristics			Unit
				YPY	FR	
Forward Voltage	I _F =5mA	V _F	TYP.	1.95	1.85	V
			MAX.	2.4	2.4	
Reverse Current	V _R =5V	I _R	MAX.	100	100	μ A
Peak Wavelength	I _F =5mA	λ _p	TYP.	572	635	nm
Dominant Wavelength	I _F =5mA	λ _d	TYP.	570	626	nm
Spectral Line Half Width	I _F =5mA	Δλ	TYP.	15	15	nm
Half Intensity Angle	I _F =5mA	2θ 1/2	TYP. (θ x)	115	115	deg.
			TYP. (θ y)	140	140	

Luminous Intensity Rank

(Ta=25°C)

Rank	I _v (mcd)															
	FRYPY1211C				BRBG1211C				BRPG1211C				BRPY1211C			
	IF = 20mA				IF = 20mA				IF = 20mA				IF = 20mA			
	YPY		FR		BG		BR		PG		BR		PY		BR	
	MIN.	MAX.	MIN.	MAX.	MIN.	MAX.	MIN.	MAX.	MIN.	MAX.	MIN.	MAX.	MIN.	MAX.	MIN.	MAX.
AA	25	40	40	64	1.7	3.4	7.0	14.0	4.5	9.0	7.0	14.0	7.0	14.0	7.0	14.0
AB	40	64	40	64	2.4	4.8	7.0	14.0	6.4	12.8	7.0	14.0	9.9	19.8	7.0	14.0
AC	64	100	40	64	3.4	6.8	7.0	14.0	9.0	18.0	7.0	14.0	14.0	28.0	7.0	14.0
BA	25	40	64	100	1.7	3.4	9.9	19.8	4.5	9.0	9.9	19.8	7.0	14.0	9.9	19.8
BB	40	64	64	100	2.4	4.8	9.9	19.8	6.4	12.8	9.9	19.8	9.9	19.8	9.9	19.8
BC	64	100	64	100	3.4	6.8	9.9	19.8	9.0	18.0	9.9	19.8	14.0	28.0	9.9	19.8
CA	25	40	100	160												
CB	40	64	100	160												
CC	64	100	100	160												

※ Please contact our sales staff concerning rank designation.

Low current type

Rank	I _v (mcd)			
	FRYPY1211C-0005			
	IF = 5mA			
	YPY		FR	
	MIN.	MAX.	MIN.	MAX.
AA	6.3	10.0	14.0	22.0
AB	10.0	16.0	14.0	22.0
AC	16.0	25.0	14.0	22.0
BA	6.3	10.0	22.0	36.0
BB	10.0	16.0	22.0	36.0
BC	16.0	25.0	22.0	36.0
CA	6.3	10.0	36.0	57.0
CB	10.0	16.0	36.0	57.0
CC	16.0	25.0	36.0	57.0

※ Please contact our sales staff concerning rank designation.

Color Tone Groups (λd)

(Ta=25°C)

Rank	Dominant Wavelength λd (nm)	
	FRYPY1211C	
	YPY	
	$I_f=20mA$	
	MIN.	MAX.
A	568	572
B	572	576

Low current type

Rank	Dominant Wavelength λd (nm)	
	FRYPY1211C-0005	
	YPY	
	$I_f=5mA$	
	MIN.	MAX.
A	566.5	570.5
B	570.5	574.5

Technical Data(FR, YPY)

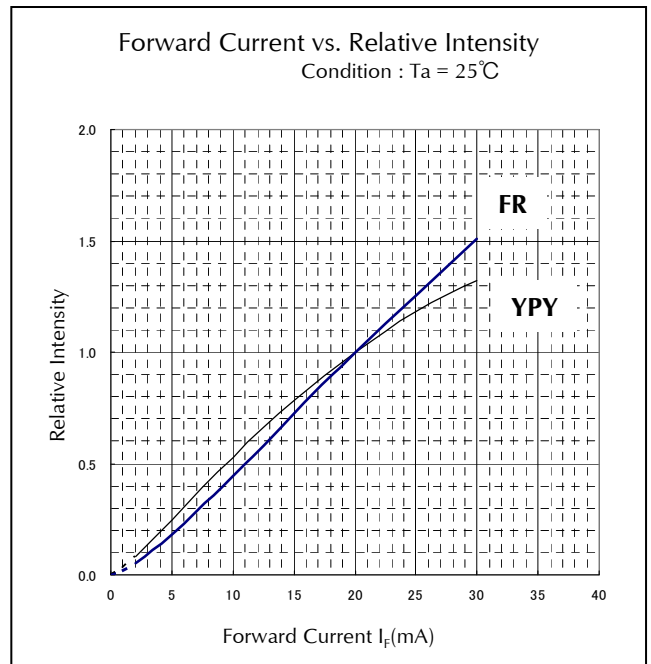
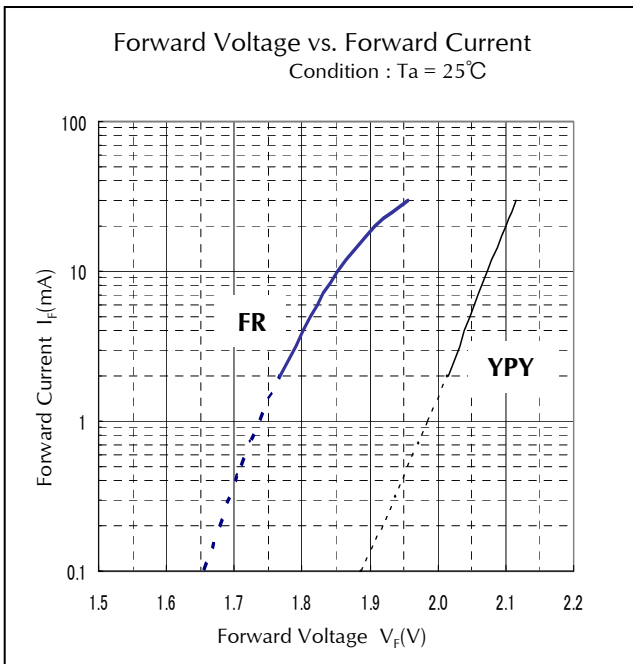
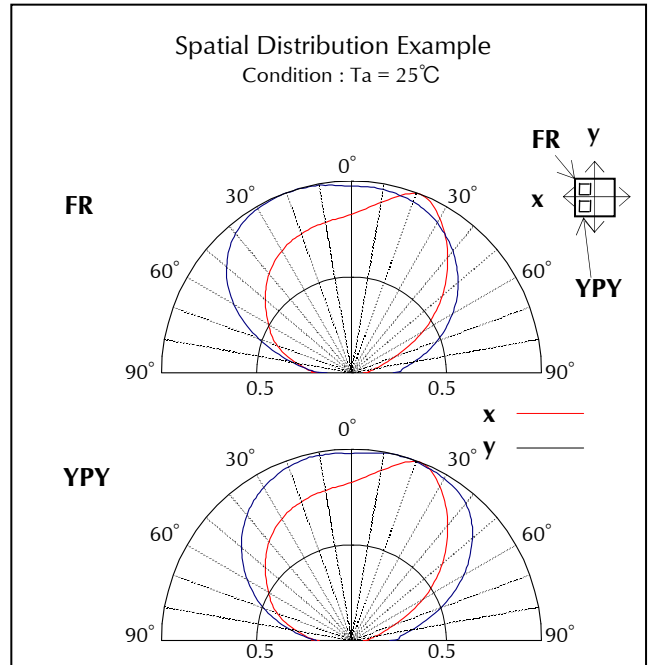
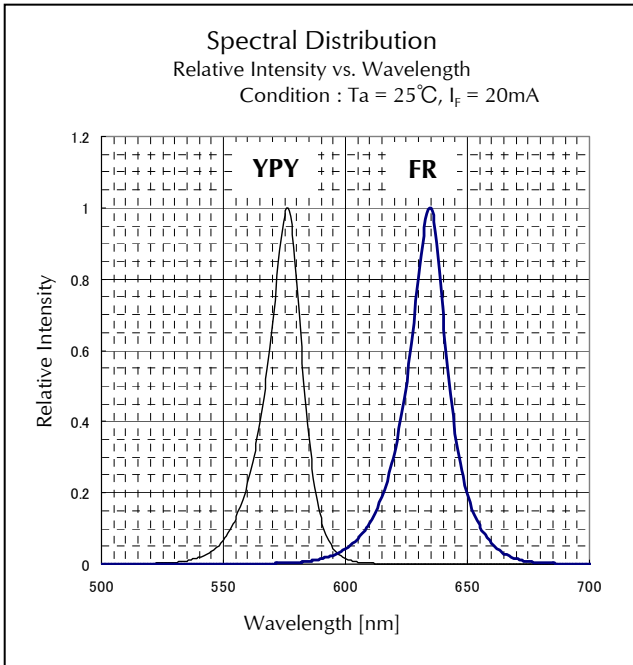

Technical Data(FR, YPY)

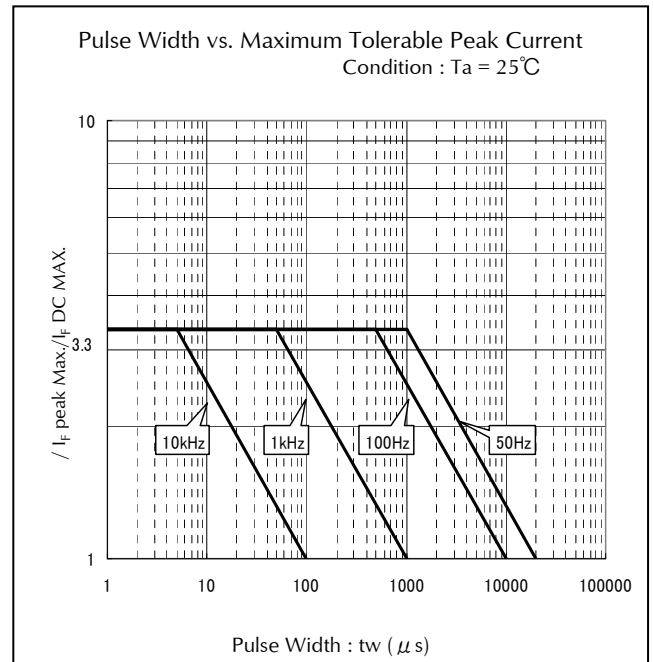
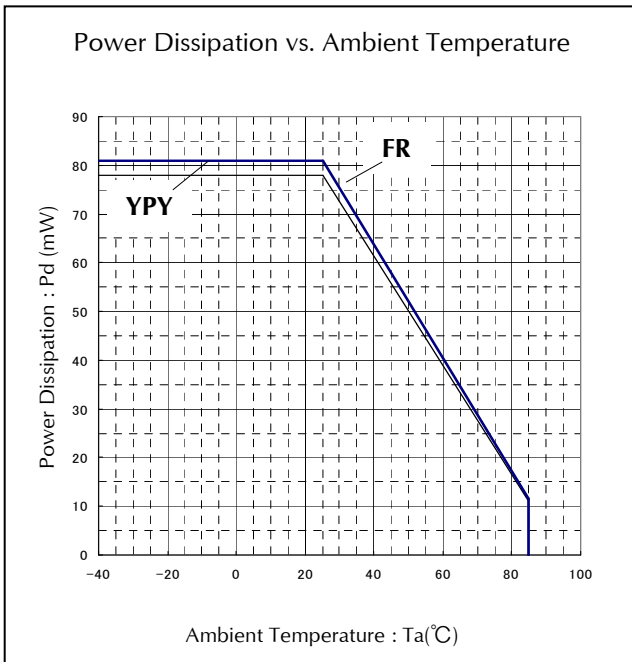
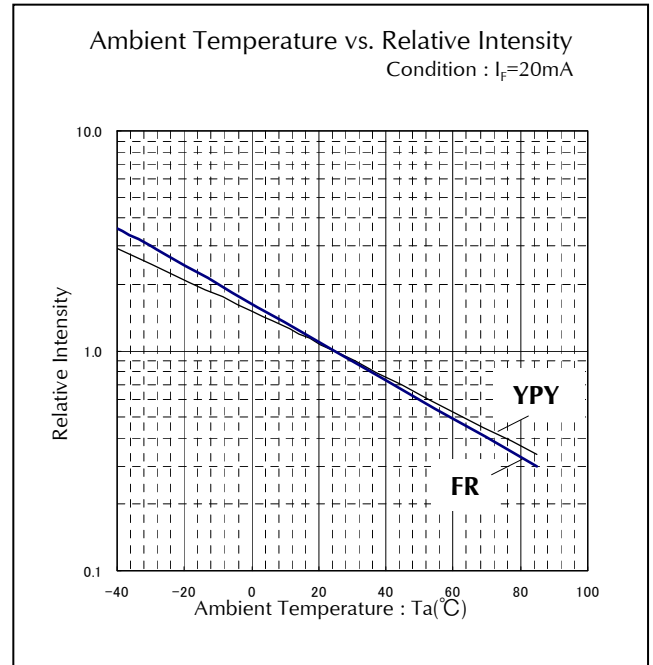
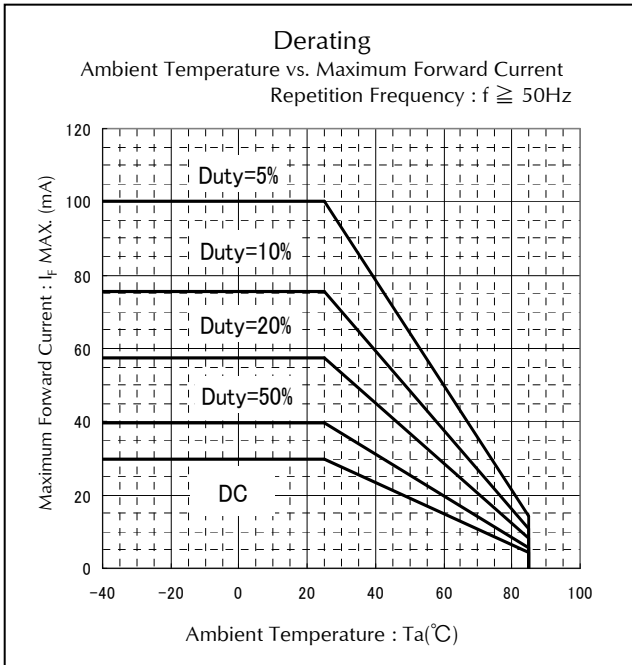

Technical Data(FR, YPY)

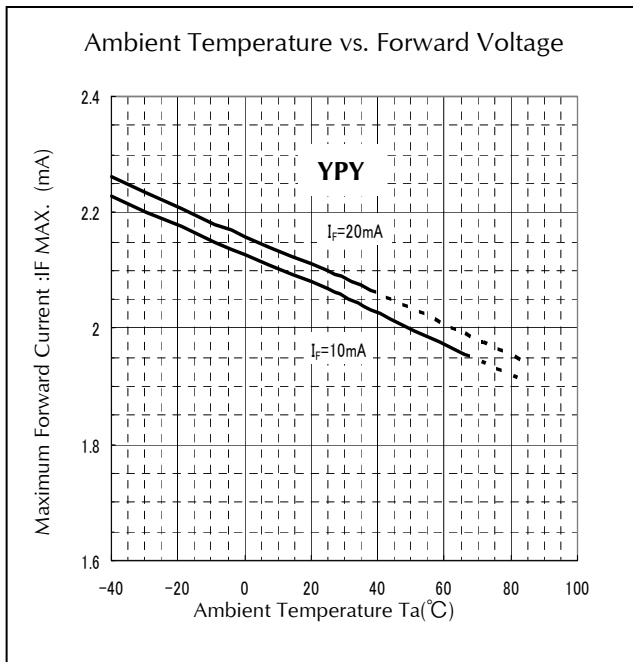
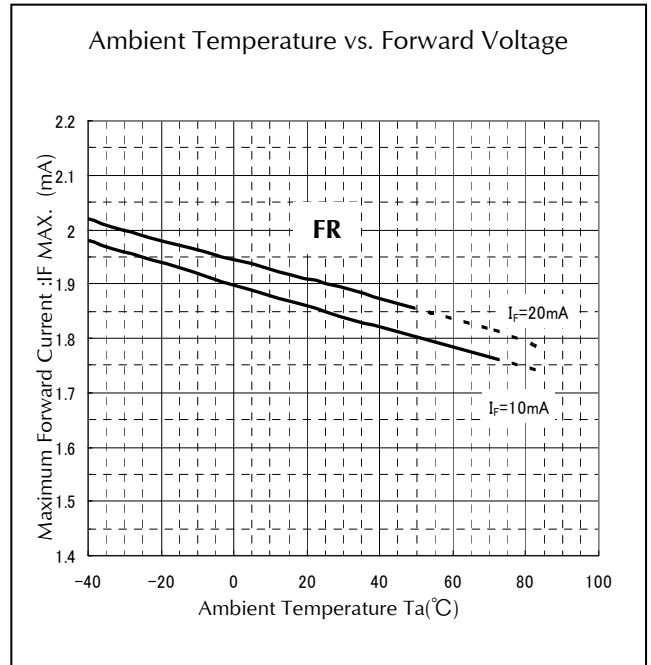
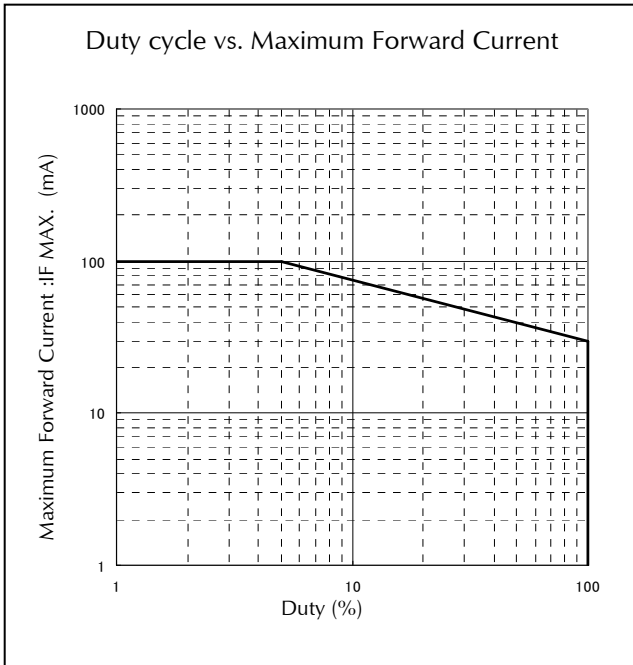

Technical Data(FR, YPY) Low current type(I_F=5mA)

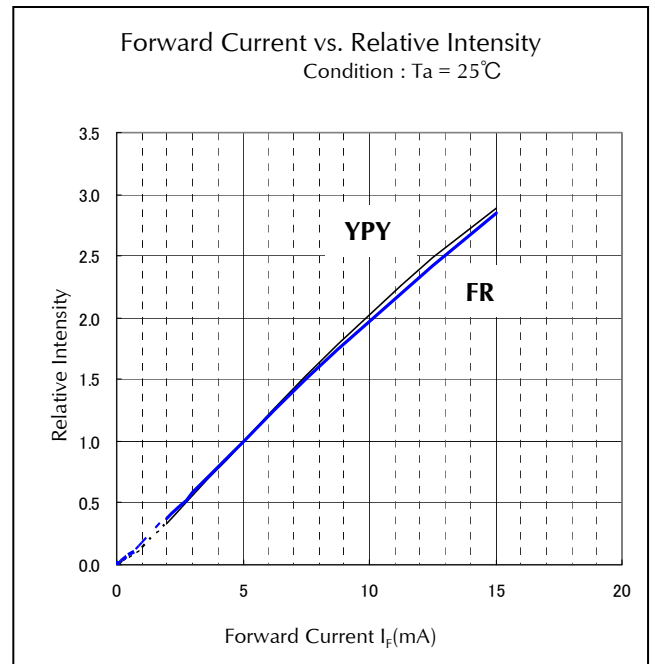
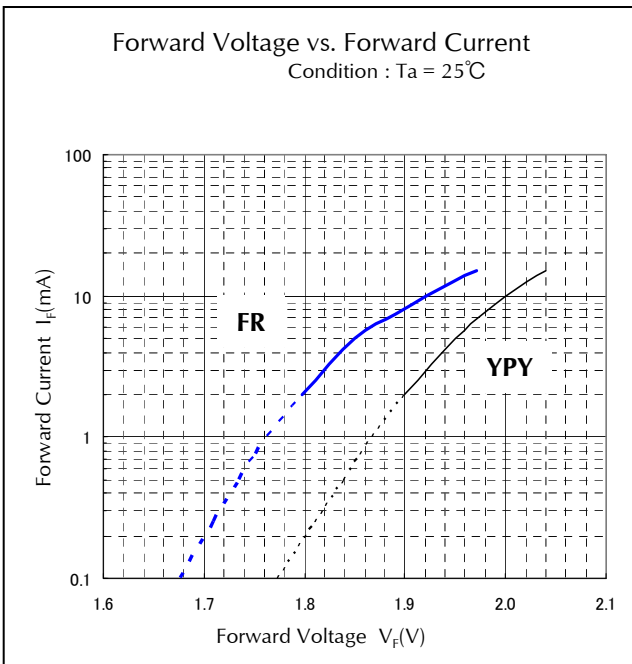
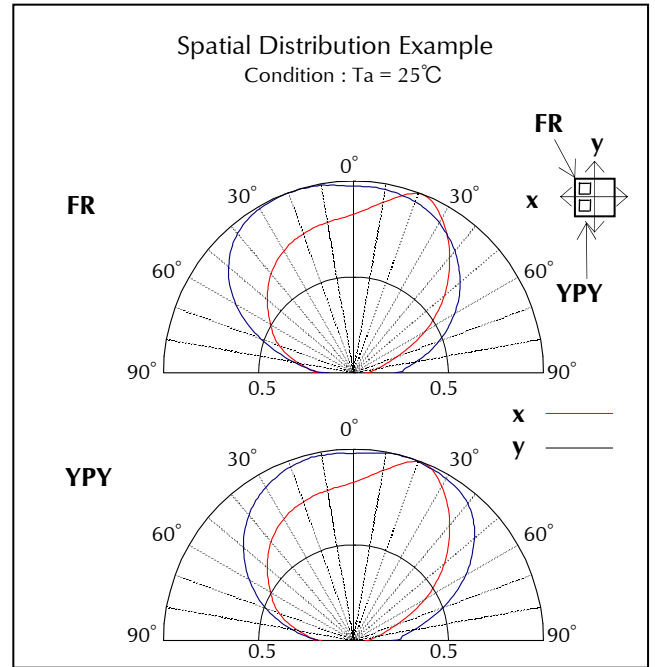
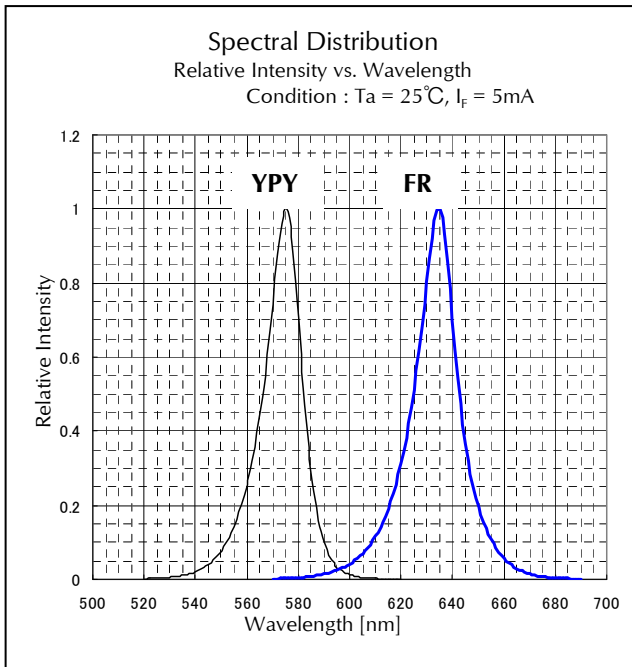

Technical Data(FR, YPY) Low current type(IF=5mA)

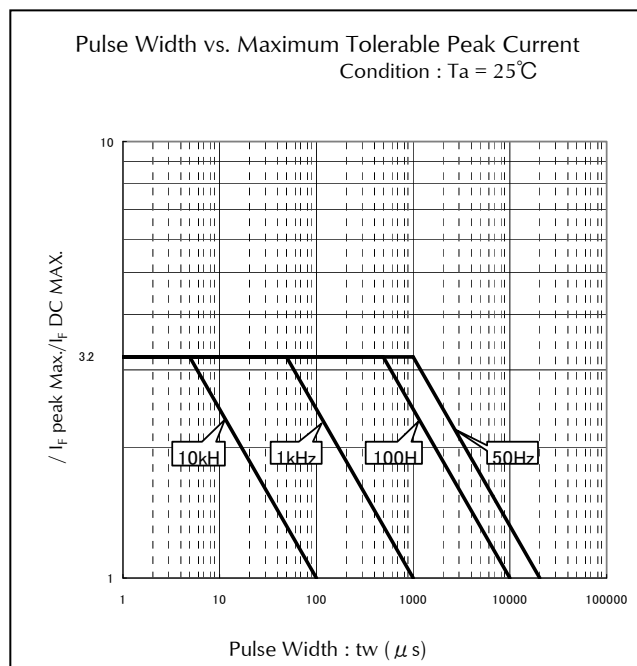
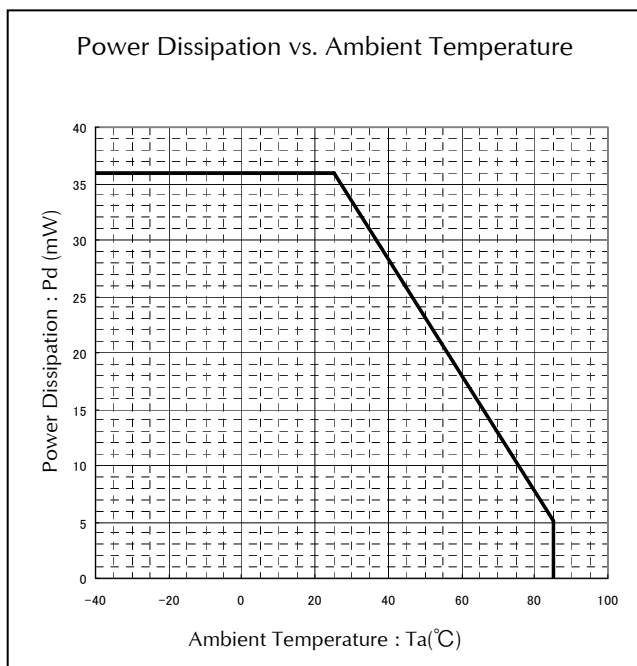
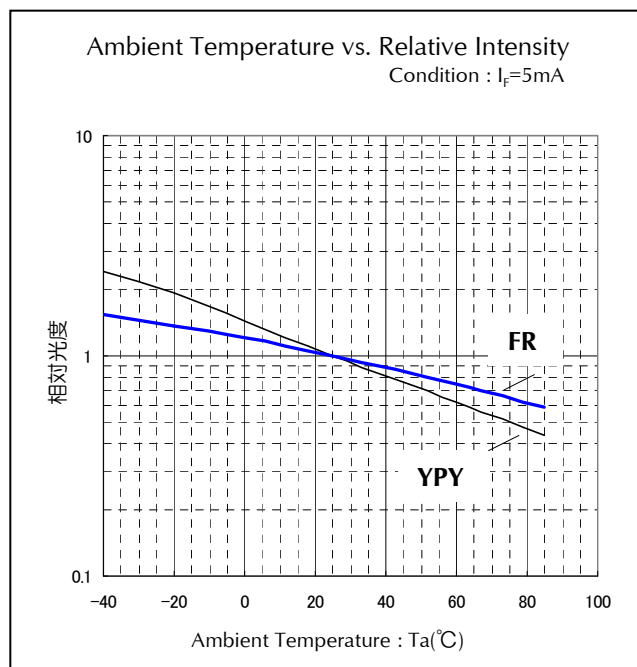
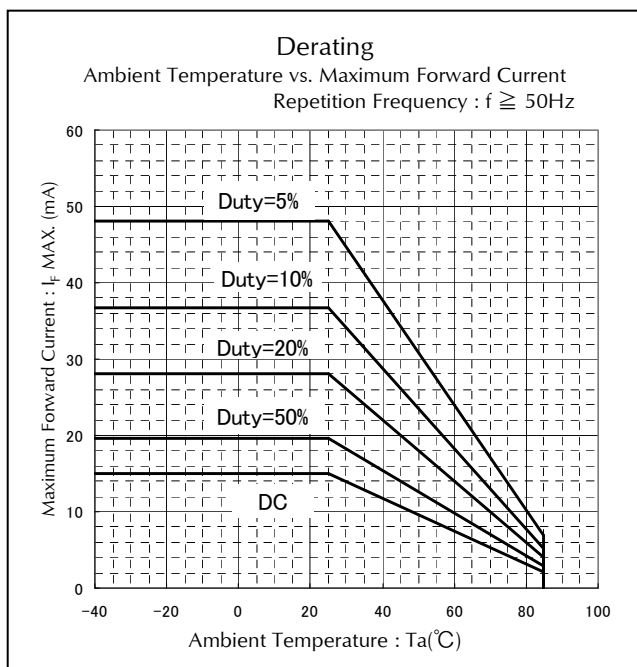

Technical Data(FR, YPY) Low current type(IF=5mA)

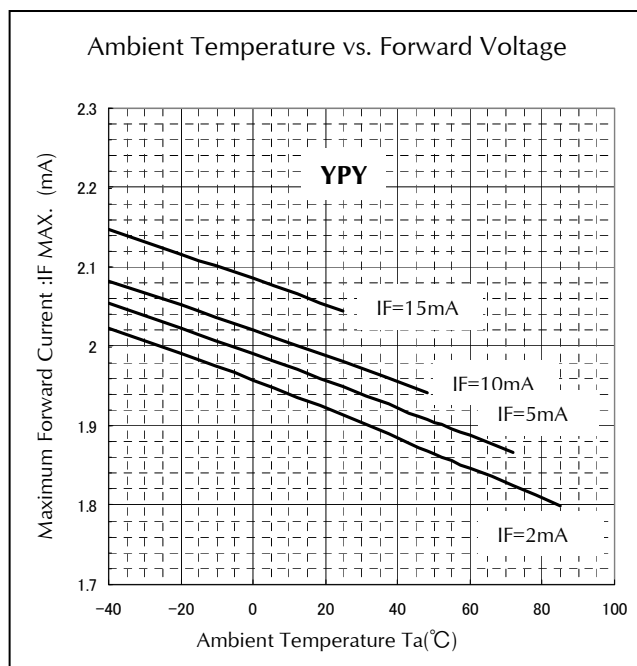
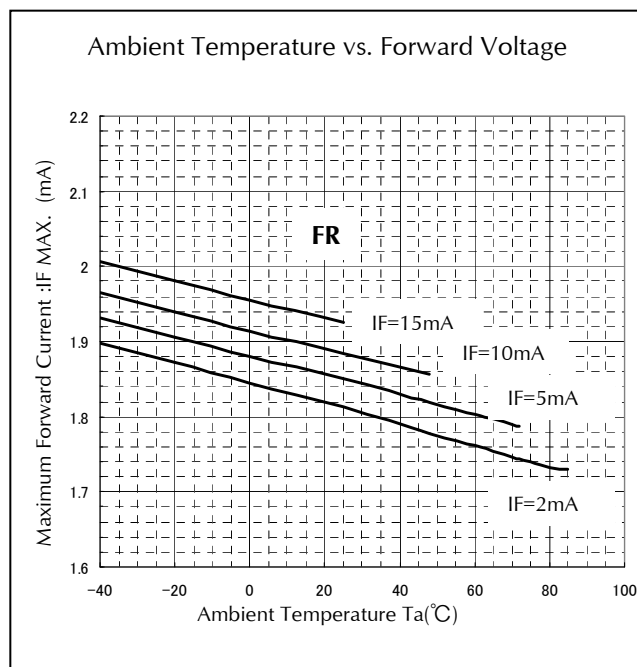
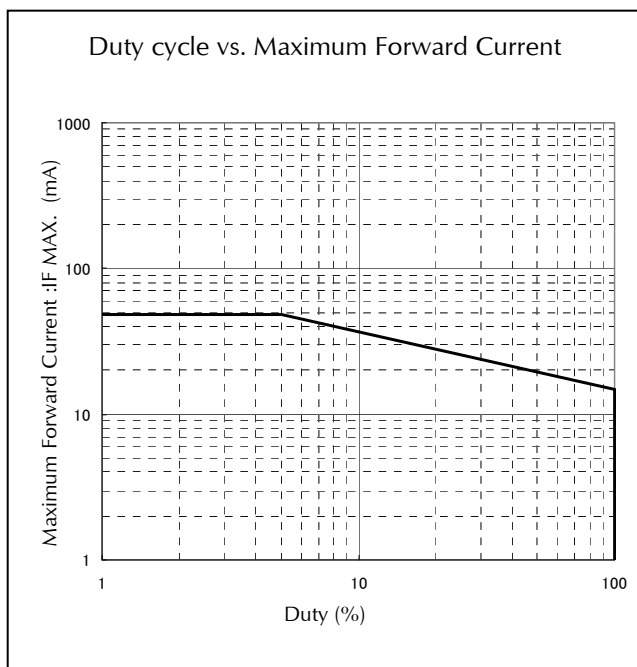

Technical Data(BR,BG)

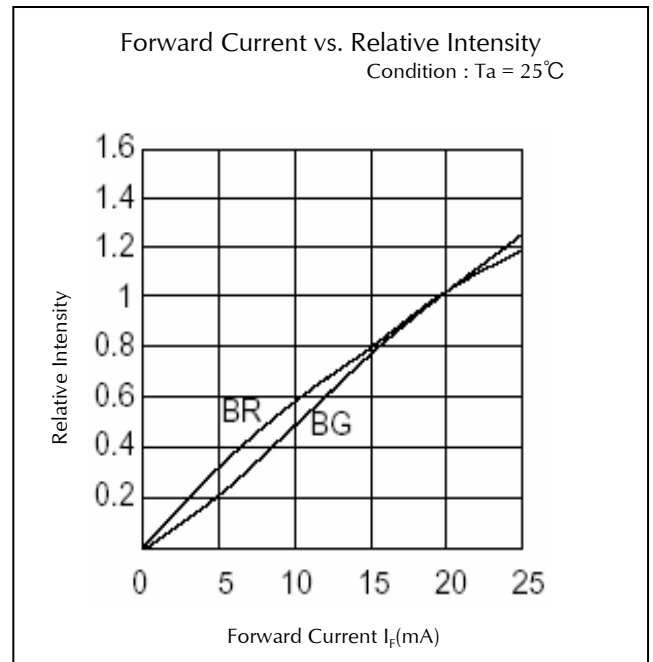
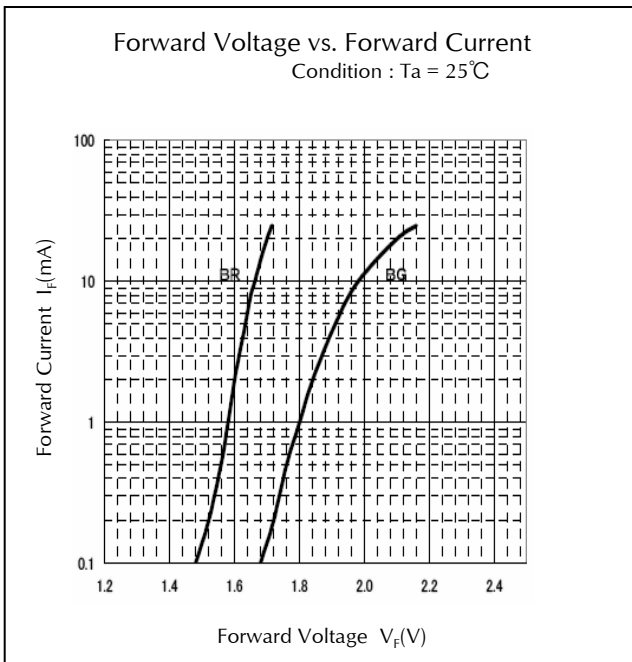
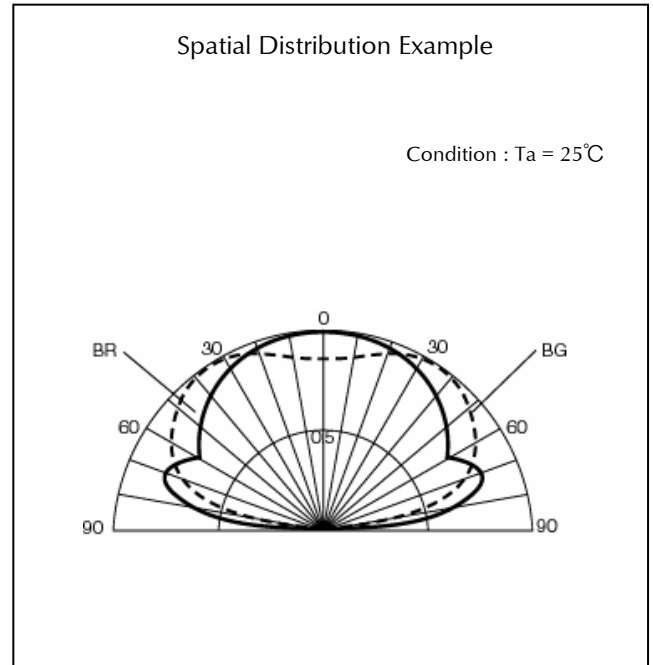
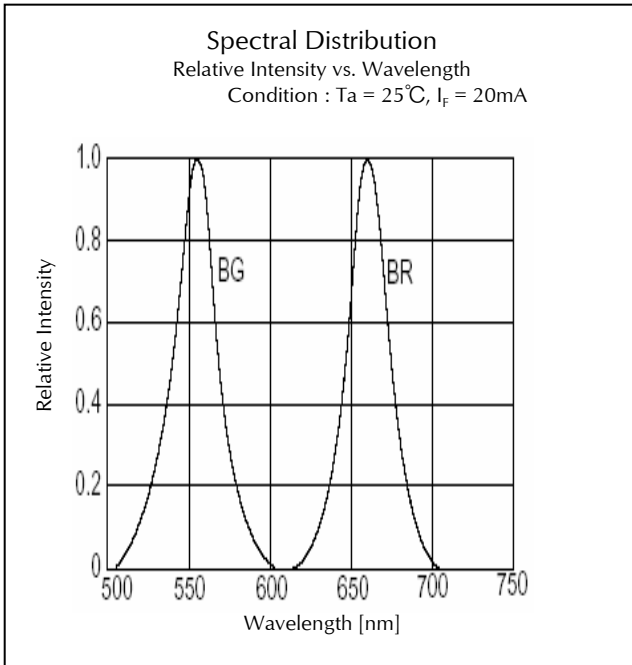

Technical Data(BR,BG)

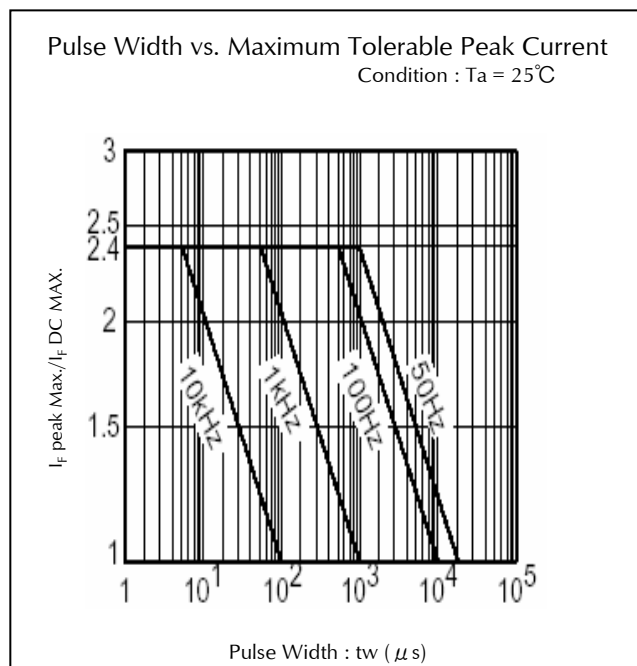
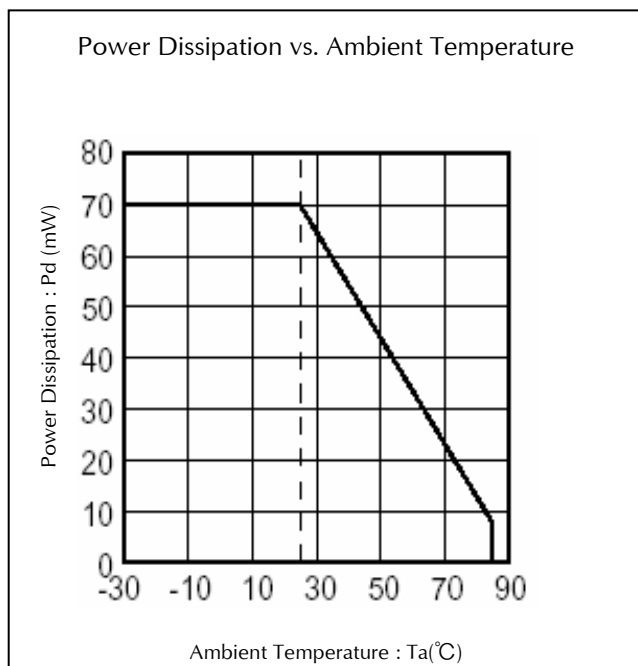
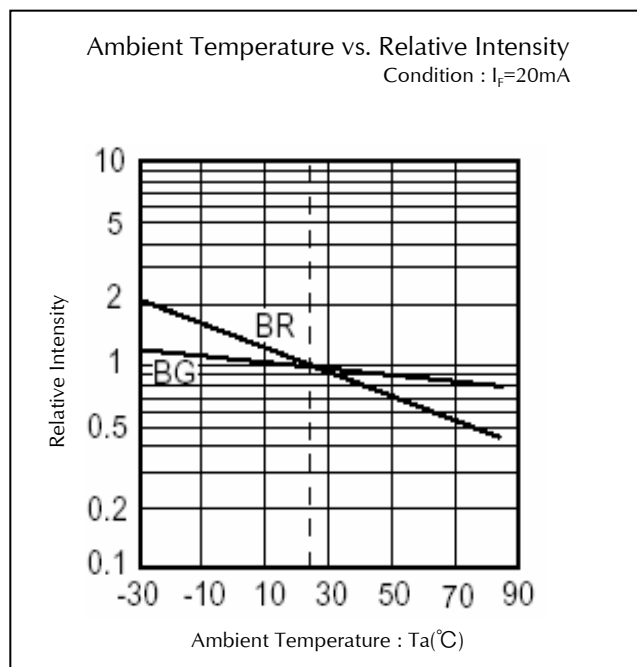
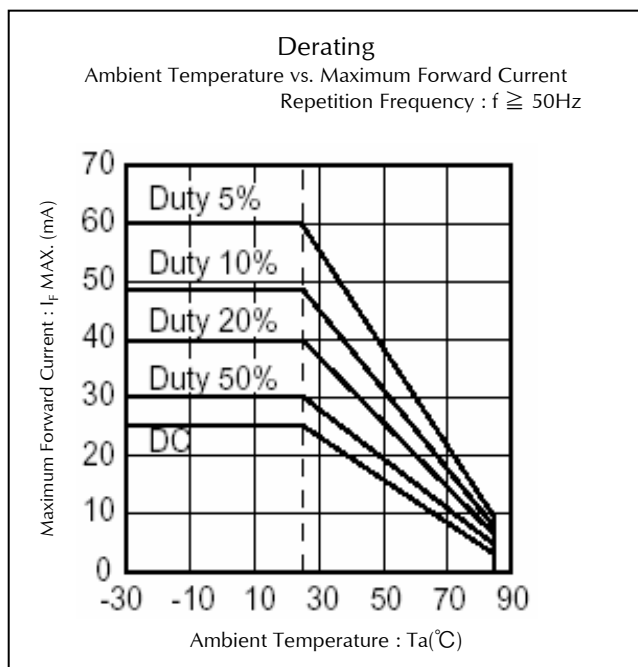

Technical Data(BR,PG)

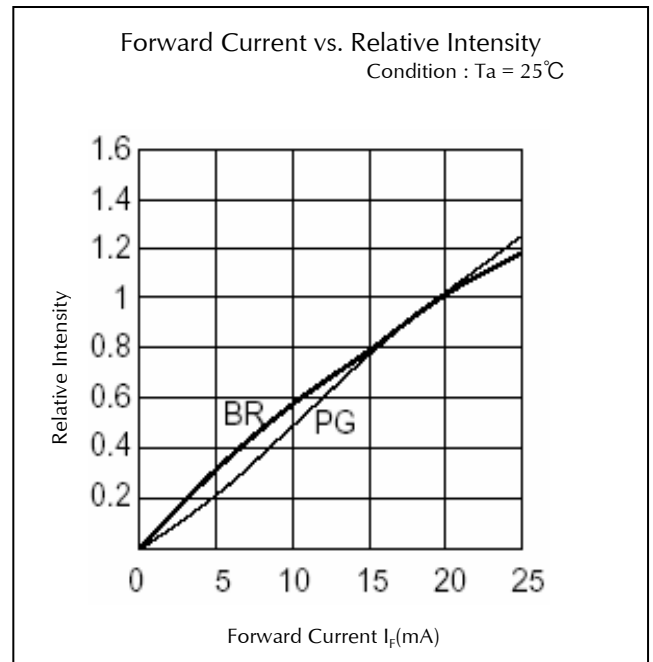
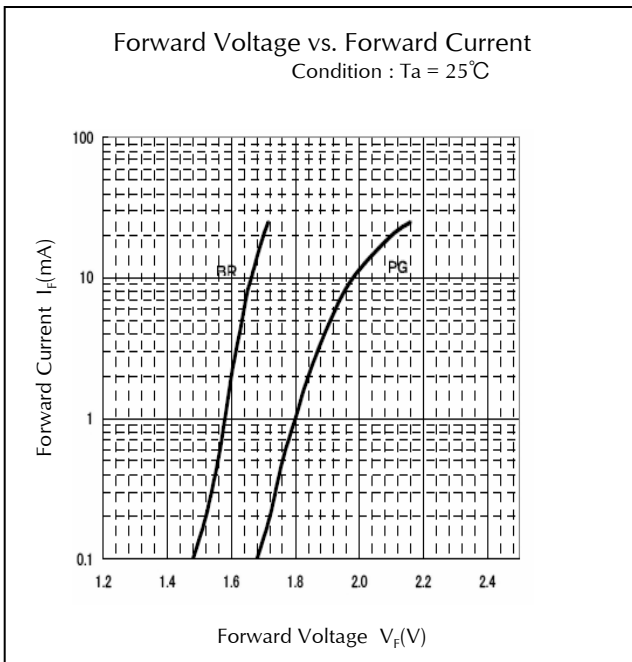
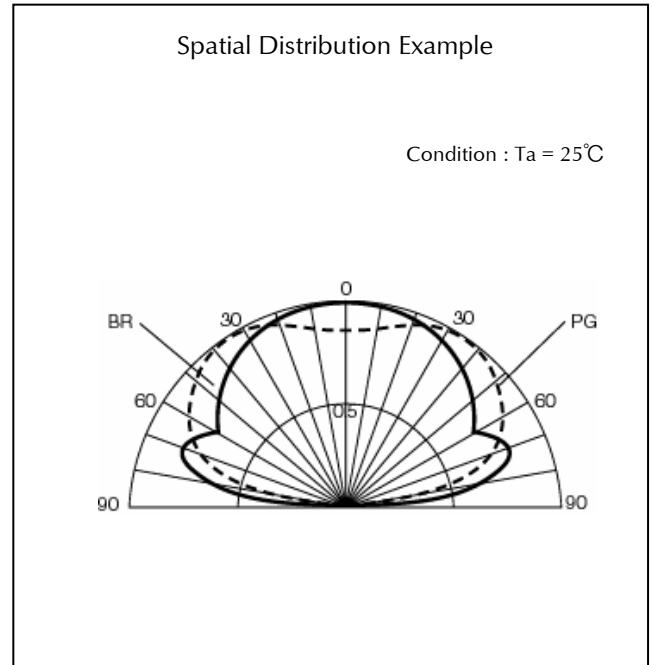
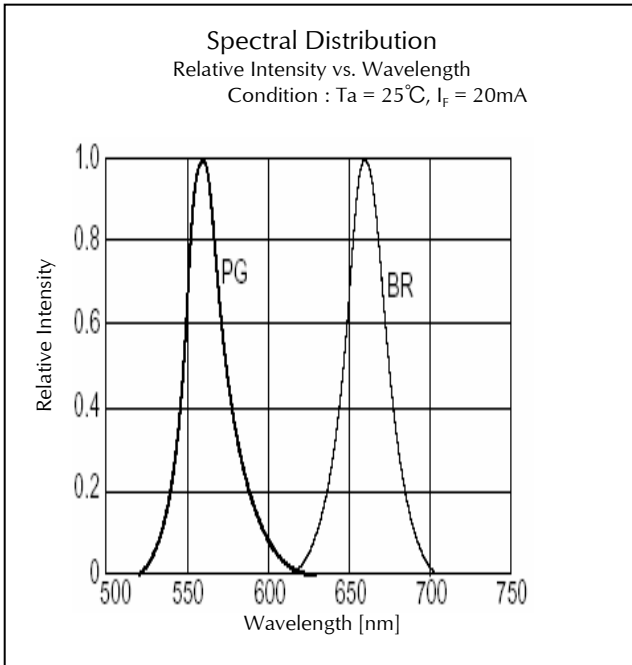

Technical Data(BR,PG)

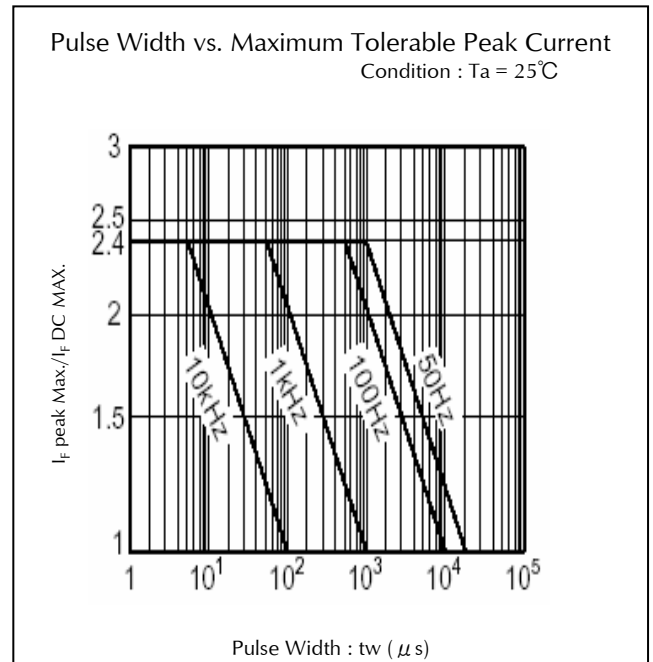
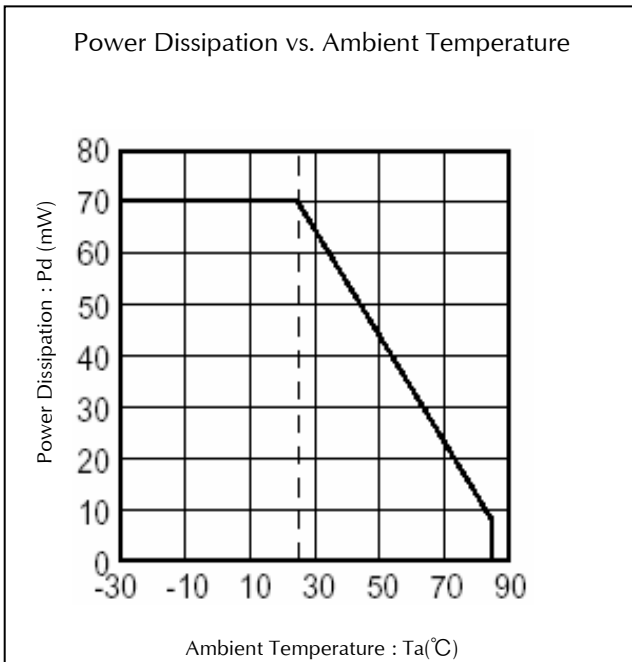
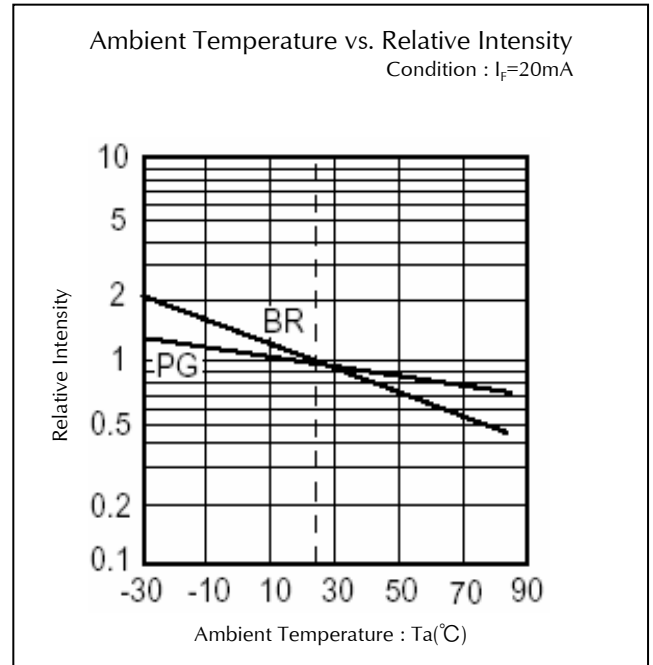
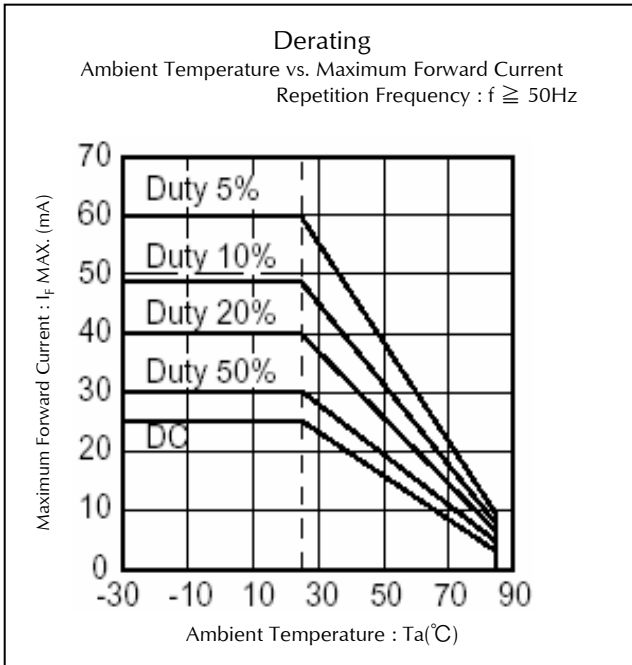

Technical Data(BR,PY)

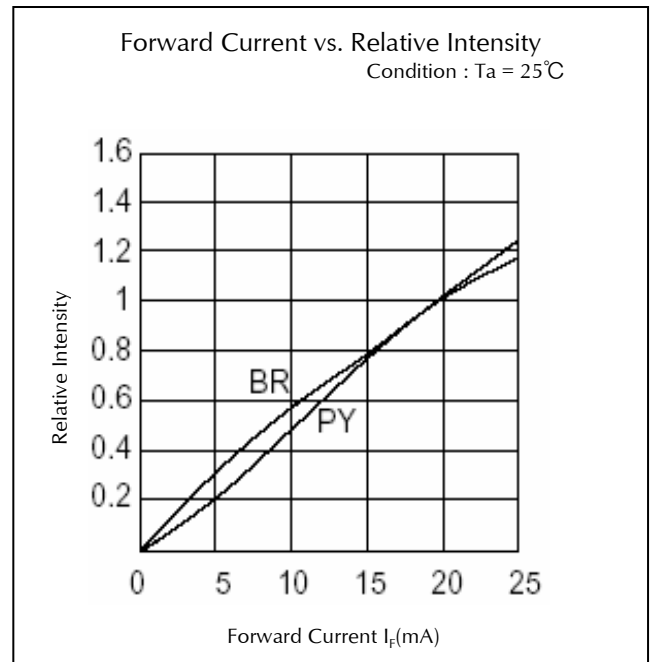
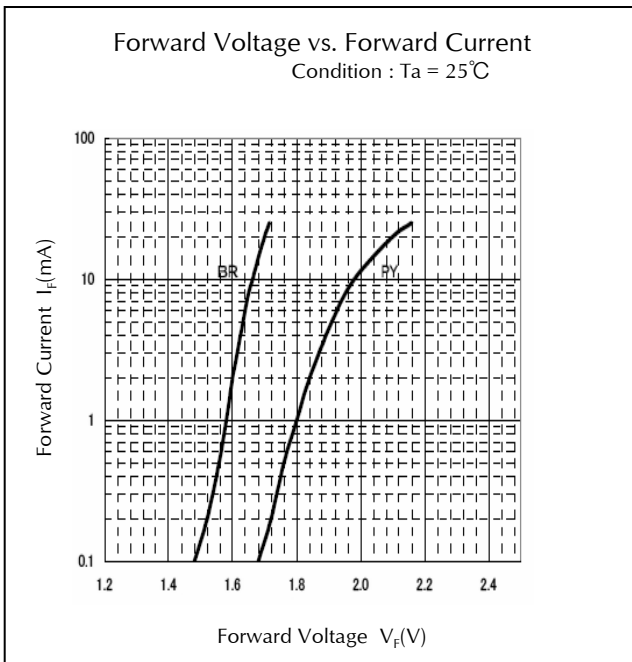
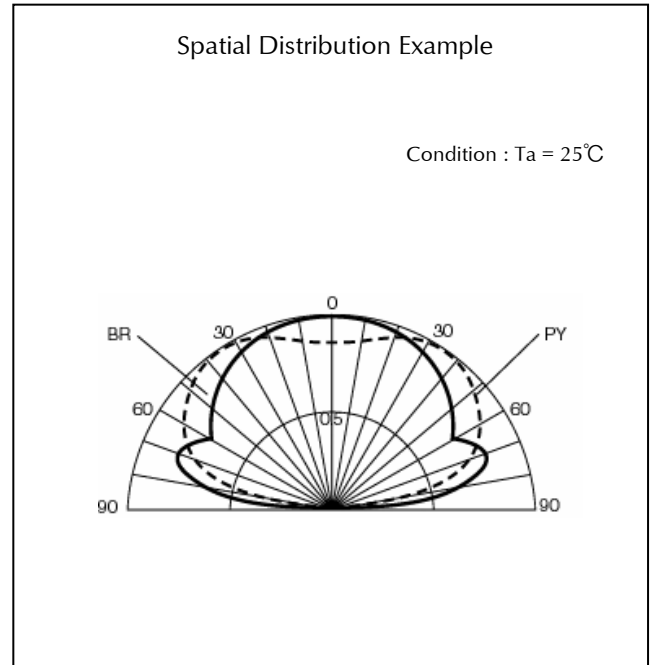
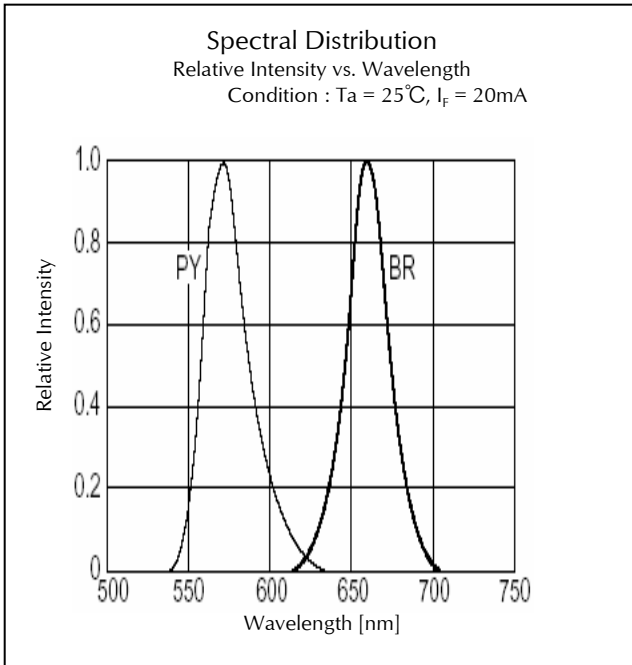

Technical Data(BR,PY)

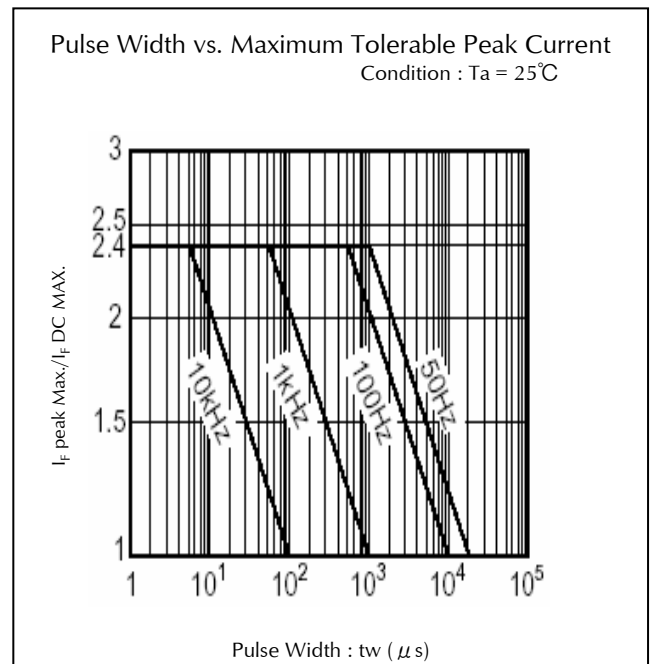
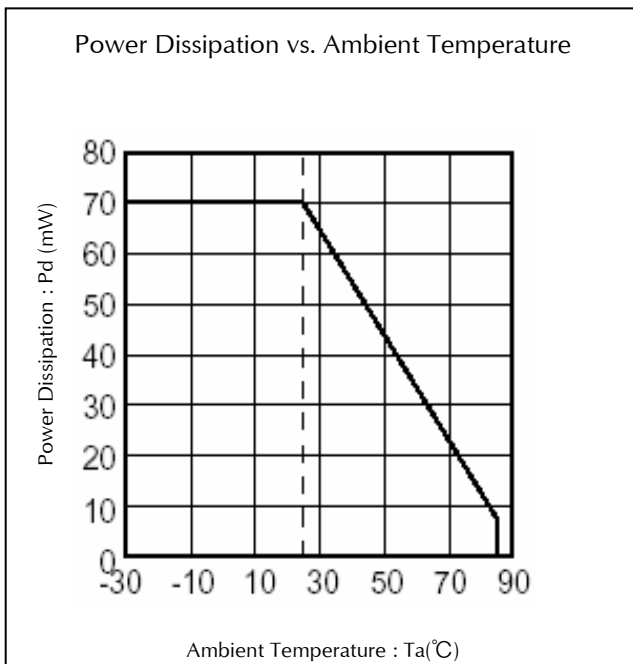
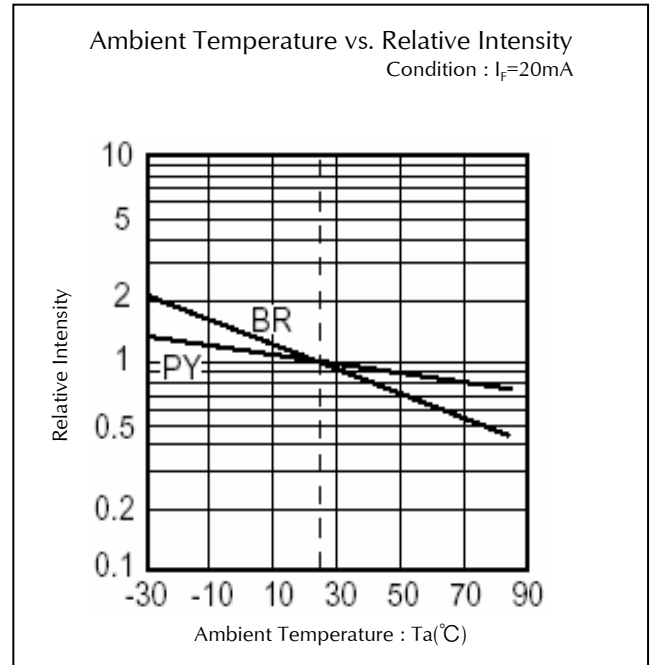
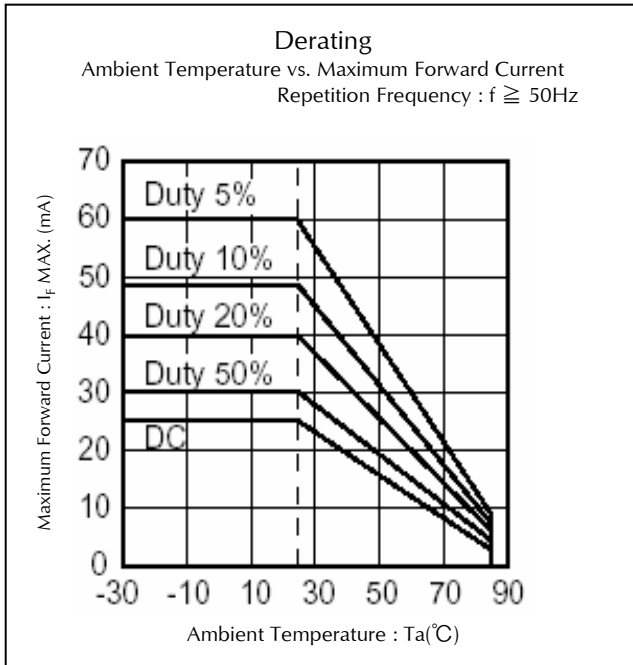

Package Dimensions(FRYPY)

(Unit: mm)

Weight: (3.0)mg

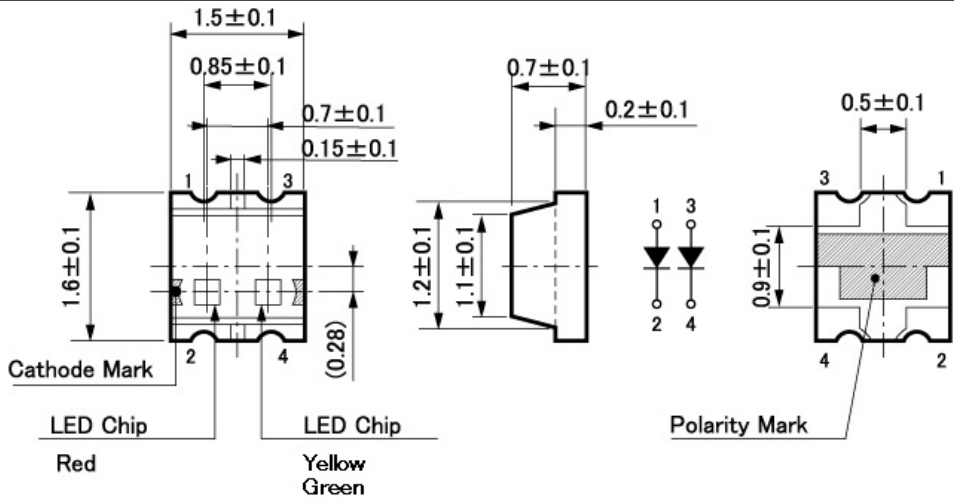

Recommended Soldering Pattern

(Unit: mm)

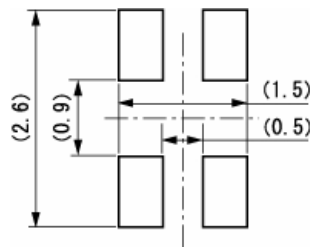

Taping Specification

(Unit: mm)

Quantity : 4,000pcs/ reel (standard)

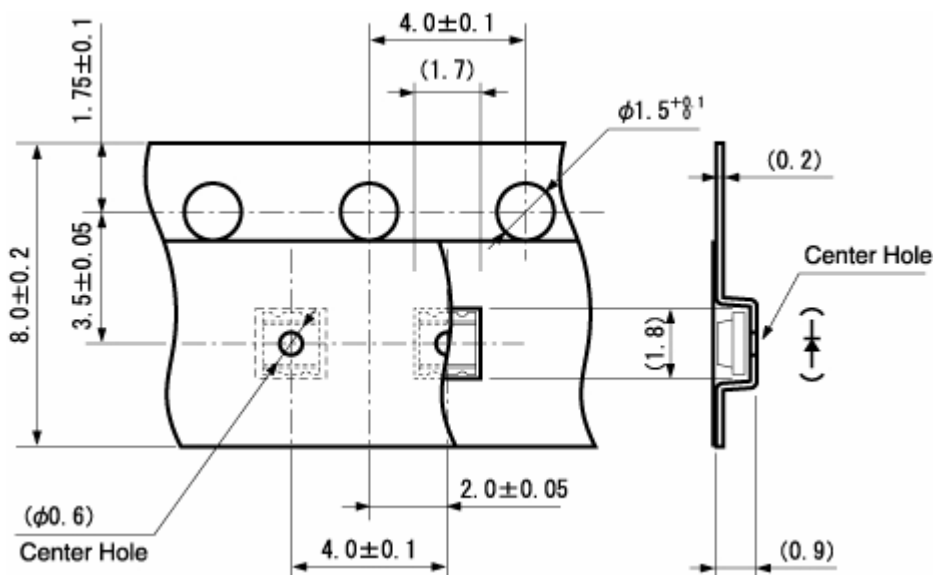

Package Dimensions(BRBG, BRPG, BRPY)

(Unit: mm)

Weight: (3.0)mg

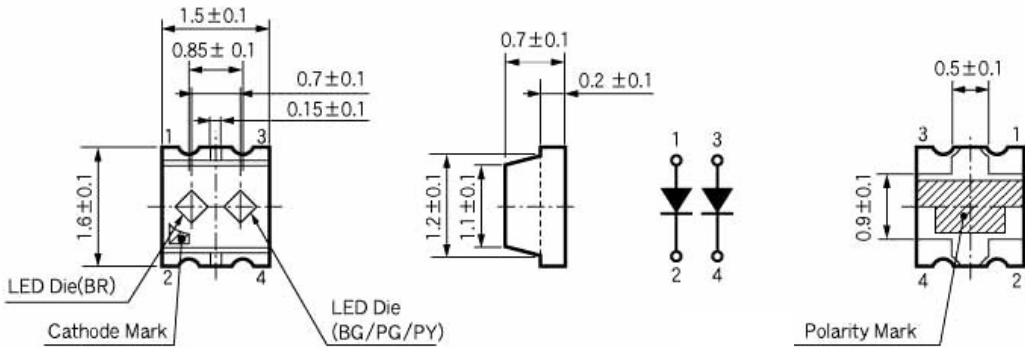

Recommended Soldering Pattern

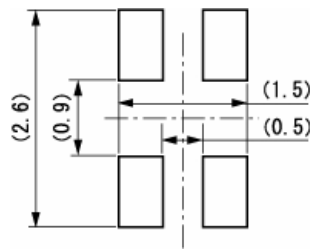
(Unit: mm)

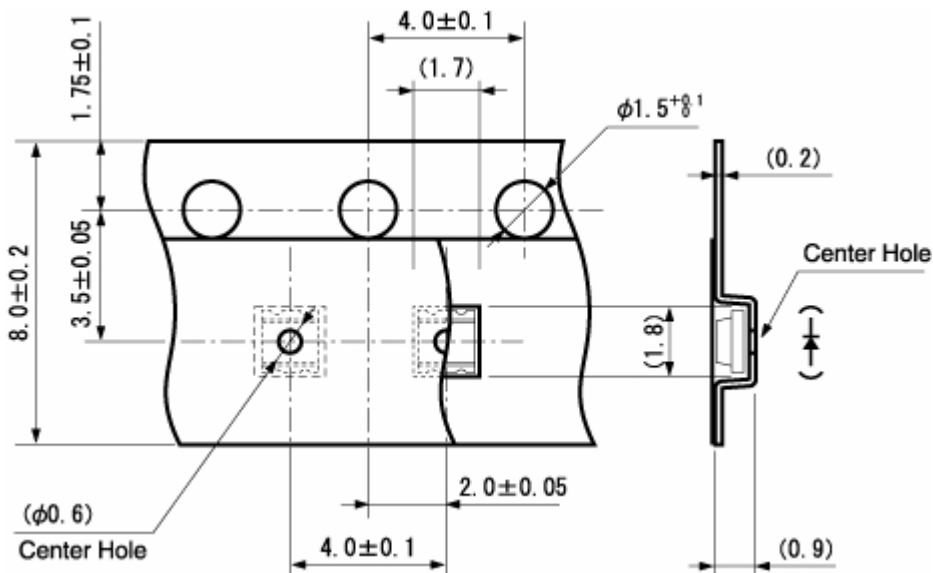

Taping Specification

(Unit: mm)

Quantity : 4,000pcs/ reel (standard)

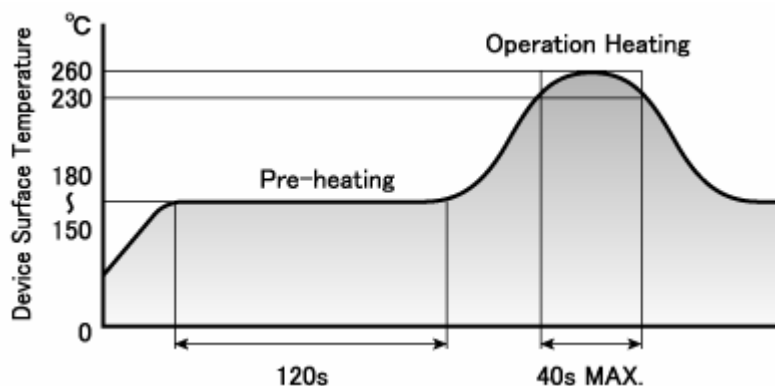

Reflow Soldering Conditions



- 1) The above profile temperature gives the maximum temperature of the LED resin surface. Please set the temperature so as to avoid exceeding this range.
- 2) Total times of reflow soldering process shall be no more than 2 times. When the second reflow soldering process is performed, intervals between the first and second reflow should be short as possible (while allowing some time for the component to return to normal temperature after the first reflow) in order to prevent the LED from absorbing moisture.
- 3) Temperature fluctuation to the LED during the pre-heating process shall be minimized.

Manual Soldering Conditions

Iron tip temp.	350 °C	(MAX.)
Soldering time and frequency	3 s	(MAX.)
	1 time	(MAX.)

Reliability Testing Result

Reliability Testing Result	Applicable Standard	Testing Conditions	Duration	Failure
Room Temp. Operating Life	EIAJ ED-4701/100(101)	Ta = 25°C, If = Maximum Rated Current	1,000 h	0/25
Resistance to Soldering Heat	EIAJ ED-4701/300(301)	Pre-heating : 150~180°C 120s Max. Operation Heating : 230°C 40s Max. Peak Temperature : 260°C	Twice	0/25
Temperature Cycling	EIAJ ED-4701/100(105)	Minimum Rated Storage Temperature(30min) ~Normal Temperature(15min) ~Maximum Rated Storage Temperature(30min) ~Normal Temperature(15min)	5 cycles	0/25
Wet High Temp. Storage Life	EIAJ ED-4701/100(103)	Ta = 60±2°C, RH = 90±5%	1,000 h	0/25
High Temp. Storage Life	EIAJ ED-4701/200(201)	Ta = Maximum Rated Storage Temperature	1,000 h	0/25
Low Temp. Storage Life	EIAJ ED-4701/200(202)	Ta = Minimum Rated Storage Temperature	1,000 h	0/25
Vibration, Variable Frequency	EIAJ ED-4701/400(403)	98.1m/s ² (10G), 100 ~ 2KHz sweep for 20min., XYZ each direction	2 h	0/10

Failure Criteria

Items	Symbols	Conditions	Failure criteria
Luminous Intensity	Iv	If Value of each product Luminous Intensity	Testing Min. Value < Spec. Min. Value x 0.5
Forward Voltage	V _F	If Value of each product Forward Voltage	Testing Max. Value ≥ Spec. Max. Value x 1.2
Reverse Current	I _R	V _R = Maximum Rated Reverse Voltage V	Testing Max. Value ≥ Spec. Max. Value x 2.5
Cosmetic Appearance	-	-	Occurrence of notable decoloration, deformation and cracking

Special Notice to Customers Using the Products and Technical Information Shown in This Data Sheet

- 1) The technical information shown in the data sheets are limited to the typical characteristics and circuit examples of the referenced products. It does not constitute the warranting of industrial property nor the granting of any license.
- 2) For the purpose of product improvement, the specifications, characteristics and technical data described in the data sheets are subject to change without prior notice. Therefore it is recommended that the most updated specifications be used in your design.
- 3) When using the products described in the data sheets, please adhere to the maximum ratings for operating voltage, heat dissipation characteristics, and other precautions for use. We are not responsible for any damage which may occur if these specifications are exceeded.
- 4) The products that have been described to this catalog are manufactured so that they will be used for the electrical instrument of the benchmark (OA equipment, telecommunications equipment, AV machine, home appliance and measuring instrument).
The application of aircrafts, space borne application, transportation equipment, medical equipment and nuclear power control equipment, etc. needs a high reliability and safety, and the breakdown and the wrong operation might influence the life or the human body. Please consult us beforehand if you plan to use our product for the usages of aircrafts, space borne application, transportation equipment, medical equipment and nuclear power control equipment, etc. except OA equipment, telecommunications equipment, AV machine, home appliance and measuring instrument.
- 5) In order to export the products or technologies described in this data sheet which are under the "Foreign Exchange and Foreign Trade Control Law," it is necessary to first obtain an export permit from the Japanese government.
- 6) No part of this data sheet may be reprinted or reproduced without prior written permission from Stanley Electric Co., Ltd.
- 7) The most updated edition of this data sheet can be obtained from the address below:
<http://www.stanley-components.com>