



Chipsmall Limited consists of a professional team with an average of over 10 year of expertise in the distribution of electronic components. Based in Hongkong, we have already established firm and mutual-benefit business relationships with customers from,Europe,America and south Asia,supplying obsolete and hard-to-find components to meet their specific needs.

With the principle of “Quality Parts,Customers Priority,Honest Operation,and Considerate Service”,our business mainly focus on the distribution of electronic components. Line cards we deal with include Microchip,ALPS,ROHM,Xilinx,Pulse,ON,Everlight and Freescale. Main products comprise IC,Modules,Potentiometer,IC Socket,Relay,Connector.Our parts cover such applications as commercial,industrial, and automotives areas.

We are looking forward to setting up business relationship with you and hope to provide you with the best service and solution. Let us make a better world for our industry!



Contact us

Tel: +86-755-8981 8866 Fax: +86-755-8427 6832

Email & Skype: info@chipsmall.com Web: www.chipsmall.com

Address: A1208, Overseas Decoration Building, #122 Zhenhua RD., Futian, Shenzhen, China



Power Block
Features

- Dual asymmetric N-channel OptiMOS™5 MOSFET
- Logic level (4.5V rated)
- Optimized for high performance buck converters
- Pb-free lead plating; RoHS compliant
- Qualified according to JEDEC¹⁾ for target applications
- Halogen-free according to IEC61249-2-21
- Monolithic integrated Schottky like diode

Product Summary

| | | Q1 | Q2 | |
|------------------|-----------------------|----|-----|----|
| V_{DS} | | 25 | 25 | V |
| $R_{DS(on),max}$ | $V_{GS}=10\text{ V}$ | 3 | 1.2 | mΩ |
| | $V_{GS}=4.5\text{ V}$ | 4 | 1.7 | |
| I_D | | 50 | 50 | A |

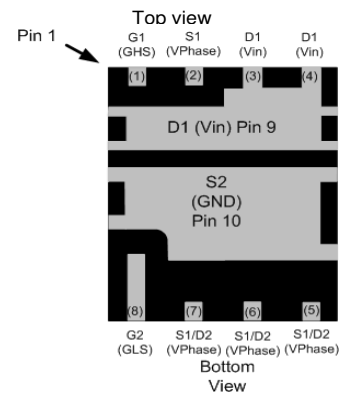
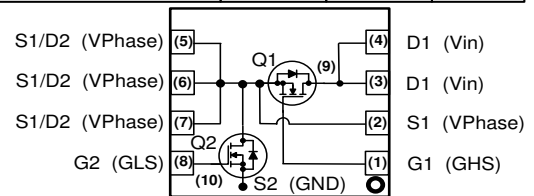

| Type | Package | Marking |
|------------|-------------|---------|
| BSG0813NDI | PG-TISON8-4 | 0813NDI |

Maximum ratings, at $T_j=25^\circ\text{C}$, unless otherwise specified ²⁾

| Parameter | Symbol | Conditions | Value | | Unit |
|-------------------------------------|----------------|---|-------------|------|------------------|
| | | | Q1 | Q2 | |
| Continuous drain current | I_D | $T_C=70^\circ\text{C}$, $V_{GS}=10\text{ V}$ | 50 | 50 | A |
| | | $T_C=70^\circ\text{C}$, $V_{GS}=4.5\text{ V}$ | 50 | 50 | |
| | | $T_A=25^\circ\text{C}$, $V_{GS}=4.5\text{ V}^{3)}$ | 31 | 50 | |
| | | $T_A=25^\circ\text{C}$, $V_{GS}=4.5\text{ V}^{4)}$ | 19 | 33 | |
| Pulsed drain current | $I_{D,pulse}$ | $T_C=70^\circ\text{C}$ | 160 | 160 | |
| Avalanche energy, single pulse | E_{AS} | Q1: $I_D=10\text{ A}$, Q2: $I_D=20\text{ A}$, $R_{GS}=25\ \Omega$ | 30 | 90 | mJ |
| Gate source voltage | V_{GS} | $T_j=25^\circ\text{C}$ | ± 16 | | V |
| Power dissipation | P_{tot} | $T_A=25^\circ\text{C}^{3)}$ | 6.25 | 6.25 | W |
| | | $T_A=25^\circ\text{C}^{4)}$ | 2.5 | 2.5 | |
| Operating and storage temperature | T_j, T_{stg} | | -55 ... 150 | | $^\circ\text{C}$ |
| IEC climatic category; DIN IEC 68-1 | | | 55/150/56 | | |

¹⁾ J-STD20 and JESD22

| Parameter | Symbol | Conditions | Values | | | Unit |
|-----------|--------|------------|--------|------|------|------|
| | | | min. | typ. | max. | |

Thermal characteristics

| | | | | | | | |
|--|----|--|--|---|----|-----|-----|
| Thermal resistance, junction - case | Q1 | R_{thJC} | | - | - | 4.3 | K/W |
| | Q2 | | | - | - | 2.2 | |
| Thermal resistance, junction - ambient ²⁾ | Q1 | R_{thJA} | Application specific board ³⁾ | - | - | 20 | |
| | Q2 | | | | | | |
| | Q1 | 6 cm ² cooling area ⁴⁾ | - | - | 50 | | |
| | Q2 | | | | | | |

Electrical characteristics, at $T_j=25\text{ °C}$, unless otherwise specified

Static characteristics

| | | | | | | | |
|---|----|---------------------|--|------------------|-----|-----|---------------|
| Drain-source breakdown voltage | Q1 | $V_{(BR)DSS}$ | $V_{GS}=0\text{ V}, I_D=1\text{ mA}$ | 25 ⁶⁾ | - | - | V |
| | Q2 | | | | | | |
| Breakdown voltage temperature coefficient | Q1 | $dV_{(BR)DSS}/dT_j$ | $I_D=10\text{ mA}$, referenced to 25 °C | - | 15 | - | mV/K |
| | Q2 | | | | | | |
| Gate threshold voltage | Q1 | $V_{GS(th)}$ | $V_{DS}=V_{GS}, I_D=250\text{ }\mu\text{A}$ | 1.2 | 1.6 | 2 | V |
| | Q2 | | | | | | |
| Zero gate voltage drain current | Q1 | I_{DSS} | $V_{DS}=25\text{ V}, V_{GS}=0\text{ V}, T_j=25\text{ °C}$ | - | - | 1 | μA |
| | Q2 | | | | | 500 | |
| | Q1 | | $V_{DS}=20\text{ V}, V_{GS}=0\text{ V}, T_j=125\text{ °C}$ | - | - | 100 | mA |
| | Q2 | | | | | 1 | |
| Gate-source leakage current | Q1 | I_{GSS} | $V_{GS}=16\text{ V}, V_{DS}=0\text{ V}$ | - | - | 100 | nA |
| | Q2 | | | | | | |
| Drain-source on-state resistance | Q1 | $R_{DS(on)}$ | $V_{GS}=4.5\text{ V}, I_D=20\text{ A}$ | - | 3.2 | 4.0 | m Ω |
| | Q2 | | | | | 1.7 | |
| | Q1 | | $V_{GS}=10\text{ V}, I_D=20\text{ A}$ | - | 2.4 | 3.0 | |
| | Q2 | | | | | 1.2 | |
| Gate resistance | Q1 | R_G | | - | 0.7 | 1.2 | Ω |
| | Q2 | | | | | 1.7 | |
| Transconductance | Q1 | g_{fs} | $ V_{DS} >2 I_D R_{DS(on)max}, I_D=20\text{ A}$ | 46 | 93 | - | S |
| | Q2 | | | | | 70 | |

²⁾ Only one of both transistors active

| Parameter | Symbol | Conditions | Values | | | Unit |
|-----------|--------|------------|--------|------|------|------|
| | | | min. | typ. | max. | |

Dynamic characteristics

| | | | | | | | |
|------------------------------|----|--------------|--|---|------|------|----|
| Input capacitance | Q1 | C_{iss} | $V_{GS}=0\text{ V},$ $V_{DS}=12\text{ V}, f=1\text{ MHz}$ | - | 780 | 1100 | pF |
| | Q2 | | | - | 2200 | 2900 | |
| Output capacitance | Q1 | C_{oss} | | - | 390 | 520 | |
| | Q2 | | | - | 1300 | 1700 | |
| Reverse transfer capacitance | Q1 | C_{rss} | | - | 38 | - | |
| | Q2 | | | - | 71 | - | |
| Turn-on delay time | Q1 | $t_{d(on)}$ | $V_{IN}=12\text{ V},$ $V_{DRV}=5\text{ V},$ $F_{SW}=500\text{ KHz},$ $I_{OUT}=20\text{ A}^{5)}$ | - | 4.3 | - | ns |
| | Q2 | | | - | 3.6 | - | |
| Rise time | Q1 | t_r | | - | 4.7 | - | |
| | Q2 | | | - | 2.8 | - | |
| Turn-off delay time | Q1 | $t_{d(off)}$ | | - | 4.3 | - | |
| | Q2 | | | - | 5.7 | - | |
| Fall time | Q1 | t_f | | - | 1.4 | - | |
| | Q2 | | | - | 1.7 | - | |

Gate Charge Characteristics

| | | | | | | | | |
|-----------------------|----|---------------|--|--|-----|-----|----|----|
| Gate to source charge | Q1 | Q_{gs} | $V_{DD}=12\text{ V},$ $I_D=20\text{ A},$ $V_{GS}=0\text{ to }4.5\text{ V}$ | - | 2.0 | | nC | |
| Gate to drain charge | | Q_{gd} | | - | 1.4 | - | | |
| Gate charge total | | Q_g | | - | 5.6 | 8.4 | | |
| Gate plateau voltage | | $V_{plateau}$ | | - | 2.6 | - | | V |
| Gate to source charge | Q2 | Q_{gs} | | $V_{DD}=12\text{ V},$ $I_D=20\text{ A},$ $V_{GS}=0\text{ to }4.5\text{ V}$ | - | 5.2 | - | nC |
| Gate to drain charge | | Q_{gd} | | | - | 3.1 | - | |
| Gate charge total | | Q_g | | | - | 15 | 22 | |
| Gate plateau voltage | | $V_{plateau}$ | | | - | 2.3 | - | |
| Output charge | Q1 | Q_{oss} | $V_{DD}=12\text{ V}, V_{GS}=0\text{ V}$ | | - | 8 | - | nC |
| | Q2 | | | | - | 27 | - | |

³⁾ 8 Layers copper 70µm thickness. PCB in still air

⁴⁾ Device on 40 mm x 40 mm x 1.5 mm epoxy PCB FR4 with 6 cm² (one layer, 70 µm thick) copper area for drain connection. PCB is vertical in still air.

| Parameter | Symbol | Conditions | Values | | | Unit | | |
|----------------------------------|--------|---------------|---|---|------|------|-----|---|
| | | | min. | typ. | max. | | | |
| Reverse Diode | | | | | | | | |
| Diode continuous forward current | Q1 | I_S | $T_C=25\text{ °C}$ | - | - | 29 | A | |
| | Q2 | | | - | - | 50 | | |
| Diode pulse current | Q1 | $I_{S,pulse}$ | | - | - | 160 | | |
| | Q2 | | | - | - | 160 | | |
| Diode forward voltage | Q1 | V_{SD} | | $V_{GS}=0\text{ V}, I_F=20\text{ A},$ $T_j=25\text{ °C}$ | - | 0.82 | 1 | V |
| | Q2 | | | $V_{GS}=0\text{ V}, I_F=11\text{ A},$ $T_j=25\text{ °C}$ | - | 0.52 | 0.7 | |
| Reverse recovery charge | Q1 | Q_{rr} | $V_R=12\text{ V}, I_F=I_S,$ $di_F/dt=100\text{ A}/\mu\text{s}$ | - | 10 | - | nC | |
| | Q2 | | | - | - | - | | |

⁵⁾ For more information see application note n° TBD

⁶⁾ The device can withstand a pulse of not more than 30 V for a duration of up to 2 ns at a frequency of 600 kHz with maximum buck converter input voltage $V_{IN}=16\text{ V}$

1 Power dissipation (Q1)

$$P_{tot}=f(T_A)^4$$

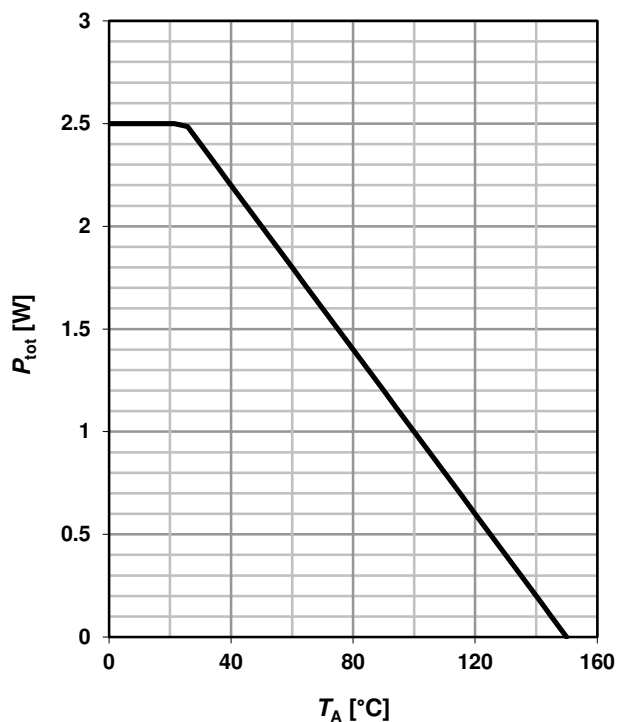

2 Power dissipation (Q2)

$$P_{tot}=f(T_A)^4$$

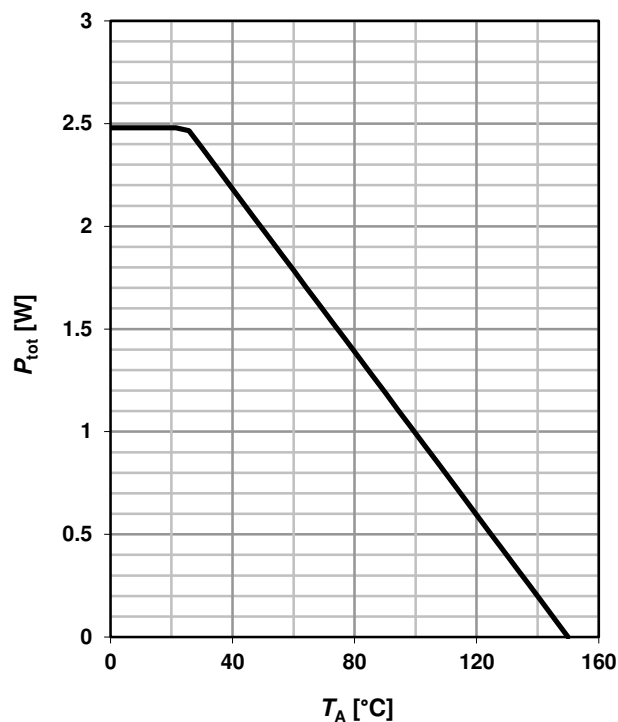

3 Drain current (Q1)

$$I_D=f(T_C)$$

parameter: $V_{GS} \geq 10$ V

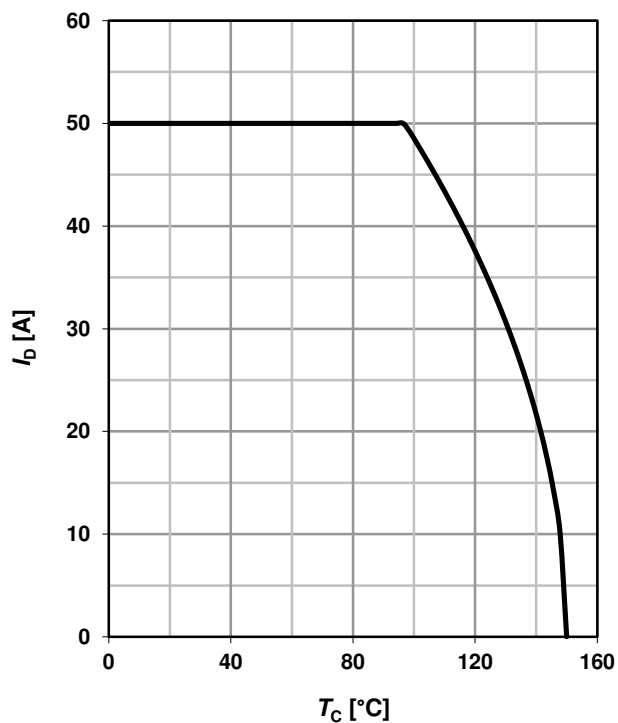

4 Drain current (Q2)

$$I_D=f(T_C)$$

parameter: $V_{GS} \geq 10$ V

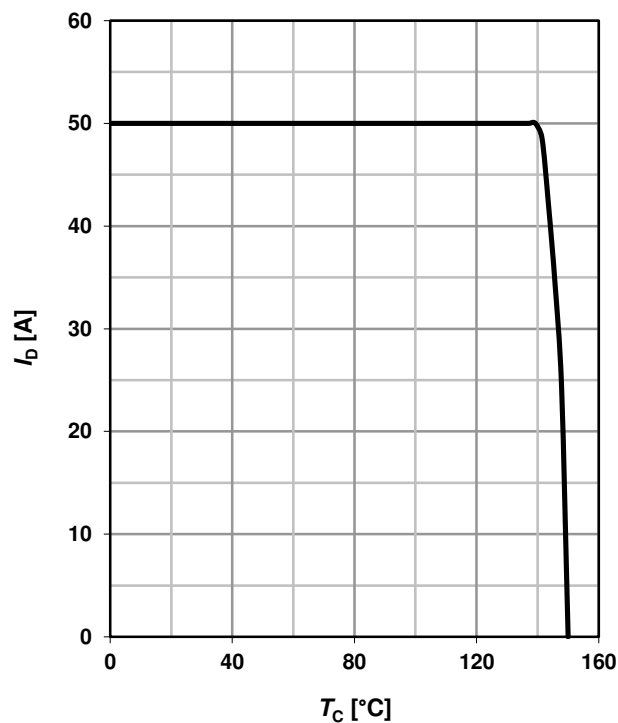

5 Safe operating area (Q1)

$I_D=f(V_{DS}); T_C=25\text{ }^\circ\text{C}; D=0$

parameter: t_p

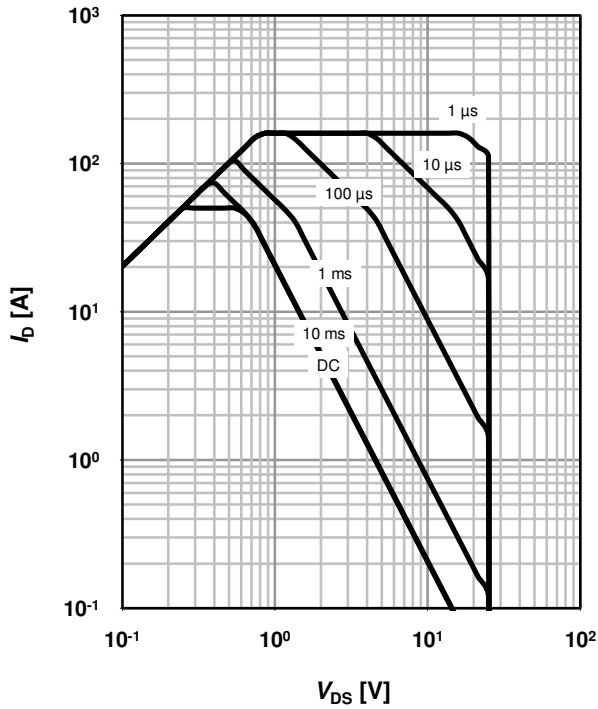

6 Safe operating area (Q2)

$I_D=f(V_{DS}); T_C=25\text{ }^\circ\text{C}; D=0$

parameter: t_p

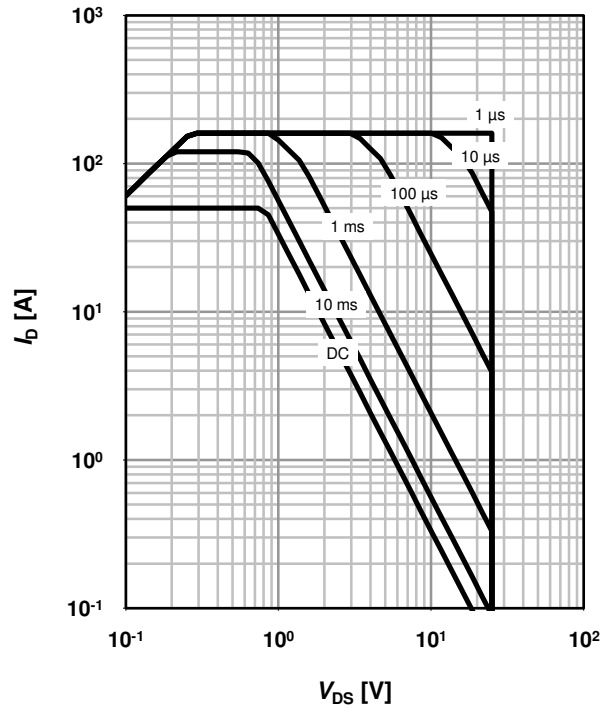

7 Max. transient thermal impedance (Q1)

$Z_{thJC}=f(t_p)$

parameter: $D=t_p/T$

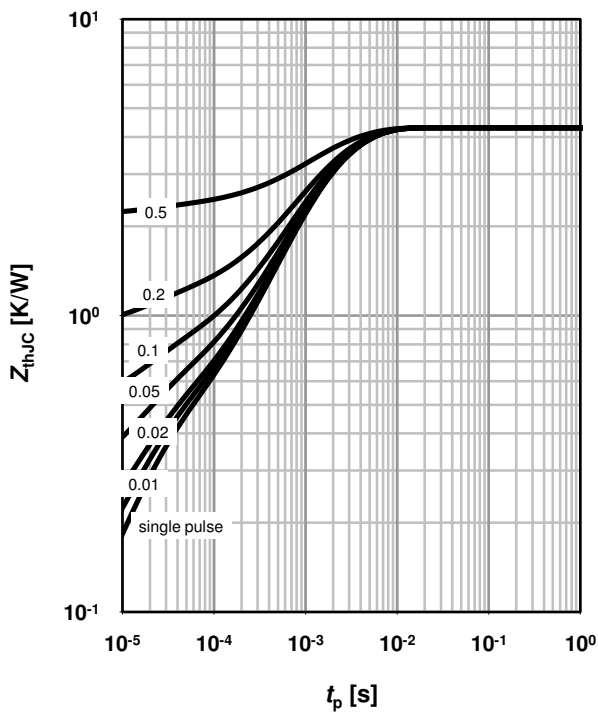

8 Max. transient thermal impedance (Q2)

$Z_{thJC}=f(t_p)$

parameter: $D=t_p/T$

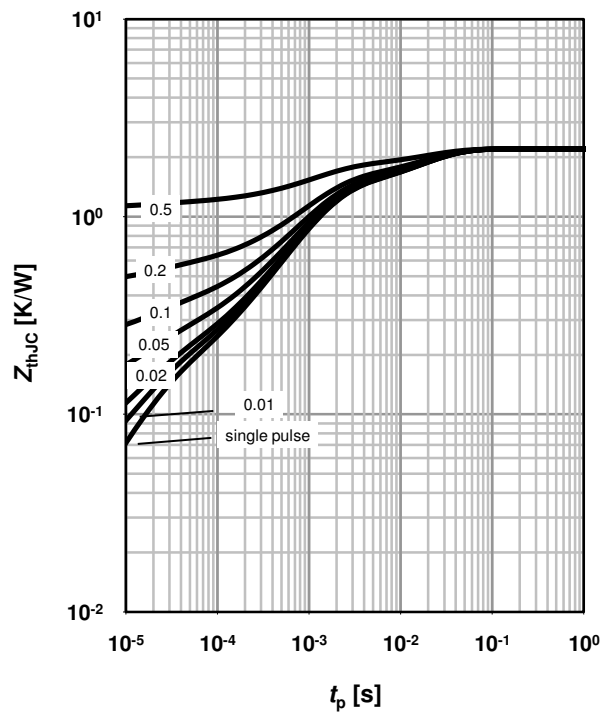

9 Typ. output characteristics (Q1)

$I_D=f(V_{DS}); T_j=25\text{ }^\circ\text{C}$

parameter: V_{GS}

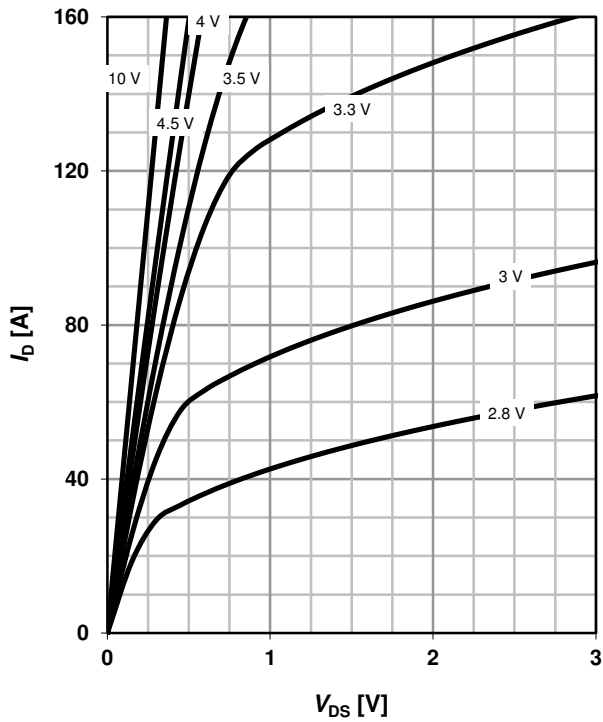

10 Typ. output characteristics (Q2)

$I_D=f(V_{DS}); T_j=25\text{ }^\circ\text{C}$

parameter: V_{GS}

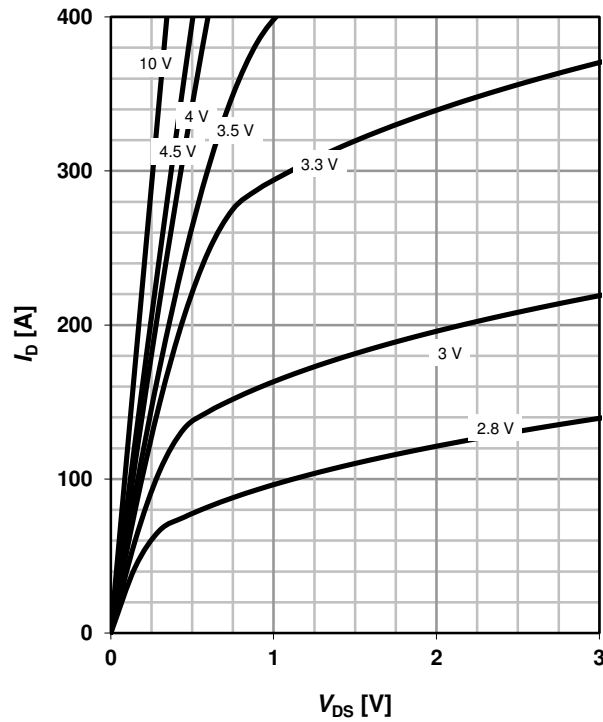

11 Typ. drain-source on resistance (Q1)

$R_{DS(on)}=f(I_D); T_j=25\text{ }^\circ\text{C}$

parameter: V_{GS}

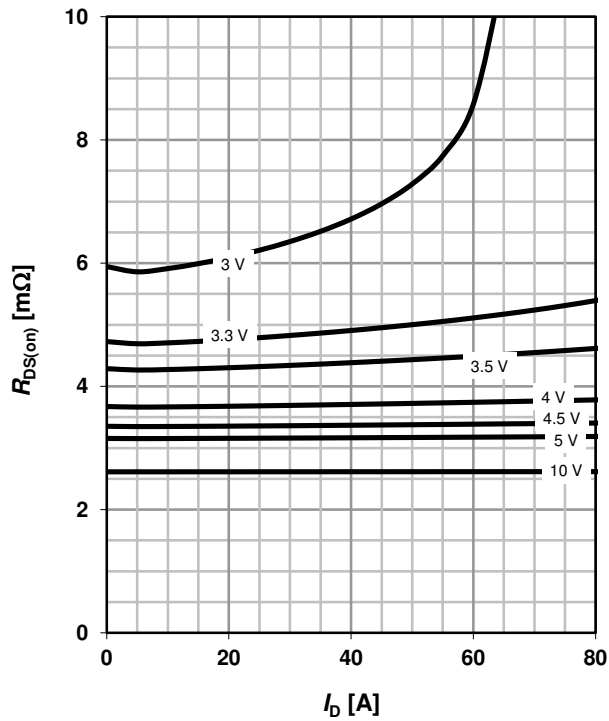

12 Typ. drain-source on resistance (Q2)

$R_{DS(on)}=f(I_D); T_j=25\text{ }^\circ\text{C}$

parameter: V_{GS}

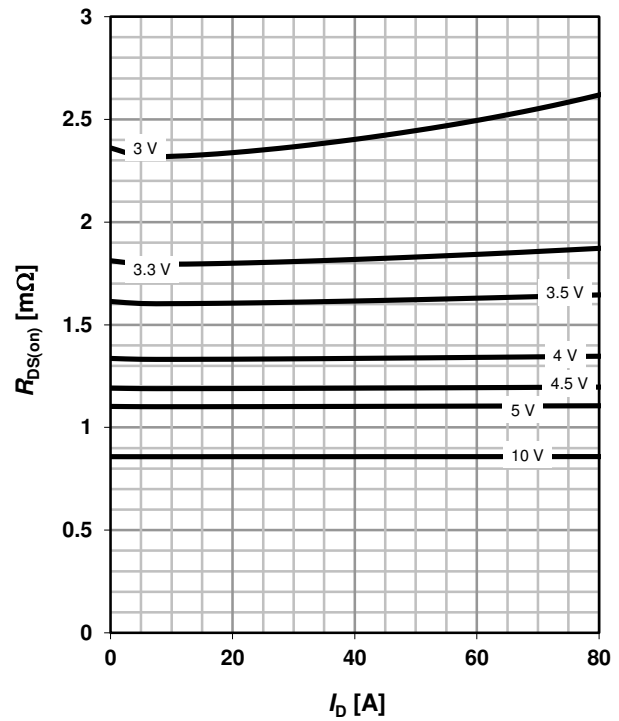

13 Typ. transfer characteristics (Q1)

$$I_D = f(V_{GS}); |V_{DS}| > 2 |I_D| R_{DS(on)max}$$

parameter: T_j

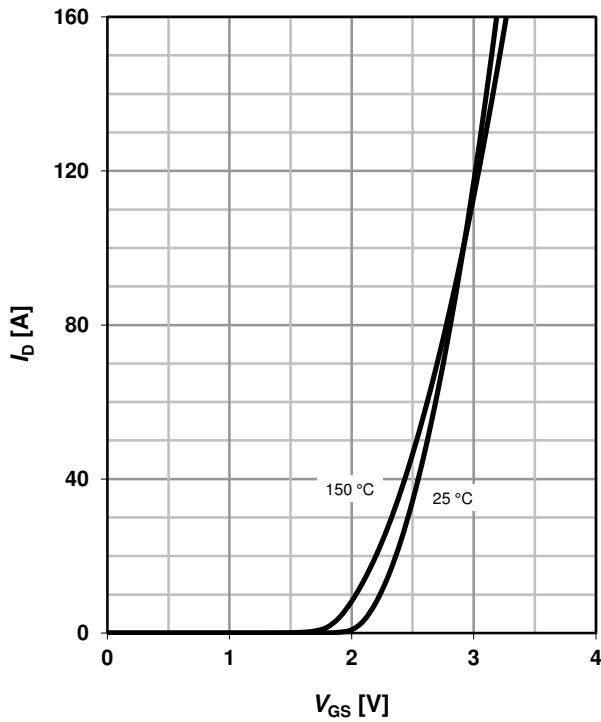

14 Typ. transfer characteristics (Q2)

$$I_D = f(V_{GS}); |V_{DS}| > 2 |I_D| R_{DS(on)max}$$

parameter: T_j

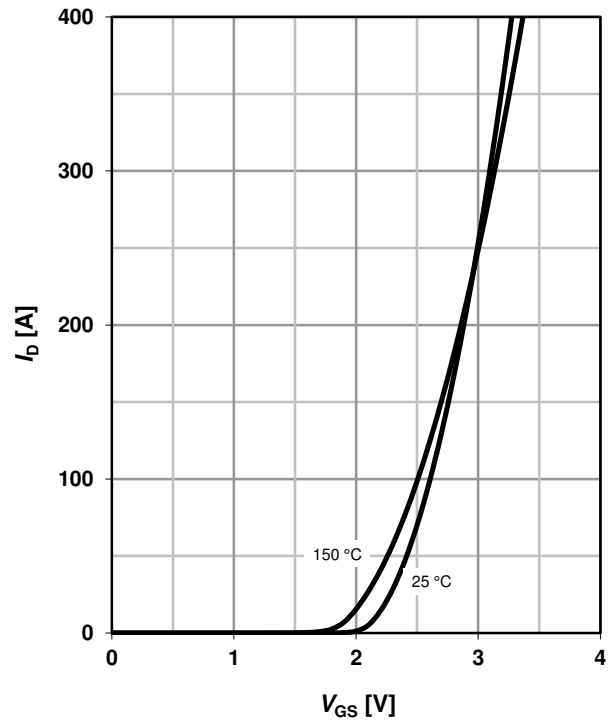

15 Drain-source on-state resistance (Q1)

$$R_{DS(on)} = f(T_j); I_D = 20 \text{ A}; V_{GS} = 10 \text{ V}$$

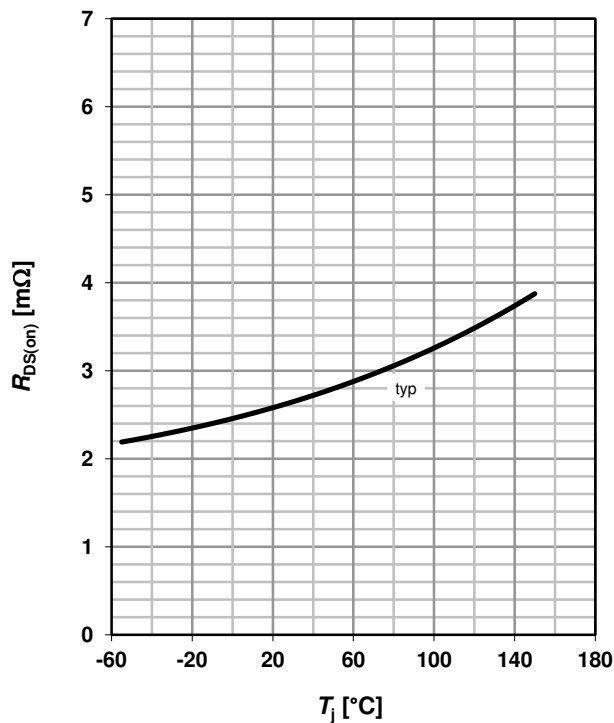

16 Drain-source on-state resistance (Q2)

$$R_{DS(on)} = f(T_j); I_D = 20 \text{ A}; V_{GS} = 10 \text{ V}$$

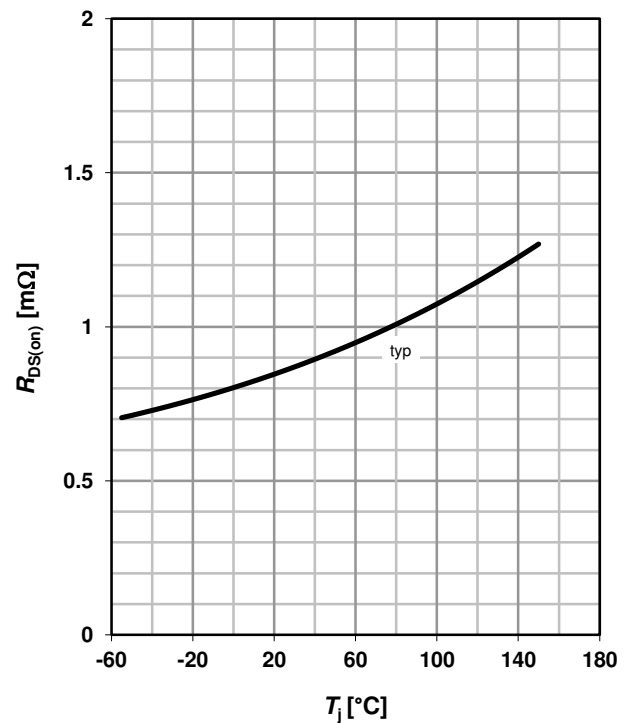

17 Typ. gate threshold voltage (Q1)

$V_{GS(th)}=f(T_j)$; $V_{GS}=V_{DS}$; $I_D=250 \mu A$

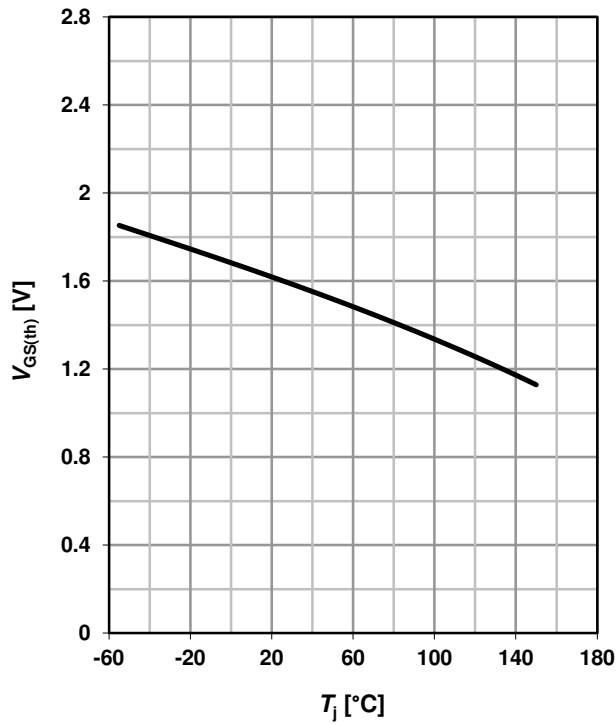

18 Typ. gate threshold voltage (Q2)

$V_{GS(th)}=f(T_j)$; $V_{GS}=V_{DS}$; $I_D=10 \text{ mA}$

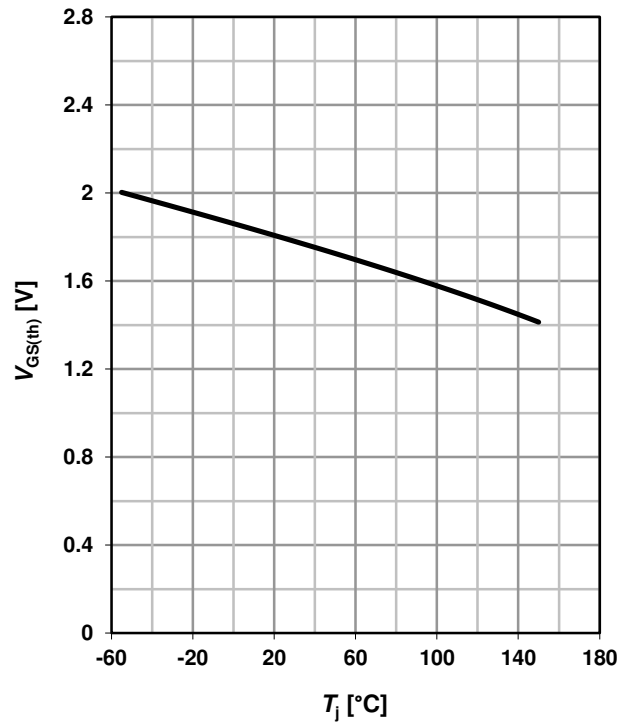

19 Typ. capacitances (Q1)

$C=f(V_{DS})$; $V_{GS}=0 \text{ V}$; $f=1 \text{ MHz}$

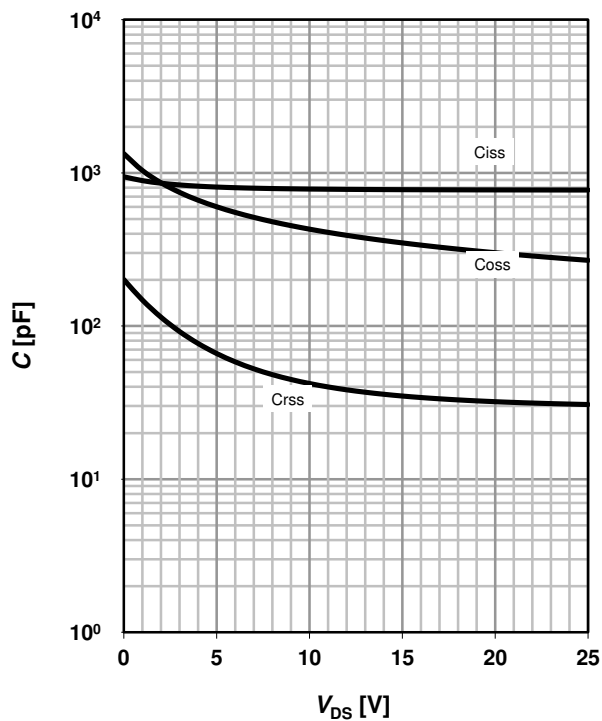

20 Typ. capacitances (Q2)

$C=f(V_{DS})$; $V_{GS}=0 \text{ V}$; $f=1 \text{ MHz}$

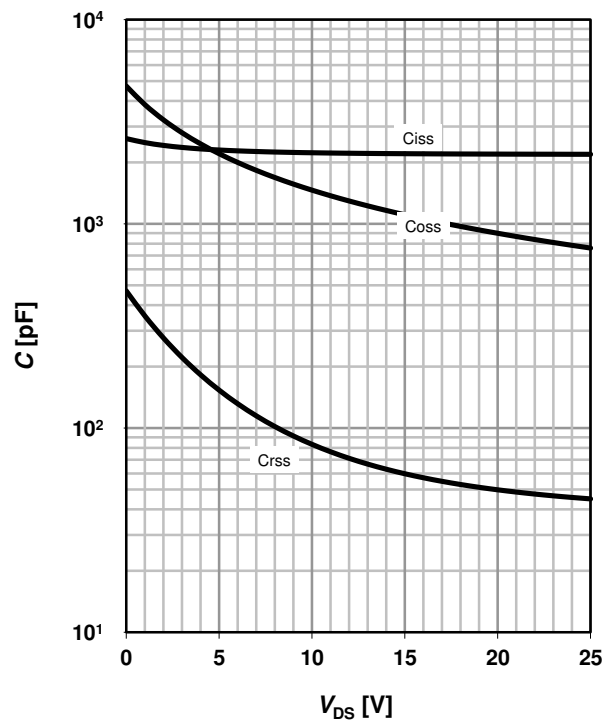

21 Forward characteristics of reverse diode (Q1)

$I_F=f(V_{SD})$

parameter: T_j

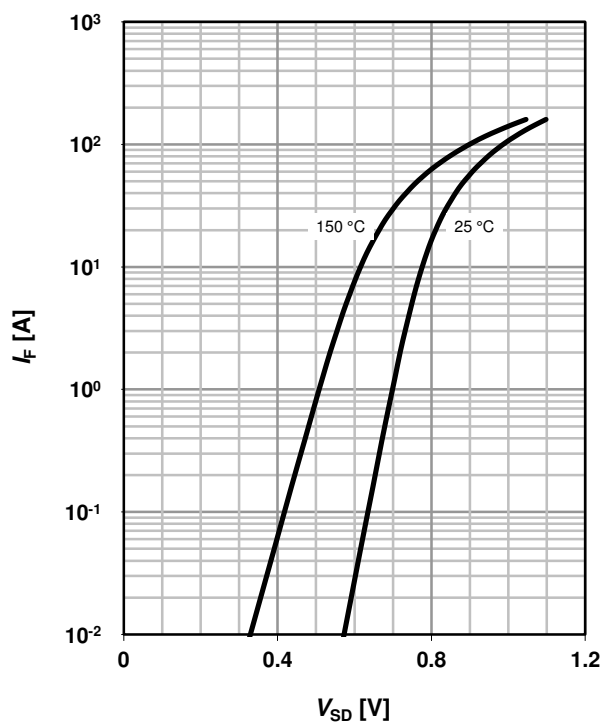

22 Forward characteristics of reverse diode (Q2)

$I_F=f(V_{SD})$

parameter: T_j

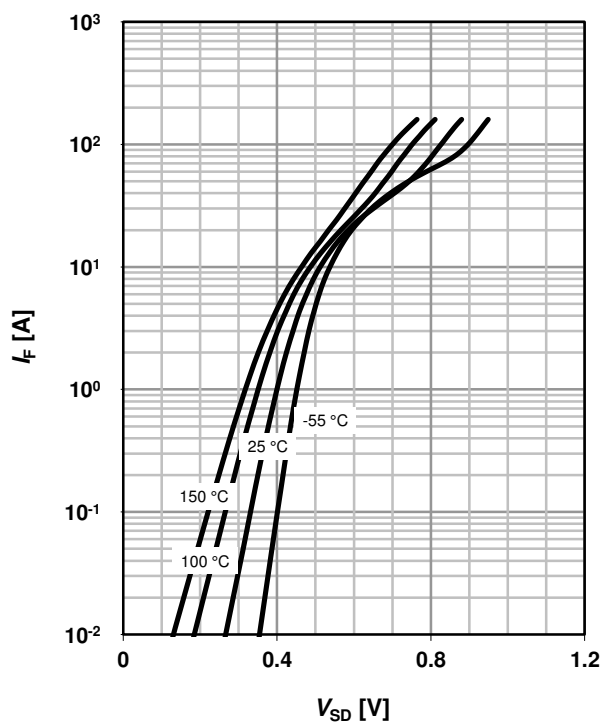

23 Avalanche characteristics (Q1)

$I_{AS}=f(t_{AV}); R_{GS}=25 \Omega$

parameter: $T_{j(start)}$

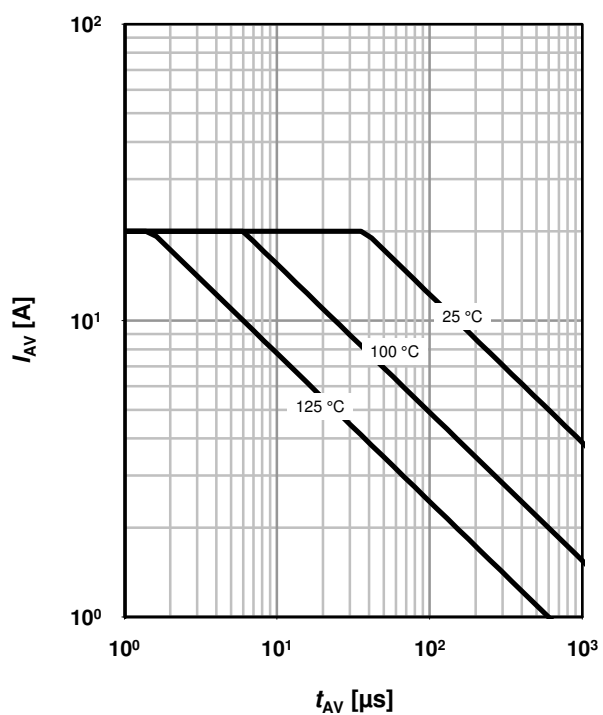

24 Avalanche characteristics (Q2)

$I_{AS}=f(t_{AV}); R_{GS}=25 \Omega$

parameter: $T_{j(start)}$

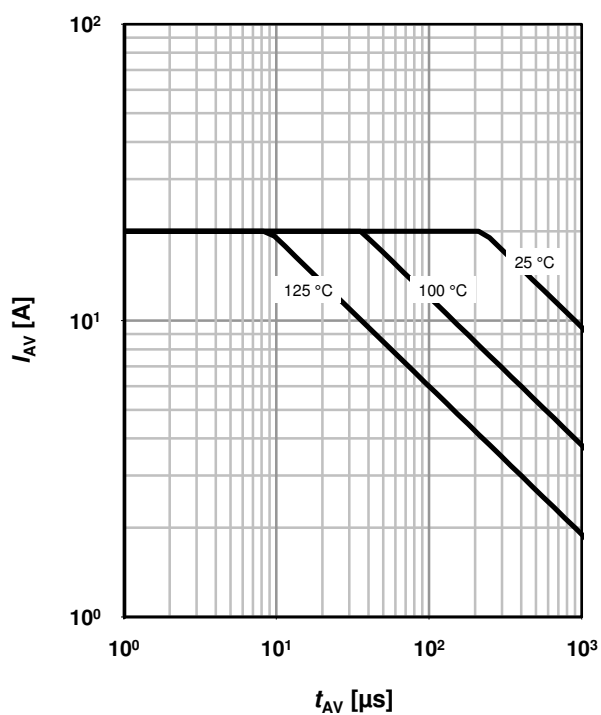

25 Typ. gate charge (Q1)

$V_{GS}=f(Q_{gate}); I_D=20\text{ A pulsed}$

parameter: V_{DD}

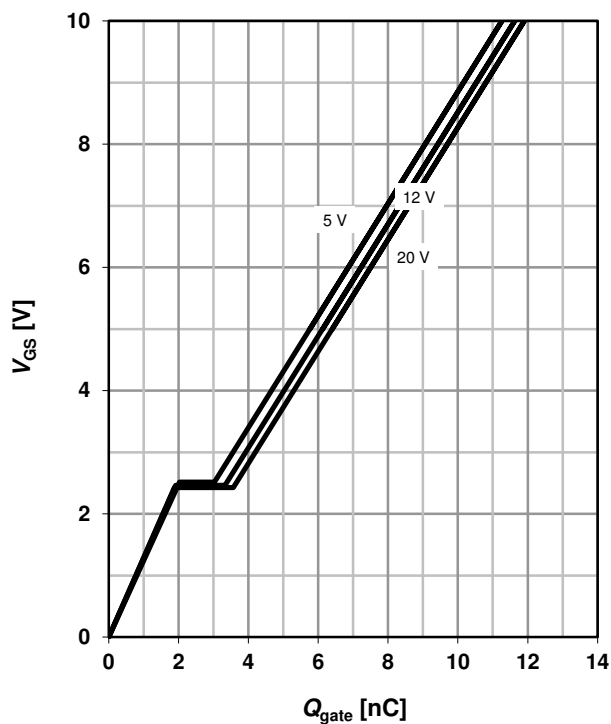

26 Typ. gate charge (Q2)

$V_{GS}=f(Q_{gate}); I_D=20\text{ A pulsed}$

parameter: V_{DD}

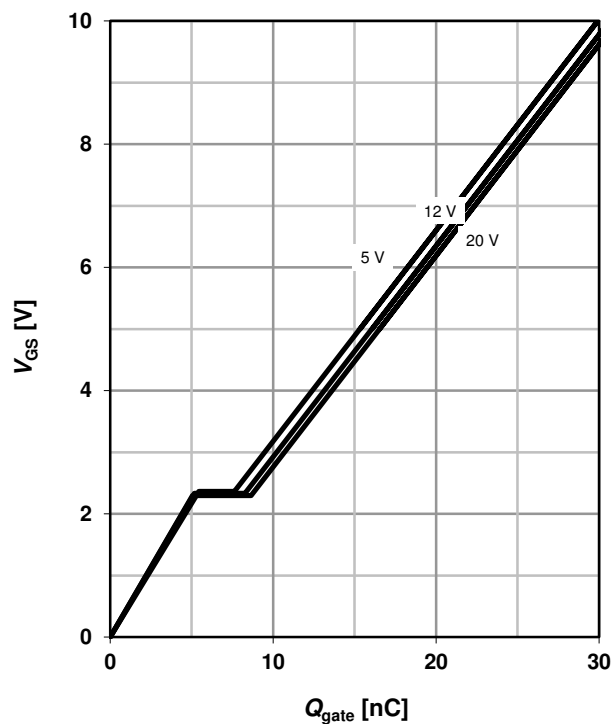

27 Drain-source breakdown voltage (Q1)

$V_{BR(DSS)}=f(T_j); I_D=1\text{ mA}$

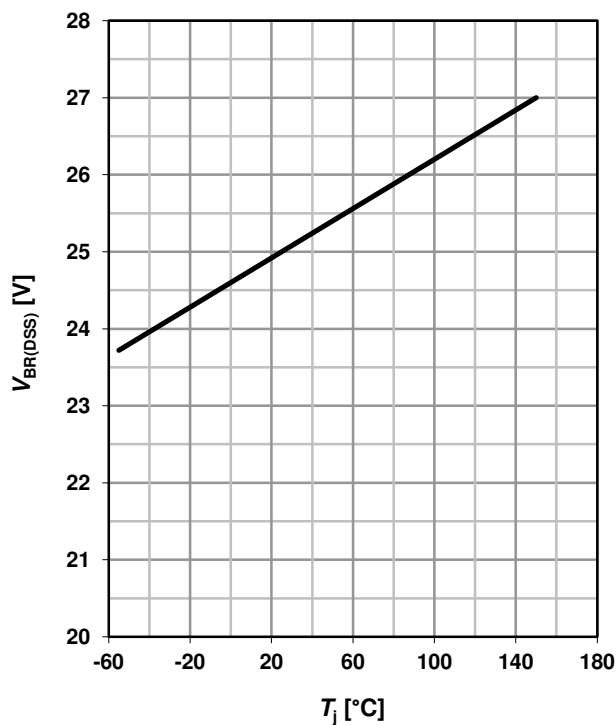

28 Typ. drain-source leakage current (Q2)

$I_{DSS}=f(V_{DS}); V_{GS}=0\text{ V}$

parameter: T_j

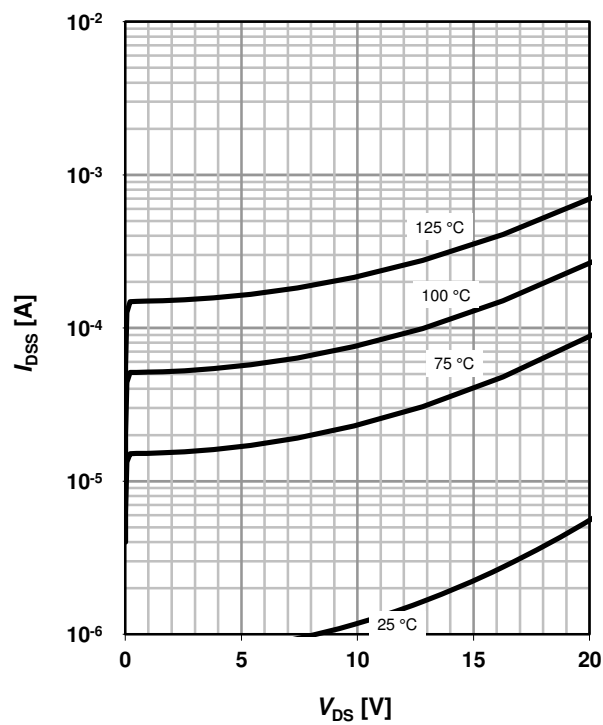

Package Outline

PG-TISON8-4

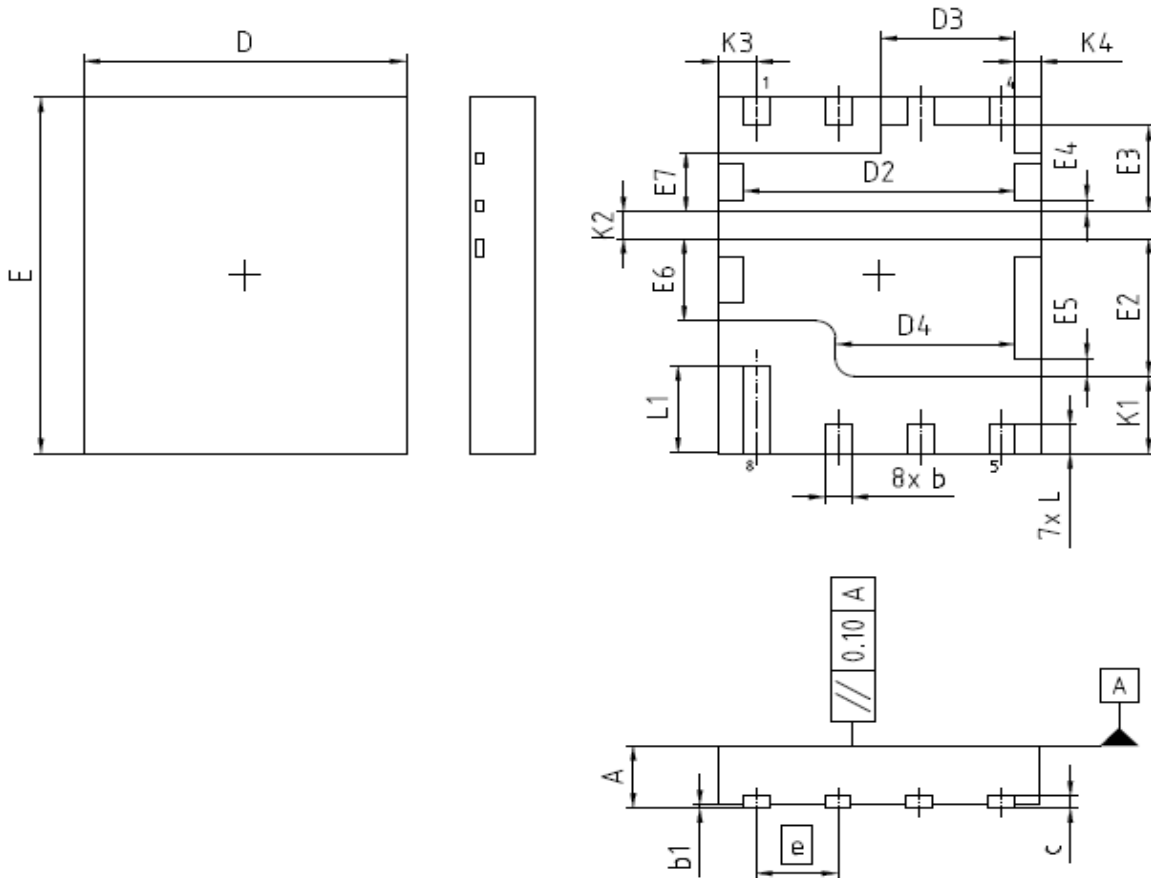

| DIM | MILLIMETERS | | INCHES | |
|-----|-------------|------|------------|-------|
| | MIN | MAX | MIN | MAX |
| A | 0.90 | 1.15 | 0.035 | 0.045 |
| b | 0.31 | 0.51 | 0.012 | 0.020 |
| b1 | 0.00 | 0.05 | 0.000 | 0.002 |
| c | 0.10 | 0.30 | 0.004 | 0.012 |
| D | 4.90 | 5.10 | 0.193 | 0.201 |
| D2 | 4.12 | 4.32 | 0.162 | 0.170 |
| D3 | 1.99 | 2.19 | 0.078 | 0.086 |
| D4 | 2.69 | 2.89 | 0.106 | 0.114 |
| E | 5.90 | 6.10 | 0.232 | 0.240 |
| E2 | 2.22 | 2.42 | 0.087 | 0.095 |
| E3 | 1.35 | 1.55 | 0.053 | 0.061 |
| E4 | 0.10 | 0.30 | 0.004 | 0.012 |
| E5 | 0.20 | 0.40 | 0.008 | 0.016 |
| E6 | 1.29 | 1.49 | 0.051 | 0.059 |
| E7 | 0.90 | 1.10 | 0.035 | 0.043 |
| e | 1.27 (BSC) | | 0.05 (BSC) | |
| N | 8 | | 8 | |
| L | 0.38 | 0.58 | 0.015 | 0.023 |
| L1 | 1.38 | 1.58 | 0.054 | 0.062 |
| K1 | 1.20 | 1.40 | 0.047 | 0.055 |
| K2 | 0.35 | 0.55 | 0.014 | 0.022 |
| K3 | 0.50 | 0.70 | 0.020 | 0.028 |
| K4 | 0.29 | 0.49 | 0.011 | 0.019 |

DOCUMENT NO.
Z8 B00176527

SCALE

EUROPEAN PROJECTION

ISSUE DATE
13-03-2015

REVISION
01

Boardpads & Apertures

PG-TISON8-4

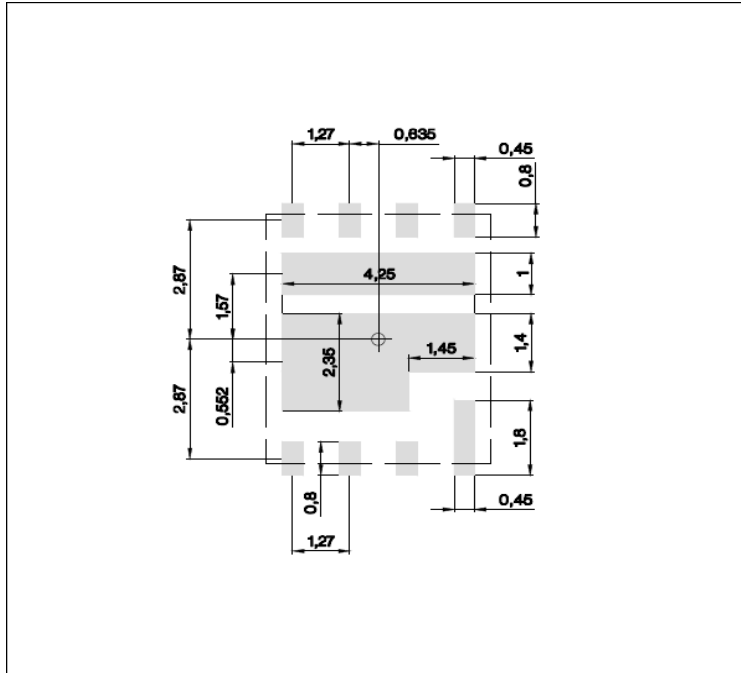

■ copper

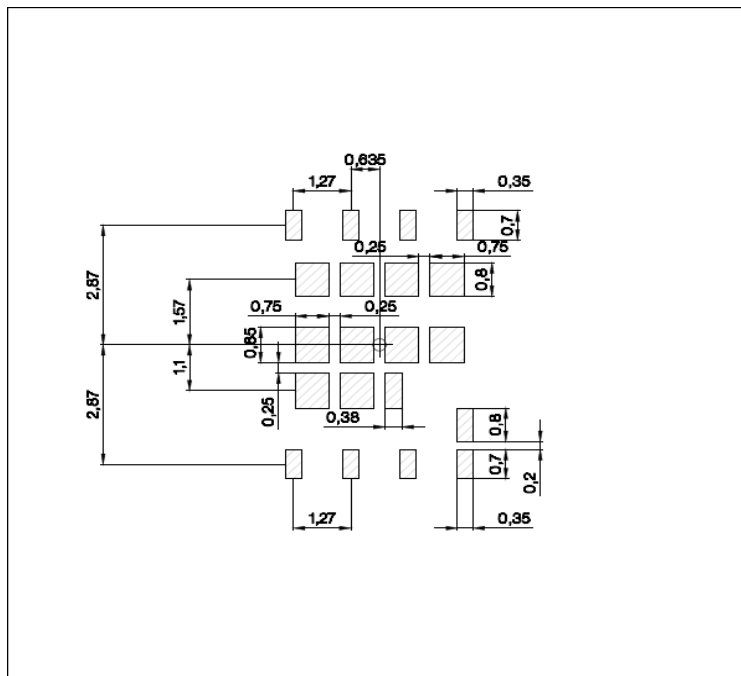

▨ stencil apertures

All the dimensions in mm

Revision History

BSG0813NDI

Revision: 2016-03-24, Rev. 2.1

Previous Revision

| Revision | Date | Subjects (major changes since last revision) |
|----------|------------|--|
| 2.0 | 2015-03-17 | Release of final version |
| 2.1 | 2016-03-24 | Update package drawing |

Trademarks of Infineon Technologies AG

AURIX™, C166™, CanPAK™, CIPOS™, CoolGaN™, CoolMOS™, CoolSET™, CoolSiC™, CORECONTROL™, CROSSAVE™, DAVE™, DI-POL™, DrBlade™, EasyPIM™, EconoBRIDGE™, EconoDUAL™, EconoPACK™, EconoPIM™, EiceDRIVER™, eupec™, FCOS™, HITFET™, HybridPACK™, Infineon™, ISOFACE™, IsoPACK™, i-Wafer™, MIPAQ™, ModSTACK™, my-d™, NovalithIC™, OmniTune™, OPTIGA™, OptiMOS™, ORIGA™, POWERCODE™, PRIMARION™, PrimePACK™, PrimeSTACK™, PROFET™, PRO-SIL™, RASIC™, REAL3™, ReverSave™, SatRIC™, SIEGET™, SiPMOS™, SmartLEWIS™, SOLID FLASH™, SPOC™, TEMPFET™, thinQ!™, TRENCHSTOP™, TriCore™.

Trademarks updated August 2015

Other Trademarks

All referenced product or service names and trademarks are the property of their respective owners.

We Listen to Your Comments

Any information within this document that you feel is wrong, unclear or missing at all? Your feedback will help us to continuously improve the quality of this document. Please send your proposal (including a reference to this document) to:

erratum@infineon.com

Published by
Infineon Technologies AG
81726 München, Germany
© 2016 Infineon Technologies AG
All Rights Reserved.

Legal Disclaimer

The information given in this document shall in no event be regarded as a guarantee of conditions or characteristics. With respect to any examples or hints given herein, any typical values stated herein and/or any information regarding the application of the device, Infineon Technologies hereby disclaims any and all warranties and liabilities of any kind, including without limitation, warranties of non-infringement of intellectual property rights of any third party.

Information

For further information on technology, delivery terms and conditions and prices please contact your nearest Infineon Technologies Office (www.infineon.com).

Warnings

Due to technical requirements, components may contain dangerous substances. For information on the types in question, please contact the nearest Infineon Technologies Office.

The Infineon Technologies component described in this Data Sheet may be used in life-support devices or systems and/or automotive, aviation and aerospace applications or systems only with the express written approval of Infineon Technologies, if a failure of such components can reasonably be expected to cause the failure of that life-support, automotive, aviation and aerospace device or system or to affect the safety or effectiveness of that device or system. Life support devices or systems are intended to be implanted in the human body or to support and/or maintain and sustain and/or protect human life. If they fail, it is reasonable to assume that the health of the user or other persons may be endangered.