



Chipsmall Limited consists of a professional team with an average of over 10 year of expertise in the distribution of electronic components. Based in Hongkong, we have already established firm and mutual-benefit business relationships with customers from,Europe,America and south Asia,supplying obsolete and hard-to-find components to meet their specific needs.

With the principle of “Quality Parts,Customers Priority,Honest Operation,and Considerate Service”,our business mainly focus on the distribution of electronic components. Line cards we deal with include Microchip,ALPS,ROHM,Xilinx,Pulse,ON,Everlight and Freescale. Main products comprise IC,Modules,Potentiometer,IC Socket,Relay,Connector.Our parts cover such applications as commercial,industrial, and automotives areas.

We are looking forward to setting up business relationship with you and hope to provide you with the best service and solution. Let us make a better world for our industry!



## Contact us

Tel: +86-755-8981 8866 Fax: +86-755-8427 6832

Email & Skype: info@chipsmall.com Web: www.chipsmall.com

Address: A1208, Overseas Decoration Building, #122 Zhenhua RD., Futian, Shenzhen, China



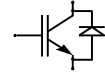

**Elektrische Eigenschaften / Electrical properties**

**Höchstzulässige Werte / Maximum rated values**

**Diode Gleichrichter/ Diode Rectifier**

Periodische Rückw. Spitzenspernung repetitive peak reverse voltage		$V_{RRM}$	1600	V
Durchlaßstrom Grenzeffektivwert RMS forward current per chip		$I_{FRMSM}$	40	A
Dauergleichstrom DC forward current	$T_C = 80^\circ C$	$I_d$	35	A
Stoßstrom Grenzwert surge forward current	$t_p = 10\text{ ms}, T_{vj} = 25^\circ C$ $t_p = 10\text{ ms}, T_{vj} = 150^\circ C$	$I_{FSM}$	315 260	A A
Grenzlastintegral $I^2t$ - value	$t_p = 10\text{ ms}, T_{vj} = 25^\circ C$ $t_p = 10\text{ ms}, T_{vj} = 150^\circ C$	$I^2t$	500 340	$A^2s$ $A^2s$

**Transistor Wechselrichter/ Transistor Inverter**

Kollektor-Emitter-Spernung collector-emitter voltage		$V_{CES}$	1200	V
Kollektor-Dauergleichstrom DC-collector current	$T_C = 80^\circ C$ $T_C = 25^\circ C$	$I_{C,nom.}$ $I_C$	35 45	A A
Periodischer Kollektor Spitzenstrom repetitive peak collector current	$t_p = 1\text{ ms}, T_C = 80^\circ C$	$I_{CRM}$	70	A
Gesamt-Verlustleistung total power dissipation	$T_C = 25^\circ C$	$P_{tot}$	230	W
Gate-Emitter-Spernung gate-emitter peak voltage		$V_{GES}$	+/- 20V	V

**Diode Wechselrichter/ Diode Inverter**

Dauergleichstrom DC forward current	$T_C = 80^\circ C$	$I_F$	35	A
Periodischer Spitzenstrom repetitive peak forw. current	$t_p = 1\text{ ms}$	$I_{FRM}$	70	A
Grenzlastintegral $I^2t$ - value	$V_R = 0V, t_p = 10\text{ms}, T_{vj} = 125^\circ C$	$I^2t$	310	$A^2s$

**Transistor Brems-Chopper/ Transistor Brake-Chopper**

Kollektor-Emitter-Spernung collector-emitter voltage		$V_{CES}$	1200	V
Kollektor-Dauergleichstrom DC-collector current	$T_C = 80^\circ C$ $T_C = 25^\circ C$	$I_{C,nom.}$ $I_C$	17,5 35	A A
Periodischer Kollektor Spitzenstrom repetitive peak collector current	$t_p = 1\text{ ms}, T_C = 80^\circ C$	$I_{CRM}$	35	A
Gesamt-Verlustleistung total power dissipation	$T_C = 25^\circ C$	$P_{tot}$	180	W
Gate-Emitter-Spernung gate-emitter peak voltage		$V_{GES}$	+/- 20V	V

**Diode Brems-Chopper/ Diode Brake-Chopper**

Dauergleichstrom DC forward current	$T_C = 80^\circ C$	$I_F$	10	A
Periodischer Spitzenstrom repetitive peak forw. current	$t_p = 1\text{ ms}$	$I_{FRM}$	20	A

prepared by: Andreas Schulz	date of publication:29.03.2001
approved by: Robert Severin	revision: 5

# Technische Information / Technical Information

IGBT-Module  
IGBT-Modules

## BSM35GP120

eupec

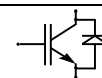

### Modul Isolation/ Module Isolation

Isolations-Prüfspannung insulation test voltage	RMS, f = 50 Hz, t = 1 min. NTC connected to Baseplate	$V_{ISOL}$	2,5	kV
--	--	------------	-----	----

### Elektrische Eigenschaften / Electrical properties

#### Charakteristische Werte / Characteristic values

##### Diode Gleichrichter/ Diode Rectifier

				min.	typ.	max.	
Durchlaßspannung forward voltage	$T_{vj} = 150^{\circ}\text{C}$ , $I_F = 35\text{ A}$	$V_F$	-	1,15	1,2	V	
Schleusenspannung threshold voltage	$T_{vj} = 150^{\circ}\text{C}$	$V_{(TO)}$	-	-	0,8	V	
Ersatzwiderstand slope resistance	$T_{vj} = 150^{\circ}\text{C}$	$r_T$	-	-	10,5	m $\Omega$	
Sperrstrom reverse current	$T_{vj} = 150^{\circ}\text{C}$ , $V_R = 1600\text{ V}$	$I_R$	-	2	-	mA	
Modul Leitungswiderstand, Anschlüsse-Chip lead resistance, terminals-chip	$T_C = 25^{\circ}\text{C}$	$R_{AA+CC}$	-	5	-	m $\Omega$	

##### Transistor Wechselrichter/ Transistor Inverter

				min.	typ.	max.	
Kollektor-Emitter Sättigungsspannung collector-emitter saturation voltage	$V_{GE} = 15\text{V}$ , $T_{vj} = 25^{\circ}\text{C}$ , $I_C = 35\text{ A}$	$V_{CE\text{ sat}}$	-	2,4	2,85	V	
	$V_{GE} = 15\text{V}$ , $T_{vj} = 125^{\circ}\text{C}$ , $I_C = 35\text{ A}$		-	2,9	-	V	
Gate-Schwellenspannung gate threshold voltage	$V_{CE} = V_{GE}$ , $T_{vj} = 25^{\circ}\text{C}$ , $I_C = 1\text{ mA}$	$V_{GE(TO)}$	4,5	5,5	6,5	V	
Eingangskapazität input capacitance	f = 1MHz, $T_{vj} = 25^{\circ}\text{C}$ $V_{CE} = 25\text{ V}$ , $V_{GE} = 0\text{ V}$	$C_{ies}$	-	1,5	-	nF	
Kollektor-Emitter Reststrom collector-emitter cut-off current	$V_{GE} = 0\text{V}$ , $T_{vj} = 25^{\circ}\text{C}$ , $V_{CE} = 1200\text{ V}$	$I_{CES}$	-	1,5	500	$\mu\text{A}$	
	$V_{GE} = 0\text{V}$ , $T_{vj} = 125^{\circ}\text{C}$ , $V_{CE} = 1200\text{ V}$		-	2,0	-	mA	
Gate-Emitter Reststrom gate-emitter leakage current	$V_{CE} = 0\text{V}$ , $V_{GE} = 20\text{V}$ , $T_{vj} = 25^{\circ}\text{C}$	$I_{GES}$	-	-	300	nA	
Einschaltverzögerungszeit (ind. Last) turn on delay time (inductive load)	$I_C = I_{Nenn}$ , $V_{CC} = 600\text{ V}$	$t_{d,on}$	-	50	-	ns	
	$V_{GE} = \pm 15\text{V}$ , $T_{vj} = 25^{\circ}\text{C}$ , $R_G = 22\text{ Ohm}$						
	$V_{GE} = \pm 15\text{V}$ , $T_{vj} = 125^{\circ}\text{C}$ , $R_G = 22\text{ Ohm}$						
Anstiegszeit (induktive Last) rise time (inductive load)	$I_C = I_{Nenn}$ , $V_{CC} = 600\text{ V}$	$t_r$	-	55	-	ns	
	$V_{GE} = \pm 15\text{V}$ , $T_{vj} = 25^{\circ}\text{C}$ , $R_G = 22\text{ Ohm}$						
	$V_{GE} = \pm 15\text{V}$ , $T_{vj} = 125^{\circ}\text{C}$ , $R_G = 22\text{ Ohm}$						
Abschaltverzögerungszeit (ind. Last) turn off delay time (inductive load)	$I_C = I_{Nenn}$ , $V_{CC} = 600\text{ V}$	$t_{d,off}$	-	290	-	ns	
	$V_{GE} = \pm 15\text{V}$ , $T_{vj} = 25^{\circ}\text{C}$ , $R_G = 22\text{ Ohm}$						
	$V_{GE} = \pm 15\text{V}$ , $T_{vj} = 125^{\circ}\text{C}$ , $R_G = 22\text{ Ohm}$						
Fallzeit (induktive Last) fall time (inductive load)	$I_C = I_{Nenn}$ , $V_{CC} = 600\text{ V}$	$t_f$	-	50	-	ns	
	$V_{GE} = \pm 15\text{V}$ , $T_{vj} = 25^{\circ}\text{C}$ , $R_G = 22\text{ Ohm}$						
	$V_{GE} = \pm 15\text{V}$ , $T_{vj} = 125^{\circ}\text{C}$ , $R_G = 22\text{ Ohm}$						
Einschaltverlustenergie pro Puls turn-on energy loss per pulse	$I_C = I_{Nenn}$ , $V_{CC} = 600\text{ V}$ $V_{GE} = \pm 15\text{V}$ , $T_{vj} = 125^{\circ}\text{C}$ , $R_G = 22\text{ Ohm}$ $L_S = 75\text{ nH}$	$E_{on}$	-	4,5	-	mWs	
Abschaltverlustenergie pro Puls turn-off energy loss per pulse	$I_C = I_{Nenn}$ , $V_{CC} = 600\text{ V}$ $V_{GE} = \pm 15\text{V}$ , $T_{vj} = 125^{\circ}\text{C}$ , $R_G = 22\text{ Ohm}$ $L_S = 75\text{ nH}$	$E_{off}$	-	4,3	-	mWs	
Kurzschlußverhalten SC Data	$t_P \leq 10\mu\text{s}$ , $V_{GE} \leq 15\text{V}$ , $R_G = 22\text{ Ohm}$ $T_{vj} \leq 125^{\circ}\text{C}$ , $V_{CC} = 720\text{ V}$ $di/dt = 2800\text{ A}/\mu\text{s}$	$I_{SC}$	-	160	-	A	

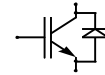

**Elektrische Eigenschaften / Electrical properties**

**Charakteristische Werte / Characteristic values**

			min.	typ.	max.	
Modulinduktivität stray inductance module		$L_{\text{GCE}}$	-	-	100	nH
Modul Leitungswiderstand, Anschlüsse-Chip lead resistance, terminals-chip	$T_C = 25^\circ\text{C}$	$R_{\text{CC}'+\text{EE}'}$	-	7	-	m $\Omega$
<b>Diode Wechselrichter/ Diode Inverter</b>			<b>min.</b>	<b>typ.</b>	<b>max.</b>	
Durchlaßspannung forward voltage	$V_{\text{GE}} = 0\text{V}, T_{\text{vj}} = 25^\circ\text{C}, I_{\text{F}} = 35\text{ A}$ $V_{\text{GE}} = 0\text{V}, T_{\text{vj}} = 125^\circ\text{C}, I_{\text{F}} = 35\text{ A}$	$V_{\text{F}}$	-	1,95 1,8	2,45 -	V V
Rückstromspitze peak reverse recovery current	$I_{\text{F}}=I_{\text{Nenn}}, -di_{\text{F}}/dt = 1400\text{A}/\mu\text{s}$ $V_{\text{GE}} = -10\text{V}, T_{\text{vj}} = 25^\circ\text{C}, V_{\text{R}} = 600\text{ V}$ $V_{\text{GE}} = -10\text{V}, T_{\text{vj}} = 125^\circ\text{C}, V_{\text{R}} = 600\text{ V}$	$I_{\text{RM}}$	-	40 45	- -	A A
Sperrverzögerungsladung recovered charge	$I_{\text{F}}=I_{\text{Nenn}}, -di_{\text{F}}/dt = 1400\text{A}/\mu\text{s}$ $V_{\text{GE}} = -10\text{V}, T_{\text{vj}} = 25^\circ\text{C}, V_{\text{R}} = 600\text{ V}$ $V_{\text{GE}} = -10\text{V}, T_{\text{vj}} = 125^\circ\text{C}, V_{\text{R}} = 600\text{ V}$	$Q_{\text{r}}$	-	3,5 7,5	- -	$\mu\text{As}$ $\mu\text{As}$
Abschaltenergie pro Puls reverse recovery energy	$I_{\text{F}}=I_{\text{Nenn}}, -di_{\text{F}}/dt = 1400\text{A}/\mu\text{s}$ $V_{\text{GE}} = -10\text{V}, T_{\text{vj}} = 25^\circ\text{C}, V_{\text{R}} = 600\text{ V}$ $V_{\text{GE}} = -10\text{V}, T_{\text{vj}} = 125^\circ\text{C}, V_{\text{R}} = 600\text{ V}$	$E_{\text{RO}}$	-	1,3 2,5	- -	mWs mWs
<b>Transistor Brems-Chopper/ Transistor Brake-Chopper</b>			<b>min.</b>	<b>typ.</b>	<b>max.</b>	
Kollektor-Emitter Sättigungsspannung collector-emitter saturation voltage	$V_{\text{GE}} = 15\text{V}, T_{\text{vj}} = 25^\circ\text{C}, I_{\text{C}} = 17,5\text{ A}$ $V_{\text{GE}} = 15\text{V}, T_{\text{vj}} = 125^\circ\text{C}, I_{\text{C}} = 17,5\text{ A}$	$V_{\text{CE sat}}$	-	2,3 2,7	2,75 -	V V
Gate-Schwellenspannung gate threshold voltage	$V_{\text{CE}} = V_{\text{GE}}, T_{\text{vj}} = 25^\circ\text{C}, I_{\text{C}} = 0,6\text{mA}$	$V_{\text{GE(TO)}}$	4,5	5,5	6,5	V
Eingangskapazität input capacitance	$f = 1\text{MHz}, T_{\text{vj}} = 25^\circ\text{C}$ $V_{\text{CE}} = 25\text{ V}, V_{\text{GE}} = 0\text{ V}$	$C_{\text{ies}}$	-	1,0	-	nF
Kollektor-Emitter Reststrom collector-emitter cut-off current	$V_{\text{GE}} = 0\text{V}, T_{\text{vj}} = 25^\circ\text{C}, V_{\text{CE}} = 1200\text{ V}$ $V_{\text{GE}} = 0\text{V}, T_{\text{vj}} = 125^\circ\text{C}, V_{\text{CE}} = 1200\text{ V}$	$I_{\text{CES}}$	-	1,0 1,2	500 -	$\mu\text{A}$ mA
Gate-Emitter Reststrom gate-emitter leakage current	$V_{\text{CE}} = 0\text{V}, V_{\text{GE}} = 20\text{V}, T_{\text{vj}} = 25^\circ\text{C}$	$I_{\text{GES}}$	-	-	300	nA
<b>Diode Brems-Chopper/ Diode Brake-Chopper</b>			<b>min.</b>	<b>typ.</b>	<b>max.</b>	
Durchlaßspannung forward voltage	$T_{\text{vj}} = 25^\circ\text{C}, I_{\text{F}} = 17,5\text{ A}$ $T_{\text{vj}} = 125^\circ\text{C}, I_{\text{F}} = 17,5\text{ A}$	$V_{\text{F}}$	-	2,7 2,6	3,05 -	V V
<b>NTC-Widerstand/ NTC-Thermistor</b>			<b>min.</b>	<b>typ.</b>	<b>max.</b>	
Nennwiderstand rated resistance	$T_C = 25^\circ\text{C}$	$R_{25}$	-	5	-	k $\Omega$
Abweichung von $R_{100}$ deviation of $R_{100}$	$T_C = 100^\circ\text{C}, R_{100} = 493\ \Omega$	$\Delta R/R$	-5		5	%
Verlustleistung power dissipation	$T_C = 25^\circ\text{C}$	$P_{25}$			20	mW
B-Wert B-value	$R_2 = R_1 \exp [B(1/T_2 - 1/T_1)]$	$B_{25/50}$		3375		K

# Technische Information / Technical Information

IGBT-Module  
IGBT-Modules

## BSM35GP120

eupec

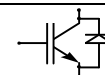

### Thermische Eigenschaften / Thermal properties

			min.	typ.	max.	
Innerer Wärmewiderstand thermal resistance, junction to case	Gleicher. Diode/ Rectif. Diode	$R_{thJC}$	-	-	1	K/W
	Trans. Wechr./ Trans. Inverter		-	-	0,55	K/W
	Diode Wechr./ Diode Inverter		-	-	0,8	K/W
	Trans. Bremse/ Trans. Brake		-	-	0,7	K/W
	Diode Bremse/ Diode Brake		-	-	2,3	K/W
Übergangs-Wärmewiderstand thermal resistance, case to heatsink	Gleicher. Diode/ Rectif. Diode	$R_{thCK}$	-	0,08	-	K/W
	Trans. Wechr./ Trans. Inverter	$\lambda_{paste}=1W/m^2K$	-	0,04	-	K/W
	Diode Wechr./ Diode Inverter	$\lambda_{grease}=1W/m^2K$	-	0,08	-	K/W
Höchstzulässige Sperrschichttemperatur maximum junction temperature		$T_{vj}$	-	-	150	°C
Betriebstemperatur operation temperature		$T_{op}$	-40	-	125	°C
Lagertemperatur storage temperature		$T_{stg}$	-40	-	125	°C

### Mechanische Eigenschaften / Mechanical properties

Innere Isolation internal insulation				$Al_2O_3$	
CTI comperative tracking index				225	
Anzugsdrehmoment f. mech. Befestigung mounting torque		M		3 $\pm 10\%$	Nm
Gewicht weight		G		180	g

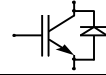

**Ausgangskennlinienfeld Wechselr. (typisch)**

$I_C = f(V_{CE})$

**Output characteristic Inverter (typical)**

$V_{GE} = 15\text{ V}$

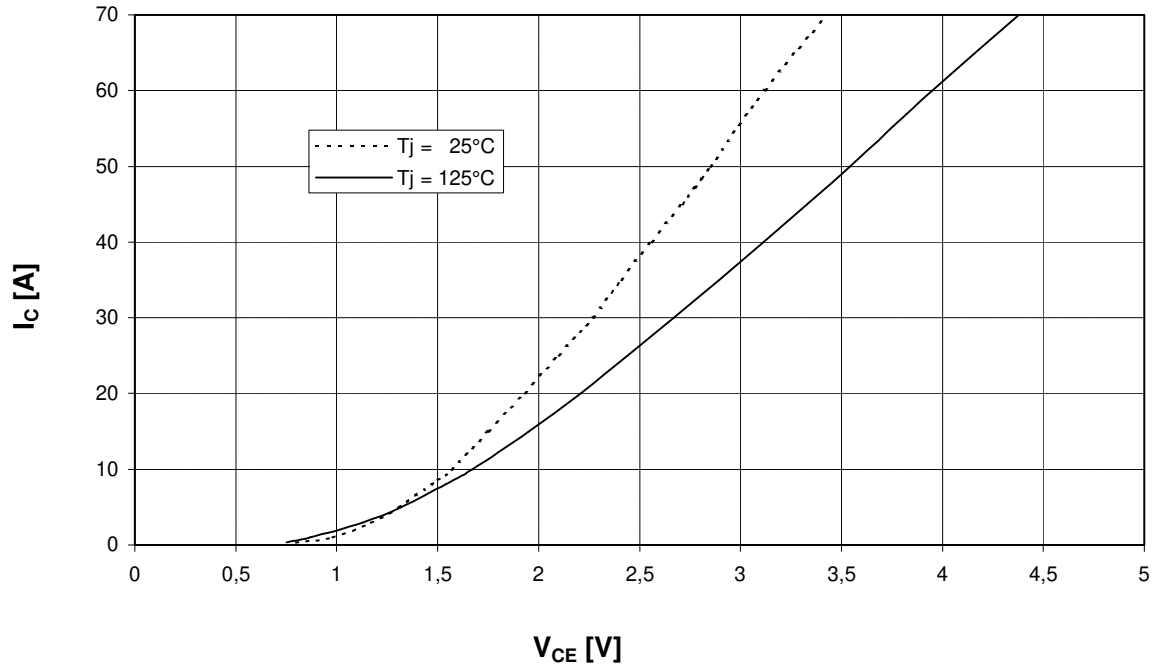

**Ausgangskennlinienfeld Wechselr. (typisch)**

$I_C = f(V_{CE})$

**Output characteristic Inverter (typical)**

$T_{vj} = 125^\circ\text{C}$

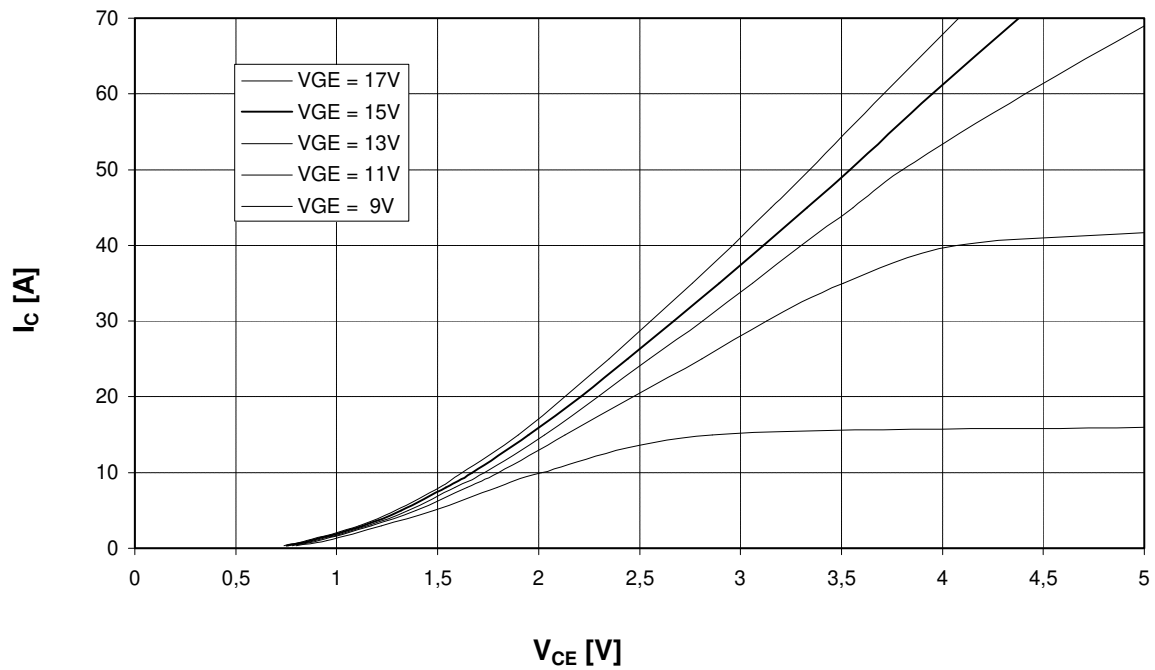

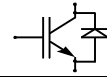

**Übertragungscharakteristik Wechselr. (typisch)**

$I_C = f(V_{GE})$

**Transfer characteristic Inverter (typical)**

$V_{CE} = 20\text{ V}$

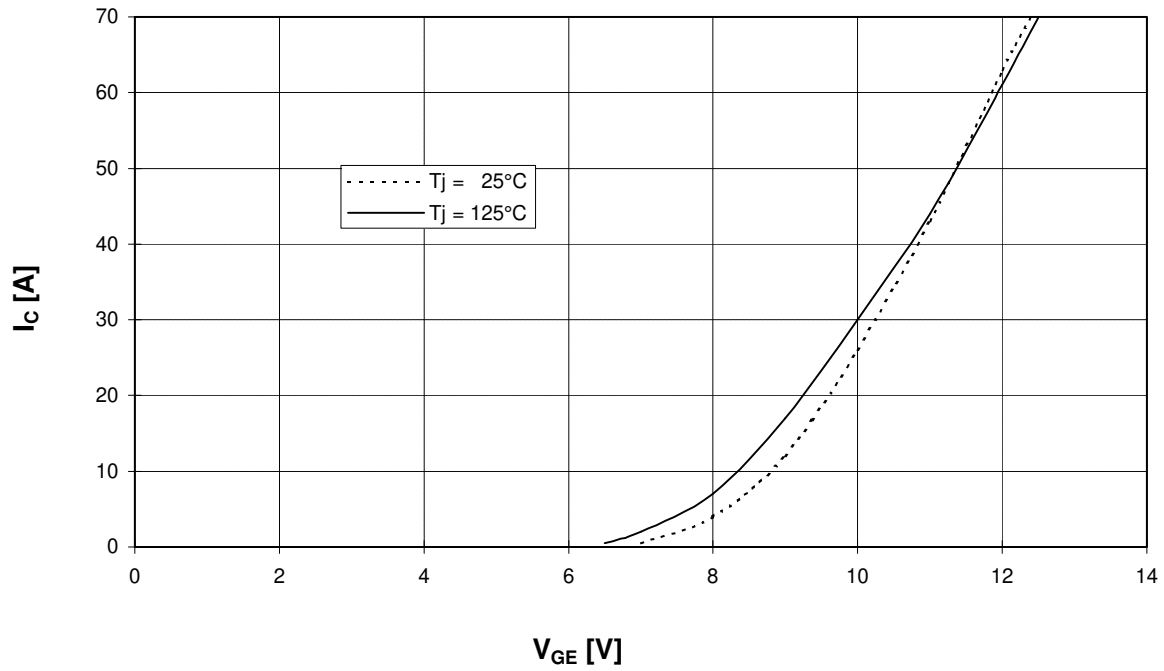

**Durchlaßkennlinie der Freilaufdiode Wechselr. (typisch)**

$I_F = f(V_F)$

**Forward characteristic of FWD Inverter (typical)**

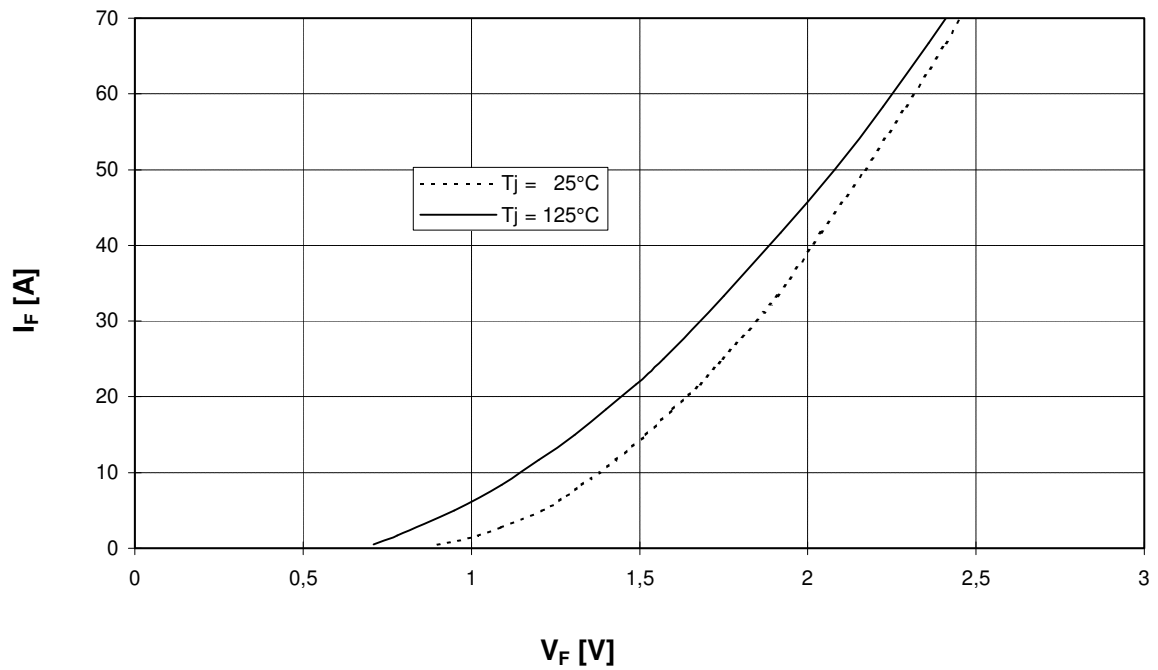

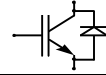

Schaltverluste Wechselr. (typisch)  $E_{on} = f(I_C), E_{off} = f(I_C), E_{rec} = f(I_C)$   $V_{CC} = 600\text{ V}$   
 Switching losses Inverter (typical)  $T_j = 125^\circ\text{C}, V_{GE} = \pm 15\text{ V}, R_{Gon} = R_{Goff} = 22\text{ Ohm}$

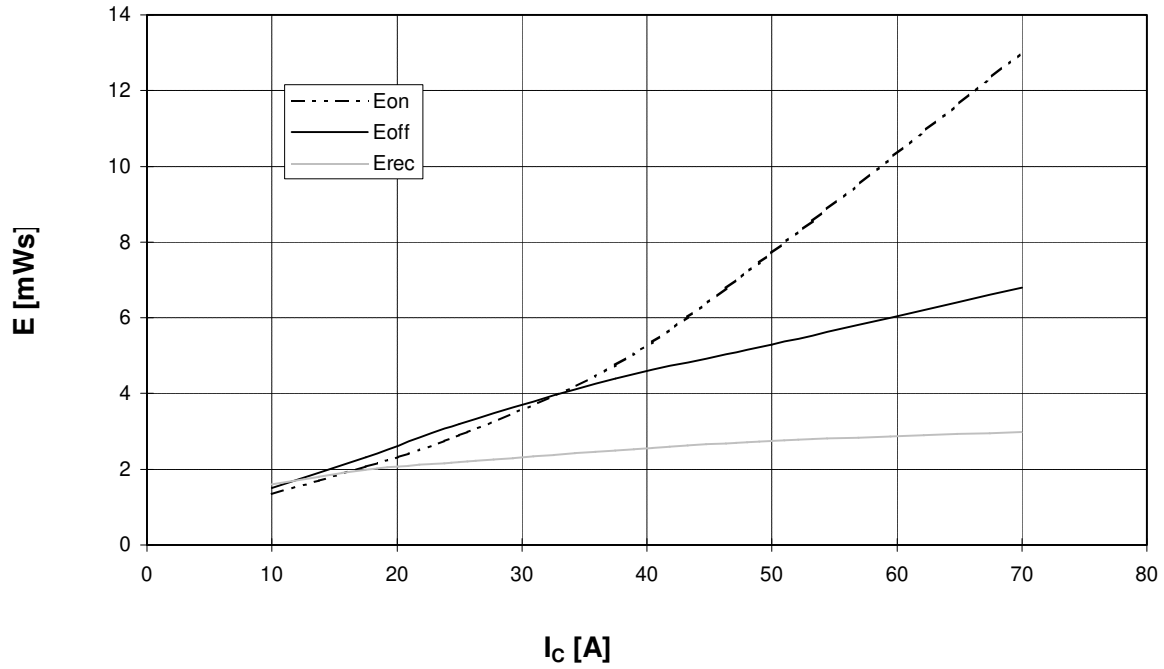

Schaltverluste Wechselr. (typisch)  $E_{on} = f(R_G), E_{off} = f(R_G), E_{rec} = f(R_G)$   
 Switching losses Inverter (typical)  $T_j = 125^\circ\text{C}, V_{GE} = \pm 15\text{ V}, I_C = I_{nenn}, V_{CC} = 600\text{ V}$

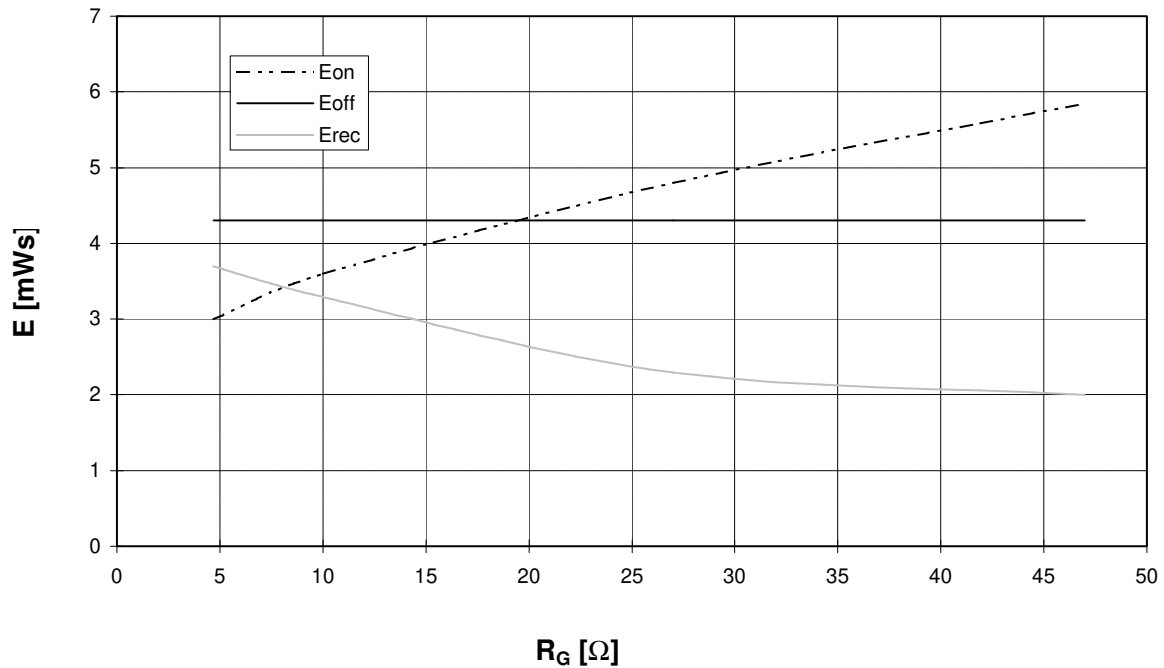



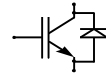

Transienter Wärmewiderstand Wechsler.  
Transient thermal impedance Inverter

$Z_{thJC} = f(t)$

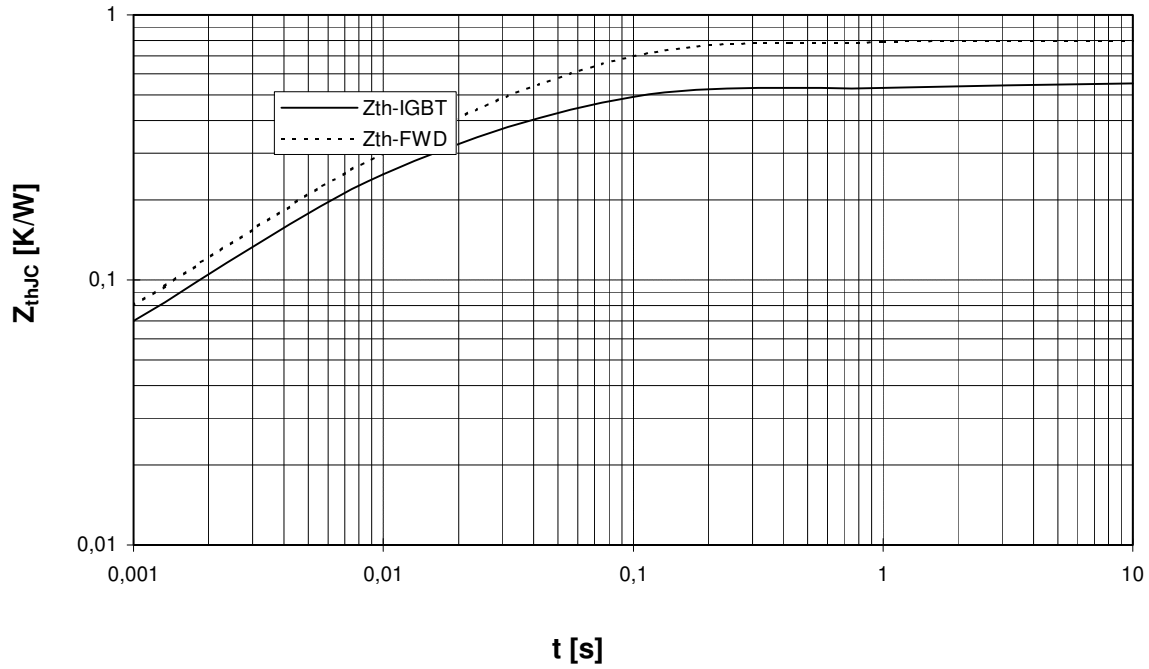

Sicherer Arbeitsbereich Wechsler. (RBSOA)

$I_C = f(V_{CE})$

Reverse bias safe operating area Inverter (RBSOA)  $T_{vj} = 125^\circ\text{C}$ ,  $V_{GE} = \pm 15\text{V}$ ,  $R_G = 22 \text{ Ohm}$

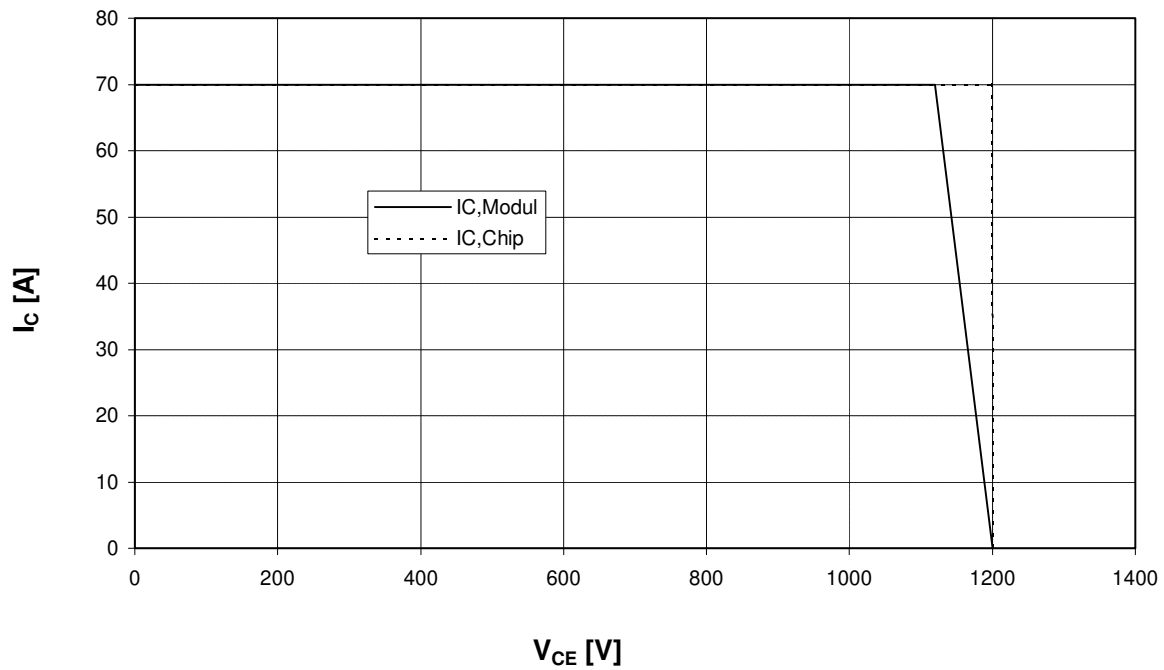

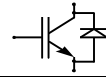

**Ausgangskennlinienfeld Brems-Chopper-IGBT (typisch)**

$I_C = f(V_{CE})$

**Output characteristic brake-chopper-IGBT (typical)**

$V_{GE} = 15\text{ V}$

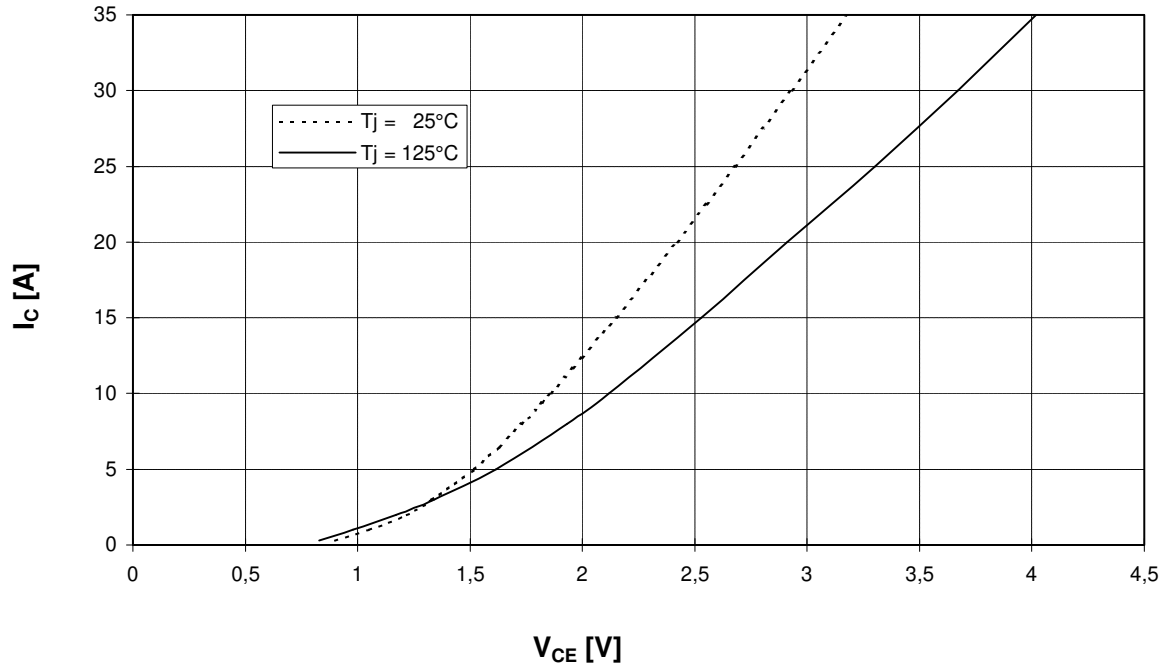

**Durchlaßkennlinie der Brems-Chopper-Diode (typisch)**

$I_F = f(V_F)$

**Forward characteristic of brake-chopper-FWD (typical)**

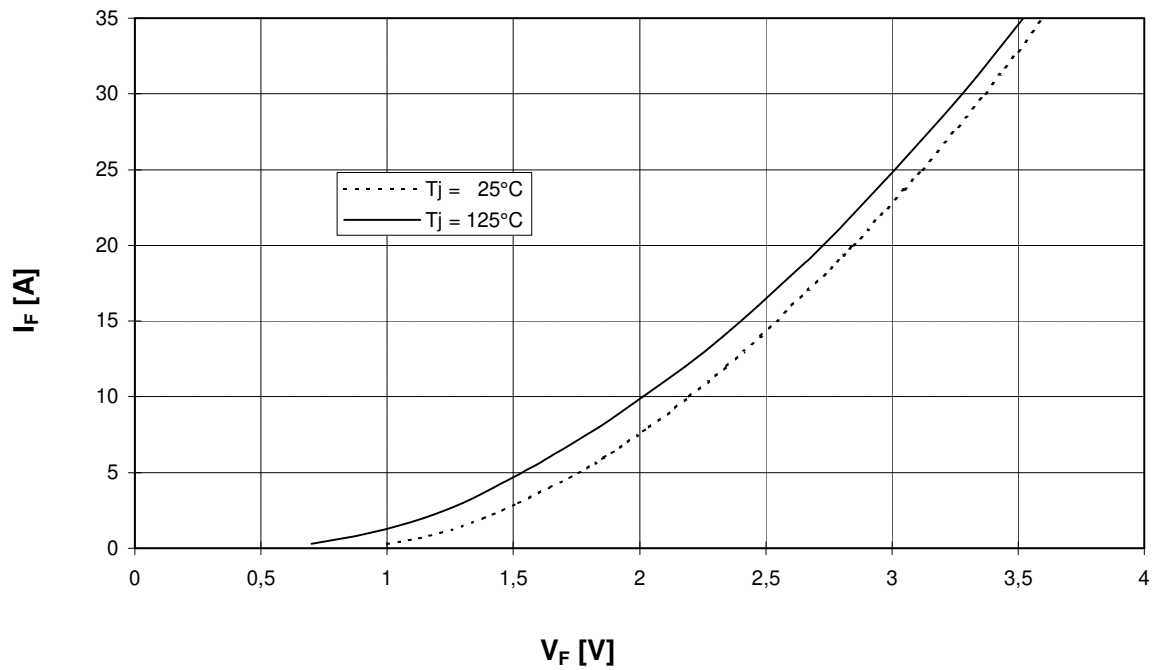

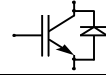

Durchlaßkennlinie der Gleichrichterdiode (typisch)  $I_F = f(V_F)$   
Forward characteristic of Rectifier Diode (typical)

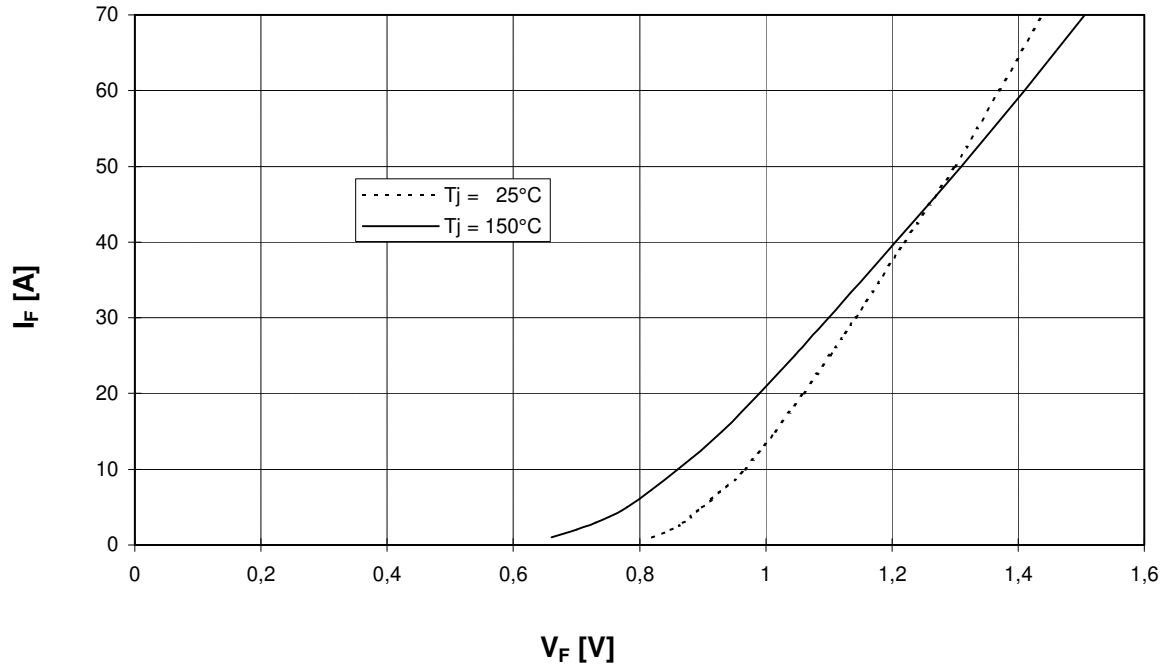

NTC- Temperaturkennlinie (typisch)  $R = f(T)$   
NTC- temperature characteristic (typical)

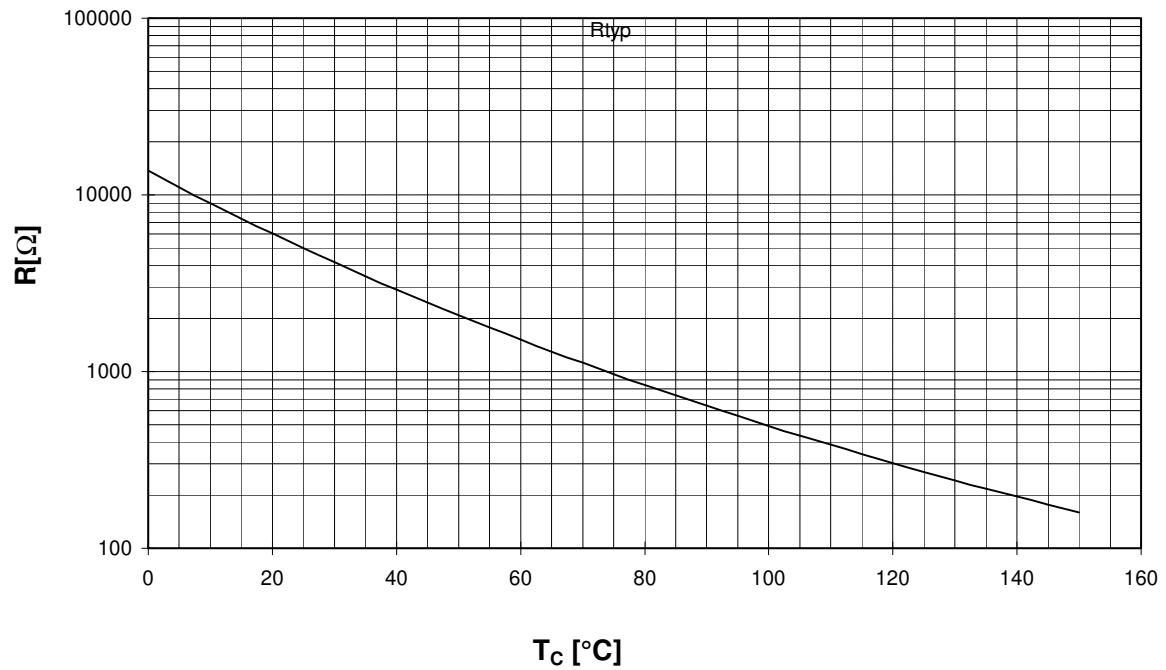

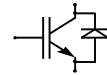

Schaltplan/ Circuit diagram

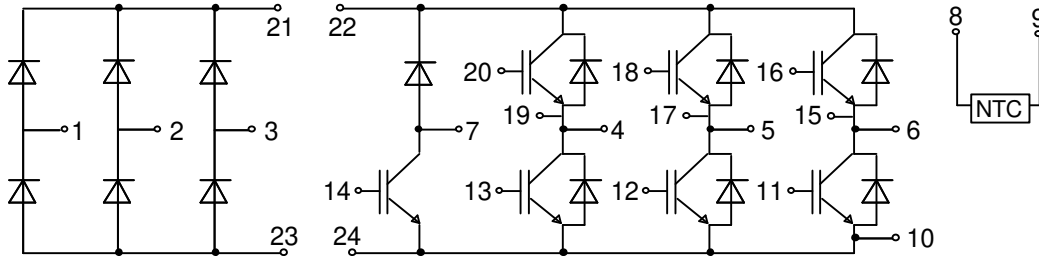

Gehäuseabmessungen/ Package outlines

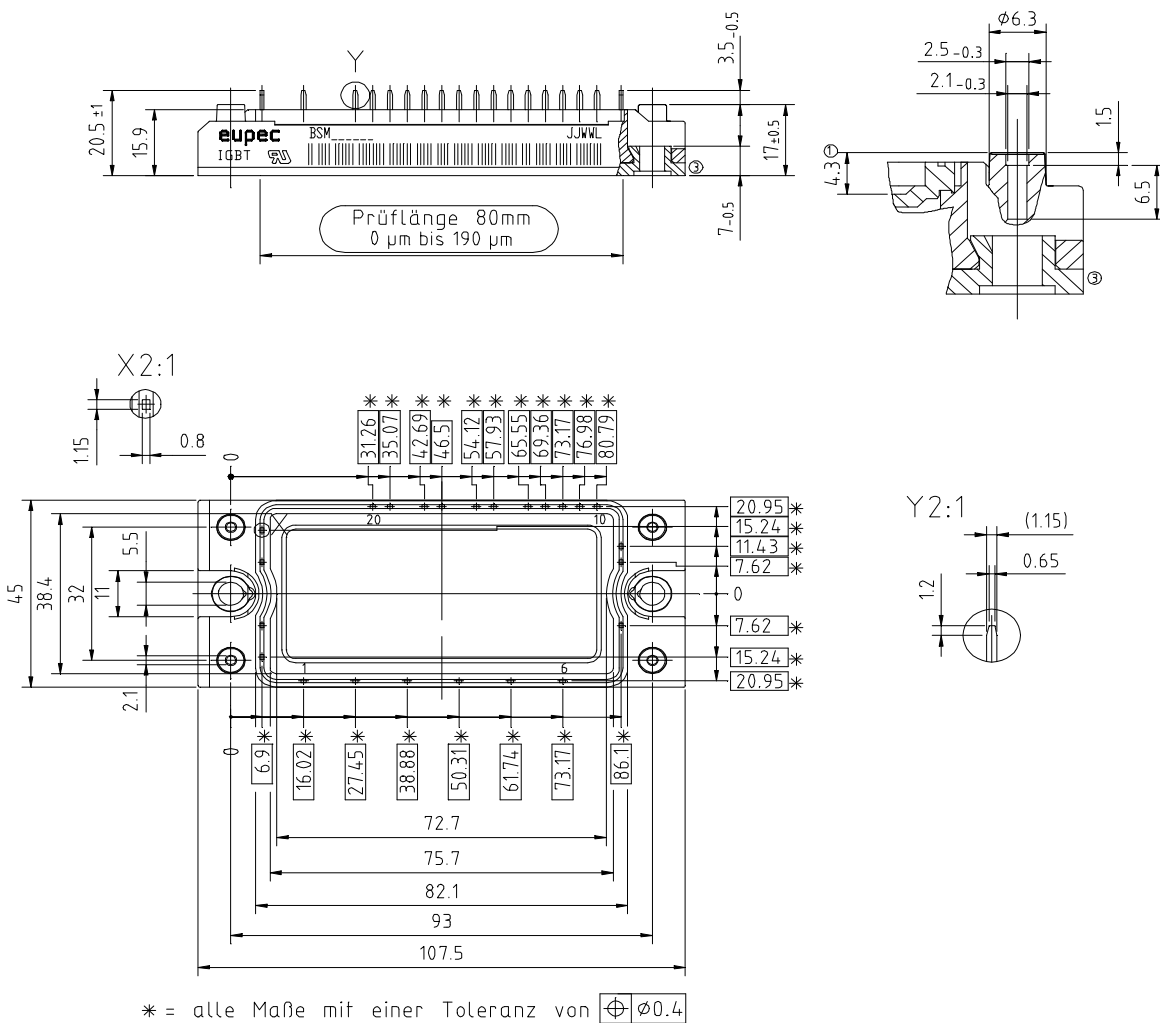

Mit dieser technischen Information werden Halbleiterbauelemente spezifiziert, jedoch keine Eigenschaften zugesichert. Sie gilt in Verbindung mit den zugehörigen Technischen Erläuterungen.

This technical information specifies semiconductor devices but promises no characteristics. It is valid in combination with the belonging technical notes.

## Nutzungsbedingungen

Die in diesem Produktdatenblatt enthaltenen Daten sind ausschließlich für technisch geschultes Fachpersonal bestimmt. Die Beurteilung der Geeignetheit dieses Produktes für die von Ihnen anvisierte Anwendung sowie die Beurteilung der Vollständigkeit der bereitgestellten Produktdaten für diese Anwendung obliegt Ihnen bzw. Ihren technischen Abteilungen.

In diesem Produktdatenblatt werden diejenigen Merkmale beschrieben, für die wir eine liefervertragliche Gewährleistung übernehmen. Eine solche Gewährleistung richtet sich ausschließlich nach Maßgabe der im jeweiligen Liefervertrag enthaltenen Bestimmungen. Garantien jeglicher Art werden für das Produkt und dessen Eigenschaften keinesfalls übernommen.

Sollten Sie von uns Produktinformationen benötigen, die über den Inhalt dieses Produktdatenblatts hinausgehen und insbesondere eine spezifische Verwendung und den Einsatz dieses Produktes betreffen, setzen Sie sich bitte mit dem für Sie zuständigen Vertriebsbüro in Verbindung (siehe [www.eupec.com](http://www.eupec.com), Vertrieb&Kontakt). Für Interessenten halten wir Application Notes bereit.

Aufgrund der technischen Anforderungen könnte unser Produkt gesundheitsgefährdende Substanzen enthalten. Bei Rückfragen zu den in diesem Produkt jeweils enthaltenen Substanzen setzen Sie sich bitte ebenfalls mit dem für Sie zuständigen Vertriebsbüro in Verbindung.

Sollten Sie beabsichtigen, das Produkt in Anwendungen der Luftfahrt, in gesundheits- oder lebensgefährdenden oder lebenserhaltenden Anwendungsbereichen einzusetzen, bitten wir um Mitteilung. Wir weisen darauf hin, dass wir für diese Fälle

- die gemeinsame Durchführung eines Risiko- und Qualitätsassessments;
- den Abschluss von speziellen Qualitätssicherungsvereinbarungen;
- die gemeinsame Einführung von Maßnahmen zu einer laufenden Produktbeobachtung dringend empfehlen und gegebenenfalls die Belieferung von der Umsetzung solcher Maßnahmen abhängig machen.

Soweit erforderlich, bitten wir Sie, entsprechende Hinweise an Ihre Kunden zu geben.

Inhaltliche Änderungen dieses Produktdatenblatts bleiben vorbehalten.

## Terms & Conditions of usage

The data contained in this product data sheet is exclusively intended for technically trained staff. You and your technical departments will have to evaluate the suitability of the product for the intended application and the completeness of the product data with respect to such application.

This product data sheet is describing the characteristics of this product for which a warranty is granted. Any such warranty is granted exclusively pursuant the terms and conditions of the supply agreement. There will be no guarantee of any kind for the product and its characteristics.

Should you require product information in excess of the data given in this product data sheet or which concerns the specific application of our product, please contact the sales office, which is responsible for you (see [www.eupec.com](http://www.eupec.com), sales&contact). For those that are specifically interested we may provide application notes.

Due to technical requirements our product may contain dangerous substances. For information on the types in question please contact the sales office, which is responsible for you.

Should you intend to use the Product in aviation applications, in health or life endangering or life support applications, please notify.

Please note, that for any such applications we urgently recommend

- to perform joint Risk and Quality Assessments;
- the conclusion of Quality Agreements;
- to establish joint measures of an ongoing product survey, and that we may make delivery depended on the realization of any such measures.

If and to the extent necessary, please forward equivalent notices to your customers.

Changes of this product data sheet are reserved.