



Chipsmall Limited consists of a professional team with an average of over 10 year of expertise in the distribution of electronic components. Based in Hongkong, we have already established firm and mutual-benefit business relationships with customers from,Europe,America and south Asia,supplying obsolete and hard-to-find components to meet their specific needs.

With the principle of “Quality Parts,Customers Priority,Honest Operation,and Considerate Service”,our business mainly focus on the distribution of electronic components. Line cards we deal with include Microchip,ALPS,ROHM,Xilinx,Pulse,ON,Everlight and Freescale. Main products comprise IC,Modules,Potentiometer,IC Socket,Relay,Connector.Our parts cover such applications as commercial,industrial, and automotives areas.

We are looking forward to setting up business relationship with you and hope to provide you with the best service and solution. Let us make a better world for our industry!



Contact us

Tel: +86-755-8981 8866 Fax: +86-755-8427 6832

Email & Skype: info@chipsmall.com Web: www.chipsmall.com

Address: A1208, Overseas Decoration Building, #122 Zhenhua RD., Futian, Shenzhen, China



SIPMOS[®] Small-Signal-Transistor

Feature

- N-Channel
- Enhancement mode, Logic Level
- dv/dt rated
- Pb-free lead plating; RoHS compliant
- Qualified according to AEC Q101
- Halogen-free according to IEC 61249-2-21

Product Summary

V_{DS}	240	V
$R_{DS(on)}$	6	Ω
I_D	0.26	A

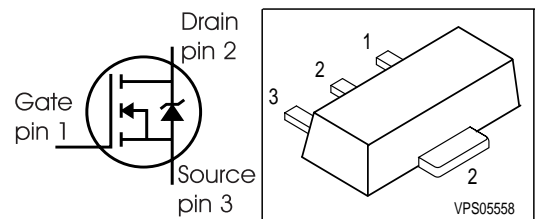

Type	Package	Pb-free	Tape and Reel Information	Marking
BSS87	P-SOT89-4-2	Yes	H6327: 1000 pcs/reel	KA

Maximum Ratings, at $T_j = 25\text{ }^\circ\text{C}$, unless otherwise specified

Parameter	Symbol	Value	Unit
Continuous drain current $T_A=25\text{ }^\circ\text{C}$ $T_A=70\text{ }^\circ\text{C}$	I_D	0.26 0.21	A
Pulsed drain current $T_A=25\text{ }^\circ\text{C}$	$I_{D\text{ puls}}$	1.04	
Reverse diode dv/dt $I_S=0.26\text{A}$, $V_{DS}=192\text{V}$, $di/dt=200\text{A}/\mu\text{s}$, $T_{jmax}=150\text{ }^\circ\text{C}$	dv/dt	6	kV/ μs
Gate source voltage	V_{GS}	± 20	V
ESD class (JESD22-A114-HBM)		1A (>250V, <500V)	
Power dissipation, related to min. footprint $T_A=25\text{ }^\circ\text{C}$	P_{tot}	1	W
Operating and storage temperature	T_j, T_{stg}	-55... +150	$^\circ\text{C}$
IEC climatic category; DIN IEC 68-1		55/150/56	

Thermal Characteristics

Parameter	Symbol	Values			Unit
		min.	typ.	max.	
Characteristics					
Thermal resistance, junction - case (Pin 2)	R_{thJC}	-	-	10	K/W
SMD version, device on PCB: @ min. footprint @ 6 cm ² cooling area ¹⁾	R_{thJA}	-	-	125 70	

Electrical Characteristics, at $T_j = 25^\circ\text{C}$, unless otherwise specified

Parameter	Symbol	Values			Unit
		min.	typ.	max.	
Static Characteristics					
Drain-source breakdown voltage $V_{GS}=0, I_D=250\mu\text{A}$	$V_{(BR)DSS}$	240	-	-	V
Gate threshold voltage, $V_{GS} = V_{DS}$ $I_D=108\mu\text{A}$	$V_{GS(th)}$	0.8	1.2	1.8	
Zero gate voltage drain current $V_{DS}=240\text{V}, V_{GS}=0, T_j=25^\circ\text{C}$ $V_{DS}=240\text{V}, V_{GS}=0, T_j=150^\circ\text{C}$	I_{DSS}	-	-	0.1 100	μA
Gate-source leakage current $V_{GS}=20\text{V}, V_{DS}=0$	I_{GSS}	-	-	10	
Drain-source on-state resistance $V_{GS}=4.5\text{V}, I_D=0.24\text{A}$	$R_{DS(on)}$	-	4.6	7.5	Ω
Drain-source on-state resistance $V_{GS}=10\text{V}, I_D=0.26\text{A}$	$R_{DS(on)}$	-	3.9	6	

¹⁾Device on 40mm*40mm*1.5mm epoxy PCB FR4 with 6cm² (one layer, 70 μm thick) copper area for drain connection. PCB is vertical without blown air.

Electrical Characteristics, at $T_j = 25\text{ }^\circ\text{C}$, unless otherwise specified

Parameter	Symbol	Conditions	Values			Unit
			min.	typ.	max.	
Dynamic Characteristics						
Transconductance	g_{fs}	$V_{DS} \geq 2 \cdot I_D \cdot R_{DS(on)max}$, $I_D = 0.21\text{A}$	0.16	0.33	-	S
Input capacitance	C_{iss}	$V_{GS} = 0, V_{DS} = 25\text{V}$, $f = 1\text{MHz}$	-	77.5	97	pF
Output capacitance	C_{oss}		-	11.2	14	
Reverse transfer capacitance	C_{rss}		-	5.8	7.3	
Turn-on delay time	$t_{d(on)}$	$V_{DD} = 120\text{V}, V_{GS} = 10\text{V}$, $I_D = 0.28\text{A}, R_G = 6\Omega$	-	3.7	5.5	ns
Rise time	t_r		-	3.5	5.2	
Turn-off delay time	$t_{d(off)}$		-	17.6	26.4	
Fall time	t_f		-	27.3	41	
Gate Charge Characteristics						
Gate to source charge	Q_{gs}	$V_{DD} = 192\text{V}, I_D = 0.26\text{A}$	-	0.14	0.21	nC
Gate to drain charge	Q_{gd}		-	1.7	2.5	
Gate charge total	Q_g	$V_{DD} = 192\text{V}, I_D = 0.26\text{A}$, $V_{GS} = 0 \text{ to } 10\text{V}$	-	3.7	5.5	
Gate plateau voltage	$V_{(plateau)}$	$V_{DD} = 192\text{V}, I_D = 0.26\text{A}$	-	2.7	-	V
Reverse Diode						
Inverse diode continuous forward current	I_S	$T_A = 25\text{ }^\circ\text{C}$	-	-	0.26	A
Inv. diode direct current, pulsed	I_{SM}		-	-	1.04	
Inverse diode forward voltage	V_{SD}	$V_{GS} = 0, I_F = I_S$	-	0.82	1.2	V
Reverse recovery time	t_{rr}	$V_R = 120\text{V}, I_F = I_S$, $di_F/dt = 100\text{A}/\mu\text{s}$	-	53.6	80.4	ns
Reverse recovery charge	Q_{rr}		-	101	152	

1 Power dissipation

$$P_{tot} = f(T_A)$$

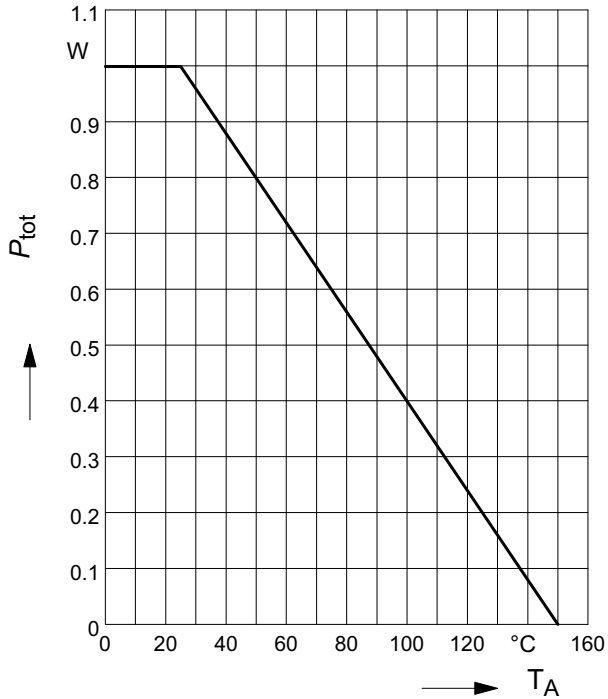

2 Drain current

$$I_D = f(T_A)$$

parameter: $V_{GS} \geq 10\text{ V}$

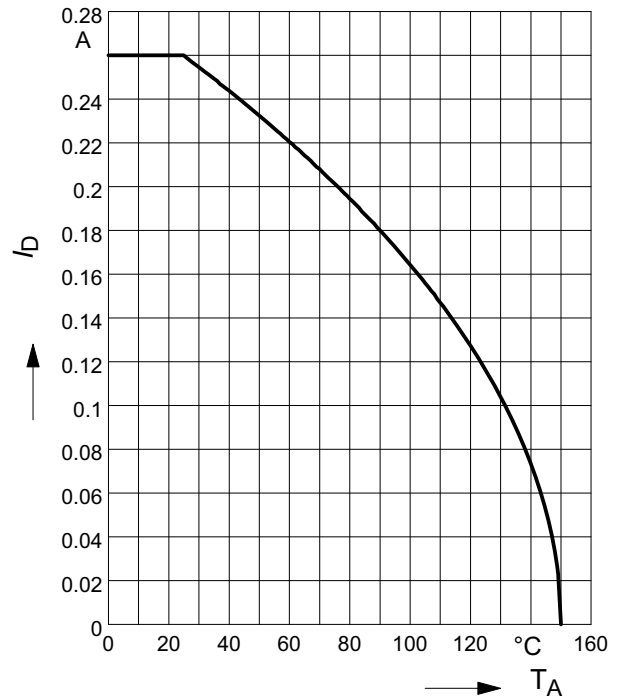

3 Safe operating area

$$I_D = f(V_{DS})$$

parameter: $D = 0, T_A = 25\text{ °C}$

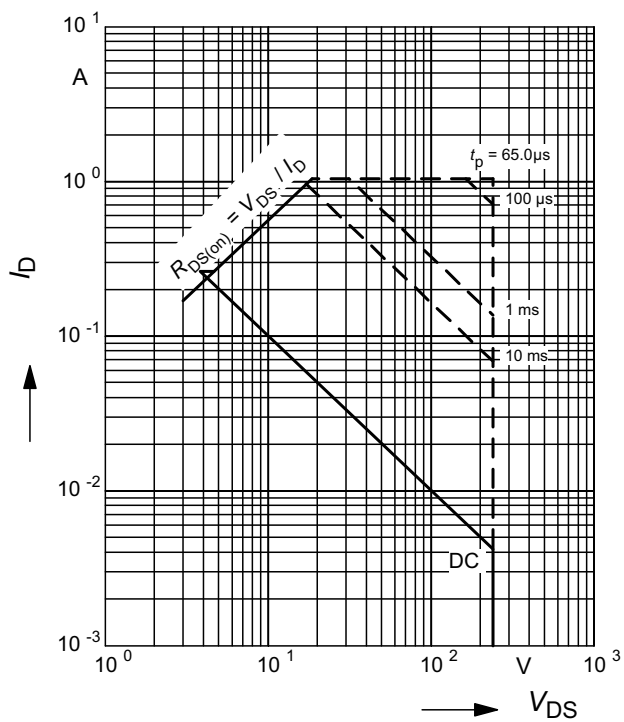

4 Transient thermal impedance

$$Z_{thJA} = f(t_p)$$

parameter: $D = t_p/T$

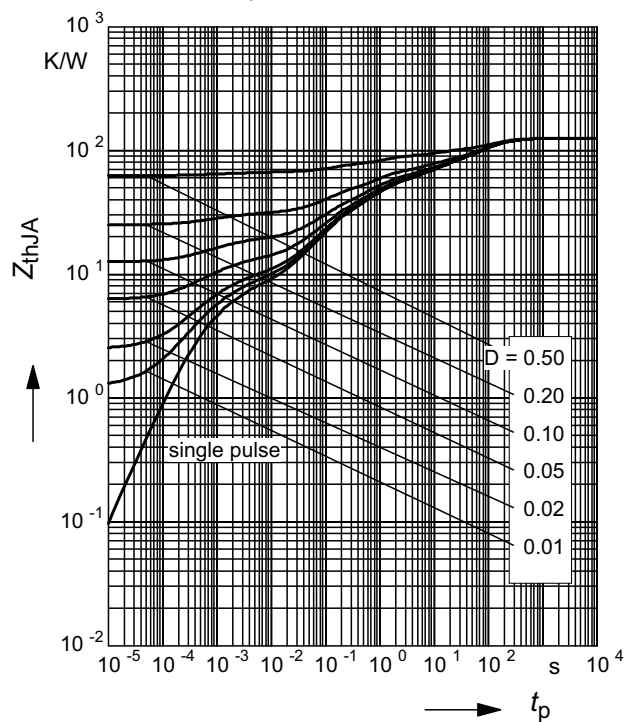

5 Typ. output characteristic

$$I_D = f(V_{DS})$$

parameter: $T_j = 25\text{ }^\circ\text{C}$, V_{GS}

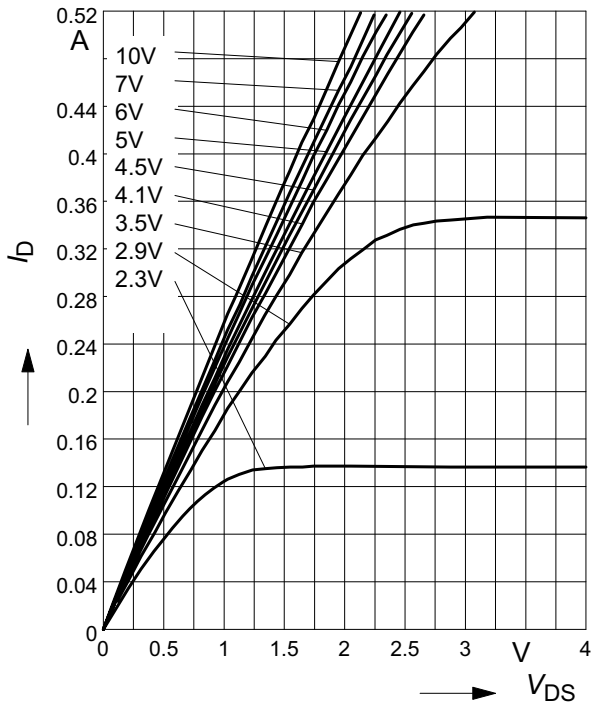

6 Typ. drain-source on resistance

$$R_{DS(on)} = f(I_D)$$

parameter: $T_j = 25\text{ }^\circ\text{C}$, V_{GS}

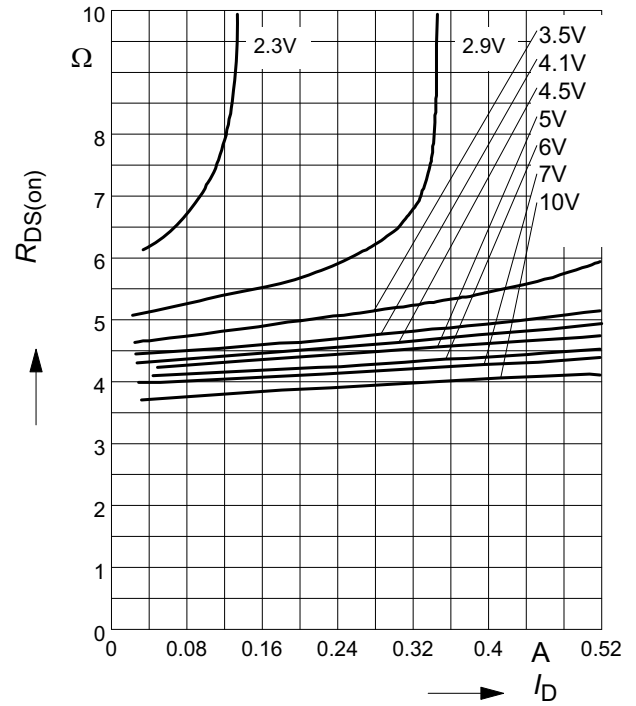

7 Typ. transfer characteristics

$$I_D = f(V_{GS}); V_{DS} \geq 2 \times I_D \times R_{DS(on)max}$$

parameter: $T_j = 25\text{ }^\circ\text{C}$

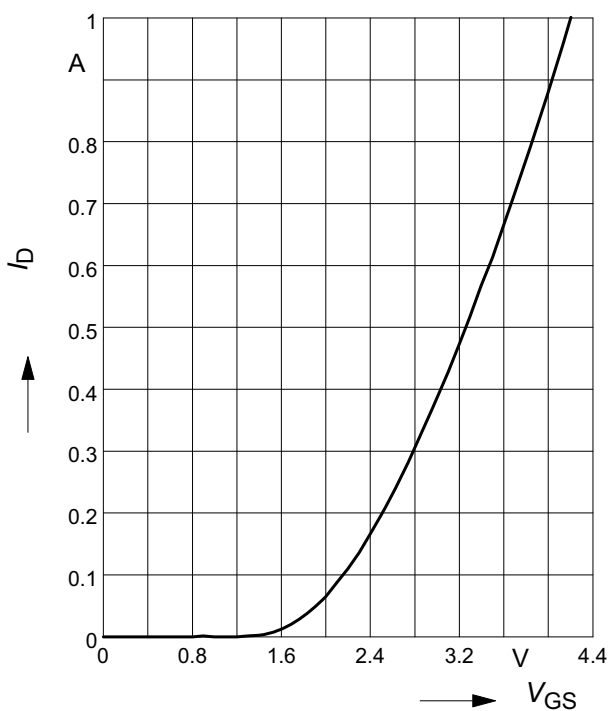

8 Typ. forward transconductance

$$g_{fs} = f(I_D)$$

parameter: $T_j = 25\text{ }^\circ\text{C}$

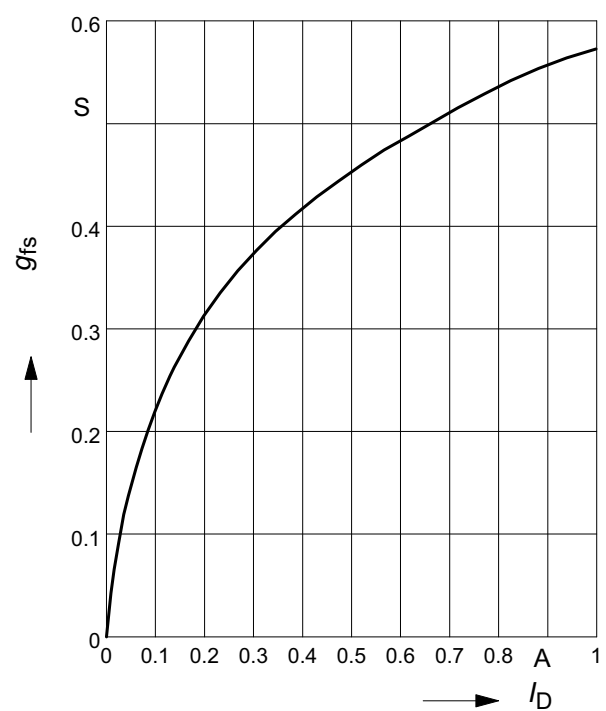

9 Drain-source on-state resistance

$$R_{DS(on)} = f(T_j)$$

parameter : $I_D = 0.26 \text{ A}$, $V_{GS} = 10 \text{ V}$

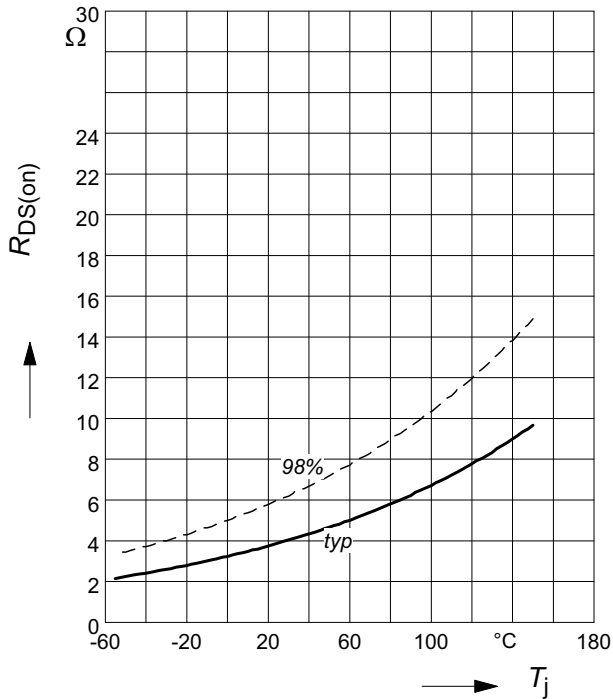

10 Typ. gate threshold voltage

$$V_{GS(th)} = f(T_j)$$

parameter: $V_{GS} = V_{DS}$; $I_D = 108 \mu\text{A}$

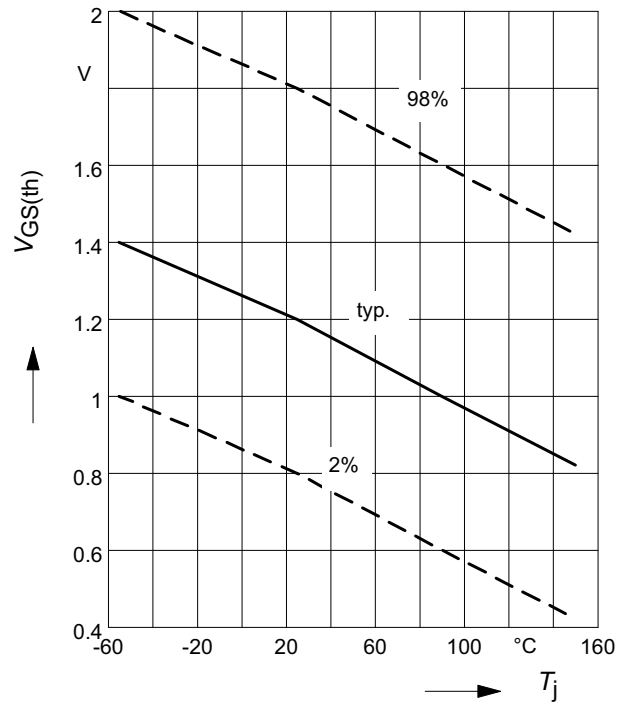

11 Typ. capacitances

$$C = f(V_{DS})$$

parameter: $V_{GS}=0$, $f=1 \text{ MHz}$, $T_j = 25 \text{ }^\circ\text{C}$

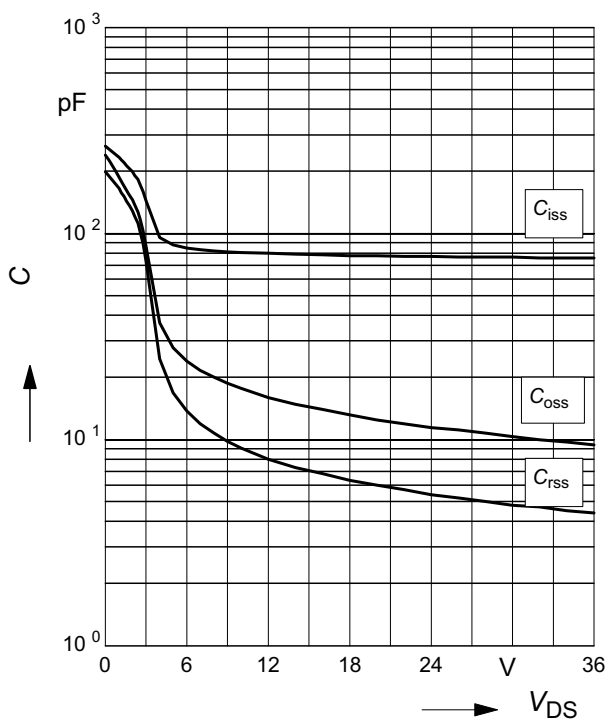

12 Forward character. of reverse diode

$$I_F = f(V_{SD})$$

parameter: T_j

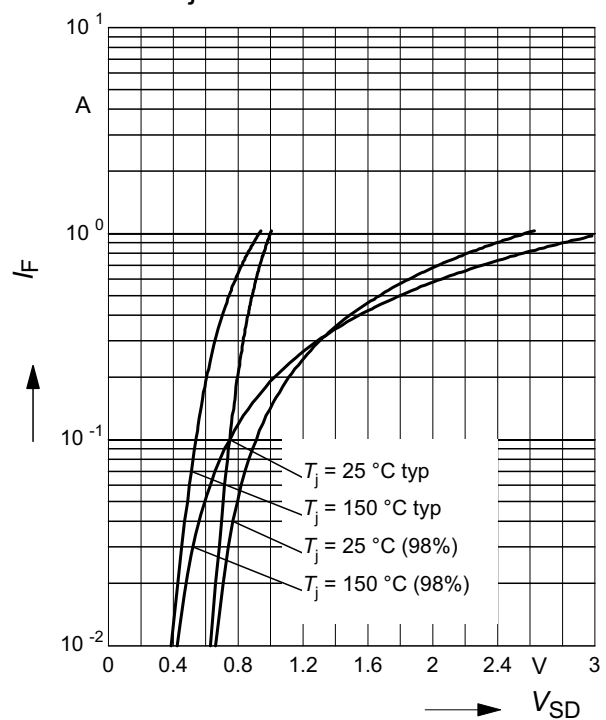

13 Typ. gate charge

$V_{GS} = f(Q_G)$; parameter: V_{DS} ,
 $I_D = 0.26 \text{ A pulsed}$, $T_j = 25 \text{ }^\circ\text{C}$

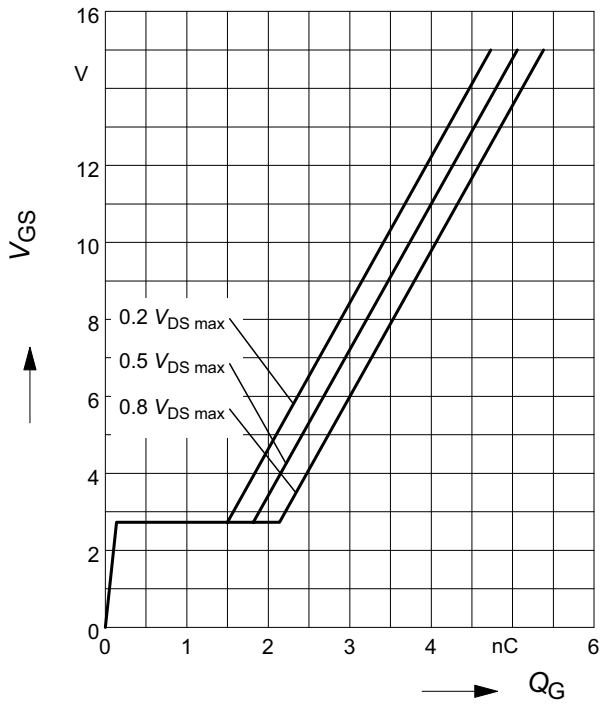

14 Drain-source breakdown voltage

$V_{(BR)DSS} = f(T_j)$

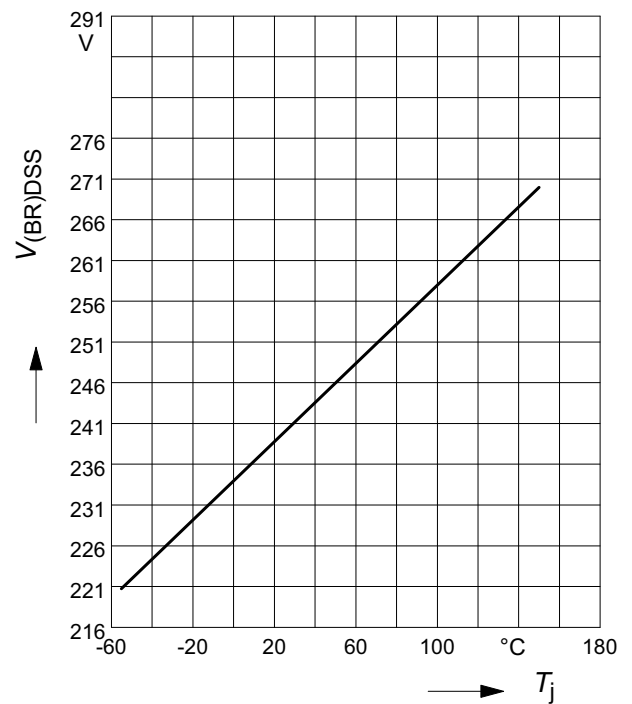

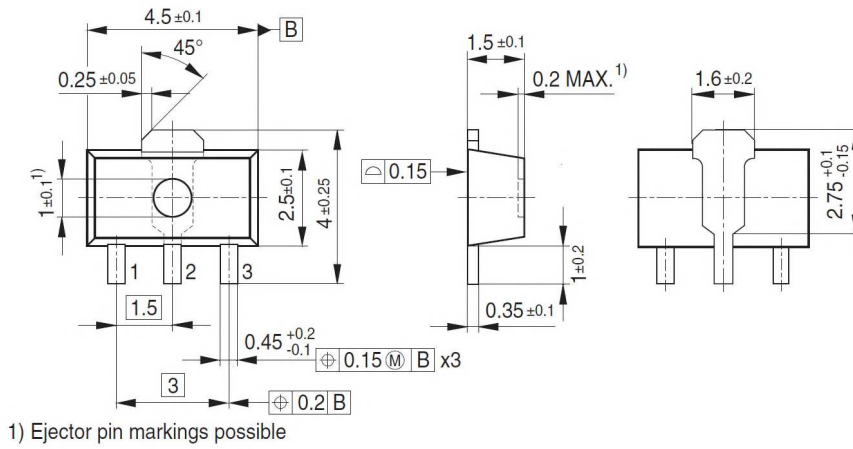
Package Outline SOT-89

Footprint

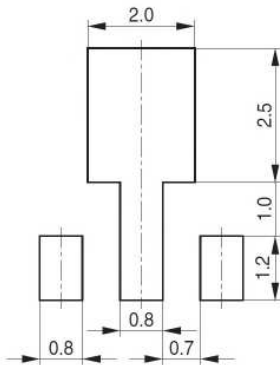
Soldering type: Reflow soldering

Tape and Reel

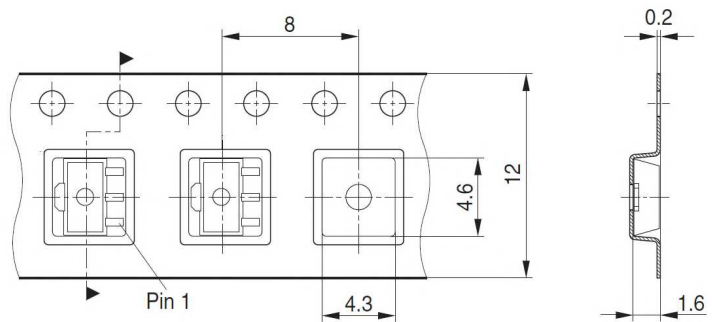
 Reel \varnothing 180 mm: 1.000 Pieces/Reel
 Reels/Box: 1 x 1.000 = 1.000

 Reel \varnothing 330 mm: 4.000 Pieces/Reel
 Reels/Box: 1 x 4.000 = 4.000

Dimensions in mm

Revision History

BSS87

Revision: 2016-06-09, Rev. 2.0

Previous Revision

Revision	Date	Subjects (major changes since last revision)
2.0	2016-06-09	Release of final version

Trademarks of Infineon Technologies AG

AURIX™, C166™, CanPAK™, CIPOS™, CoolGaN™, CoolMOS™, CoolSET™, CoolSiC™, CORECONTROL™, CROSSAVE™, DAVE™, DI-POL™, DrBlade™, EasyPIM™, EconoBRIDGE™, EconoDUAL™, EconoPACK™, EconoPIM™, EiceDRIVER™, eupec™, FCOS™, HITFET™, HybridPACK™, Infineon™, ISOFACE™, IsoPACK™, i-Wafer™, MIPAQ™, ModSTACK™, my-d™, NovalithIC™, OmniTune™, OPTIGA™, OptiMOS™, ORIGA™, POWERCODE™, PRIMARION™, PrimePACK™, PrimeSTACK™, PROFET™, PRO-SIL™, RASIC™, REAL3™, ReverSave™, SatRIC™, SIEGET™, SIPMOS™, SmartLEWIS™, SOLID FLASH™, SPOC™, TEMPFET™, thinQ!™, TRENCHSTOP™, TriCore™.

Trademarks updated August 2015

Other Trademarks

All referenced product or service names and trademarks are the property of their respective owners.

We Listen to Your Comments

Any information within this document that you feel is wrong, unclear or missing at all? Your feedback will help us to continuously improve the quality of this document. Please send your proposal (including a reference to this document) to:

erratum@infineon.com

Published by
Infineon Technologies AG
81726 München, Germany
© 2016 Infineon Technologies AG
All Rights Reserved.

Legal Disclaimer

The information given in this document shall in no event be regarded as a guarantee of conditions or characteristics. With respect to any examples or hints given herein, any typical values stated herein and/or any information regarding the application of the device, Infineon Technologies hereby disclaims any and all warranties and liabilities of any kind, including without limitation, warranties of non-infringement of intellectual property rights of any third party.

Information

For further information on technology, delivery terms and conditions and prices please contact your nearest Infineon Technologies Office (www.infineon.com).

Warnings

Due to technical requirements, components may contain dangerous substances. For information on the types in question, please contact the nearest Infineon Technologies Office.

The Infineon Technologies component described in this Data Sheet may be used in life-support devices or systems and/or automotive, aviation and aerospace applications or systems only with the express written approval of Infineon Technologies, if a failure of such components can reasonably be expected to cause the failure of that life-support, automotive, aviation and aerospace device or system or to affect the safety or effectiveness of that device or system. Life support devices or systems are intended to be implanted in the human body or to support and/or maintain and sustain and/or protect human life. If they fail, it is reasonable to assume that the health of the user or other persons may be endangered.