



Chipsmall Limited consists of a professional team with an average of over 10 year of expertise in the distribution of electronic components. Based in Hongkong, we have already established firm and mutual-benefit business relationships with customers from,Europe,America and south Asia,supplying obsolete and hard-to-find components to meet their specific needs.

With the principle of “Quality Parts,Customers Priority,Honest Operation,and Considerate Service”,our business mainly focus on the distribution of electronic components. Line cards we deal with include Microchip,ALPS,ROHM,Xilinx,Pulse,ON,Everlight and Freescale. Main products comprise IC,Modules,Potentiometer,IC Socket,Relay,Connector.Our parts cover such applications as commercial,industrial, and automotives areas.

We are looking forward to setting up business relationship with you and hope to provide you with the best service and solution. Let us make a better world for our industry!



Contact us

Tel: +86-755-8981 8866 Fax: +86-755-8427 6832

Email & Skype: info@chipsmall.com Web: www.chipsmall.com

Address: A1208, Overseas Decoration Building, #122 Zhenhua RD., Futian, Shenzhen, China





**IndustrialPro™ and MobilityPro™ Gateway
Wireless Modems**

User's Guide

Version 1.15

August 15, 2014

No part of this publication, or any software included with it, may be reproduced, stored in a retrieval system, or transmitted in any form or by any means, including photocopying, electronic, mechanical, recording or otherwise, without the prior written permission of the copyright holder.

Red Lion Controls provides this document as is, without warranty of any kind either expressed or implied including, but not limited to, the implied warranties of merchantability and fitness for a particular purpose. Red Lion may make changes of improvements in the equipment, software, or specifications described in this document at any time and without notice. These changes may be incorporated in new releases of this document.

This document may contain technical inaccuracies or typographical errors. Red Lion and its subsidiaries waive responsibility for any labor, materials, or costs incurred by any person or party as a result of using this document.

Red Lion and any of its subsidiaries or other affiliates shall not be liable for any damages (including, but not limited to, consequential, indirect or incidental, special damages, or loss of profits or data) even if they were foreseeable and Red Lion has been informed of their potential occurrence arising out of or in connection with this document or its use.

Computer Software Copyrights

The products described in this manual include copyrighted Red Lion computer programs stored in semi-conductor memories or other media. Laws in Canada, the United States and other countries preserve for Red Lion certain rights for copyrighted computer programs, including the exclusive right to copy or reproduce in any form the copyrighted computer program. Accordingly, any copyrighted Red Lion computer programs contained in the Red Lion products described in this manual may not be copied without the express written permission of Red Lion.

Furthermore, the purchase of Red Lion products shall not be deemed to grant either directly or by implication, estoppels, or otherwise, any license under the copyrights, patents or patent applications of Red Lion, except for the normal non-exclusive, royalty-free license to use that arises by operation of laws in the sale of a product.

Red Lion Controls

20 Willow Springs Circle,
York, PA 17406

Phone: 1-717-767-6511

Fax: 1-717-764-0839

Web: www.redlion.net

Federal Communication Commission Interference Statement

This equipment has been tested and found to comply with the limits for a Class B digital device, pursuant to Part 15 of the FCC Rules. These limits are designed to provide reasonable protection against harmful interference in a residential installation. This equipment generates uses and can radiate radio frequency energy and, if not installed and used in accordance with the instructions, may cause harmful interference to radio communications. However, there is no guarantee that interference will not occur in a particular installation. If this equipment does cause harmful interference to radio or television reception, which can be determined by turning the equipment off and on, the user is encouraged to try to correct the interference by one of the following measures:

- Reorient or relocate the receiving antenna.
- Increase the separation between the equipment and receiver.
- Connect the equipment into an outlet on a circuit different from that to which the receiver is connected.
- Consult the dealer or an experienced radio/TV technician for help.

This device complies with Part 15 of the FCC Rules. Operation is subject to the following two conditions: (1) This device may not cause harmful interference, and (2) this device must accept any interference received, including interference that may cause undesired operation.

FCC Caution: Any changes or modifications not expressly approved by the party responsible for compliance could void the user's authority to operate this equipment.

To comply with FCC RF exposure limits for general population/uncontrolled exposure, the antenna(s) used for this transmitter must be installed to provide a separation distance of at least 20 cm from all persons and must not be collocated or operating in conjunction with any other antenna or transmitter.

Industry Canada

This device complies with Industry Canada license-exempt RSS standard(s). Operation is subject to the following two conditions: (1) this device may not cause interference, and (2) this device must accept any interference, including interference that may cause undesired operation of the device.

This radio transmitters BT-5630v2 / BT-5830v2 (IC: 2991A-BT5X30V2) and BT-5730v2 have been approved by Industry Canada to operate with the antenna types listed below with the maximum permissible gain and required antenna impedance for each antenna type indicated. Antenna types not included in this list, having a gain greater than the maximum gain indicated for that type, are strictly prohibited for use with this device.

A portable duct-type antenna with 3dBi gain and 50 ohm impedance is the approved antenna type.

Under Industry Canada regulations, this radio transmitter may only operate using an antenna of a type and maximum (or lesser) gain approved for the transmitter by Industry Canada. To reduce potential radio interference to other users, the antenna type and its gain should be so chosen that the equivalent isotropically radiated power (e.i.r.p.) is not more than that necessary for successful communication.

To comply with Industry Canada RF exposure limits for general population/uncontrolled exposure, the antenna(s) used for this transmitter must be installed to provide a separation distance of at least 20 cm from all persons and must not be collocated or operating in conjunction with any other antenna or transmitter.

Le présent appareil est conforme aux CNR d'Industrie Canada applicables aux appareils radio exempts de licence. L'exploitation est autorisée aux deux conditions suivantes : (1) l'appareil ne doit pas produire de brouillage, et (2) l'utilisateur de l'appareil doit accepter tout brouillage radioélectrique subi, même si le brouillage est susceptible d'en compromettre le fonctionnement.

Conformément à la réglementation d'Industrie Canada, le présent émetteur radio peut fonctionner avec une antenne d'un type et d'un gain maximal (ou inférieur) approuvé pour l'émetteur par Industrie Canada. Dans le but de réduire les risques de brouillage radioélectrique à l'intention des autres utilisateurs, il faut choisir le type d'antenne et son gain de sorte que la puissance isotrope rayonnée équivalente (p.i.r.e.) ne dépasse pas l'intensité nécessaire à l'établissement d'une communication satisfaisante.

Le présent émetteur radio (identifier le dispositif par son numéro de certification ou son numéro de modèle s'il fait partie du matériel de catégorie I) a été approuvé par Industrie Canada pour fonctionner avec les types d'antenne énumérés ci-dessous et ayant un gain admissible maximal et l'impédance requise pour chaque type d'antenne. Les types d'antenne non inclus dans cette liste, ou dont le gain est supérieur au gain maximal indiqué, sont strictement interdits pour l'exploitation de l'émetteur.

Liability Notice

While every effort has been made to achieve technical accuracy, information in this document is subject to change without notice and does not represent a commitment on the part of Red Lion Controls, or any of its subsidiaries, affiliates, agents, licensors, or resellers. There are no warranties, express or implied, with respect to the content of this document.

These products should not be used to replace proper safety interlocking. No software-based device (or any other solid-state device) should ever be designed to be responsible for the maintenance of consequential equipment or personnel safety. In particular, Red Lion disclaims any responsibility for damages, either direct or consequential, that result from the use of this equipment in any application.

All power, input and output (I/O) wiring must be in accordance with Class I, Division 2 wiring methods and in accordance with the authority having jurisdiction.

Suitable for use in Class I, Division 2, Groups A, B, C and D hazardous locations, or non-hazardous locations only.

WARNING – EXPLOSION HAZARD – SUBSTITUTION OF COMPONENTS MAY IMPAIR SUITABILITY FOR CLASS 1, DIVISION 2.

WARNING – EXPLOSION HAZARD – WHEN IN HAZARDOUS LOCATIONS, DISCONNECT POWER BEFORE REPLACING OR WIRING MODULES.

WARNING – EXPLOSION HAZARD – DO NOT DISCONNECT EQUIPMENT UNLESS POWER HAS BEEN SWITCHED OFF OR THE AREA IS KNOWN TO BE NONHAZARDOUS.

These products are operator interface units to be used within control panels. These devices are intended for use in Class I, Division 2, Hazardous Locations, industrial control applications. The enclosure shall be suitable for the location.

AVERTISSEMENTS POUR INSTALLATION ET ENDROITS DANGEREUX

Ces produits ne doivent pas être utilisés pour remplacer le verrouillage de sécurité approprié. Aucun dispositif basé sur un logiciel (ou tout autre dispositif à l'état solide) devraient jamais être conçus pour être responsable de l'entretien de l'équipement consécutifs ou la sécurité du personnel. En particulier, Red Lion décline toute responsabilité pour les dommages, directs ou indirects, résultant de l'utilisation de cet équipement dans n'importe quelle application.

Tout courant, câblage entrée et sortie (I / O) doit être conforme aux méthodes de câblage à la Classe I, Division 2 et conformément à l'autorité compétente.

Cet appareil est adapté pour utilisation en Classe I, Division 2, Groupes A, B, C, D endroits dangereux ou endroits non-dangereux.

AVERTISSEMENT – RISQUE D'EXPLOSION – LA SUBSTITUTION DE TOUT COMPOSANT PEUT NUIRE À LA CONFORMITÉ DE CLASSE I, DIVISION 2

AVERTISSEMENT – RISQUE D'EXPLOSION – LORSQUE DANS DES ENDROITS DANGEREUX, DÉBRANCHEZ LE CORDON D'ALIMENTATION AVANT DE REMPLACER OU DE BRANCHER LES MODULES.

AVERTISSEMENT – RISQUE D'EXPLOSION – NE DÉBRANCHEZ PAS L'ÉQUIPEMENT À MOINS QUE L'ALIMENTATION AIT ÉTÉ COUPÉE OU QUE L'ENVIRONNEMENT EST CONNU POUR ÊTRE NON DANGEREUX.

Ces produits sont des unités d'interface opérateur qui doivent être utilisés à l'intérieur des panneaux de commande. Ces appareils sont destinés à une utilisation en Classe I, Division 2, zones dangereuses, applications de contrôle industriel. L'enclos doit être adapté à l'environnement.

Change history

Version	Date	Description
1.15	May 23, 2014	Add UL Warnings
1.14	November 30, 2012	Updated to cover BT-57xx LTE models
1.13	February 15, 2012	Updated to cover BT-5x30 Wi-Fi models
1.10	September 27, 2010	Update event and store and forward sections Update environmental specifications
1.9	June 7, 2010	Add modem pictures Red Lion labels
1.8	March 30, 2010	Change document format

Table of content

1	Product Overview	10
1.1	Introduction	10
1.2	Modem features	11
1.3	Specifications	13
2	BlueVue Device Manager (BVDM)	24
2.1	Connecting to the modem	25
2.2	Software overview	27
3	AT Commands	28
3.1	Access	28
4	Activation & WAN Setup	29
4.1	Activation (CDMA modems only)	29
4.2	WAN Setup	30
5	LAN Setup	33
5.1	Ethernet and USB LAN	33
5.2	LAN configuration	33
5.3	Wireless(WiFi)	34
5.4	DHCP server	34
5.5	Dial-up Networking (DUN) over serial	34
6	IP Networking Features	35
6.1	Port-forwarding	35
6.2	DMZ	36
6.3	IP pass-through	37
6.4	Dynamic IP registration	38
6.5	IP Security (IPSEC)	38
6.6	Access Control List (ACL)	39
6.7	Password protection	39
7	Serial IP	41
8	GPS	42
8.1	GPS protocols	43
8.2	Odometer	43
8.3	Configuring the modem for GPS reporting	43
9	I/O Management	45
9.1	Digital Output control	45
9.2	Digital Input state query	45
9.3	Analog Input value query	46
10	Event Reporting	47
10.1	Events	47
10.2	Store and forward	47
10.3	Actions	48
10.4	Reports	48
11	Hardware Installation	49
11.1	Mounting the BT-5x00v2 series modem	49
11.2	Mounting the BT-6000 series modem	49
11.3	Cellular antenna	49
11.4	Ethernet cable	51

11.5	USB cable	51
11.6	Serial cable.....	51
11.7	Power source	51
12	Appendixes.....	53
12.1	BlueVue Device Manager Troubleshooting.....	53
12.2	Activation Troubleshooting	57
12.3	Troubleshooting	60
12.4	Firmware Upgrades	63
12.5	Sending AT Commands.....	65
12.6	Dial-Up Networking in Windows	67
12.7	Warranty.....	69
12.8	Customer Support	69

Figures

Figure 1 - Router mode	11
Figure 2 - IP pass-through mode	11
Figure 3 – Serial connector (looking at back of modem)	23
Figure 4 – The different ways to connect to a modem.....	25
Figure 5 – Connecting to a remote modem.....	26
Figure 6 – Confirming the success of activation	30
Figure 7 – Editing the account information	31
Figure 8 – Testing the connection.....	32
Figure 9 – Default LAN IP configuration.....	33
Figure 10 – Sample modem configuration for communicating with a device that has the IP 10.127.0.17	34
Figure 11 – Port-forwarding entries.....	36
Figure 12 – Enabling DMZ	36
Figure 13 – Enabling IP passthrough.....	37
Figure 14 – Enabling Dynamic IP Registration	38
Figure 15 – Enabling password protection	39
Figure 16 – Serial IP.....	41
Figure 17 – GPS configuration screen	42
Figure 18 – Modem with good signal strength	57
Figure 19 – Phone number being displayed on the Modem Diagnostic screen after activation	57
Figure 20 – WAN IP being displayed after the modem successfully connects to the cellular network	58
Figure 21 – Upgrading the firmware.....	64
Figure 22 – Creating a new connection in Windows XP	67

Tables

Table 1 – Modem features.....	12
Table 2 – General specifications	13
Table 3 - 4-pin Molex connector (BT-5xx0v2).....	17
Table 4 - 4-pin Molex connector (BT-6x00).....	17
Table 5 - 4-pin screw terminal (BT-6xx1)	18
Table 6 – DC 2.5mm Barrel adapter (BT-6000).....	18
Table 7 – Power consumption	Error! Bookmark not defined.
Table 8 – LEDs	22
Table 9 – Reset button functions.....	23
Table 10 – DHCP IP assignment	33
Table 11 – NMEA messages information	43
Table 12 – dB loss per 100 feet of cable type	49

1 Product Overview

1.1 Introduction

The BlueTree 5000v2 and 6000 series modems are rugged cellular modems built to provide simple and reliable communication over a CDMA or GSM cellular data networks. They are typically used in applications such as Public Safety, Transportation, Vehicle Tracking, Telemetry, SCADA, Remote / Temporary Offices, Landline Replacement, and WAN backup / Business Continuity.

The models covered by this document are:

Type	CDMA EvDO.A	GSM EDGE	GSM HSPA	LTE
MobilityPro™ Gateway				
<i>Standalone GPS</i>	BT-5600v2		BT-5800v2	BT-5700v2
<i>Standalone GPS with Wi-Fi</i>	BT-5630v2		BT-5830v2	BT-5730v2
IndustrialPro™ Gateway				
<i>4-pin power connector</i>	BT-6600		BT-6800	BT-6700
<i>Screw-block power connector</i>	BT-6601	BT-6401	BT-6801	BT-6701
<i>PoE power input</i>	BT-6601EB	BT-6401EB	BT-6801EB	BT-6701EB
<i>Ethernet Switch</i>	BT-6621	BT-6421	BT-6821	BT-6721

The modem supports two operational modes: router mode, and IP pass-through mode.

1.1.1 Router mode

In Router mode, which is the default mode, the modem manages local and wireless connections independently, and is capable of routing data packets back and forth between the two.

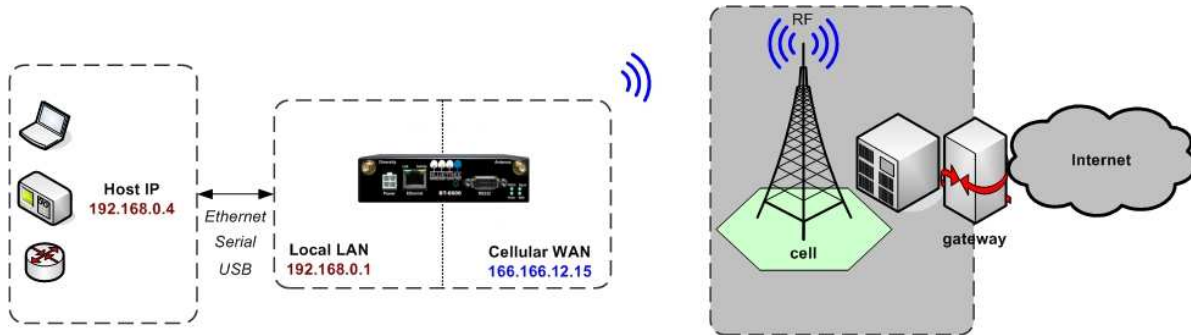

Figure 1 - Router mode

The modem manages two connections at the same time, thus acting as a gateway/router:

- **Cellular WAN connection:** This is the Wide Area Network connection to the cellular network/Internet. The modem can be configured to automatically and autonomously establish a packet data connection to the cellular carrier and acquire a WAN IP address.
- **LAN connection:** This is the local connection between the modem and any device attached to its Serial / Ethernet / USB ports. In the case of Ethernet and USB, the modem acts as a DHCP server and assigns a private LAN IP address to the attached device.

The modem then routes packets back and forth between its WAN and LAN connections, and in turn allows the locally attached device to communicate with computers or devices at a remote location.

1.1.2 IP pass-through mode

In IP pass-through mode, the modem assigns its WAN IP address directly to the attached host, thus becoming a fully transparent actor in the communication process. The modem remains reachable through its reserved TCP and UDP ports so that remote administration and configuration is still possible. Note that this mode allows only one IP address to be assigned to the first connected device via DHCP (This configuration is not recommended for BT-6x21).

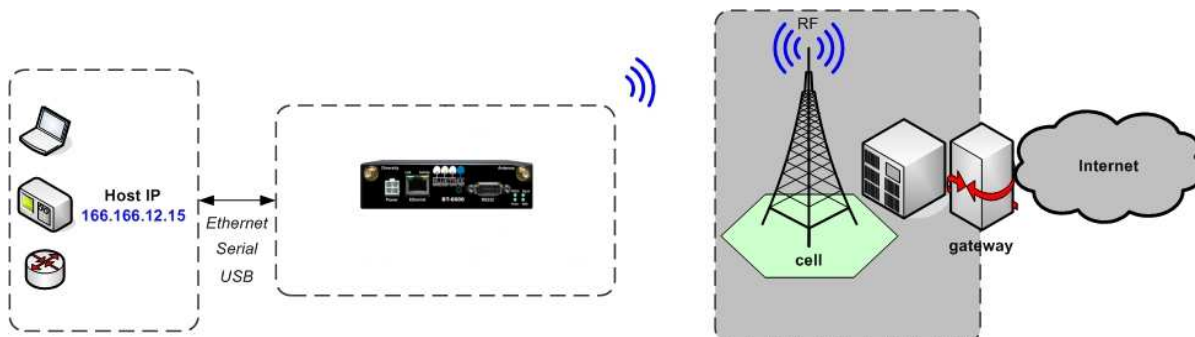

Figure 2 - IP pass-through mode

1.2 Modem features

Table 1 – Modem features

3 different data connection interfaces	Serial/RS-232/COM, Ethernet, and USB
Ethernet switch	<i>Available on the BT-6x21 models only.</i> These models have an embedded 5-port Ethernet switch.
Power-over-Ethernet	Models ending in EB (BT-6x01EB) are models with built in power sourcing. Power-over-Ethernet compatible devices can be powered simply by connecting it to the modem's Ethernet port.
Autonomous & persistent connection management	Fully integrated TCP/IP protocols allow the modem to connect autonomously to the packet network (Internet). This feature enables capabilities such as: in-call diagnostic, Serial-IP, stand-alone GPS, remote configuration and remote firmware upgrades.
DHCP server	The modem's DHCP server allows easy administration and setup of the local network by automating IP address assignment
IP pass-through	The modem can assign its WAN IP address to the attached host, thus disabling the DHCP server's Network Address Translation. Even when performing pass-through, the modem remains reachable for remote administration through its reserved TCP ports.
IP security	The modem can be configured with up to 10 IPSEC tunnels for increased security in communications.
In-call diagnostic	The user can get modem status information while in a data call, without interrupting the data session
Serial IP	The modem can provide a reliable means of communication with serial-only legacy devices. It can encapsulate data coming from the serial port into a TCP or UDP packet and send it to a remote server on the packet network or Internet. It can decapsulate IP packets coming from the network and send raw data to the serial port.
Remote configuration	The modem can be remotely configured or diagnosed using BlueVue Device Manager or a terminal session
Remote firmware upgrade	The modem's firmware can be remotely upgraded using BlueVue Device Manager software
Password protection	The modem's configuration can be protected from tampering by requesting the user to enter a password before the existing modem configuration can be viewed or modified
Integrated GPS receiver	BT-5000v2 models include a GPS receiver for Automatic Vehicle Location (AVL). The modem can report this positioning data locally to any of the local data interfaces (serial, Ethernet, or Ethernet-over-USB), and/or remotely to a predefined server (see stand-alone).
Standalone GPS	BT-5000v2 modems can be used for remote asset tracking by sending GPS data to a remote server without the need for a client application or computer connected to the modem.
Store and forward	If a unit loses its connection to the cellular network, the event data being collected from I/O, GPS and other sources will be stored in memory and automatically forwarded when the connection is reestablished. This is available when using TCP (with or without BEP ACK) or UDP (with BEP ACK

	only).
Inputs and outputs	<p>Sensors can be connected to the I/O ports of the modem. Depending on models, the modem is capable of monitoring up to four digital inputs for any change in state, and up to three analog inputs for changes in gradient data sources. The modem also has up to three digital outputs that can be used to remotely trigger relays.</p> <p>The inputs and outputs can be used with the event reporting protocol to allow automatic reports and triggers.</p>
Event reporting	<p>The modem can send a report to up to 10 destinations when a user-defined event is triggered. Up to 30 events can be defined based on I/O signals, GPS data, RF status. The modem has an embedded event reporting protocol that automatically formats the messages reported to the remote server.</p>
Mobile Originated Management	<p>The modem can connect to a remote server and perform management actions (firmware upgrade, configuration changes ...). This feature uses Event Reporting.</p>
Partner apps	<p>The modem can host partner applications used for example to report cellular traffic usage, vehicle diagnostics, alarms, ...</p>

1.3 Specifications

1.3.1 General specifications

Table 2 – General specifications

Wireless interfaces	<p>CDMA EvDO.A models Dual-band CDMA2000 EVDO Rev. A (with diversity) Backward compatible with 1xRTT and IS95</p> <p>GSM EDGE Models Quad-band 850/900/1800/1900 GSM Backward compatible with Quad-band GPRS/UMTS</p> <p>GSM HSPA Models Quad-band 800/850/1900/2100 MHz WCDMA (with diversity) HSDPA/HSUPA/HSPA Backward compatible with GPRS/EDGE/UMTS</p>
Peak data rates	<p>Download: CDMA – 3.1Mbps / EDGE – 384 kbps / HSPA - 7 Mbps Upload: CDMA - 1.8 Mbps / EDGE – 120 kbps / HSPA - 5.76 Mbps</p>
Serial interface	1x RS-232 Serial DB9 115200bps
USB interface	<p>BT-5xxxv2 series: 1x USB 2.0 type B BT-6xxx series: 1x USB 2.0 mini B</p>
LED indicators	Power, WAN, Signal, RS232, GPS, Ethernet Link & Activity
Dimensions	<p>BT-6x0x: 120 x 96 x 32 mm (4.7 x 3.77 x 1.25"), 453g (1.0 lb) BT-6x21: 120 x 96 x 51 mm (4.7 x 3.77 x 2.00"), 500g (1.1 lb) BT-5xx0v2: 159 x 127 x 53 mm (6.26 x 5.00 x 2.09"), 500g (1.1 lb)</p>
Power Input	8 - 30 VDC (12 VDC nominal), Power over Ethernet on BT-6x01EB

Power consumption	See Table 6
Environmental	<p>BT-5000v2 series Operating Temp: -40 to +85°C (-40 to 185°F) Shock & Vibration: MIL-STD 810F/202G Humidity: 5 to 95% non-condensing</p> <p>BT-6000 series Operating Temp: -40 to +85°C (-40 to 185°F) Shock & Vibration: IEC 60068-2-1/2/6/27/30, DNV 2.4 3.7/8/9, MIL-STD 810F/202G Humidity: 5 to 95% non-condensing</p>
Certification	Hazardous Locations - Class I, Div. 2, Groups A,B,C,D, UL1604 Electrical Safety - UL508/CSA22.2/14 (CUL) EMC- FCC, part 15 and Industry Canada, ICES-003 PTCRB (GSM), CE, R&TTE

1.3.2 Mechanical specifications BT-5xx0v2

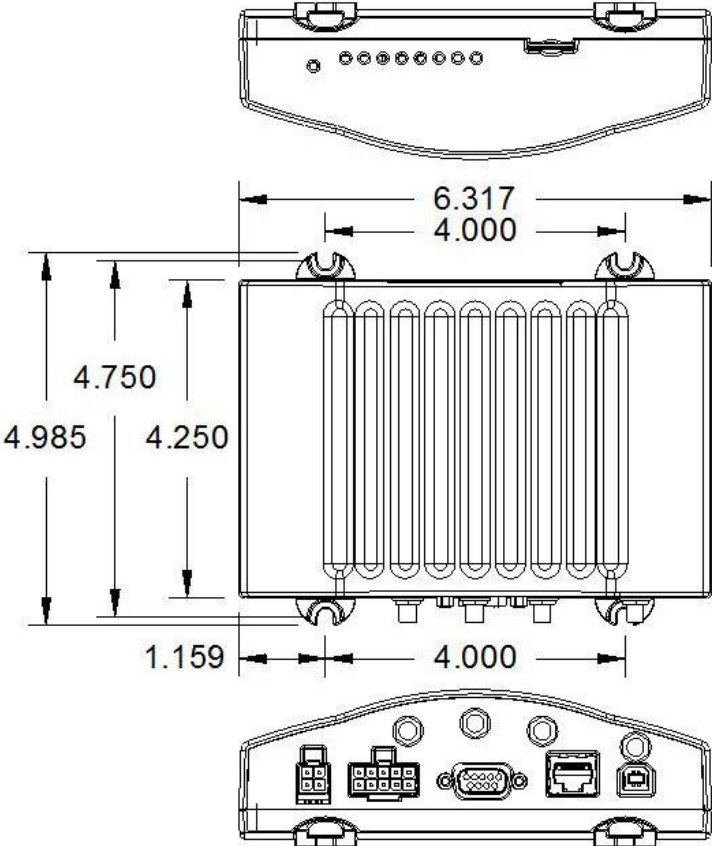

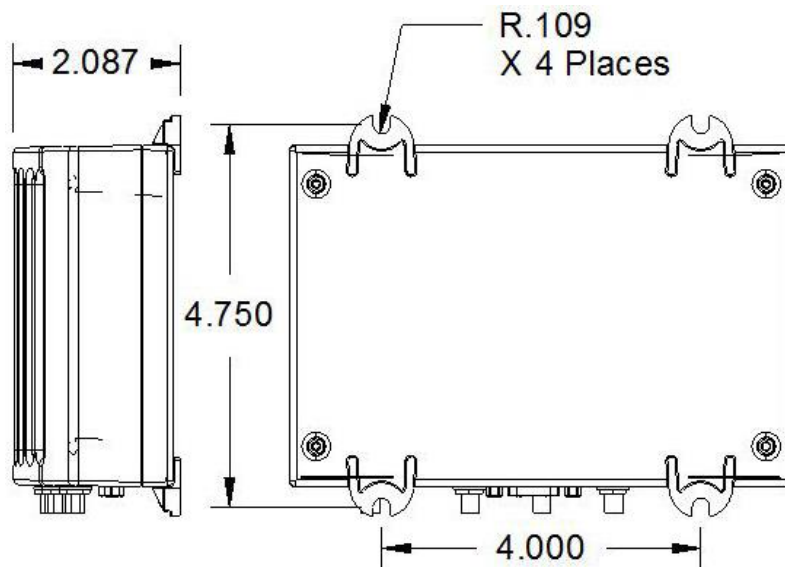

1.3.3 Mechanical specifications BT-6000

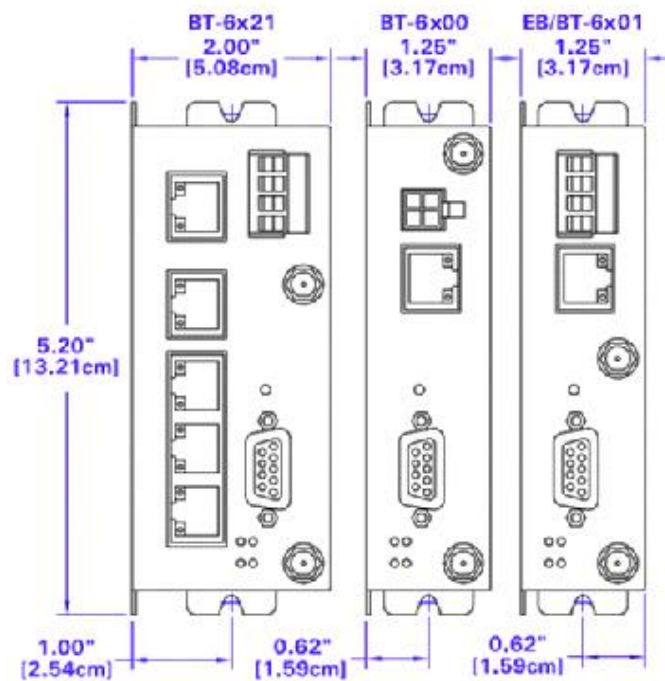

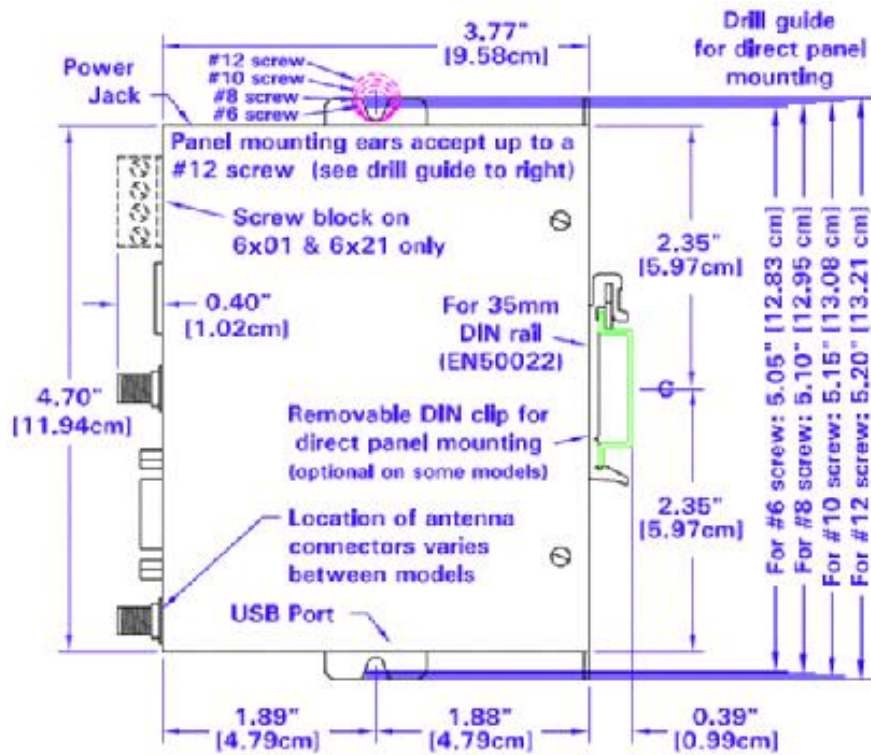

1.3.4 Power specifications and consumption

Power is supplied to the modem via:

- 4-pin Molex connector for the BT-6x00 and BT-5x00v2 models
- 4-pin screw terminal for the BT-6x01, BT-6x01EB and BT-6x21 models
- DC 2.5mm barrel plug for all BT-6000 models
- Power over Ethernet for all BT-6x01EB models

1.3.4.1 4-pin Molex Connector (BT-5xxv2)

Power is supplied to the modem via the 4-pin Molex connector on the rear panel for BT-5x00 v2 models. The pins are described as follows:

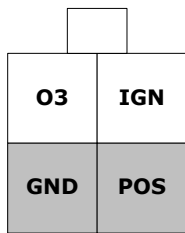

Power connector
(facing modem)

Table 3 - 4-pin Molex connector (BT-5000v2)

Pin	Name	Description
1	GND	Ground
2	POS	Power supply input (8 to 30 VDC)
3	IGN	Ignition sense input (switches modem on or off)
4	O3	Digital Output 3

1.3.4.2 4-pin Molex Connector (BT-6x00)

Power is supplied to the modem via the 4-pin Molex connector on the front panel for the BT-6x00 models. The pins are described as follows:

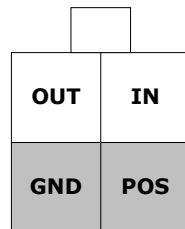

Power connector
(facing modem)

Table 4 - 4-pin Molex connector (BT-6x00)

Pin	Name	Description
1	GND	Ground
2	POS	Power supply input (8 to 30 VDC)
3	IN	Digital and analog input
4	OUT	Digital Output

1.3.4.3 4-pin Screw Terminal (BT-6xx1)

Power is supplied to the modem via the 4-pin Screw Terminal on the front panel for the BT-6xx1 models. The pins are described as follows:



Power connector
(facing front)

Table 5 - 4-pin screw terminal (BT-6xx1)

Pin	Name	Description
1	GND	Ground
2	PWR+	Power supply input (8 to 30 VDC)
3	OUT	Digital output
4	IN	Digital and analog input

1.3.4.4 DC 2.5mm Barrel Adapter

Power is supplied to the modem via the barrel adapter on the left side of all BT-6000 series modems. The contacts are described as follows:



Power connector
(facing left side)

Table 6 – DC 2.5mm Barrel adapter (BT-6000)

Pin	Name	Description
Sleeve	GND	Ground
Tip	PWR+	Power supply input (8 to 30 VDC)

WARNING:

DC 2.5mm Barrel Adapter shall not be used in hazardous locations.

1.3.4.5 Power specification





Power input to the modem is protected against reverse polarity and over-voltage. The modem's power consumption is as follows:

Typical power consumption (Watts)			
Model	Standby	Transmitting minimum	Transmitting maximum
BT-5600v2	1.5	2.1	3.0
BT-5800v2	1.5	2.7	5.1
BT-6401	1.4	2.0	5.0
BT-6421	2.7	3.4	6.4
BT-660x	1.4	2.0	2.9
BT-6621	3.0	3.6	4.5
BT-680x	1.4	2.6	5.0
BT-6821	3.0	4.2	6.6
BT-670x	1.6	2.6	6.9
BT-6721	3.3	4.3	8.7

Wiring instructions are provided in the [Hardware Installation](#) section.





All modems are equipped with protection for reversed polarity and power surges over 33 volts. The modems are equipped with an internal 3 Amp fuse. When using the 4 pin Molex connector / power accessory cable supplied by BlueTree Wireless, an extra 2 Amp fuse is also included (5600v2, 5800v2).

1.3.5 Modem views (Red Lion labels)

<p><i>Standalone GPS With Wi-Fi(5x30 only)</i></p>	 <p style="text-align: center;">BT-5xx0v2</p>	<ul style="list-style-type: none"> • BT-5600v2 • BT-5800v2 • BT-5700v2 • BT-5730v2 • BT-5630v2 • BT-5830v2
<p><i>4-pin power connector</i></p>	 <p style="text-align: center;">BT-6x00</p>	<ul style="list-style-type: none"> • BT-6600 • BT-6700 • BT-6800
<p><i>Screw-block power connector</i></p>	 <p style="text-align: center;">BT-6x01</p>	<ul style="list-style-type: none"> • BT-6401* • BT-6601 • BT-6701 • BT-6801
<p><i>Screw-block power connector & PoE power input</i></p>	 <p style="text-align: center;">BT-6x01EB</p>	<ul style="list-style-type: none"> • BT-6401EB* • BT-6601EB • BT-6701EB • BT-6801EB
<p><i>Ethernet Switch</i></p>	 <p style="text-align: center;">BT-6x21</p>	<ul style="list-style-type: none"> • BT-6421* • BT-6621 • BT-6721 • BT-6821

• The BT-64xx series modems are not equipped with a diversity antenna connector

1.3.6 Modem views (BlueTree labels)

<p><i>Standalone GPS</i></p>	 <p>BT-5x00v2</p>	<ul style="list-style-type: none"> • BT-5600v2 • BT-5800v2
<p><i>4-pin power connector</i></p>	 <p>BT-6x00</p>	<ul style="list-style-type: none"> • BT-6600 • BT-6800
<p><i>Screw-block power connector</i></p>	 <p>BT-6601</p>	<ul style="list-style-type: none"> • BT-6401* • BT-6601 • BT-6801
<p><i>Screw-block power connector & PoE power input</i></p>	 <p>BT-6x01</p>	<ul style="list-style-type: none"> • BT-6401EB* • BT-6601EB • BT-6801EB
<p><i>Ethernet Switch</i></p>	 <p>BT-6x21</p>	<ul style="list-style-type: none"> • BT-6421* • BT-6621 • BT-6821

• The BT-64xx series modems are not equipped with a diversity antenna connector

1.3.7 Indicators Lights (LED)

Table 7 – LEDs

LED	Status	Corresponding State
Power	OFF	Modem is powered off
	ON	Modem is powered on
	FLASH	Firmware error
Signal	OFF	No signal available or signal strength is below -100 dBm
	ON	Excellent signal strength = greater than -69 dBm
	FLASH	Fast: Every 300ms = -79 to -70 dBm
		Medium: Every 600ms = -89 to -80 dBm
Slow: Every 1200ms = -99 to -90 dBm		
WAN	OFF	Cellular connection is not established
	ON	Cellular connection is established - no network data activity
	FLASH	Cellular connection is established - with network data activity
RS232	OFF	Serial connection is not established
	ON	Serial connection is established - no data activity with host
	FLASH	Serial connection is established - with data activity with host
GPS (BT-5x00v2)	OFF	No position fix available
	ON	Position fix available

1.3.8 Data Interface Specifications: Serial, Ethernet & USB

1.3.8.1 Ethernet Port

The modem's 10/100Mbps Ethernet port is compliant with the EIA-568 standard. The modem's ports are autosensing so they can be used with either a straight or crossover RJ45 cable to connect to host ports.

The BT-6x21 features a 5-port Ethernet switch allowing connectivity to multiple local devices.

1.3.8.2 USB Device Port

This is a USB 2.0 Device interface on a Type B (BT-5x00v2) or Mini B (BT-6xxx) connector. It offers Ethernet-over-USB functionality using the RNDIS driver for Windows XP and Windows Vista Operating systems only. The BlueTree RNDIS driver must be installed before the USB interface can be used. The driver is automatically installed with BlueTree Device Manager or you can obtain the driver at www.redlion.net and install it manually.

1.3.8.3 Serial Port (DB9)

The modem's serial port is an RS232 DCE, compliant with EIA-232 standard. The connector used is DB9 female and is shown in the illustration below.

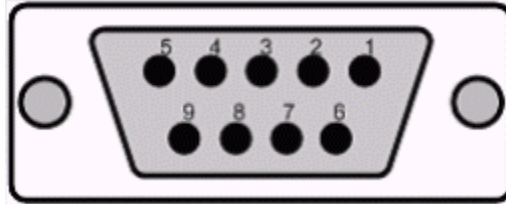

Figure 3 – Serial connector (looking at back of modem)

For further serial wiring information, refer to the [Hardware Installation](#) section.

1.3.9 RESET button functions

Table 8 – Reset button functions

Mode	Pattern	Description
Hard reset	Press and hold for less than 3 seconds	Standard reboot
Factory restore	Press and hold between 3 and 10 seconds RS232 LED flashes quickly	Overwrites user configuration with the default factory settings
FW upgrade	Press and hold between 10 and 15 seconds WAN LED flashes quickly	Puts the modem in advanced firmware upgrade mode by restarting the modem and running the bootloader only. Do not use this mode unless instructed to by BlueTree Technical Support.
USB pass-through	Press and hold for longer than 15 seconds Signal LED flashes quickly	Puts the modem in main pass-through mode to the RF module, allowing CCT provisioning and PST support. Do not use this mode unless instructed to by BlueTree Technical Support.

2 BlueVue Device Manager (BVDM)

The BlueTree BT-5000v2 and BT-6000 series modems can be configured using BlueVue Device Manager version 1.76 or later. This software application is available as a free download at www.redlion.net. Later sections of this guide will refer to configuration options in this software. For more in-depth information on using BVDM, refer to the *BlueVue Device Manager User's Guide*. It can be accessed from within BVDM itself by clicking the Help button, or downloaded separately at www.redlion.net.

BVDM is a Graphical User Interface for modem configuration and administration that allows the user to:

- Activate the modem (program account information) for use on the cellular network
- Register the modem on the cellular network (WAN Setup)
- Configure operation parameters (such as LAN setup or GPS)
- Monitor diagnostic and status information
- Perform firmware upgrades to the modem

2.1 Connecting to the modem

Should you run into any issues connecting to the modem, refer to the [BlueVue Device Manager Troubleshooting](#) appendix.

Click on **Tools > Settings > Connection tab** to select the interface your PC will use to connect to the modem.

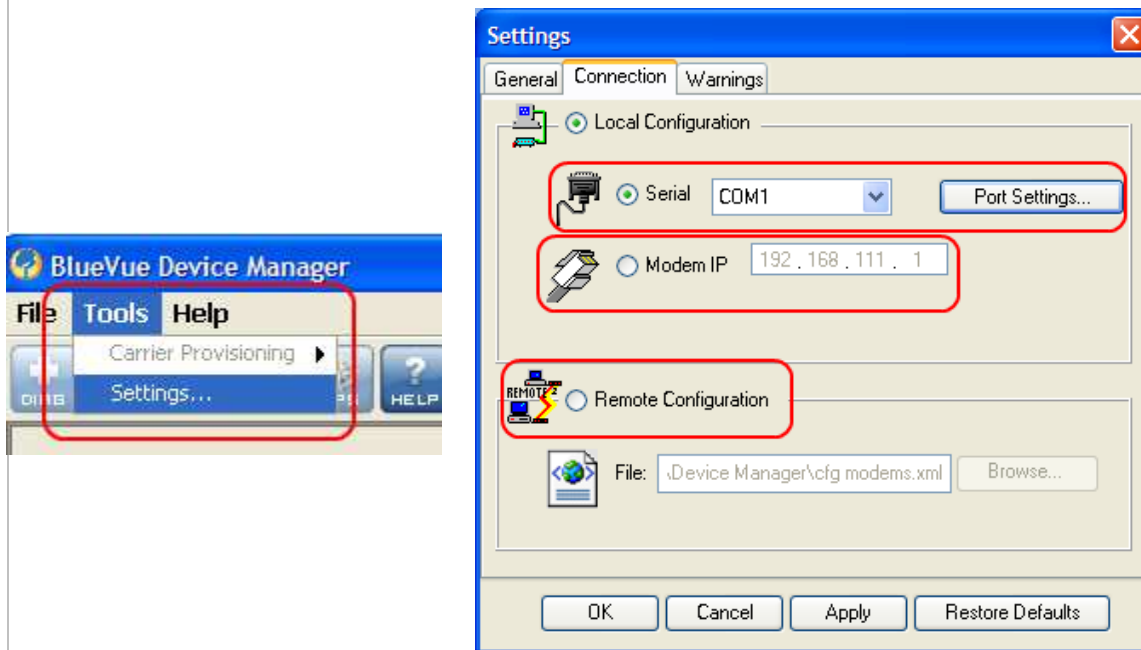

Figure 4 – The different ways to connect to a modem

2.1.1 Using a serial cable:

- 1) Select **Serial**
- 2) Select the **COM** port in the dropdown list, then click OK

2.1.2 Using an Ethernet or USB cable:

- 3) Select **Modem IP**
- 4) **Enter the appropriate modem IP** then click **OK**. By default, the DHCP-assigned IPs will be **192.168.0.1** for **Ethernet** and **192.168.111.1** for **USB**. If using USB, the BlueTree RNDIS driver must be installed as explained in the [Data Interface Specifications](#) section.

2.1.3 Connecting to a remote modem:

- 5) Select **Remote Configuration** and click OK. A new panel will open to the left of BlueVue Device Manager.
- 6) Right-click **Available Modems** in the panel
- 7) Click **Add...**
- 8) **Enter the modem's information**, then click OK. The description is optional.