



Chipsmall Limited consists of a professional team with an average of over 10 year of expertise in the distribution of electronic components. Based in Hongkong, we have already established firm and mutual-benefit business relationships with customers from,Europe,America and south Asia,supplying obsolete and hard-to-find components to meet their specific needs.

With the principle of “Quality Parts,Customers Priority,Honest Operation,and Considerate Service”,our business mainly focus on the distribution of electronic components. Line cards we deal with include Microchip,ALPS,ROHM,Xilinx,Pulse,ON,Everlight and Freescale. Main products comprise IC,Modules,Potentiometer,IC Socket,Relay,Connector.Our parts cover such applications as commercial,industrial, and automotives areas.

We are looking forward to setting up business relationship with you and hope to provide you with the best service and solution. Let us make a better world for our industry!



Contact us

Tel: +86-755-8981 8866 Fax: +86-755-8427 6832

Email & Skype: info@chipsmall.com Web: www.chipsmall.com

Address: A1208, Overseas Decoration Building, #122 Zhenhua RD., Futian, Shenzhen, China



NEW PRODUCTS*

MICRO-SCALE TEST KIT

Micro-scale Test Kit accessories are designed to attach to industry standard multimeter test probes or prods. These accessories allow convenient and safe testing on breadboards or printed circuit boards.

KT-MS002 includes:

- (2) 48" test leads with right angle shrouded banana plug to test prod
- (2) Alligator Clip Micro-scale test lead attachments (one red, one black)
- (2) Micro-plunger Clip Micro-scale test lead attachments (one red, one black)
- (2) Breadboard Pin Micro-scale test lead attachments (one red, one black)
- (2) Needle Pin Micro-scale test lead attachments (one red, one black)
- (2) Pin Socket Micro-scale test lead attachments (one red, one black)
- (2) Magnetic Probe Micro-scale test lead attachments (one red, one black)
- (1) Battery Current Probe Micro-scale test lead attachment
- (2) Nano-plunger Clip Micro-scale test lead attachments (one red, one black)
- (1) Carrying pouch

KT-MS001 INCLUDES:

- All of the above accessories without the 48" test leads



ALLIGATOR CLIP ATTACHMENT

- Used to grip larger terminals, rails and wires
- Mueller BU-30 Clip
- Insulator included to reduce the risk of shorting to other components
- Rated for 5 amps of current



MAGNETIC PROBE ATTACHMENT

- Used to attach to any metal surface
- Can be used to hold one lead to a cabinet ground, freeing both hands to probe other components.
- Effortless connection to a dry-cell battery



BREADBOARD PIN ATTACHMENT

- Used for hands free probing of breadboards
- Fits standard .025 inch square holes
- 50 micron gold plated pin ensures long life and accurate measurements
- Insulated handle for effortless insertion



NANO-PLUNGER CLIP ATTACHMENT

- Used to grip fine-pitch leads on circuit boards
- Ideal for SMD pins with pitches as low as 1mm
- Gold plated for low resistance connections



BATTERY CURRENT PROBE ATTACHMENT

- Used to measure the current in a dry cell battery compartment
- Easily inserts between the battery and the spring contact



NEEDLE PIN ATTACHMENT

- Used to pierce the conformal coating on circuit boards
- Has low profile holder to reach tight locations



PIN SOCKET ATTACHMENT

- Used to connect to .080" male pins
- A great way to test D-Sub connectors
- High quality gold plated contact



MICRO-PLUNGER CLIP ATTACHMENT

- Used to grip the leads on through-hole components
- Small enough to test individual IC leads
- Durable nylon construction

CARRYING POUCH

- Used to store and carry all of the Micro-scale Accessories
- Fits comfortably in a shirt or pants pocket



Mueller clips are the industry standard. Our designs reflect 95 years of innovation and improvement. Mueller clips assure teeth that bite, springs that hold, plating that lasts and insulators that protect.

Color Key

0=Black	4=Yellow	6=Blue
2=Red	5=Green	9=White

Miniature Alligator

Model # BU-30/BU-30C

Solder or crimp connection
Jaw opens 0.188" (4.8 mm) max

Material: nickel-plated steel (BU-30) or solid copper (BU-30C)

Length: 1.1" (27.78mm)

Federal Spec: CID AA59466-001 (BU-30C)

Rating: 5 Amps

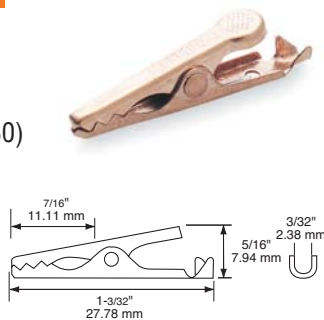

Miniature Alligator with Barrel

Model # BU-30BL

Solder or crimp connection
Jaw opens 0.188" (4.8 mm) max

Material: nickel-plated steel

Length: 1.25" (31.75mm)

Rating: 5 Amps

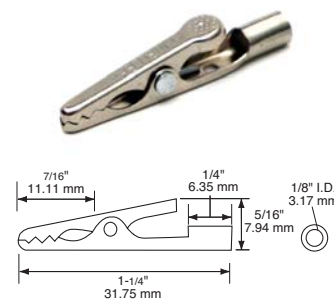

Insulator for Miniature Alligator

Model # BU-32-*

Protective flexible vinyl insulator for 30, 30C

Material: PVC

Length: 1.63" (41.28mm)

***Std. Colors:** -0 Black, -2 Red, -4 Yellow, -5 Green, -6 Blue, -9 White

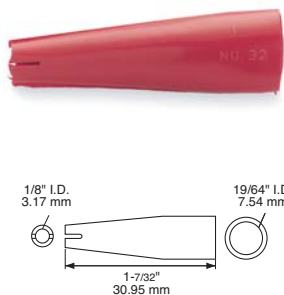

Miniature Alligator with Threaded Barrel

Model # BU-30TBO

6-32 threaded steel barrel connection
Jaw opens 0.188" (4.8 mm) max

Material: nickel-plated steel

Length: 1.5" (38.75mm)

Rating: 5 Amps



Insulator for Mini Alligator Barrel/Threaded Barrel

Model # BU-31-*

Protective flexible vinyl insulator for 30BL, 30TBO

Material: PVC

Length: 1.63" (41.28mm)

***Std. Colors:** -0 Black, -2 Red, -4 Yellow, -5 Green, -6 Blue, -9 White

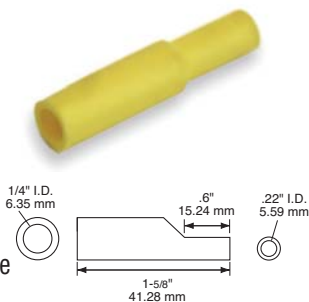

Micro-Alligator

Model # BU-34/BU-34C

Solder or crimp connection

Jaw opens 0.22" (5.6 mm) max

Material: nickel-plated steel (BU-34) or solid copper (BU-34C)

Length: 1.09" (27.78mm)

Rating: 5 Amps

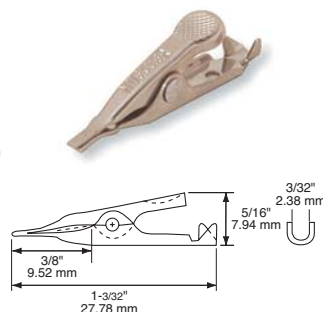

Insulator for Micro Alligator

Model # BU-36-*

Protective flexible vinyl insulator for 34, 34C

Material: PVC

Length: 1.22" (30.95mm)

***Std. Colors:** -0 Black, -2 Red, -4 Yellow, -5 Green, -6 Blue, -9 White



Alligator Clip with Barrel

Model # BU-60/BU-60C/BU-60X

Compatible with all shrouded, unshrouded, or retractable 0.16" (4mm) banana plugs

Solder or crimp connection

Jaw opens 0.31" (7.9 mm) max

Material: nickel-plated steel (BU-60), solid copper (BU-60C), solid stainless steel (BU-60X)

Length: 1.97" (50mm)

Rating: 10 Amps

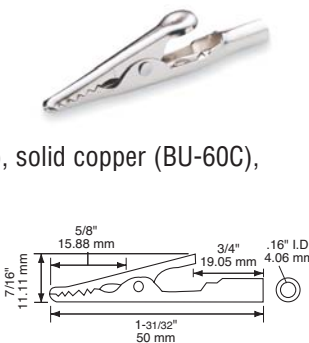

Alligator Clip with Screw

Model # BU-60S/BU-60CS

Compatible with all shrouded, unshrouded, or retractable 0.16" (4mm) banana plugs

6-40 screw connection

Jaw opens 0.31" (7.9 mm) max

Material: nickel-plated steel (BU-60S) or solid copper (BU-60CS)

Length: 1.97" (50mm)

Federal Spec: CID AA59466-002 (BU-60CS)

Rating: 10 Amps

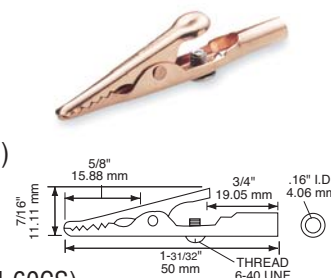

Phone Tip Alligator Clip

Model # BU-60PR2

Accepts standard phone tip or test prod tip

Jaw opens 0.31" (7.9 mm) max

Material: nickel-plated steel

Length: 1.97" (50mm)

Rating: 10 Amps

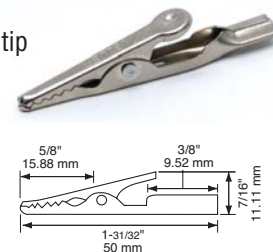

Threaded Barrel Alligator Clip

Model # BU-60TBO

8-32 threaded barrel connection

Jaw opens 0.31" (7.9 mm) max

Material: nickel-plated steel

Length: 2.13" (53.97mm)

Rating: 10 Amps



Alligator Clip

Model # BU-60U

Solder or crimp connection

Jaw opens 0.31" (7.9 mm) max

Material: nickel-plated steel

Length: 1.97" (50mm)

Rating: 10 Amps



Alligator Clip with Cage Spring Barrel

Model # BU-61

Cage spring connection accepts standard prod needle (0.080 dia.)

Jaw opens 0.31" (7.9 mm) max

Material: nickel-plated steel clip, nickel-plated brass insert, gold plated beryllium copper cage spring

Length: 2.03" (51.59mm)

Rating: 10 Amps

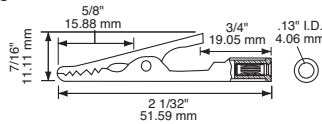

Insulator for Alligator Clips

Model # BU-62-*

Protective flexible vinyl insulator for 60, 60C, 60CS, 60PR2, 60S, 60TBO, 60U, 60X and 61

Material: PVC

Length: 2.03" (51.59mm)

***Std. Colors:** -0 Black, -2 Red, -4 Yellow, -5 Green, -6 Blue, -9 White

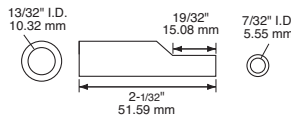

Alligator Clip with Acetate Handle

Model # BU-60H-*

Compatible with all shrouded, unshrouded, or retractable 0.16" (4mm) banana plugs

Jaw opens 0.31" (7.9 mm) max

Material: nickel-plated steel clip; tenite acetate insulated handle

Length: 2.23" (56.75mm)

***Std. Colors:** -0 Black, -2 Red, -4 Yellow, -5 Green, -6 Blue, -9 White

Rating: 10 Amps

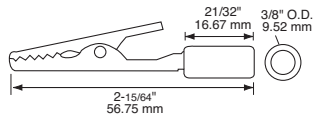

Alligator Clip with Acetate Handle and Screw

Model # BU-60HS-*/BU-60CHS-*

Compatible with all shrouded, unshrouded, or retractable 0.16" (4mm) banana plugs

Jaw opens 0.31" (7.9 mm) max

Material: nickel-plated steel (BU-60HS-*) or solid copper (BU-60CHS-*) clip; tenite acetate insulated handle

Length: 2.34" (59.53mm)

***Std. Colors:** -0 Black, -2 Red, -4 Yellow, -5 Green, -6 Blue, -9 White

Federal Spec: AA59466-003 (red), AA59466-016 (black), (BU-60CHS-*)

Rating: 10 Amps

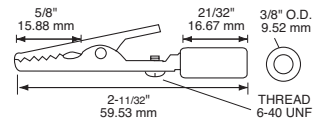

Phone Tip Alligator Clip with Acetate Handle

Model # BU-60HPR-*

Accepts standard phone tip or test prod tip

Material: nickel-plated steel clip; tenite acetate insulated handle

Length: 2.23" (56.75mm)

***Std. Colors:** -0 Black, -2 Red, -4 Yellow, -5 Green, -6 Blue, -9 White

Rating: 10 Amps

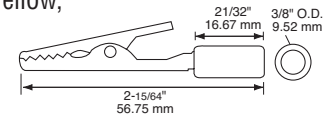

Insulated Alligator Clip

Model # BU-63-*/BU-63C-*

BU-63-* same as BU-60S and includes a skin-tight, two-piece, flexible insulator

BU-63C-* same as BU-60CS and includes a skin-tight, two piece, flexible insulator

Compatible with all shrouded, unshrouded, or retractable 0.16" (4mm) banana plugs

Material: nickel-plated steel (BU-63-*) or solid copper (BU-63C-*); PVC insulator

Length: 2.25" (57.15mm)

***Std. Colors:** -0 Black, -2 Red, -4 Yellow, -5 Green, -6 Blue, -9 White

Rating: 10 Amps

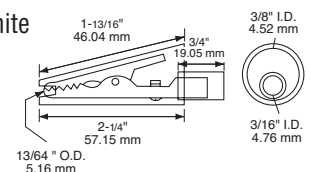

Alligator Clip

Model # BU-70/BU-70C

Solder or crimp connection
Jaw opens 0.313" (7.9 mm) max

Material: nickel-plated steel (BU-70) or solid copper (BU-70C)

Length: 1.69" (42.86mm)

Rating: 5 Amps (BU-70) or 10 Amps (BU-70C)

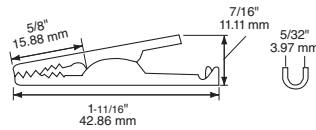

Alligator Clip with Screw

Model # BU-70S/BU-70CS

6-40 screw or crimp connection
Jaw opens 0.313" (7.9 mm) max

Material: nickel-plated steel (BU-70S) or solid copper (BU-70CS)

Length: 1.69" (42.86mm)

Federal Spec: AA59466-0017 (BU-70CS-*)

Rating: 5 Amps (BU-70S) or 10 Amps (BU-70CS)

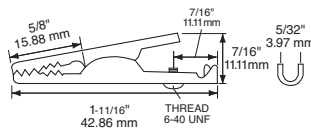

Insulator for Alligator Clip

Model # BU-72-*

Protective flexible vinyl insulator for 70, 70C, 70CS, 70S

Material: PVC

Length: 1.81" (46.04mm)

***Std. Colors:** -0 Black, -2 Red, -4 Yellow, -5 Green, -6 Blue, -9 White

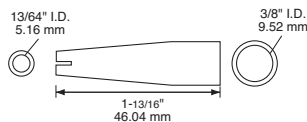

Crocodile Clip

Model # BU-85/BU-85C

Crimp or screw connection
Jaw opens 0.313" (7.9 mm) max

Nesting teeth provide solid contact along entire length of jaw

Material: zinc-plated steel (BU-85) or solid copper (BU-85C)

Length: 2.125" (53.97mm)

Federal Spec: AA59466-005 (BU-85C)

Rating: 5 Amps (BU-85) or 10 Amps (BU-85C)

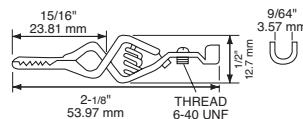

Insulator for Crocodile Clip

Model # BU-87-*

Protective flexible vinyl insulator for 85, 85C

Material: PVC

Length: 1.7" (43.26mm)

***Std. Colors:** -0 Black, -2 Red, -4 Yellow, -5 Green, -6 Blue, -9 White

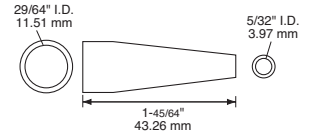

Small Safety Alligator Clip

Model # BU-651-*

Compatible with all shrouded, unshrouded, or retractable 0.16" (4mm) banana plugs

Jaw opens 0.27" (7 mm) max

Material: nickel-plated steel clip, glass-filled nylon housing

Length: 2.24" (57mm)

***Std. Colors:** -0 Black, -2 Red

Rating: 1000 V category II, 600V category III, 20 Amps, IEC 1010 Compliant



Small Safety Alligator Clip with Extended Banana Jack

Model # BU-652-*

Compatible with all shrouded, unshrouded, or retractable 0.16" (4mm) banana plugs

Jaw opens 0.27" (7 mm) max

Material: nickel-plated steel clip, glass-filled nylon housing

Length: 3.24" (82mm)

***Std. Colors:** -0 Black, -2 Red

Rating: 1000 V category II, 600V category III, 20 Amps, IEC 1010 Compliant



Large Safety Alligator Clip

Model # BU-65-*

Compatible with all shrouded, unshrouded, or retractable 0.16" (4mm) banana plugs

Jaw opens 0.75" (19 mm) max

Material: nickel-plated steel clip, glass-filled nylon housing

Length: 3.23" (82.04mm)

***Std. Colors:** -0 Black, -2 Red, -4 Yellow, -6 Blue

Rating: 1000 V, 30 Amps, IEC 1010 Compliant



Large Flanged Safety Alligator Clip

Model # BU-654-*

Compatible with all shrouded, unshrouded, or retractable 0.16" (4mm) banana plugs

Jaw opens 1.00" (26 mm) max

Material: nickel-plated steel clip, glass-filled nylon housing

Length: 3.19" (81mm)

***Std. Colors:** -0 Black, -2 Red

Rating: 1000 V category II, 600V category III, 20 Amps, IEC 1010 Compliant



Pee-Wee Clip

Model # BU-45/BU-45C

Screw or crimp connection

Jaw opens 0.31" (7.9 mm) max

Material: zinc-plated steel (BU-45) or solid copper (BU-45C)

Length: 1.53" (38.89mm)

Federal Spec: CID AA59466-006 (BU-45C)

Rating: 5 Amps (BU-45) or 10 Amps (BU-45C)

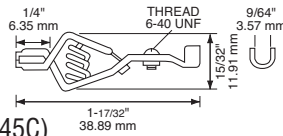

Insulator for Pee-Wee Clip

Model # BU-47-*

Protective flexible vinyl insulator for 45, 45C

Material: PVC

Length: 2.02" (51.2 mm)

***Std. Colors:** -0 Black, -2 Red, -4 Yellow, -5 Green, -6 Blue, -9 White

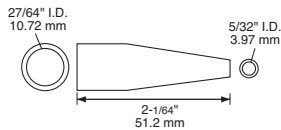

Economy Clip

Model # BU-55

Screw or crimp connection

Jaw opens 0.44" (11.1 mm) max

Material: zinc-plated steel

Length: 2" (50.8mm)

Rating: 10 Amps

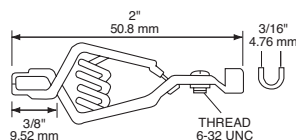

Insulator

Model # BU-74-*

Protective flexible vinyl insulator for 55

Accepts 0.27" (7 mm) ignition wire

Material: PVC

Length: 2.875" (73mm)

***Std. Colors:** -0 Black, -2 Red, -4 Yellow, -5 Green, -6 Blue, -9 White

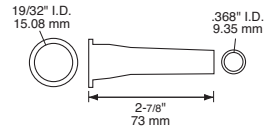

Automotive Analyzer Clip

Model # BU-48B/BU-48C

Screw or crimp connection

Jaw opens 0.5" (12.7 mm) max

Teeth mesh on three sides of the jaw

Material: zinc-plated steel (BU-48B) or solid copper (BU-48C)

Length: 2" (50.8mm)

Federal Spec: CID AA59466-007 (BU-48C)

Rating: 10 Amps (BU-48B) or 20 Amps (BU-48C)

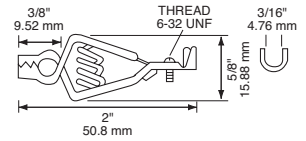

Automotive Analyzer Clip

Model # BU-48B2E

Screw or double crimp connection

Jaw opens 0.5" (12.7 mm) max

Material: zinc-plated steel

Length: 2" (50.8mm)

Rating: 10 Amps

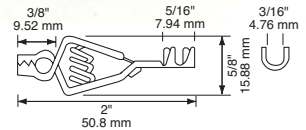

Meter Testing Clip With Needle

Model # BU-50C

Solid copper clip with beryllium copper piercing needle in the top jaw

Jaw opens 0.5" (12.7 mm) max

Material: Solid copper

Length: 2.28" (57.12mm)

Federal Spec: CID AA59466-013

Rating: 20 Amps

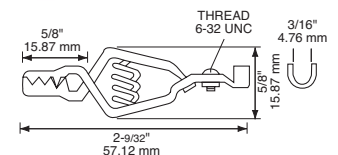

Meter Testing Clip

Model # BU-51C

Same as BU-50C except without insulation piercing needle

Jaw opens 0.5" (12.7 mm) max

Material: Solid copper

Length: 2.28" (57.12mm)

Rating: 20 Amps

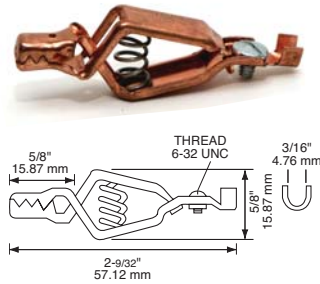

Insulator for Automotive Analyzer Clip

Model # BU-49-*

Protective flexible vinyl insulator for 48B, 48B2E, 48C, 50C, 51C, 55, 95

Material: PVC

Length: 2.56" (65.09mm)

***Std. Colors:** -0 Black, -2 Red, -4 Yellow, -5 Green, -6 Blue, -9 White

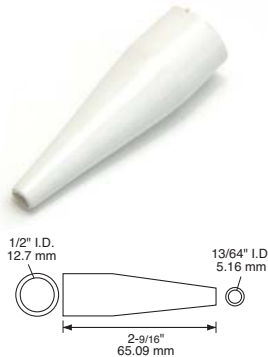

General Purpose Clip

Model # BU-27/BU-27C

Crimp or screw connection; jaw opens 0.625" (16 mm) max

Material: zinc-plated steel (BU-27) or solid copper (BU-27C); *Spring:* steel

Length: 2.44" (61.9mm)

Federal Spec: CID AA59466-008 (BU-27C)

Rating: 20 Amps (BU-27) or 40 Amps (BU-27C)

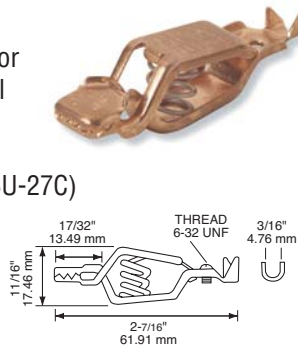

Geophone Clip

Model # BU-27CG/BU-27CGW

Crimp or screw connection; jaw opens 0.625" (16 mm) max; curved jaws clip on to seismograph rings

Material: solid copper; *Spring:* steel

Length: 2.4" (61.1mm)

Rating: 40 Amps

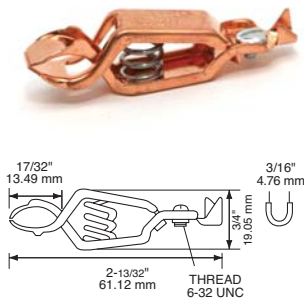

General Purpose/Geophone Clips

Model # BU-29-*

Protective flexible vinyl insulator for 27, 27C, 27CG, 27CGW

Material: PVC

Length: 3.5" (88.9mm)

***Std. Colors:** -0 Black, -2 Red, -4 Yellow, -5 Green, -6 Blue, -9 White



Insulator for General Purpose/Geophone Clips

Model # BU-90-*

Protective flexible vinyl insulator for 27, 27C, 27CG and 27CGW

Accepts larger wires or cables than BU-29-*

Material: PVC

Length: 3.375" (92mm)

***Std. Colors:** -0 Black, -2 Red, -4 Yellow, -5 Green, -6 Blue, -9 White

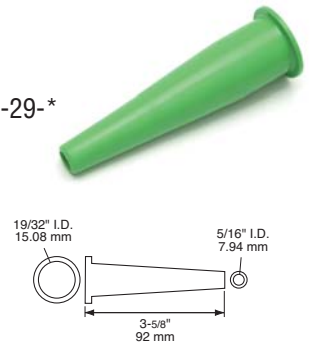

Heavy Duty Clip

Model # BU-24APN/BU-24APS

Crimp or screw connection; jaw opens 0.75" (19 mm) max; clip unmarked (BU-24APN) and marked positive (BU-24APS)

Material: zinc-plated steel; *Spring:* steel

Length: 2.84" (72.23mm)

Rating: 25 Amps

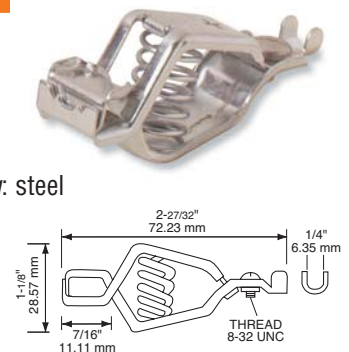

Automotive Clip

Model # BU-25/BU-25C

Crimp or screw connection; jaw opens 0.75" (19 mm) max; teeth mesh on three sides of the jaw

Material: zinc-plated steel (BU-25) or solid copper (BU-25C); *Spring:* steel

Length: 3" (72.6mm)

Federal Spec: CID AA59466-009 (BU-25C)

Rating: 40 Amps (BU-25) or 75 Amps (BU-25C)

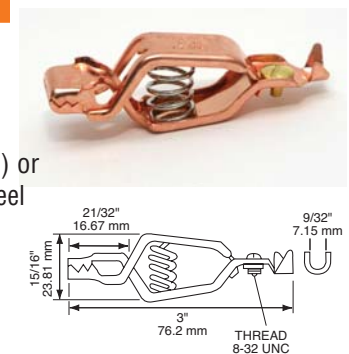

Insulator for Automotive Clip

Model # BU-26-*

Protective flexible vinyl insulator for 24A, 25, 25C

Material: PVC

Length: 3.88" (98.4 mm)

***Std. Colors:** -0 Black, -2 Red, -4 Yellow, -5 Green, -6 Blue, -9 White

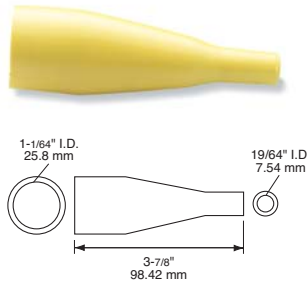

Heavy Duty Clip for Battery and Test Work

Model # BU-21APN/BU-21APS/BU-21CPN/BU-21CPS

Crimp or screw connection; copper version (21C) equipped with removable copper lug; jaw opens 1.06" (27 mm) max; clip unmarked (BU-21APN/CPN) and marked positive (BU-21APS/CPS)

Material: zinc-plated steel (21A) or solid copper (21C); *Spring:* steel

Length: 4.11" (104.4mm)

Federal Spec: CID AA59466-010 (BU-21CPN)

Rating: 50 Amps (21A) or 100 Amps (21C)

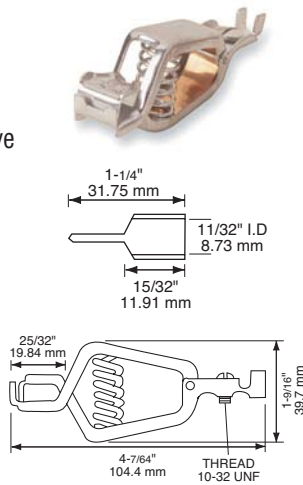

Insulator for Heavy Duty Battery Test Clip

Model # BU-23-*

Protective flexible vinyl insulator for 21A, 21C

Material: PVC

Length: 5" (127mm)

***Std. Colors:** -0 Black, -2 Red, -4 Yellow, -5 Green, -6 Blue, -9 White



Heavy Duty Clip for Grounding Applications

Model # BU-11APN/BU-11APS/BU-11CPN/BU-11CPS

Copper version has a lug connection

Jaw opens 1.625" (41.3 mm) max

Clip unmarked (BU-11APN/CPN) and marked positive (BU-11APS/CPS)

Material: zinc-plated steel (11A) or solid copper (11C); *Spring:* steel

Length: 6" (152.4 mm)

Federal Spec: CID AA59466-011 (BU-11CPN)

Rating: 100 Amps (11A) or 200 Amps (11C)

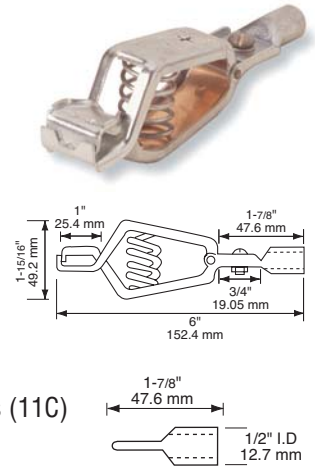

Insulator for Heavy Duty Clip

Model # BU-13-*

Protective flexible vinyl insulator for 11A, 11C

Material: PVC

Length: 6.8" (173mm)

***Std. Colors:** -0 Black, -2 Red, -4 Yellow, -5 Green, -6 Blue, -9 White



Welding Clip

Model # BU-33C

Lug connection

Jaw opens 1.81" (46 mm) max

Material: solid copper

Length: 7.75" (196.8mm)

Federal Spec: CID AA59466-012

Rating: 300 Amps

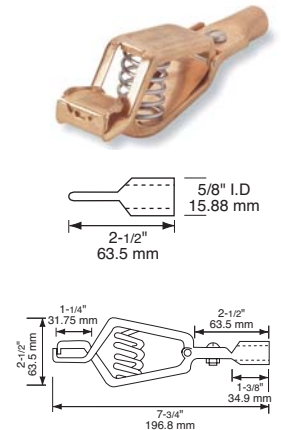

Insulator for Welding Clip

Model # BU-35-*

Protective flexible vinyl insulator for 33C

Material: PVC

Length: 8.75" (222mm)

***Std. Colors:** -0 Black, -2 Red,

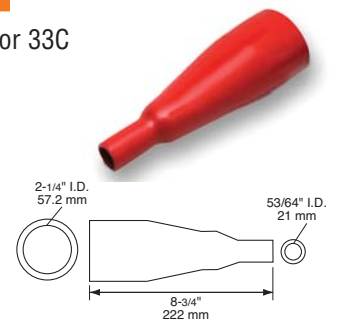

Grounding Clamp

Model # BU-58

Attaches to pipe up to 1 3/8" outer diameter

Material: zinc-plated steel

Length: 2.31" (58.75mm)

Rating: 50 Amps



Micro Plier-Type Clip

Model # BU-40A-*/BU-40C-*

Solder or crimp connection

Jaw opens 0.75" (19 mm) max

Material: nickel-plated steel (BU-40A) or solid copper (BU-40C), PVC insulator (BU-42PR-*)

Length: 2.3" (58mm)

***Std. Colors:** Insulator (BU-42PR-*) -0 Black, -2 Red, -4 Yellow, -5 Green, -6 Blue, -9 White

Rating: 15 Amps (BU-40A), 20 Amps (BU-40C)



Insulator for Micro Plier-Type Clip

Model # BU-42PR-*

Protective flexible vinyl insulator for BU-40

Material: PVC

Length: 1" (25.4mm)

***Std. Colors:** -0 Black, -2 Red, -4 Yellow, -5 Green, -6 Blue, -9 White



Miniature Plier-Type Clip

Model # BU-46A-*/BU-46C-*

Solder or crimp connection

Jaw opens 1.125" (28.6 mm) max

Material: copper-plated steel (BU-46A) or solid copper (BU-46C), PVC insulator (BU-46PR-*)

Length: 2.88" (98.42mm)

***Std. Colors:** Insulator (BU-46PR-*) in -0 Black, -2 Red

Rating: 50 Amps (46A) or 75 Amps (46C)

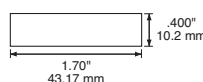
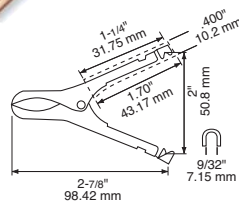

Insulator for Miniature Plier-Type Clip

Model # BU-46PR-*

Protective flexible vinyl insulator for BU-46

Material: PVC

Length: 1.7" (43.18mm)

***Std. Colors:** -0 Black, -2 Red,



Plier-Type Clip

Model # BU-41A-*/BU-41APN/BU-41C-*/BU-41CPN

Jaw opens 1.625" (41.3 mm) max

Locks on to both side and top mounted battery terminals

Material: copper-plated steel (BU-41A) or solid copper (BU-41C), PVC insulator (BU-43PR-*)

Length: 6" (152mm)

***Std. Colors:** Insulator (BU-43PR-*) in -0 Black, -2 Red, -4 Yellow, -5 Green, -6 Blue, -9 White

Federal Spec: CID AA59466-014 BU-41-CPS-VZZZ-2 (red) and CID AA59466-015, BU-41CPN-VZZZ-0 (black)

Rating: 200 Amps (41A) or 400 Amps (41C)

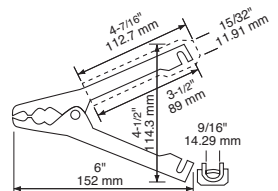
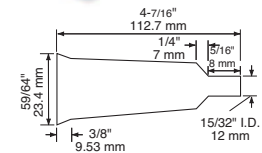

Insulator for Plier-Type Clip

Model # BU-43PR-*

Protective flexible vinyl insulator for BU-41

Material: PVC

Length: 4.4" (112.73mm)

***Std. Colors:** -0 Black, -2 Red, -4 Yellow, -5 Green, -6 Blue, -9 White



Insulated Battery Clip

Model # BU-102B-*/BU-102BK-*

Fully insulated clip with serrated jaws; BU-102BK-* has Kelvinized isolated jaws and no copper shunt

Material: *Housing:* glass filled nylon; *Jaw:* copper; *Spring:* music wire, zinc plated

Length: 6.5" (165mm)

***Std. Colors:** -0 Black, -2 Red

Rating: 300 Amps



Insulated Welding Clip

Model # BU-102W-*

Fully insulated clip with serrated contact pad and braided copper shunt

Material: *Housing:* glass filled nylon;
Jaw: copper; *Spring:* music wire, zinc plated

Length: 6.5" (165mm)

***Std. Colors:** -0 Black, -2 Red

Rating: 400 Amps



Epoxy Coated Battery Clip

Model # BU-X15400-*

Jaw opens 1.50" (38.1 mm) max

Locks on to both side and top mounted battery terminals

Material: steel, epoxy coated clips with copper plated jaws

Length: 6.75" (171.45mm)

***Std. Colors:** -0 Black, -2 Red

Rating: 200 Amps



Kelvin Clip

Model # BU-75K

Jaw opens 0.313" (7.9 mm) max

Isolated jaws

Material: Silver/Gold tip contacts, nylon housing

Length: 1.625" (41.28mm)

Rating: 10 Amps

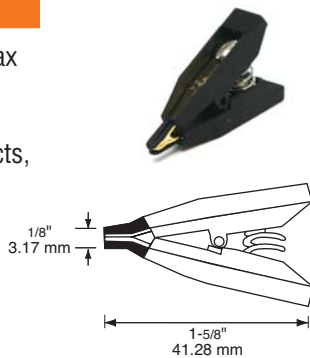

Kelvin Clip

Model # BU-78K

Jaw opens 0.5" (12 mm) max

Isolated jaws

Material: Gold contacts

Length: 2.28" (57.91mm)

Rating: 10 Amps

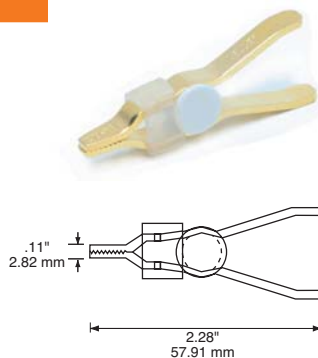

Small Angled Nose Telecom Clip with Bed of Nails

Model # JP-25182-***

Mueller – J.S. Popper brand

Jaw opens 1.0" (25.4mm)

Uses bed of nails to pierce insulation

Material: nickel-silver jaws; includes brass screw, brass nut, brass washer, and bronze star washer

Length: 2.34" (59.4mm)

Connection Options: -N Without Hardware, -L With Loose Hardware, -J Banana Jack, -TJ Threaded Banana Jack

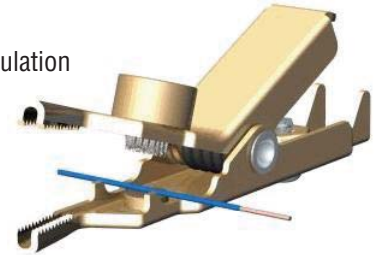

Large Angled Nose Telecom Clip with Single Spike

Model # JP-8099-***

Mueller – J.S. Popper brand

Jaw opens 1.0" (25.4mm)

Uses single spike to pierce insulation

Material: nickel-silver jaws; includes brass screw, brass nut, brass washer, and bronze star washer

Length: 2.61" (66.4mm)

Connection Options: -N Without Hardware, -L With Loose Hardware, -J Banana Jack, -TJ Threaded Banana Jack



Large Angled Nose Telecom Clip with Hex Screw Attached Single Spike

Model # JP-8078-***

Mueller – J.S. Popper brand

Jaw opens 1.0" (25.4mm)

Uses single spike to pierce insulation

Material: nickel-silver jaws; includes brass screw, brass nut, brass washer, and bronze star washer

Length: 2.61" (66.4mm)

Connection Options: -N Without Hardware, -L With Loose Hardware, -J Banana Jack, -TJ Threaded Banana Jack

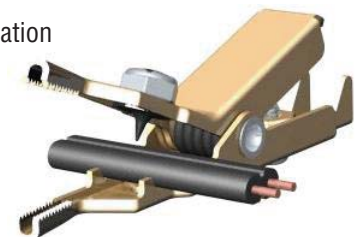

Large Angled Nose Telecom Clip with Bed of Nails and Single Spike

Model # JP-8783-***

Mueller – J.S. Popper brand

Jaw opens 1.0" (25.4mm)

Uses single spike and bed of nails to pierce insulation

Material: nickel-silver jaws; includes brass screw, brass nut, brass washer, and bronze star washer

Length: 2.61" (66.4mm)

Connection Options: -N Without Hardware, -L With Loose Hardware, -J Banana Jack, -TJ Threaded Banana Jack

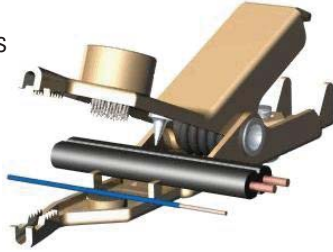

Large Straight Nose Telecom Clip with Single Spike

Model # JP-33699-***

Mueller – J.S. Popper brand

Jaw opens 1.0" (25.4mm)

Uses single spike to pierce insulation

Material: nickel-silver jaws; includes brass screw, brass nut, brass washer, and bronze star washer

Length: 2.61" (66.4mm)

Connection Options: -N Without Hardware, -L With Loose Hardware, -J Banana Jack, -TJ Threaded Banana Jack

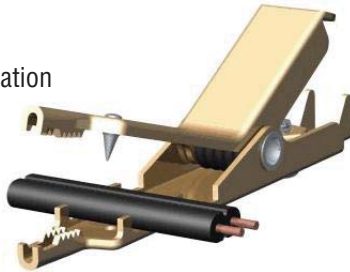

Large Straight Nose Telecom Clip with Bed of Nails and Single Spike

Model # JP-33674-***

Mueller – J.S. Popper brand

Jaw opens 1.0" (25.4mm)

Uses single spike and bed of nails to pierce insulation

Material: nickel-silver jaws; includes brass screw, brass nut, brass washer, and bronze star washer

Length: 2.61" (66.4mm)

Connection Options: -N Without Hardware, -L With Loose Hardware, -J Banana Jack, -TJ Threaded Banana Jack

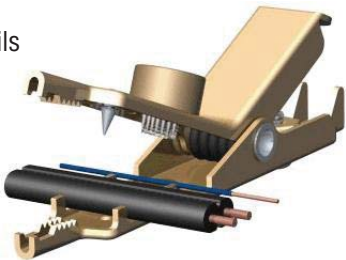

Contact Clip with Bed of Nails

Model #JP-5869-B

Mueller – J.S. Popper brand

Jaw opens 0.52" (13.2mm)

Uses bed of nails to pierce insulation

Material: steel

Length: 2.4" (61.0mm)



Contact Clip with Circle of Nails

Model # JP-5869-C

Mueller – J.S. Popper brand

Jaw opens 0.52" (13.2mm)

Uses circle of points to pierce insulation

Material: steel

Length: 2.4" (61.0mm)



Insulator for Telecom Clips

Model # JP-8681-*

Mueller – J.S. Popper brand

Protective flexible vinyl insulator for 25182, 8099, 8078, 8783, 33699, 33674

Material: PVC

Length: 2.4" (61.0mm)

***Std. Colors:** -0 Black, -2 Red, -4 Yellow, -5 Green, -6 Blue, -9 White

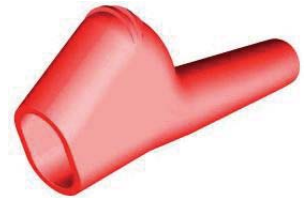

Cut Insulator for Telecom Clips

Model # JP-8681-C*

Mueller – J.S. Popper brand

Protective flexible vinyl insulator for telecom clips with banana jack or threaded banana jack connections

Material: PVC

Length: 1.8" (45.7mm)

***Std. Colors:** -0 Black, -2 Red, -4 Yellow, -5 Green, -6 Blue, -9 White

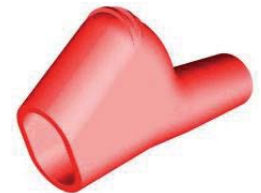



Mueller's jacks, binding posts and banana plugs ensure a reliable connection. All plug bodies are nickel-plated brass. Shielded jacks provide additional user safety where it is required.

Color Key		
0=Black	4=Yellow	6=Blue
2=Red	5=Green	9=White

Banana Plug With 8-32 Thread

Model # BU-00226-*

Nine leaf cage spring 4mm banana plug

Material: *Banana Plug:* nickel-plated brass body; *Spring:* nickel-plated phosphor bronze; *Insulator:* ABS

Length: 1.66" (42.13mm)

***Std. Colors:** -0 Black, -2 Red

Rating: 1000 Volts, 15 Amps (hands free)

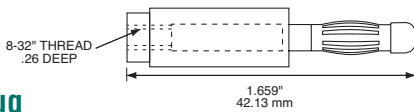

Threaded Banana Plug

Model # BU-00241

Material: *Banana Plug:* nickel-plated brass body; *Spring:* nickel-plated phosphor bronze

Length: 1.21" (31mm)

Rating: 15 Amp



Solderless Banana Plug

Model # BU-00243-*

Material: *Banana Plug:* nickel-plated brass body; *Spring:* nickel-plated phosphor bronze; *Insulator:* ABS

Length: 1.1" (28mm)

***Std. Colors:** -0 Black, -2 Red

Rating: 15 Amp



Solderless Banana Plug-Hex Design

Model # BU-00244-*

Material: *Banana Plug:* nickel-plated brass body; *Spring:* nickel-plated phosphor bronze; *Insulator:* ABS

Length: 1.15" (29mm)

***Std. Colors:** -0 Black, -2 Red

Rating: 15 Amps

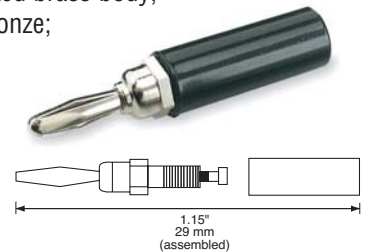

Set Screw Banana Plug

Model # BU-00245-*

Material: *Banana Plug:* nickel-plated brass body; *Spring:* nickel-plated phosphor bronze; *Insulator:* ABS

Length: 1.08" (27mm)

***Std. Colors:** -0 Black, -2 Red

Rating: 15 Amps

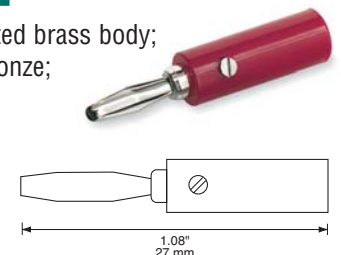

Banana Plugs and Jacks

Tapered Handle Banana Plug

Model # BU-00246-*

Material: *Banana Plug:* nickel-plated brass body; *Spring:* nickel-plated phosphor bronze; *Insulator:* ABS

Length: 1.02" (26mm)

*Std. Colors: -0 Black, -2 Red

Rating: 15 Amps

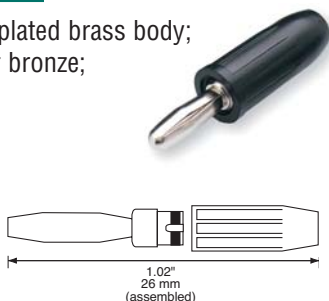

Stackable Banana Plug

Model # BU-00249-*

Material: *Banana Plug:* nickel-plated brass body; *Spring:* nickel-plated phosphor bronze; *Insulator:* ABS

Length: 1.68" (43mm)

*Std. Colors: -0 Black, -2 Red

Rating: 15 Amps



Unshrouded Stackable Banana Plug

Model # BU-16-*

Material: *Banana Plug:* nickel-plated brass body; *Spring:* nickel-plated beryllium copper; *Insulator:* Nylon

Length: 1.88" (47.7mm)

*Std. Colors: -0 Black, -2 Red

Rating: 1000 Volts, 15 Amps (Hands free)



Insulated Stackable Banana Plug

Model # BU-31101-*

Material: *Banana Plug:* nickel-plated brass body; *Spring:* nickel-plated beryllium copper; *Insulator:* nylon

Length: 2.45" (62.23mm)

*Std. Colors: -0 Black, -2 Red

Rating: 20 Amps



Cable Mountable 4mm Shrouded Banana Plug

Model # BU-32603-*

Material: *Banana Plug:* nickel-plated brass; *Insulator:* nylon

Length: 1.91" (48.5mm)

*Std. Colors: -0 Black, -2 Red

Rating: 1000V, category III, 1500V, category II, 20 Amps, IEC 1010 Compliant



Insulated Banana Jack To Standard Banana Plug

Model # BU-32101-*

Material: *Banana Plug:* nickel-plated brass body; *Spring:* nickel-plated beryllium copper; *Insulator:* nylon

Length: 2.61" (66.3mm)

*Std. Colors: -0 Black, -2 Red, -4 Yellow, -6 Blue

Rating: 1000 V, 15 Amps (hands free), IEC 1010 Compliant



Insulated Banana Coupler

Model # BU-32601-*

Material: *Banana Plug:* nickel-plated brass; *Insulator:* nylon

Length: 2.50" (63.5mm)

*Std. Colors: -0 Black, -2 Red, -4 Yellow, -6 Blue

Rating: 1000V, 15 Amps, IEC 1010 Compliant



Dual Banana Plug

Model # BU-00247-*

Material: *Banana Plug:* nickel-plated brass body; *Spring:* nickel-plated phosphor bronze; *Insulator:* PVC

Length: 1.62" (41mm)

*Std. Colors: -0 Black, -2 Red, -4 Yellow, -5 Green, -6 Blue

Rating: 15 Amps

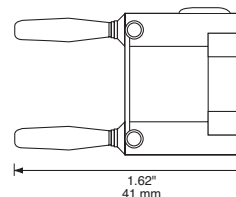

Insulated Banana Jack

Model # BU-00233-*

Material: *Banana Jack:* nickel-plated brass body; *Insulator:* nylon

Length: 0.66" (17mm)

***Std. Colors:** -0 Black, -2 Red

Rating: 15 Amp

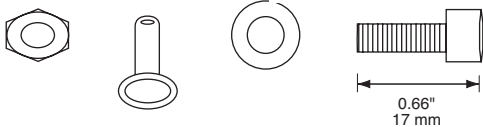

Insulated Phone Tip Jack

Model # BU-00234-*

Material: *Banana Jack:* nickel-plated brass body; *Spring:* nickel-plated phosphor bronze; *Insulator:* ABS

Length: 1" (25mm)

***Std. Colors:** -0 Black, -2 Red

Rating: 15 Amp

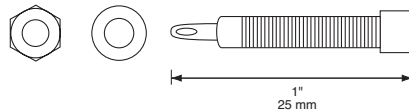

Pressfit Insulated Banana Jack with Solder Pin Connection

Model # BU-31602-*

Material: *Banana Plug:* nickel-plated brass; *Insulator:* Dupont 101L

Length: 1.25" (31.75mm)

***Std. Colors:** -0 Black, -2 Red, -4 Yellow, -6 Blue

Rating: 1000 V, 15 Amps, IEC 1010 Compliant



Pressfit Insulated Banana Jack with Spade Connection

Model # BU-31603-*

Material: *Banana Plug:* nickel-plated brass; *Insulator:* Dupont 101L

Length: 1.37" (34.8mm)

***Std. Colors:** -0 Black, -2 Red, -4 Yellow, -6 Blue

Rating: 1000 V, 15 Amps, IEC 1010 Compliant



Slim-Line Five Way Binding Post-Threaded

Model # BU-00281-*

Material: *Post:* nickel-plated brass; *Insulator:* nylon

Length: 2" (51mm)

***Std. Colors:** -0 Black, -2 Red

Rating: 15 Amps

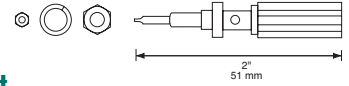

Five-Way Binding Post

Model # BU-00282-*

Material: *Post:* nickel-plated brass; *Insulator:* nylon

Length: 2.10" (53mm)

***Std. Colors:** -0 Black, -2 Red

Rating: 15 Amps



Dual Five-Way Binding Post

Model # BU-00283

Material: *Post:* nickel-plated brass; *Insulator:* nylon

Length: 1.80" (46mm)

Rating: 15 Amps

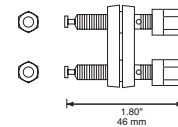
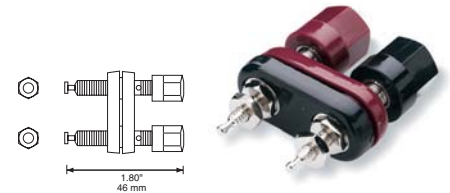

Screw-in Safety Socket with Stud and Metal Nut

Model # BU-31607-*

Material: *Hardware:* nickel-plated brass; *Insulator:* ABS-nylon composite

Length: 1.53" (39mm)

***Std. Colors:** -0 Black, -2 Red

Rating: 600V, category III, 1000V, category II, 35 Amps, IEC 1010 Compliant



Screw-in Safety Socket with Spade and Metal Nut

Model # BU-31609-*

Material: *Hardware:* nickel-plated brass; *Insulator:* ABS-nylon composite

Length: 1.26" (32mm)

***Std. Colors:** -0 Black, -2 Red

Rating: 600V, category III, 1000V, category II, 35 Amps, IEC 1010 Compliant



Grabbers, Probes and Spade Terminals

Mueller grabber clips and test probes are available in a wide variety of sizes to ensure that even the most hard to reach test point is easily accessible. We provide a fast and easy connection to terminals and component test leads.



Color Key

0=Black	4=Yellow	6=Blue
2=Red	5=Green	9=White

Plunger Clip

Model # BU-00201-*/BU-00202-*/BU-00203-*

Material: *Cap & Body:* glass filled nylon; *Spring:* stainless steel; *Contact:* beryllium copper; insulated to a single contact point

Length: 1.75" (44mm) (BU-00201-*); 2.50" (63mm) (BU-00202-*); 3.50" (88mm) (BU-00203-*)

***Std Colors:** -0 black, -2 red

Rating: 1000 Volts, 10 Amps



Mini-Micro Plunger Clip

Model # BU-00208-*

Material: *Cap & Body:* tough, durable nylon; *Spring:* stainless steel compression coil; *Contact:* gold-plated beryllium copper

Length: 1.75" (44mm)

***Std Colors:** -0 Black, -2 Red

Rating: 600 Volts, 3 Amps



Safety Plunger Clip Adapter

Model # BU-00207-*

Material: *Cap & Body:* nylon; *Spring:* stainless steel; *Contact:* beryllium copper

Length: 2.23" (56.64mm)

***Std Colors:** -0 Black, -2 Red

Rating: 1000 Volts, 15 Amps



Right Angle Insulated Plunger Hook Clip

Model # BU-20431-*

Compatible with all shrouded, unshrouded, or retractable 0.16" (4mm) banana plugs

Material: *Housing:* nylon. *Contact:* nickel-plated beryllium copper

Length: 4.60" (116.84mm); the hook extends 0.41" (10mm) when fully depressed

***Std Colors:** -0 Black, -2 Red, -4 Yellow, -6 Blue

Rating: 1000V, 15 Amps, IEC 1010 Compliant



Right Angle Insulated Plunger Clamp Clip

Model # BU-20432-*/BU-20433-*

Compatible with all shrouded, unshrouded, or retractable 0.16" (4mm) banana plugs

Material: *Housing:* nylon;
Contact: nickel-plated beryllium copper

Length: 5.50" (139.7mm) (BU-20432-*);
7.50" (190.5mm) (BU-20433-*)

***Std Colors:** -0 Black, -2 Red, -4 Yellow, -6 Blue

Rating: 1000V, 1 Amps, IEC 1010 Compliant



Right Angle Insulated Plunger Jaw Clip

Model # BU-20434-*

Compatible with all shrouded, unshrouded, or retractable 0.16" (4mm) banana plugs

Material: *Housing:* nylon;
Contact: nickel-plated steel

Length: 5.26" (133.6mm); the steel jaws extend 0.48" (12mm) and open to 1" (25mm)

***Std Colors:** -0 Black, -2 Red, -4 Yellow, -6 Blue

Rating: 1000V, 15 Amps, IEC 1010 Compliant



Insulated Plug-On Test Prod With Stainless Steel Tip

Model # BU-26101-*

Compatible with all shrouded, unshrouded, or retractable 0.16" (4mm) banana plugs

Material: *Housing:* nylon;
Contact: nickel-plated brass

Length: 3" (76.2mm)

***Std Colors:** -0 Black, -2 Red, -4 Yellow, -6 Blue

Rating: 1000V, 20 Amps, IEC 1010 Compliant



Insulated Plug-On Test Prod With 8-32 Thread

Model # BU-26106-*

Compatible with all shrouded, unshrouded, or retractable 0.16" (4mm) banana plugs

Material: *Housing:* nylon;
Contact: nickel-plated brass

Length: 3.3" (83mm)

***Std Colors:** -0 Black, -2 Red, -4 Yellow, -6 Blue

Rating: 1000V, 20 Amps, IEC 1010 Compliant



Ultra Tech Test Prod

Model # BU-26130-*

Compatible with all shrouded, unshrouded, or retractable 0.16" (4mm) banana plugs

Material: *Housing:* nylon;
Contact: nickel-plated brass

Length: 6.27" (159.3mm)

***Std Colors:** -0 Black, -2 Red, -4 Yellow, -6 Blue

Rating: 1000V, IEC 1010 Compliant



Safety Spade Terminal

Model # BU-30214-*

Compatible with all shrouded, unshrouded, or retractable 0.16" (4mm) banana plugs

Material: *Housing:* ABS-nylon;
Contact: nickel-plated brass

Length: 2.55" (64.8mm)

***Std Colors:** -0 Black, -2 Red, -4 Yellow, -5 Green, -6 Blue

Rating: 1000V, category III, 1500V, category II, 30 Amps, IEC 1010 Compliant





Test Leads and Patch Cords

Mueller manufactures a full line of test and interconnection leads for almost any application. For nearly a century, technicians and engineers have looked to Mueller as “perfection...for the best connection.”

Wire Table

Designation	AWG	Description	O.D.	Insulation	Temp	Rating
M	18	413/44 copper	.140" (3.56mm)	Silicone	150°C/-80°C	3000V, 22A
N	18	65/36 tinned copper	.140" (3.56mm)	PVC	80°C/-50°C	5000V, 6.5A
A	20	41/36 tinned copper	.088" (2.24mm)	PVC	105°C/-25°C	300V, 6.5A
E	22	19/34 tinned copper	.062" (1.56mm)	PVC	105°C/-55°C	1000V, 600V UL1483, 300V UL1509, 3.5A
D	18	65/36 tinned copper	.140" (3.56mm)	PVC	90°C	3000V, 6.5A

Order Key

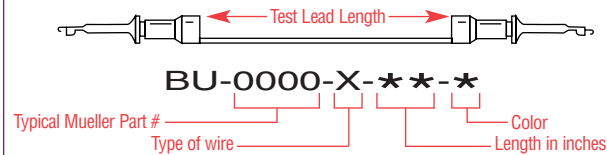

Coaxial Cables

Rating
B RG-58C/U
C RG-58C/U connected to 20AWG with Y-block
F RG-174C/U
L Twisted Pair Cable

Micro-Plunger Clip on Both Ends

Model # BU-1010-A-**-*

Mini-Plunger Clip on Both Ends

Model # BU-1111-A-**-*

Material: Hook-up Wire: #20 (41/36) AWG tinned copper with 105°C PVC insulation; Plunger: nylon housing, stainless steel spring, beryllium copper contact

****Length:** -12" (.3m), 24" (.6m), 36" (.9m), 48" (1.2m), 60" (1.5m)

***Std. Colors:** -0 Black, -2 Red

Rating: Hands free testing at 300V Category II, 5 Amps



Mini-Plunger to Stackable Banana Plug

Model # BU-1120-A-**-*

Material: Banana Plug: ABS housing, brass body and beryllium copper, nickel-plated, nine-leaf cage spring; Hook-up Wire: #20 (41/36) AWG tinned copper with 105°C PVC insulation; Plunger: nylon housing, stainless steel spring and beryllium copper contact

****Length:** -12" (.3m), 24" (.6m), 36" (.9m), 48" (1.2m), 60" (1.5m)

***Std. Colors:** -0 Black, -2 Red

Rating: Hands free testing at 300V, 5 Amps



Mini-Plunger to BNC Male with RG58

Model # BU-1150-C-**-0

Material: BNC Connector: MIL-C-30912, gold-plated center contact and silver-plated body; Coaxial Cable: shielded RG58C/U, MIL-C-17F, 50 ohm; Plunger: nylon housing, stainless steel spring and beryllium copper contact

****Length:** -12" (.3m), 24" (.6m), 36" (.9m), 48" (1.2m), 60" (1.5m)

Rating: Hands free testing at 300 VRMS



Mini-Micro-Plunger to Stackable Banana Plug

Model # BU-1420-A-**-*

Material: Banana Plug: ABS housing, brass body and beryllium copper, nickel-plated, nine-leaf cage spring; Hook-up Wire: #20 (41/36) AWG tinned copper with 105°C PVC insulation; Plunger: nylon housing, stainless steel spring and gold-plated, beryllium copper contact

****Length:** -12" (.3m), 24" (.6m), 36" (.9m), 48" (1.2m), 60" (1.5m)

***Std. Colors:** -0 Black, -2 Red

Rating: Hands free testing at 300V, 5 Amp



Stackable Single Banana Plugs on Both Ends

Model # BU-2020-A-**-*

Material: *Banana Plug:* ABS housing, brass body and beryllium copper, nickel-plated, nine-leaf cage spring; *Hook-up Wire:* #20 (41/36) AWG tinned copper with 105°C PVC insulation

****Length:** -12" (.3m), 24" (.6m), 36" (.9m), 48" (1.2m), 60" (1.5m)

***Std. Colors:** -0 Black, -2 Red

Rating: hands free testing at 300V, 10 Amps



Insulated Alligator Clip to Stackable Banana Plug

Model # BU-2030-A-**-*

Material: *Banana Plug:* ABS housing, brass body and beryllium copper, nickel-plated, nine-leaf cage spring; *Alligator Clip:* nickel-plated steel with PVC insulator; *Hook-up Wire:* #20 (41/36) AWG tinned copper with 105°C PVC insulation

****Length:** -12" (.3m), 24" (.6m), 36" (.9m), 48" (1.2m), 60" (1.5m)

***Std. Colors:** -0 Black, -2 Red

Rating: hands free testing at 300V, 10 Amps



Insulated Mini-Alligator Clip to Stackable Banana Plug

Model # BU-2031-A-**-*

Material: *Banana Plug:* ABS housing, brass body and beryllium copper, nickel-plated, nine-leaf cage spring; *Alligator Clip:* nickel-plated steel with PVC insulator; *Hook-up Wire:* #20 (41/36) AWG tinned copper with 105°C PVC insulation

****Length:** -12" (.3m), 24" (.6m), 36" (.9m), 48" (1.2m), 60" (1.5m)

***Std. Colors:** -0 Black, -2 Red

Rating: Hands free testing at 300V, 10 Amp



Multiple Feature Test Prod to Right Angle Shrouded Banana Plug

Model # BU-2241-D-48-*

Material: *Needle:* stainless steel; *Banana plugs:* nickel-plated brass; *Housing:* ABS; *Hook-up wire:* #18 AWG (65/36) tinned copper with 90°C PVC insulation

***Std. Colors:** -0 Black, -2 Red

Rating: 1000V Category II, 20 Amps



Shrouded Right Angle Banana Plug

Model # BU-2243-D-48-*

The stainless steel probe is Teflon® insulated except for the working end to prevent unwanted contact with other components that may be in the way

Material: *Needle:* stainless steel; *Banana Plugs:* nickel-plated brass; *Housing:* ABS; *Hook-up wire:* #18 AWG (65/36) tinned copper with 90°C PVC insulation

***Std. Colors:** -0 Black, -2 Red

Rating: 600V Category II, 20 Amps



Multiple Feature Test Prod to Unshrouded Banana Plug

Model # BU-2641-D-48-*

Material: *Needle:* stainless steel; *Banana Plugs:* nickel-plated brass; *Housing:* ABS; *Hook-up wire:* #18 AWG (65/36) tinned copper with 90°C PVC insulation

***Std. Colors:** -0 Black, -2 Red

Rating: 600V, 10 Amps



Multiple Feature Test Prod to Unshrouded Right Angle Banana Plug

Model # BU-2741-D-48-*

Material: *Needle:* stainless steel; *Banana plugs:* nickel-plated brass; *Housing:* ABS; *Hook-up wire:* #18 AWG (65/36) tinned copper with 90°C PVC insulation

***Std. Colors:** -0 Black, -2 Red

Rating: 600V, 10 Amps



Unshrouded Banana Plugs on Both Ends – Ultra-Flex-Silicone

Model # BU-2929-M-**-*

Material: *Unshrouded Banana Plugs:* Mueller No. Bu-16-*; *Hook-up wire:* #18 AWG (65/36) tinned copper with 90°C PVC insulation

****Length:** -10" (.25m), 20" (.5m), 39" (1m)

***Std. Colors:** -0 Black, -2 Red

Rating: Hands free testing at 3 kV, 20 Amps



Shrouded Banana Plug to Safety Test Prod - Silicone

Model # BU-4061-M-39-*

Material: *Banana Plugs:* nickel-plated brass body, nickel-plated beryllium copper spring; *Probe:* stainless steel tip with 8-32 UNC thread; *Hook-up Wire:* #18 AWG, silicone insulator

*Std. Colors: -0 Black, -2 Red, -4 Yellow, -6 Blue

Rating: 1000V, 20 Amps, IEC 1010 compliant



Shrouded Right Angle Banana Plug to Safety Test Prod - Silicone

Model # BU-4062-M-39-*

Material: *Banana Plugs:* nickel-plated brass body, nickel-plated beryllium copper spring; *Probe:* stainless steel tip with 8-32 UNC thread; *Hook-up Wire:* #18 AWG, silicone insulator

*Std. Colors: -0 Black, -2 Red, -4 Yellow, -6 Blue

Rating: 1000V, 20 Amps, IEC 1010 compliant



Stackable 0.080" (2.0mm) Pin Plug on Both Ends

Model # BU-4444-A-**-*

Tip jack accepts 0.080" (2.0mm) diameter pin jack contact

Material: *Pin Plug:* 0.080" (2.0mm) diameter; 0.500" (12.7mm) long, nickel-plated brass pin tip, nickel-plated beryllium copper spring, ABS housing; *Hook-up Wire:* #22 (19/34) AWG tinned copper with 105°C PVC insulation

**Length: -12" (.3m), 24" (.6m), 36" (.9m)

*Std. Colors: -0 Black, -2 Red

Rating: Hands free testing at 300VAC, 15 Amps



Shrouded Banana Plug on Both Ends – Silicone

Model # BU-6161-M-39-*

Material: *Banana Plugs:* nickel-plated brass body, nickel-plated beryllium copper spring; *Hook-up Wire:* #18 AWG, silicone insulator

*Std. Colors: -0 Black, -2 Red, -4 Yellow, -6 Blue

Rating: 1000V, 20 Amps, IEC 1010 compliant



Right Angle Shrouded Banana Plug to Shrouded Banana Plug - Silicone

Model # BU-6162-M-39-*

Material: *Banana Plugs:* nickel-plated brass body, nickel-plated beryllium copper spring; *Hook-up Wire:* #18 AWG, silicone insulator

*Std. Colors: -0 Black, -2 Red, -4 Yellow, -6 Blue

Rating: 1000V, 20 Amp, IEC 1010 compliant



Stackable Dual Banana Plug to Mini-Micro-Plunger with RG58

Model # BU-7014-B-**-*

Material: *Plunger:* nylon housing, stainless steel spring and beryllium copper contact; *Double Banana Plug:* ABS housing, brass body and beryllium copper, nickel-plated, nine-leaf cage spring; *Coaxial Cable:* shielded RG58C/U, MIL-C-17F, 50 ohm

**Length: -12" (.36m), 24" (.6m), 36" (.9m)

*Std. Colors: -0 Black, -2 Red

Rating: hands free testing at 300 VRMS



Stackable Dual Banana Plug to Stackable Single Banana Plug with RG58

Model # BU-7020-B-**-*

Material: *Single Banana Plug:* ABS housing, brass body and beryllium copper, nickel-plated, nine-leaf cage spring; *Double Banana Plug:* ABS housing, brass body and beryllium copper, nickel-plated, nine-leaf cage spring; *Coaxial Cable:* shielded RG58C/U, MIL-C-17F, 50 ohm

**Length: -12" (.36m), 24" (.6m), 36" (.9m)

*Std. Colors: -0 Black, -2 Red

Rating: Hands free testing at 500 VRMS



Stackable Dual Banana Plug to Mini-Alligator Clip with RG58

Model # BU-7031-B--***

Material: *Alligator clip:* nickel-plated steel with PVC insulator; *Double Banana Plug:* ABS housing, brass body and beryllium copper, nickel-plated, nine-leaf cage spring; *Coaxial Cable:* shielded RG58C/U, MIL-C-17F, 50 ohm

****Length:** -12" (.36m), 24" (.6m), 36" (.9m)

***Std. Colors:** -0 Black, -2 Red

Rating: Hands free testing at 300 VRMS



Stackable Dual Banana Plug to Stackable Pin Plug with RG58

Model # BU-7044-B--***

Material: *Pin Plug:* 0.080" (2.0mm) diameter; 0.500" (12.7mm) long, nickel-plated brass pin tip, nickel-plated beryllium copper spring, ABS housing; *Double Banana Plug:* ABS housing, brass body and beryllium copper, nickel-plated, nine-leaf cage spring; *Coaxial Cable:* shielded RG58C/U, MIL-C-17F, 50 ohm

****Length:** -12" (.36m), 24" (.6m), 36" (.9m)

***Std. Colors:** -0 Black, -2 Red

Rating: Hands free testing at 500 VRMS



Stackable Dual Banana Plug on Both Ends with RG58

Model # BU-7070-B--***

Material: *Double Banana Plug:* ABS housing, brass body and beryllium copper, nickel-plated, nine-leaf cage spring; *Coaxial Cable:* shielded RG58C/U, MIL-C-17F, 50 ohm

****Length:** -12" (.3m), 24" (.6m), 36" (.9m), 48" (1.2m), 60" (1.5m)

***Std. Colors:** -0 Black, -2 Red

Rating: Hands free testing at 300 VRMS



Shrouded Dual Banana Plug on Both Ends with RG58

Model # BU-7171-B--0**

Material: *Double Banana Plug:* ABS housing, brass body and beryllium copper, nickel-plated, nine-leaf cage spring; *Coaxial Cable:* shielded #22 AWG (7/30) twisted pair with drain connected to (-) side of one banana plug; side with drain connection is marked; shielded RG58C/U, MIL-C-17F, 50 ohm

****Length:** -12" (.3m), 24" (.6m), 36" (.9m), 48" (1.2m), 60" (1.5m)

Rating: Hands free testing at 500 VRMS



0.025" (.6mm) Square Pin Receptacle on Both Ends

Model # BU-8080-E--***

Material: *Pin Receptacle:* ABS housing, 0.025" (0.6mm) copper-nickel-tin alloy 725 with 0.000030" (0.00076mm) gold contact plating conductor; *Hook-up Wire:* #22 AWG (19/34) tinned copper with 105°C PVC insulation

****Length:** -6" (.15m), 12" (.3m), 24" (.6m), 36" (.9m)

***Std. Colors:** -0 Black, -2 Red

Rating: Hands free testing at 300V, 3 Amp



Insulated Alligator Clips on Both Ends

Model # BU-3030-A--***

Material: *Alligator Clip:* nickel-plated steel with PVC insulator; *Hook-up Wire:* #20 (41/36) AWG tinned copper with 105°C PVC insulation

****Length:** -12" (.3m), 24" (.6m), 36" (.9m), 48" (1.2m), 60" (1.5m)

***Std. Colors:** -0 Black, -2 Red

Rating: Hands free testing at 300V, 10 Amps



Insulated Alligator Clips on Both Ends - Coiled Cord

Model # BU-3030-C-24-*

Material: *Clip:* nickel-plated steel alligator with insulator (BU-60 and BU-62-*); *Coiled Cord:* single conductor 18AWG wire with 4mm O.D.

Length: -24" (.6m) retracted, 120" (3.) extended

***Std. Colors:** -0 Black, -2 Red

Rating: Hands free testing at 300V, 15 Amps



Insulated Alligator Clip to Stackable Dual Banana Plug with RG58

Model # BU-3070-C-**-0

Material: *Alligator Clip:* nickel-plated steel with PVC insulator; *Double Banana Plug:* ABS housing, brass body and beryllium copper, nickel-plated, nine-leaf cage spring; *Coaxial Cable:* Shielded RG58C/U, MIL-C-17F, 50 ohm

****Length:** -12" (.3m), 24" (.6m), 36" (.9m), 48" (1.2m), 60" (1.5m)

Rating: Hands free testing at 300 VRMS



Insulated Mini-Alligator Clip on Both Ends

Model # BU-3131-A-**-*

Material: *Alligator Clip:* nickel-plated steel with PVC insulator; *Hook-up Wire:* #20 (41/36) AWG tinned copper with 105°C PVC insulation

****Length:** -12" (.3m), 24" (.6m), 36" (.9m), 48" (1.2m), 60" (1.5m)

***Std. Colors:** -0 Black, -2 Red

Rating: Hands free testing at 300 VAC, 5 Amps



Insulated Mini-Alligator Lead Set

Model # BU-00285

Material: *Clip:* nickel-plated steel with PVC insulators; *Hook-up Wire:* #22 (19/34) AWG copper with 105°C PVC insulation

Length: 18" (.46m)

Colors: Includes 2 each: Black, Red, Yellow, Green, White

Rating: Hands free testing at 300V, 5 Amp



Insulated Alligator Lead Set

Model # BU-00286

Material: *Clip:* nickel-plated steel with PVC insulators; *Hook-up Wire:* #22 (19/34) AWG copper with 105°C PVC insulation

Length: 12" (.3m)

Colors: Includes 1 each: Black, Red, Yellow, Green, White

Rating: Hands free testing at 300V, 7 Amp



Insulated Alligator Lead Set

Model # BU-00287

Material: *Clip:* nickel-plated steel with PVC insulators; *Hook-up Wire:* #22 (19/34) AWG copper with 105°C PVC insulation

Length: 12" (.3m)

Colors: Includes 2 each: Black, Red, Yellow, Green, White

Rating: Hands free testing at 300V, 7 Amp



Shrouded Banana Plug to Piercing Clip - Silicone

Model # JP-7505-83-**-*

Piercing clips are J.S. Popper brand

Material: *Piercing Clip:* JP-8783; *Banana Plugs:* nickel-plated brass body, nickel-plated beryllium copper spring; *Hook-up Wire:* #18 AWG, silicone insulator

****Length:** -12" (.3m), 24" (.6m), 36" (.9m), 48" (1.2m)

***Std. Colors:** -0 Black, -2 Red, -4 Yellow, -6 Blue

Rating: 300V, 3 Amp



Ultra-Flex Test Lead Wires

Model # WI-M-18-*

Material: *Wire:* #18 AWG, silicone

***Std. Colors:** -0 Black, -2 Red, -4 Yellow, -5 Green, -6 Blue, -9 White

Rating: 3kV, 22 Amp



Mueller's coaxial cables and fully insulated BNC receptacles provide an additional margin of safety in connecting to instrumentation such as oscilloscopes, voltmeters, and network analyzers. Our BNC breakout test leads offer a wide variety of connector and clip combinations to meet your testing and connection needs.

Order Key		Coaxial Cables			
		Rating B RG-58C/U C RG-58C/U connected to 20AWG with Y-block F RG-174C/U L Twisted Pair Cable			
BU-0000-X-**-* Typical Mueller Part # Type of wire Color Length in inches					
Color Key		Available Test Lead Lengths			
0=Black	4=Yellow	6=Blue	6"	24"	48"
2=Red	5=Green	9=White	12"	36"	60"

BNC Male on Both Ends

Model # BU-5050-B--0**

Material: *BNC Male Connector:* gold-plated center contact, silver-plated body; (MIL-C-39012); *Coaxial Cable:* shielded RG58C/U, MIL-C17F, 50 ohm

****Length:** -12" (.3m), 24" (.6m), 36" (.9m), 48" (1.2m), 60" (1.5m)

Rating: Hands free testing at 500 VRMS on center conductor



BNC Male with Strain Relief on Both Ends

Model# BU-5454-B--0**

Material: *BNC Male Connector:* MIL-C-39012, silver-plated brass body, gold/nickel plated brass center contact; *Coaxial Cable:* RG58C/U, MIL-C17F, 50 ohm

****Length:** -12" (.3m), 24" (.6m), 36" (.9m), 48" (1.2m), 60" (1.5m)

Rating: Hands free testing at 500 VRMS on center conductor



BNC Male to Stackable Double Banana Plug

Model# BU-5070-B--0**

Material: *BNC Male Connector:* gold-plated center contact, silver-plated body; (MIL-C-39012); *Double Banana Plug:* ABS housing, brass body and beryllium copper, nickel-plated, nine-leaf cage spring; *Coaxial Cable:* shielded RG58C/U, MIL-C-17F, 50 ohm

****Length:** -12" (.3m), 24" (.6m), 36" (.9m), 48" (1.2m), 60" (1.5m)

Rating: Hands free testing at 500 VRMS on center conductor



BNC Female with Strain Relief on Both Ends

Model# BU-5555-B--0**

Material: *BNC Female Connector:* MIL-C-39012, silver-plated brass body, gold/nickel plated brass center contact; *Coaxial Cable:* RG58C/U, MIL-C17F, 50 ohm

****Length:** -12" (.3m), 24" (.6m), 36" (.9m), 48" (1.2m), 60" (1.5m)

Rating: Hands free testing at 500 VRMS on center conductor

Insulated BNC Male to BNC Female

Model# BU-5659-B-**-0

Material: *BNC Male/Female Connector:* fully insulated nylon housing; nickel-plated brass body, gold/nickel plated brass center contact; polyethylene dielectric; *Coaxial Cable:* RG58, 50 ohm

****Length:** -12" (.3m), 24" (.6m), 36" (.9m), 48" (1.2m), 60" (1.5m)

Rating: Hands free testing at 500 VRMS on center conductor



Insulated Alligator Clips to BNC Male With RG58

Model# BU-5030-C-**-0

Insulated Alligator Clips to BNC Male With RG174

Model# BU-5330-F-**-0

Material: *Alligator Clip:* nickel-plated steel with PVC insulator; *BNC Male Connector:* MIL-C-39012, gold-plated center contact and silver-plated body (RG174/U BNC is a commercial connector with nickel-plated body); *Coaxial Cable:* shielded RG58C/U, MIL-C-17F, 50 ohm or shielded RG174/U, MIL-C-17D, 50 ohm

****Length:** -12" (.3m), 24" (.6m), 36" (.9m), 48" (1.2m), 60" (1.5m)

Rating: Hands free testing at 300 VRMS on center conductor



BNC Male Breakout to Tinned End Wires

Model# BU-5100-A-4-0

Material: *BNC Male Connector:* quality tarnish-resistant, plated brass with a gold-plated brass center contact, ABS housing; *Hook-up Wire:* #20 AWG (41/36) tinned copper with 105°C PVC insulation

Rating: Hands free testing at 300 VRMS on center conductor



BNC Male Breakout to Mini-Micro-Grabbers

Model# BU-5114-A-4-0

Material: *BNC Male Connector:* quality tarnish-resistant, plated brass with a gold-plated brass center contact, ABS housing; *Mini-Micro-Grabbers* (No.208) conductor and abrasion resistant, nylon housing; *Hook-up Wire:* #20 AWG (41/36) tinned copper with 105°C PVC insulation

Rating: Hands free testing at 150 VRMS, 5 Amp

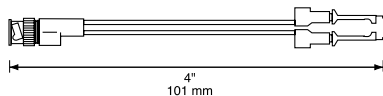

BNC Male Breakout to Stackable Single Banana Plugs

Model# BU-5120-A-4-0

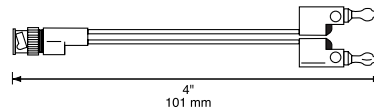

Material: *BNC Male Connector:* quality tarnish-resistant, plated brass with a gold-plated brass center contact, ABS housing; *Banana Plug:* premium nine-leaf, nickel-plated beryllium copper springs and copper alloy 360 bodies for minimum stacked in multiples, ABS housing; *Hook-up Wire:* #20 AWG (41/36) tinned copper with 105°C PVC insulation

Rating: Hands free testing at 300 VRMS, 5 Amp

BNC Male Breakout to Insulated Mini-Alligator Clips

Model# BU-5131-A-4-0

Material: *BNC Male Connector:* quality tarnish-resistant, plated brass with a gold-plated brass center contact, ABS housing; *Clip:* Mueller No. 30BL with No. 31 insulators; *Hook-up Wire:* #20 AWG (41/36) tinned copper with 105°C PVC insulation

Rating: Hands free testing at 300 VRMS, 10 Amp



BNC Male Breakout to Stackable 0.080" (2.0mm) Pin Plugs

Model# BU-5144-A-4-0

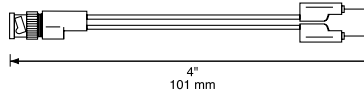

Material: *BNC Male Connector:* quality tarnish-resistant, plated brass with a gold-plated brass center contact, ABS housing; *Pin Tip:* nickel-plated brass 0.080" (2.0mm) dia; 0.500" (12.7mm) long; *Tip Jack:* Accepts 0.080" (2.0mm) dia. pin, nickel-plated, alloy 360 copper body; *Hook-up Wire:* #20 AWG (41/36) tinned copper with 105°C PVC insulation

Rating: Hands free testing at 300 VRMS, 5 Amps

BNC Female Breakout Style to Tinned End Wires

Model# BU-5200-A-4-0

Material: *BNC Female Connector:* quality tarnish-resistant, plated brass with a gold-plated brass center contact, ABS housing; *Hook-up Wire:* #20 AWG (41/36) tinned copper with 105°C PVC insulation

Rating: Hands free testing at 300 VRMS, 5 Amp



BNC Female Breakout to Insulated Mini-Alligator Clips

Model# BU-5231-A-4-0

Material: *BNC Female Connector:* quality tarnish-resistant, plated brass with a gold-plated brass center contact, ABS housing; *Clip:* Mueller No. 30BL with No. 31 insulators; *Hook-up Wire:* #20 AWG (41/36) tinned copper with 105°C PVC insulation

Rating: Hands free testing at 300 VRMS, 5 Amp



BNC Female Breakout to Mini-Micro-Grabbers

Model# BU-5214-A-4-0

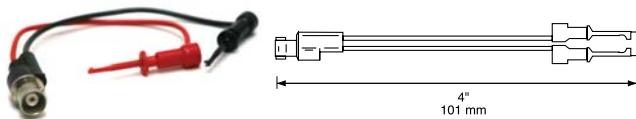

Material: *BNC Female Connector:* quality tarnish-resistant, plated brass with a gold-plated brass center contact, ABS housing; *Mini-Micro-Grabbers (No.208):* conductor and abrasion resistant, nylon housing; *Hook-up Wire:* #20 AWG (41/36) tinned copper with 105°C PVC insulation

Rating: Hands free testing at 300 VRMS, 5 Amp

BNC Female Breakout to Stackable 0.080" (2.0mm) Pin Plugs

Model# BU-5244-A-4-0

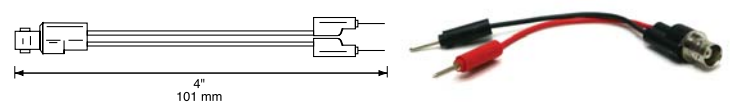

Material: *BNC Female Connector:* quality tarnish-resistant, plated brass with a gold-plated brass center contact, ABS housing; *Pin Tip:* nickel-plated brass 0.080" (2.0mm) dia; 0.500" (12.7mm) long; *Tip Jack:* accepts 0.080" (2.0mm) dia. pin, nickel-plated, alloy 360 copper body; *Hook-up Wire:* #20 AWG (41/36) tinned copper with 105°C PVC insulation

Rating: Hands free testing at 300 VRMS, 5 Amps

BNC Female Breakout to Stackable Single Banana Plugs

Model# BU-5220-A-4-0

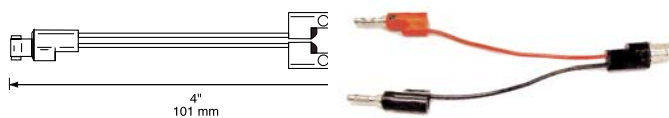

Material: *BNC Female Connector:* quality tarnish-resistant, plated brass with a gold-plated brass center contact, ABS housing; *Banana Plug:* premium nine-leaf, nickel-plated beryllium copper springs and copper alloy 360 bodies for minimum stacked in multiples, ABS housing; *Hook-up Wire:* #20 AWG (41/36) tinned copper with 105°C PVC insulation

Rating: Hands free testing at 300 VRMS, 10 Amps

Mini-Micro-Plunger to BNC Male

Model# BU-1450-C-**-0

Material: *BNC Male Connector:* MIL-C-39012, gold-plated center contact and silver-plated body; *Coaxial Cable:* shielded RG58C/U, MIL-C-17F, 50 ohm; *Plunger:* nylon housing, stainless steel spring and beryllium copper contact

****Length:** -12" (.3m), 24" (.6m), 36" (.9m), 48" (1.2m), 60" (1.5m)

Rating: Hands free testing at 300 VRMS on center conductor



Mueller DMM kits are designed for compatibility with Fluke, Agilent, Tektronix, and other DMM manufacturers. Reference page 28 for a Meter-Mate™ meter-to-accessory cross-reference table.



Order Key					
BU-0000-X-00-*					
Typical Mueller Part #		Type of wire		Color Length in inches	
Color Key			Available Test Lead Lengths		
0=Black	4=Yellow	6=Blue	6"	24"	48"
2=Red	5=Green	9=White	12"	36"	60"

400002 (34000 Series Bench DMM Meter Mate Kit)

34000 Series Bench DMM's Meter Mate Kit has compatible replacement leads for all Agilent 34000 Series digital multimeters.

QTY	P/N	DESCRIPTION
1	PM-50000	Blue tri-fold bag
1	Box 3	Retail Packaging Box
1	PM-1000	Compatibility Label
1	BU-6162-M-60-0	TL, banana-to-right angle banana, silicone, 60", 1kV, 20 Amp, black
1	BU-6162-M-60-2	TL, banana-to-right angle banana, silicone, 60", 1kV, 20 Amp, red
1	BU-26106-0	Test Probe, banana, 1kV, 20 Amp, black
1	BU-26106-2	Test Probe, banana, 1kV, 20 Amp, red
1	BU-65-0	Clip, insulated, banana, 1kV, 30 Amp, black
1	BU-65-2	Clip, insulated, banana, 1kV, 30 Amp, red
1	BU-20431-0	Insulated plunger hook, mini grip, 1kV, 3 Amp, black
1	BU-20431-2	Insulated plunger hook, mini grip, 1kV, 3 Amp, red
1	BU-00207-0	Threaded plunger, 1kV, 15 Amps, black
1	BU-00207-2	Threaded plunger, 1kV, 15 Amps, red
1	BU-26130-0	Ultra Tech Test Prod, 1kV, 15 Amp, black
1	BU-26130-2	Ultra Tech Test Prod, 1kV, 15 Amp, red
1	BU-30212-0	Insulated spade lug, black
1	BU-30212-2	Insulated spade lug, red
1	BU-32101-0	Banana Adapter, 1kV, 15 Amp, black
1	BU-32101-2	Banana Adapter, 1kV, 15 Amp, red

