



Chipsmall Limited consists of a professional team with an average of over 10 year of expertise in the distribution of electronic components. Based in Hongkong, we have already established firm and mutual-benefit business relationships with customers from,Europe,America and south Asia,supplying obsolete and hard-to-find components to meet their specific needs.

With the principle of “Quality Parts,Customers Priority,Honest Operation,and Considerate Service”,our business mainly focus on the distribution of electronic components. Line cards we deal with include Microchip,ALPS,ROHM,Xilinx,Pulse,ON,Everlight and Freescale. Main products comprise IC,Modules,Potentiometer,IC Socket,Relay,Connector.Our parts cover such applications as commercial,industrial, and automotives areas.

We are looking forward to setting up business relationship with you and hope to provide you with the best service and solution. Let us make a better world for our industry!



Contact us

Tel: +86-755-8981 8866 Fax: +86-755-8427 6832

Email & Skype: info@chipsmall.com Web: www.chipsmall.com

Address: A1208, Overseas Decoration Building, #122 Zhenhua RD., Futian, Shenzhen, China



High-performance Clock Generator Series

DVD-audio Reference

Clock Generators for A/V Equipments



BU2285FV, BU2363FV

No.09005EAT03

●Description

These clock generators are an IC generating three types of clocks - VIDEO, AUDIO and SYSTEM clocks – necessary for DVD player systems, with a single chip through making use of the PLL technology. Particularly, the VIDEO clock is a DVD-Audio reference and yet achieves high C/N characteristics necessary to provide high definition images.

●Features

- 1) Connecting a crystal oscillator generates multiple clock signals with a built-in PLL.
- 2) The AUDIO clock provides switching selection outputs
- 3) The VIDEO clock achieves high C/N characteristics.
- 4) Single power supply of 3.3 V

●Applications

DVD players

●Line up matrix

Part name		BU2285FV	BU2363FV	
Supply voltage [V]		3.0 ~ 3.6	3.0 ~ 3.6	
Reference frequency [MHz]		36.8640	36.8640	
Output frequency [MHz]	DVD VIDEO	2	54.0000	
		1	27.0000	
		1/2	13.5000	
	DVD / CD AUDIO (Switching outputs)	768fs	36.8640 / 33.8688	36.8640 / 33.8688
		512fs	—	—
		384fs	18.4320 / 16.9344	18.4320 / 16.9344
		256fs	—	—
	SYSTEM	768fs	33.8688	33.8688
384fs		16.9344	16.9344	
Jitter 1 σ [psec]		50	50	
C/N [dB] (VIDEO)		-60	-80	
Package		SSOP-B24	SSOP-B16	

●Absolute Maximum Ratings (Ta=25°C)

Parameter	Symbol	BU2285FV	BU2363FV	Unit
Supply voltage	VDD	-0.5 ~ +7.0	-0.5 ~ +7.0	V
Input voltage	VIN	-0.5 ~ VDD+0.5	-0.5 ~ VDD+0.5	V
Storage temperature range	T _{stg}	-30 ~ +125	-30 ~ +125	°C
Power dissipation	PD	630 ^{*1}	450 ^{*2}	mW

*1 In the case of exceeding at Ta = 25°C, 6.3mW should be reduced per 1°C

*2 In the case of exceeding at Ta = 25°C, 4.5mW should be reduced per 1°C

*Operating is not guaranteed.

*The radiation-resistance design is not carried out.

*Power dissipation is measured when the IC is mounted to the printed circuit board.

●Recommended Operating Range

Parameter	Symbol	BU2285FV	BU2363FV	Unit
Supply voltage	VDD	3.0 ~ 3.6	3.0 ~ 3.6	V
Input H voltage	VIH	0.8VDD ~ VDD	0.8VDD ~ VDD	V
Input L voltage	VIL	0.0 ~ 0.2VDD	0.0 ~ 0.2VDD	V
Operating temperature	T _{opr}	-5 ~ +70	-10 ~ +70	°C
Maximum output load	CL	15	15	pF

●Electrical characteristics

©BU2285FV(VDD=3.3V, Ta=25°C, Crystal frequency 36.8640MHz, unless otherwise specified.)

Parameter	Symbol	Limits			Unit	Conditions
		Min.	Typ.	Max.		
Output L voltage	VOL	—	—	0.4	V	IOL=4.0mA
Output H voltage	VOH	2.4	—	—	V	IOH=-4.0mA
Consumption current	IDD	—	30	50	mA	At no load
CLK54M	CLK54M	—	54.0000	—	MHz	XTAL × 375 / 128 / 2
CLK27M	CLK27M	—	27.0000	—	MHz	XTAL × 375 / 128 / 4
CLKDAC	CLKDAC_H	—	27.0000	—	MHz	At CTRLB=OPEN, XTAL × 375 / 128 / 4
	CLKDAC_L	—	13.5000	—	MHz	At CTRLB=L, XTAL × 375 / 128 / 8
CLK33M	CLK33M	—	33.8688	—	MHz	XTAL × 147 / 40 / 4
CLK16M	CLK16M	—	16.9344	—	MHz	XTAL × 147 / 40 / 8
CLKA	CLKA_H	—	36.8640	—	MHz	At CTRLA=OPEN, XTAL output
	CLKA_L	—	33.8688	—	MHz	At CTRLA=L, XTAL × 147 / 40 / 4
CLKB	CLKB_H	—	18.4320	—	MHz	At CTRLA=OPEN, XTAL / 2 output
	CLKB_L	—	16.9344	—	MHz	At CTRLA=L, XTAL × 147 / 40 / 8
Duty	Duty	45	50	55	%	Measured at a voltage of 1/2VDD
Period-Jitter 1σ	P-J 1σ	—	50	—	psec	*1
Period-Jitter MIN-MAX	P-J MIN-MAX	—	300	—	psec	*2
Rise Time	Tr	—	2.5	—	nsec	Period of transition time required for the clock output to reach 80% from 20% of VDD
Fall Time	Tf	—	2.5	—	nsec	Period of transition time required for the clock output to reach 20% from 80% of VDD
Output Lock-Time	Tlock	—	—	1	msec	*3

Note) The output frequency is determined by the arithmetic (frequency division) expression of a frequency input to XTALIN.
If the input frequency is set to 36.8640MHz, the output frequency will be as listed above.

©BU2363FV(VDD=3.3V, Ta=25°C, Crystal frequency 36.8640MHz, unless otherwise specified.)

Parameter	Symbol	Limits			Unit	Conditions
		Min.	Typ.	Max.		
Output L voltage	VOL	—	—	0.4	V	IOL=4.0mA
Output H voltage	VOH	2.4	—	—	V	IOH=−4.0mA
Consumption current	IDD	—	30	50	mA	At no load
CLK54M	CLK54M	—	54.0000	—	MHz	XTAL × 375 / 64 / 4
CLK27M	CLK27M	—	27.0000	—	MHz	XTAL × 375 / 64 / 8
CLK33M	CLK33M	—	33.8688	—	MHz	XTAL × 147 / 40 / 4
CLK16M	CLK16M	—	16.9344	—	MHz	XTAL × 147 / 40 / 8
CLK768FS1	CLK768_H	—	36.8640	—	MHz	At FSEL=OPEN, XTAL output
	CLK768_L	—	33.8688	—	MHz	At FSEL=L, XTAL × 147 / 40 / 4
CLK384FS2	CLK384_H	—	18.4320	—	MHz	At FSEL=OPEN, XTAL / 2 output
	CLK384_L	—	16.9344	—	MHz	At FSEL=L, XTAL × 147 / 40 / 8
Duty	Duty	45	50	55	%	Measured at a voltage of 1/2VDD
Period-Jitter 1σ	P-J 1σ	—	50	—	psec	*1
Period-Jitter MIN-MAX	P-J MIN-MAX	—	300	—	psec	*2
Rise Time	Tr	—	2.5	—	nsec	Period of transition time required for the clock output to reach 80% from 20% of VDD
Fall Time	Tf	—	2.5	—	nsec	Period of transition time required for the clock output to reach 20% from 80% of VDD
Output Lock-Time	Tlock	—	—	1	msec	*3
C/N 54M	C/N 54M	-65	-80	—	dB	*4 (At a maximum load)
C/N 33M	C/N 33M	-50	-60	—	dB	*4 (At a maximum load)

Note) The output frequency is determined by the arithmetic (frequency division) expression of a frequency input to XTALIN.
If the input frequency is set to 36.8640MHz, the output frequency will be as listed above.

Common to BU2285FV and BU2363FV:

*1 Period-Jitter 1σ

This parameter represents standard deviation (=1 σ) on cycle distribution data at the time when the output clock cycles are sampled 1000 times consecutively with the TDS7104 Digital Phosphor Oscilloscope of Tektronix Japan, Ltd.

*2 Period-Jitter MIN-MAX

This parameter represents a maximum distribution width on cycle distribution data at the time when the output clock cycles are sampled 1000 times consecutively with the TDS7104 Digital Phosphor Oscilloscope of Tektronix Japan, Ltd.

*3 Output Lock-Time

The Lock-Time represents elapsed time after power supply turns ON to reach a 3.0V voltage, after the system is switched from Power-Down state to normal operation state, or after the output frequency is switched, until it is stabilized at a specified frequency, respectively.

BU2363FV

*4 Make measurements with settings of SPAN to 100kHz, RBW to 1kHz, and VBW to 100Hz taking the middle point between (54.0000MHz±20kHz) and (33.8688MHz±20kHz) as a measurement point.

●Reference data (BU2285FV basic data)

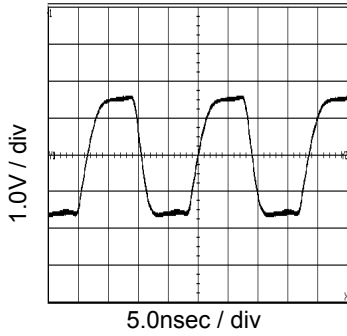

Fig.1 54MHz output waveform
VDD=3.3V, at CL=15pF

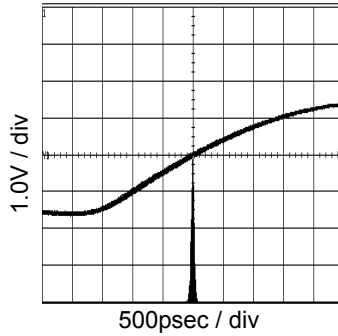

Fig.2 54MHz Period-Jitter
VDD=3.3V, at CL=15pF

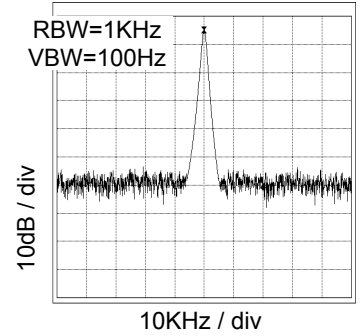

Fig.3 54MHz Spectrum
VDD=3.3V, at CL=15pF

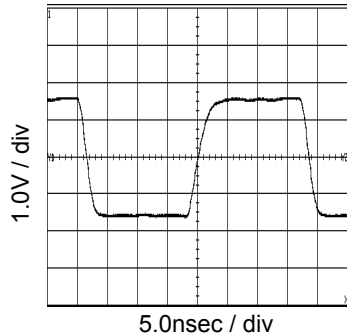

Fig.4 27MHz output waveform
VDD=3.3V, at CL=15pF

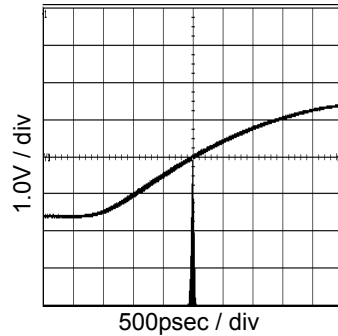

Fig.5 27MHz Period-Jitter
VDD=3.3V, at CL=15pF

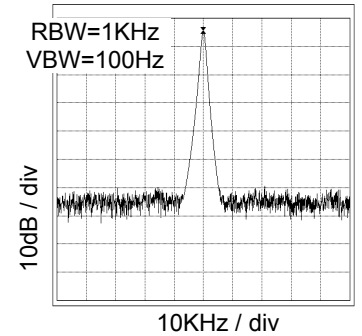

Fig.6 27MHz Spectrum
VDD=3.3V at CL=15pF

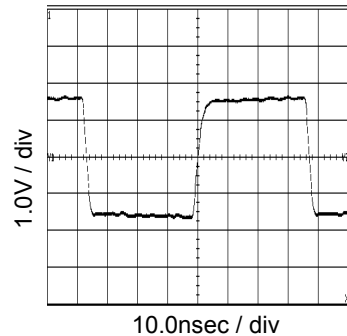

Fig.7 13.5MHz output waveform
VDD=3.3V, at CL=15pF

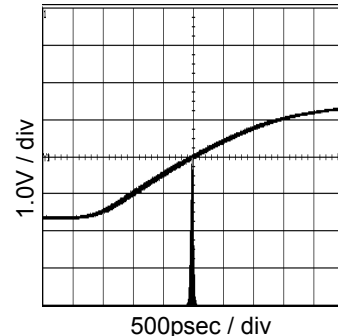

Fig.8 13.5MHz Period-Jitter
VDD=3.3V, at CL=15pF

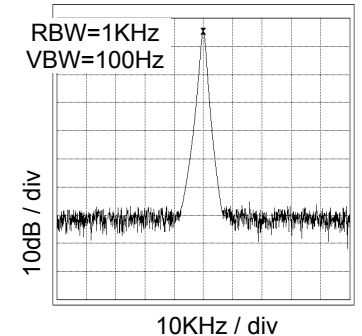

Fig.9 13.5MHz Spectrum
VDD=3.3V, at CL=15pF

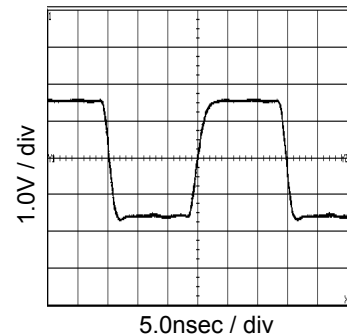

Fig.10 33.9MHz output waveform
VDD=3.3V, at CL=15pF

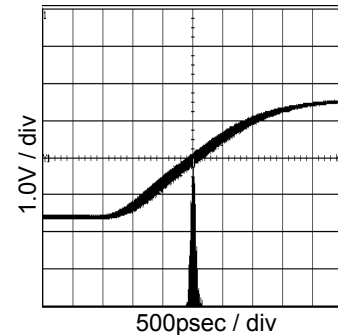

Fig.11 33.9MHz Period-Jitter
VDD=3.3V, at CL=15pF

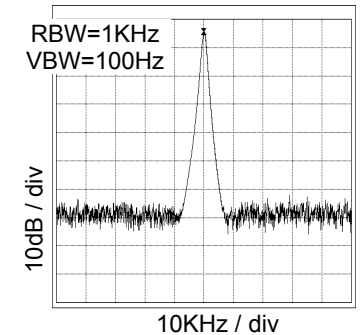

Fig.12 33.9MHz Spectrum
VDD=3.3V, at CL=15pF

●Reference data (BU2285FV basic data)

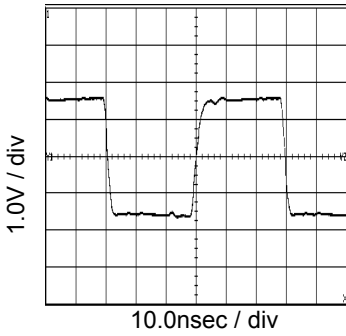

Fig.13 16.9MHz output waveform
VDD=3.3V, at CL=15pF

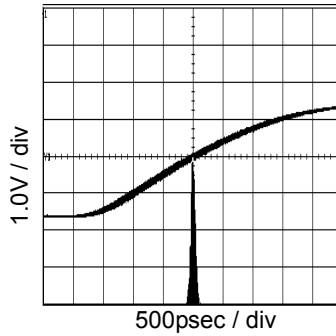

Fig.14 16.9MHz Period-Jitter
VDD=3.3V, at CL=15pF

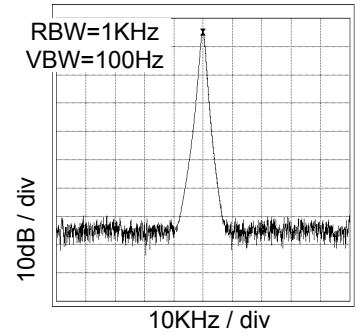

Fig.15 16.9MHz Spectrum
VDD=3.3V, at CL=15pF

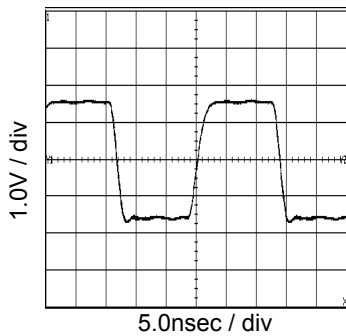

Fig.16 36.9MHz output waveform
VDD=3.3V, at CL=15pF

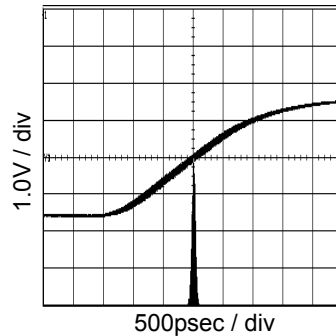

Fig.17 36.9MHz Period-Jitter
VDD=3.3V, at CL=15pF

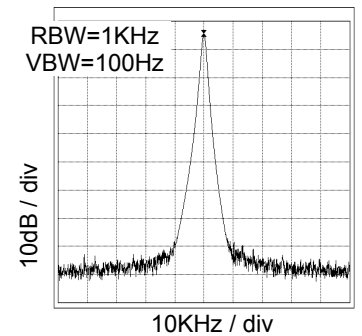

Fig.18 36.9MHz Spectrum
VDD=3.3V, at CL=15pF

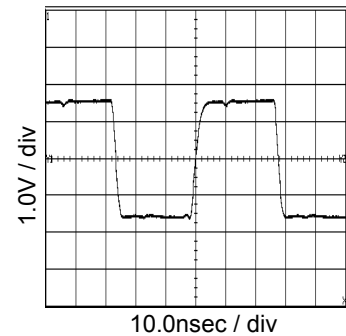

Fig.19 18.4MHz output waveform
VDD=3.3V, at CL=15pF

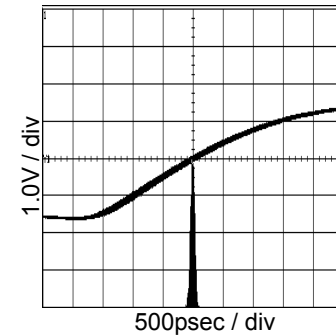

Fig.20 18.4MHz Period-Jitter
VDD=3.3V, at CL=15pF

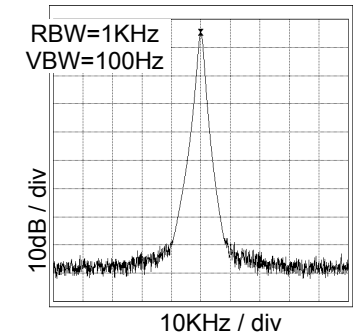

Fig.21 18.4MHz Spectrum
VDD=3.3V, at CL=15pF

●Reference data (BU2285FV Temperature and Supply voltage variations data)

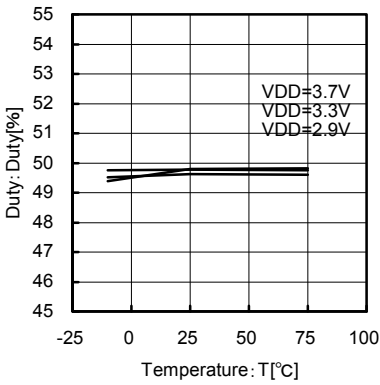

Fig.22 54MHz
Temperature - Duty

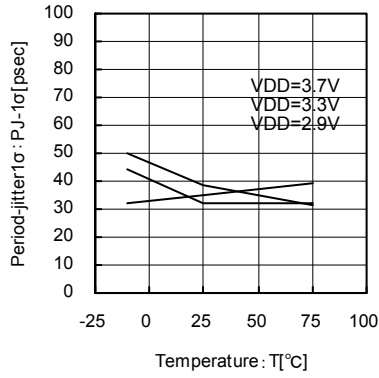

Fig.23 54MHz
Temperature - Period-Jitter 1σ

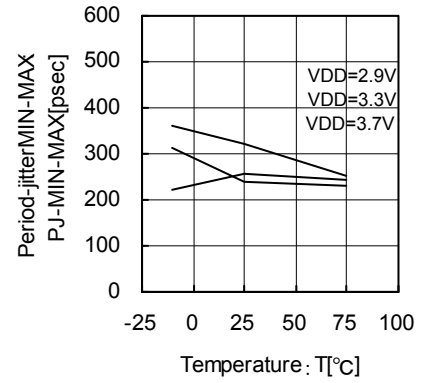

Fig.24 54MHz
Temperature - Period-Jitter MIN-MAX

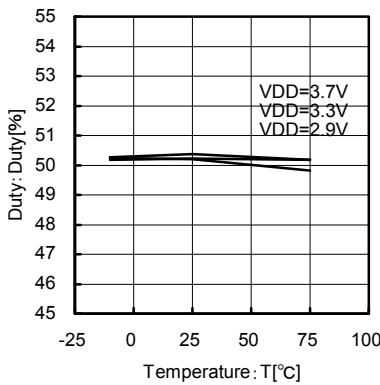

Fig.25 27MHz
Temperature - Duty

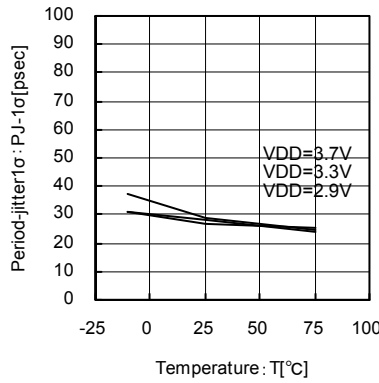

Fig.26 27MHz
Temperature - Period-Jitter 1σ

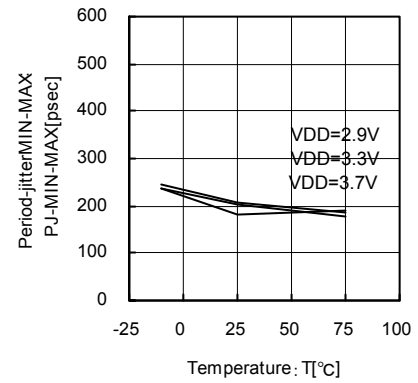

Fig.27 27MHz
Temperature - Period-Jitter MIN-MAX

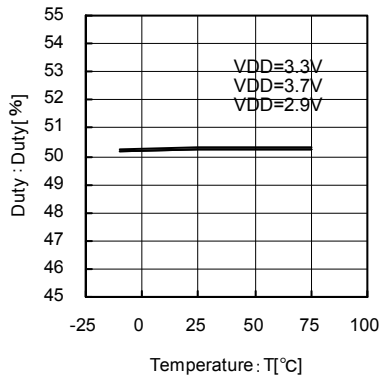

Fig.28 13.5MHz
Temperature - Duty

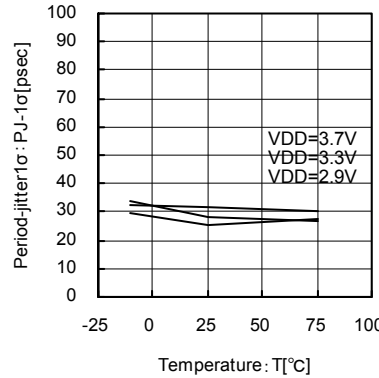

Fig.29 13.5MHz
Temperature - Period-Jitter 1σ

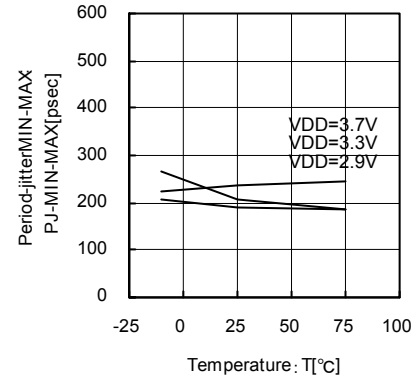

Fig.30 13.5MHz
Temperature - Period-Jitter MIN-MAX

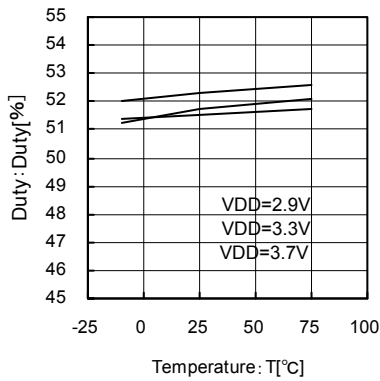

Fig.31 33.9MHz
Temperature - Duty

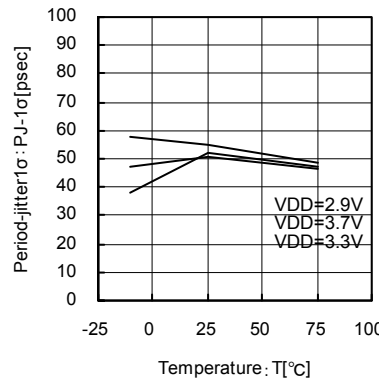

Fig.32 33.9MHz
Temperature - Period-Jitter 1σ

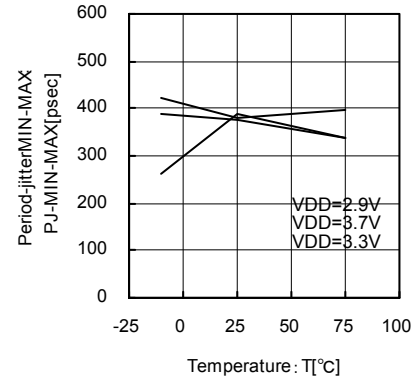

Fig.33 33.9MHz
Temperature - Period-Jitter MIN-MAX

●Reference data (BU2285FV Temperature and Supply voltage variations data)

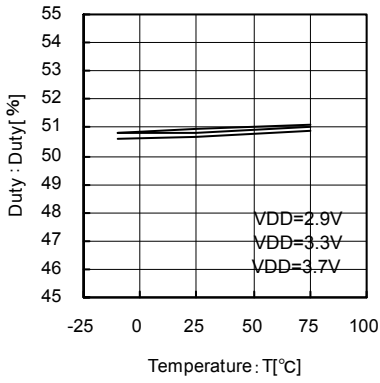

Fig.34 16.9MHz
Temperature - Duty

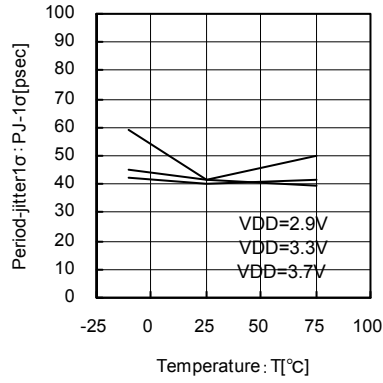

Fig.35 16.9MHz
Temperature - Period-Jitter 1σ

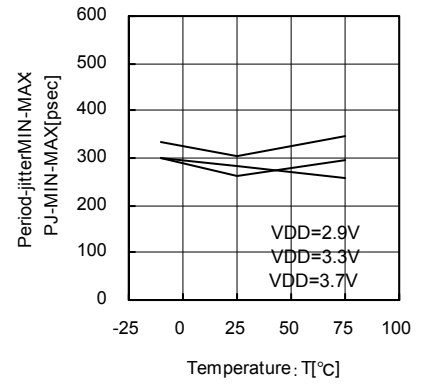

Fig.36 16.9MHz
Temperature - Period-Jitter MIN-MAX

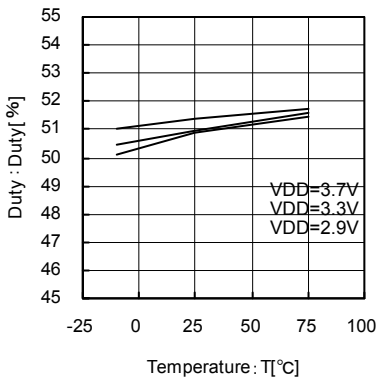

Fig.37 36.9MHz
Temperature - Duty

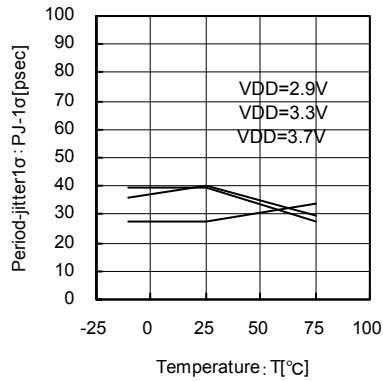

Fig.38 36.9MHz
Temperature - Period-Jitter 1σ

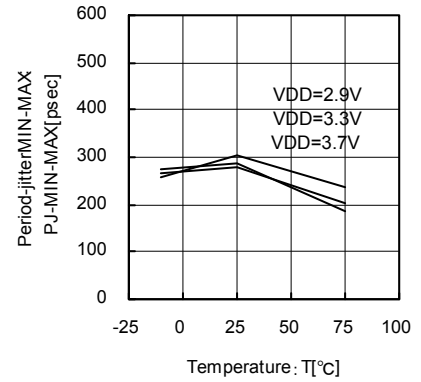

Fig.39 36.9MHz
Temperature - Period-Jitter MIN-MAX

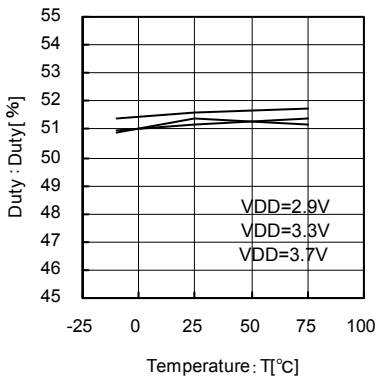

Fig.40 18.4MHz
Temperature - Duty

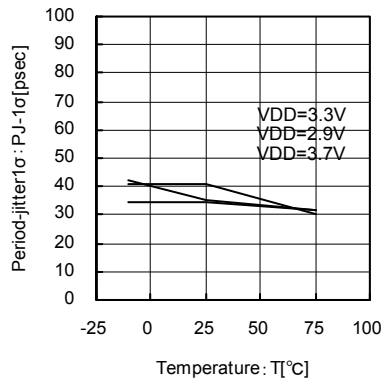

Fig.41 18.4MHz
Temperature - Period-Jitter 1σ

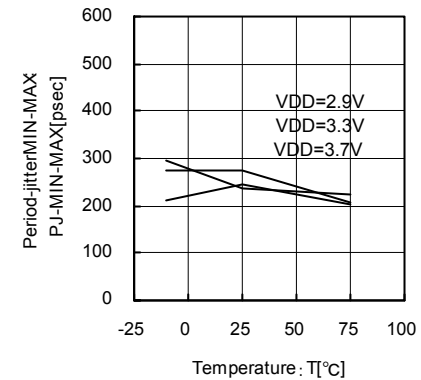

Fig.42 18.4MHz
Temperature - Period-Jitter MIN-MAX

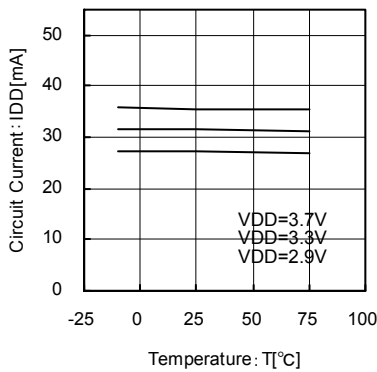

Fig.43 Consumption current
(with maximum output load)
Temperature - Consumption current

●Reference data (BU2363FV basic data)

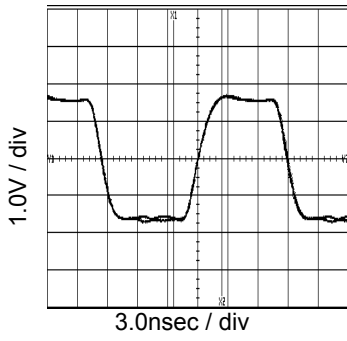

Fig.44 54MHz output waveform
VDD=3.3V, at CL=15pF

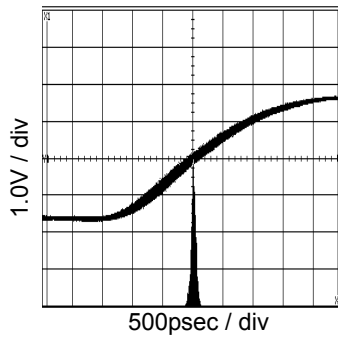

Fig.45 54MHz Period-Jitter
VDD=3.3V, at CL=15pF

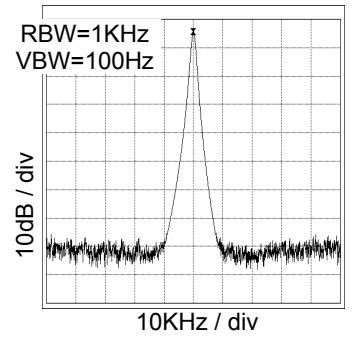

Fig.46 54MHz Spectrum
VDD=3.3V, at CL=15pF

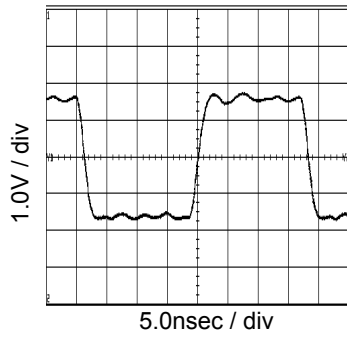

Fig.47 27MHz output waveform
VDD=3.3V, at CL=15pF

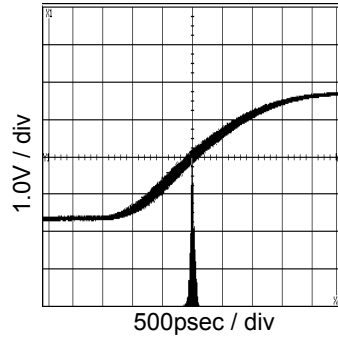

Fig.48 27MHz Period-Jitter
VDD=3.3V, at CL=15pF

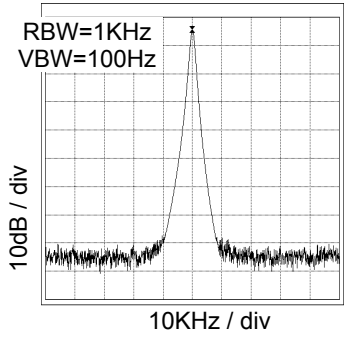

Fig.49 27MHz Spectrum
VDD=3.3V, at CL=15pF

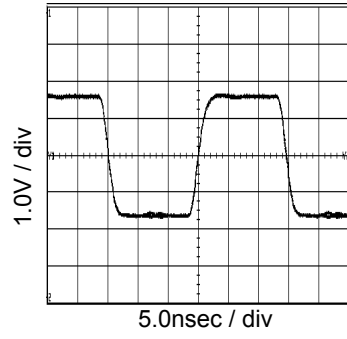

Fig.50 33.9MHz output waveform
VDD=3.3V, at CL=15pF

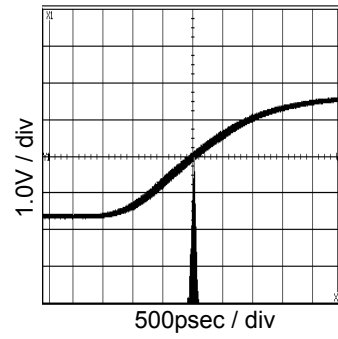

Fig.51 33.9MHz Period-Jitter
VDD=3.3V, at CL=15pF

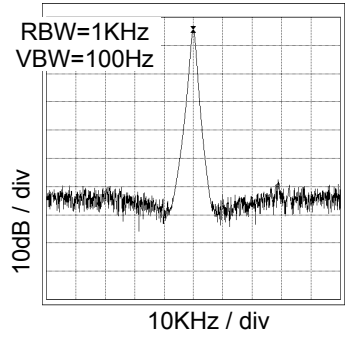

Fig.52 33.9MHz Spectrum
VDD=3.3V, at CL=15pF

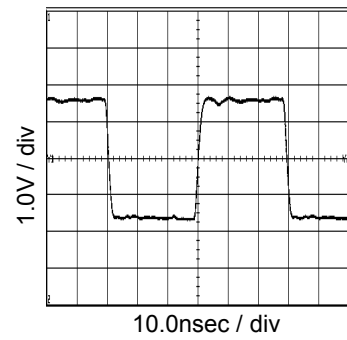

Fig.53 16.9MHz output waveform
VDD=3.3V, at CL=15pF

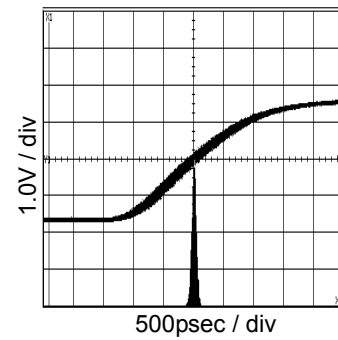

Fig.54 16.9MHz Period-Jitter
VDD=3.3V, at CL=15pF

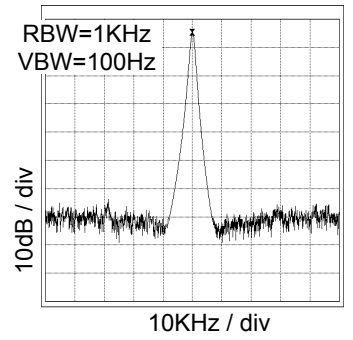

Fig.55 16.9MHz Spectrum
VDD=3.3V, at CL=15pF

●Reference data (BU2363FV basic data)

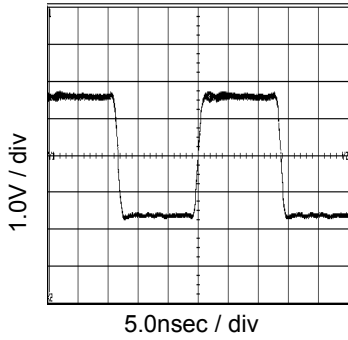

Fig.56 36.9MHz output waveform
VDD=3.3V, at CL=15pF

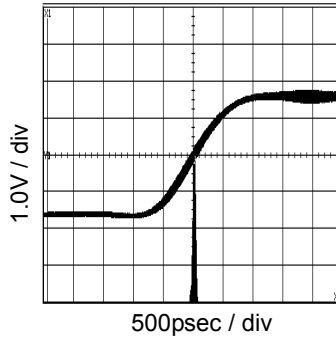

Fig.57 36.9MHz Period-Jitter
VDD=3.3V, at CL=15pF

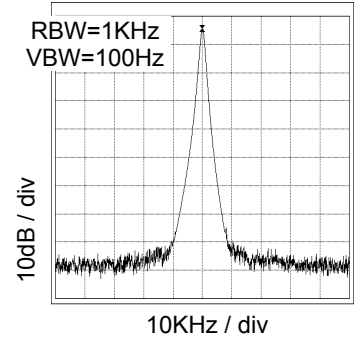

Fig.58 36.9MHz Spectrum
VDD=3.3V, at CL=15pF

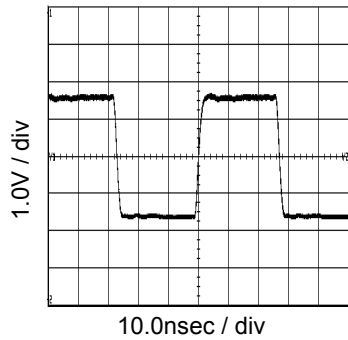

Fig.59 18.4MHz output waveform
VDD=3.3V, at CL=15pF

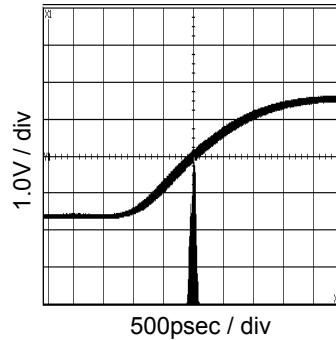

Fig.60 18.4MHz Period-Jitter
VDD=3.3V, at CL=15pF

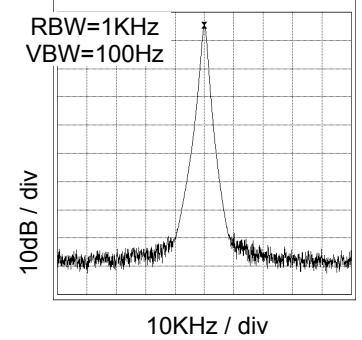

Fig.61 18.4MHz Spectrum
VDD=3.3V, at CL=15pF

●Reference data (BU2363FV Temperature and Supply voltage variations data)

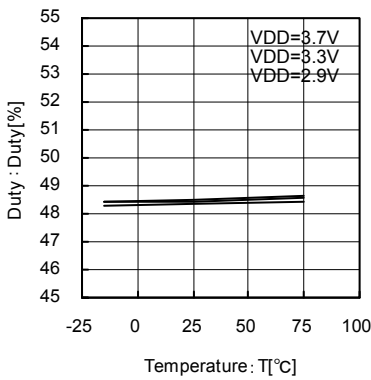

Fig.62 54MHz
Temperature - Duty

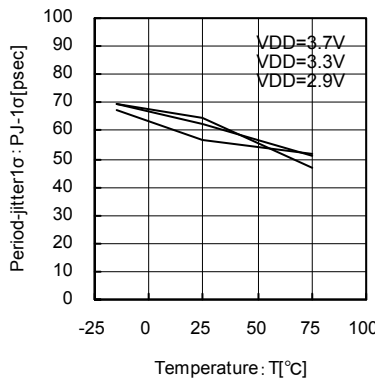

Fig.63 54MHz
Temperature - Period-Jitter 1σ

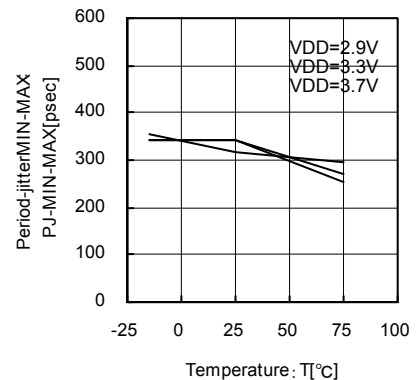

Fig.64 54MHz
Temperature - Period-Jitter MIN-MAX

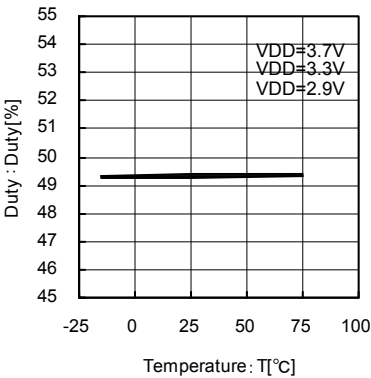

Fig.65 27MHz
Temperature - Duty

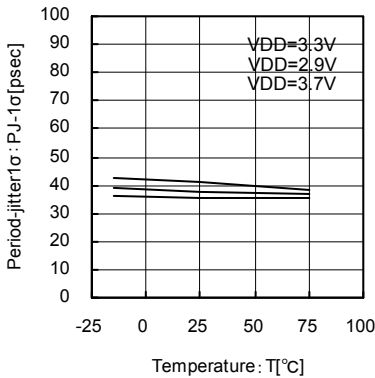

Fig.66 27MHz
Temperature - Period-Jitter 1σ

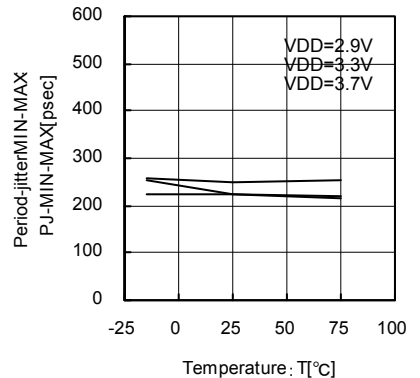

Fig.67 27MHz
Temperature - Period-Jitter MIN-MAX

●Reference data (BU2363FV Temperature and Supply voltage variations data)

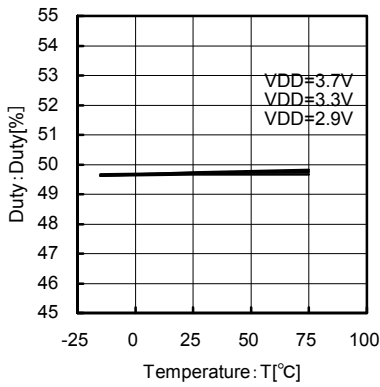

Fig.68 33.9MHz
Temperature - Duty

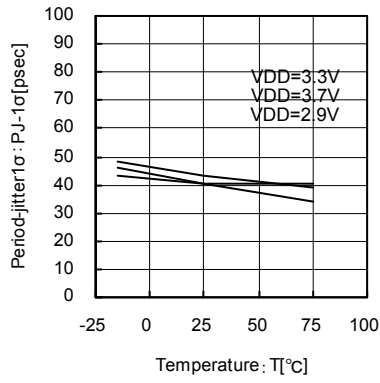

Fig.69 33.9MHz
Temperature - Period-Jitter 1σ

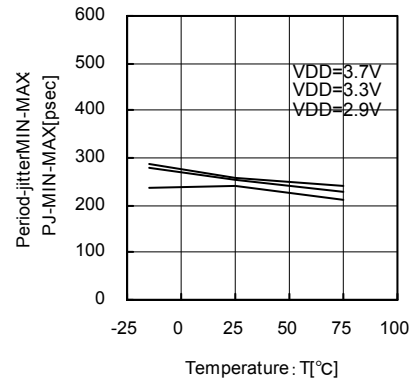

Fig.70 33.9MHz
Temperature - Period-Jitter MIN-MAX

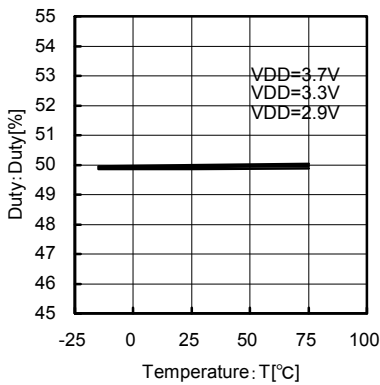

Fig.71 16.9MHz
Temperature - Duty

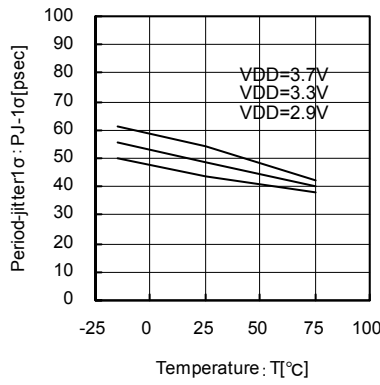

Fig.72 16.9MHz
Temperature - Period-Jitter 1σ

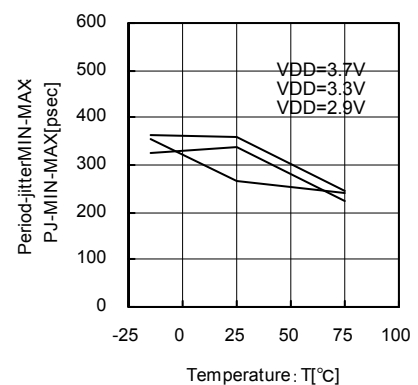

Fig.73 16.9MHz
Temperature - Period-Jitter

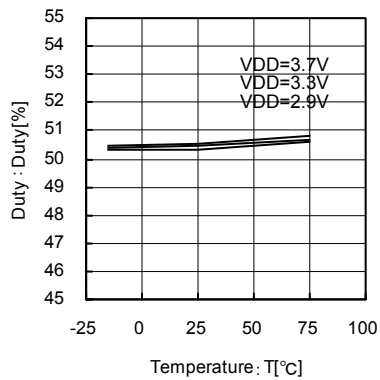

Fig.74 36.9MHz
Temperature - Duty

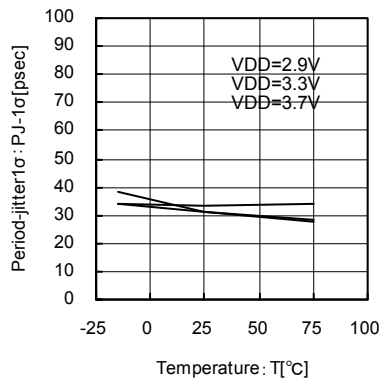

Fig.75 36.9MHz
Temperature - Period-Jitter 1σ

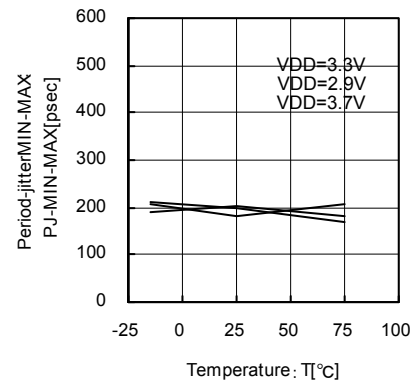

Fig.76 36.9MHz
Temperature - Period-Jitter MIN-MAX

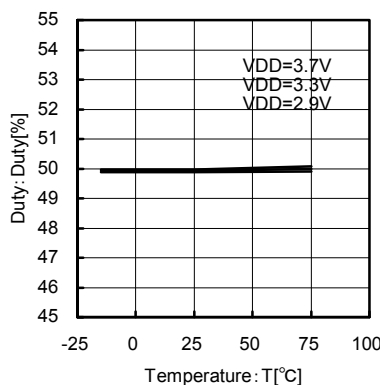

Fig.77 18.4MHz
Temperature - Duty

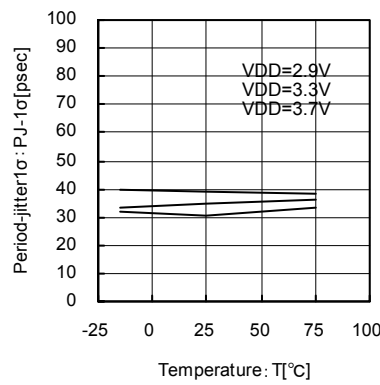

Fig.78 18.4MHz
Temperature - Period-Jitter 1σ

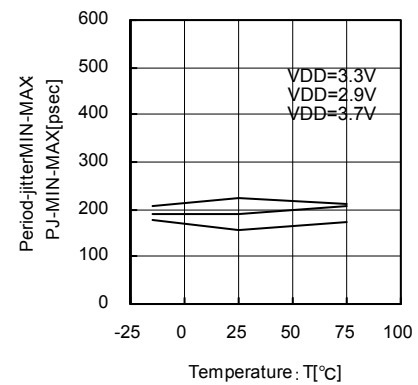

Fig.79 18.4MHz
Temperature - Period-Jitter

●Reference data (BU2363FV Temperature and Supply voltage variations data)

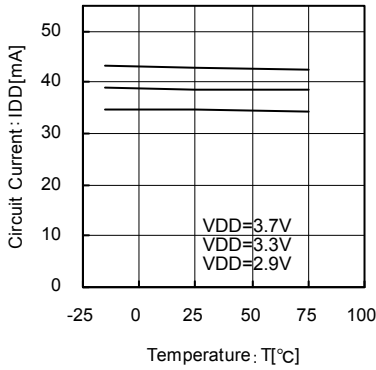

Fig.80 Consumption current (with maximum output load)

Temperature—Consumption current

●Block diagram, Pin assignment

©BU2285FV

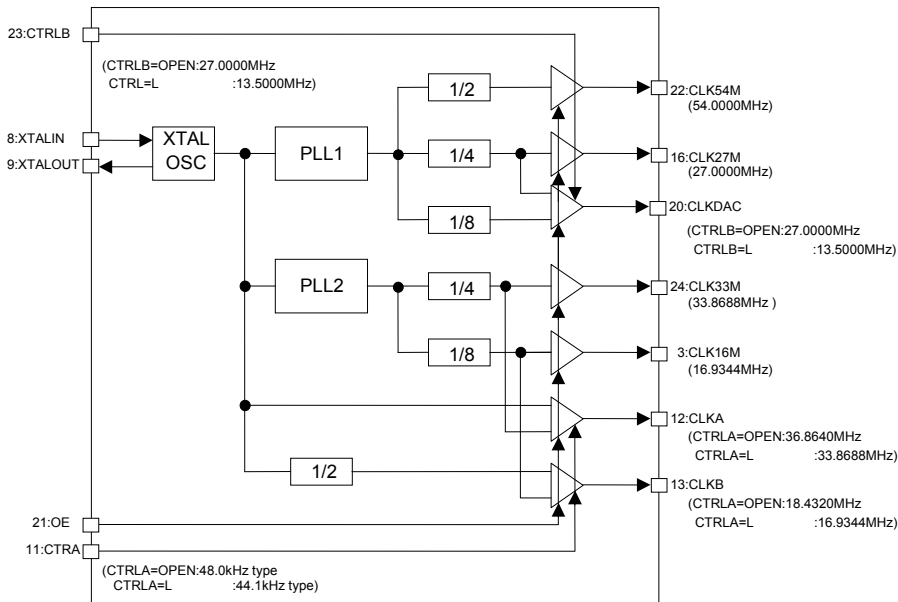

Fig.81

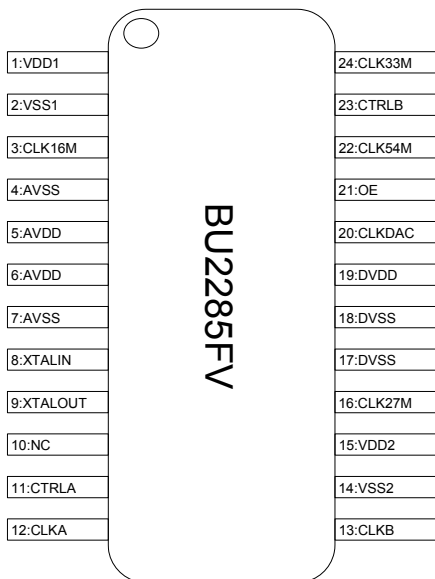

Fig.82

CTRLA	CLKA	CLKB
L	33.8688MHz	16.9344MHz
OPEN	36.8640MHz	18.4320MHz

CTRLB	CLKDAC
L	13.5000MHz
OPEN	27.0000MHz

●Block diagram, Pin assignment

©BU2363FV

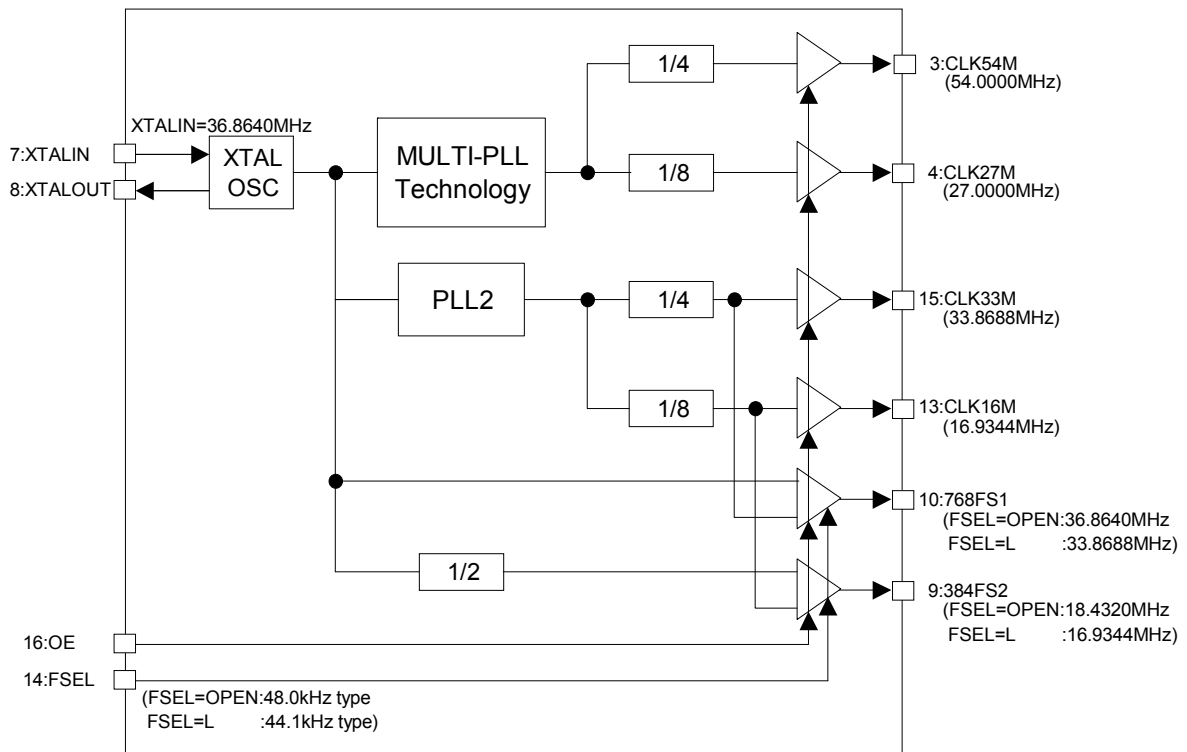

Fig.83



Fig.84

FSEL	CLK768FS	CLK384FS
L	33.8688MHz	16.9344MHz
OPEN	36.8640MHz	18.4320MHz

● Example of application circuit

©BU2285FV

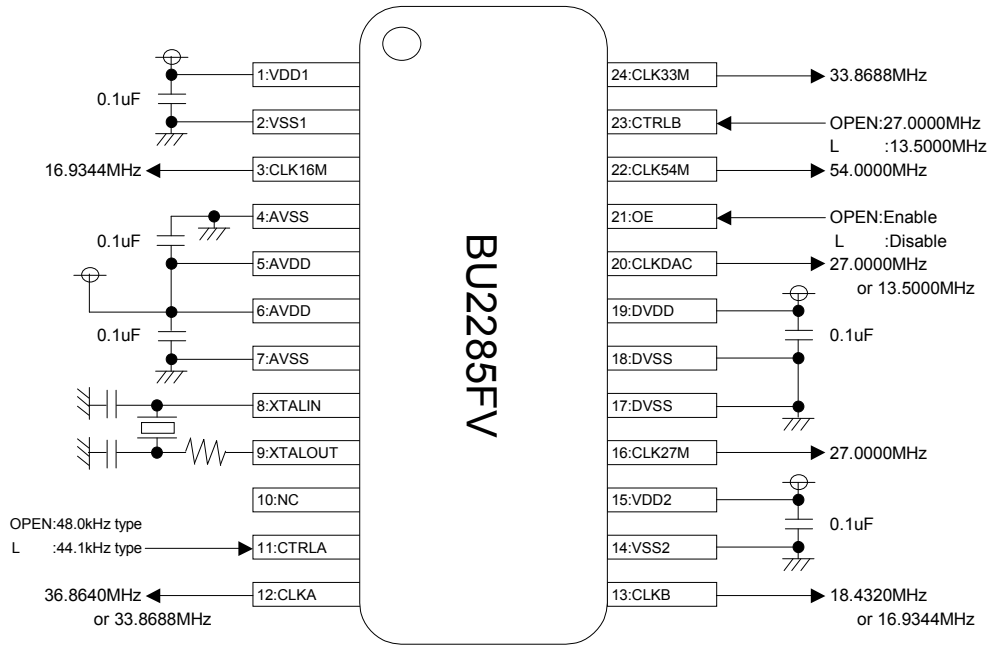

Fig.85

Pin Function

PIN No.	PIN Name	PIN Function
1	VDD1	33MHz system power supply
2	VSS1	33MHz system GND
3	CLK16M	16.9344MHz output
4	AVSS	Analog GND
5	AVDD	Analog power supply
6	AVDD	Analog power supply
7	AVSS	Analog GND
8	XTALIN	Crystal input terminal
9	XTALOUT	Crystal output terminal
10	NC	NC
11	CTRLA	CLKA or B output selection (with pull-up)
12	CLKA	CTRLA=OPEN:36.8640MHz, CTRLA=L:33.8688MHz
13	CLKB	CTRLA=OPEN:18.4320MHz, CTRLA=L:16.9344MHz
14	VSS2	CLKA, B GND
15	VDD2	CLKA, B power supply
16	CLK27M	27.0000MHz output
17	DVSS	Digital GND
18	DVSS	Digital GND
19	DVDD	Digital power supply
20	CLKDAC	CTRLB=OPEN:27.0000MHz, CTRLB=L:13.5000MHz
21	OE	Output enable (with pull-up), OPEN:enable, L:disable
22	CLK54M	54.0000MHz output
23	CTRLB	CLKDAC output selection(with pull-up)
24	CLK33M	33.8688MHz output

Note) Basically, mount ICs to the printed circuit board for use.

(If the ICs are not mounted to the printed circuit board, the characteristics of ICs may not be fully demonstrated.)

Mount 0.1μF capacitors in the vicinity of the IC PINs between 1PIN (VDD1) and 2PIN (VSS1), 4PIN (AVSS) and 5PIN (AVDD), 6PIN (AVDD) and 7PIN (AVSS), 14PIN (VSS2) and 15PIN (VDD2), and 17PIN/18PIN (DVSS) and 19PIN (DVDD), respectively.

Depending on the conditions of the printed circuit board, mount an additional electrolytic capacitor between the power supply and GND terminal.

For EMI protection, it is effective to put ferrite beads in the origin of power supply to be fed to BU2285FV from the printed circuit board or to insert a capacitor (of 1Ω or less), which bypasses high frequency desired, between the power supply and the GND terminal.

●Example of application circuit

©BU2363FV

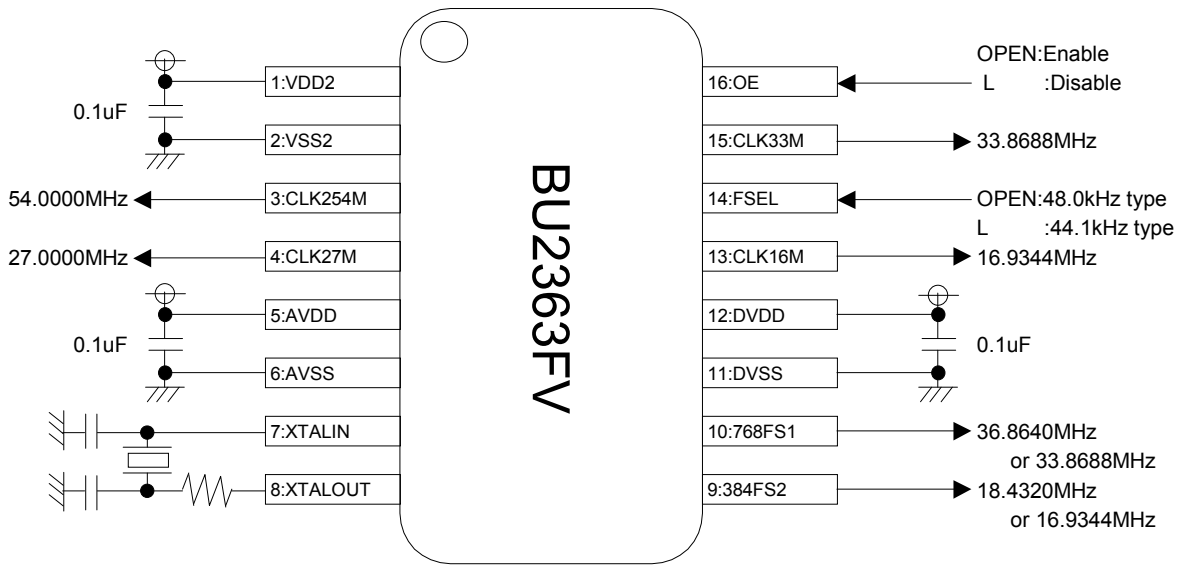

Fig.86

Pin Function

PIN No.	PIN Name	PIN Function
1	VDD2	27MHz, 54MHz power supply
2	VSS2	27MHz, 54MHzGND
3	CLK54M	54.0000MHz output
4	CLK27M	27.0000MHz output
5	AVDD	Analog power supply
6	AVSS	Analog GND
7	XTALIN	Crystal input terminal
8	XTALOUT	Crystal output terminal
9	384FS2	FSEL=OPEN:18.4320MHz, FSEL=L:16.9344MHz
10	768FS1	FSEL=OPEN:36.8640MHz, FSEL=L:33.8688MHz
11	DVSS	Digital GND
12	DVDD	Digital power supply
13	CLK16M	16.9344MHz output
14	FSEL	9, 10PIN output selection(with pull-up) OPEN:18.4320MHz(9PIN), 36.8640MHz(10PIN) L:16.9344MHz(9PIN), 33.8688MHz(10PIN)
15	CLK33M	33.8688MHz output
16	OE	Output enable (with pull-up), OPEN:enable, L:disable

Note) Basically, mount ICs to the printed circuit board for use.

(If the ICs are not mounted to the printed circuit board, the characteristics of ICs may not be fully demonstrated.)

Mount 0.1μF capacitors in the vicinity of the IC PINs between 1PIN (VDD2) and 2PIN (VSS2), 5PIN (AVDD) and 6PIN (AVSS), 11PIN (DVSS) and 12PIN (DVDD), respectively.

Depending on the conditions of the printed circuit board, mount an additional electrolytic capacitor between the power supply and GND terminal.

For EMI protection, it is effective to put ferrite beads in the origin of power supply to be fed to BU2363FV from the printed circuit board or to insert a capacitor (of 1Ω or less), which bypasses high frequency desired, between the power supply and the GND terminal.

Even though we believe that the example of recommended circuit is worth of a recommendation, please be sure to thoroughly recheck the characteristics before use.

●Notes for use

- (1) Absolute Maximum Ratings
An excess in the absolute maximum ratings, such as applied voltage (VDD or VIN), operating temperature range (Topr), etc., can break down devices, thus making impossible to identify breaking mode such as a short circuit or an open circuit. If any special mode exceeding the absolute maximum ratings is assumed, consideration should be given to take physical safety measures including the use of fuses, etc.
- (2) Recommended operating conditions
These conditions represent a range within which characteristics can be provided approximately as expected. The electrical characteristics are guaranteed under the conditions of each parameter.
- (3) Reverse connection of power supply connector
The reverse connection of power supply connector can break down ICs. Take protective measures against the breakdown due to the reverse connection, such as mounting an external diode between the power supply and the IC's power supply terminal.
- (4) Power supply line
Design PCB pattern to provide low impedance for the wiring between the power supply and the GND lines.
In this regard, for the digital block power supply and the analog block power supply, even though these power supplies has the same level of potential, separate the power supply pattern for the digital block from that for the analog block, thus suppressing the diffraction of digital noises to the analog block power supply resulting from impedance common to the wiring patterns. For the GND line, give consideration to design the patterns in a similar manner.
Furthermore, for all power supply terminals to ICs, mount a capacitor between the power supply and the GND terminal. At the same time, in order to use an electrolytic capacitor, thoroughly check to be sure the characteristics of the capacitor to be used present no problem including the occurrence of capacity dropout at a low temperature, thus determining the constant.
- (5) GND voltage
Make setting of the potential of the GND terminal so that it will be maintained at the minimum in any operating state.
Furthermore, check to be sure no terminals are at a potential lower than the GND voltage including an actual electric transient.
- (6) Short circuit between terminals and erroneous mounting
In order to mount ICs on a set PCB, pay thorough attention to the direction and offset of the ICs. Erroneous mounting can break down the ICs. Furthermore, if a short circuit occurs due to foreign matters entering between terminals or between the terminal and the power supply or the GND terminal, the ICs can break down.
- (7) Operation in strong electromagnetic field
Be noted that using ICs in the strong electromagnetic field can malfunction them.
- (8) Inspection with set PCB
On the inspection with the set PCB, if a capacitor is connected to a low-impedance IC terminal, the IC can suffer stress. Therefore, be sure to discharge from the set PCB by each process. Furthermore, in order to mount or dismount the set PCB to/from the jig for the inspection process, be sure to turn OFF the power supply and then mount the set PCB to the jig. After the completion of the inspection, be sure to turn OFF the power supply and then dismount it from the jig. In addition, for protection against static electricity, establish a ground for the assembly process and pay thorough attention to the transportation and the storage of the set PCB.
- (9) Input terminals
In terms of the construction of IC, parasitic elements are inevitably formed in relation to potential. The operation of the parasitic element can cause interference with circuit operation, thus resulting in a malfunction and then breakdown of the input terminal. Therefore, pay thorough attention not to handle the input terminals, such as to apply to the input terminals a voltage lower than the GND respectively, so that any parasitic element will operate. Furthermore, do not apply a voltage to the input terminals when no power supply voltage is applied to the IC. In addition, even if the power supply voltage is applied, apply to the input terminals a voltage lower than the power supply voltage or within the guaranteed value of electrical characteristics.
- (10) Ground wiring pattern
If small-signal GND and large-current GND are provided, It will be recommended to separate the large-current GND pattern from the small-signal GND pattern and establish a single ground at the reference point of the set PCB so that resistance to the wiring pattern and voltage fluctuations due to a large current will cause no fluctuations in voltages of the small-signal GND. Pay attention not to cause fluctuations in the GND wiring pattern of external parts as well.
- (11) External capacitor
In order to use a ceramic capacitor as the external capacitor, determine the constant with consideration given to a degradation in the nominal capacitance due to DC bias and changes in the capacitance due to temperature, etc.

●Ordering part number

B	U
---	---

Part No.

2	2	8	5
---	---	---	---

Part No.
2285
2363

F	V
---	---

Package
FV:SSOP-B24
FV:SSOP-B16

-

E	2
---	---

Packaging and forming specification
E2: Embossed tape and reel

SSOP-B24

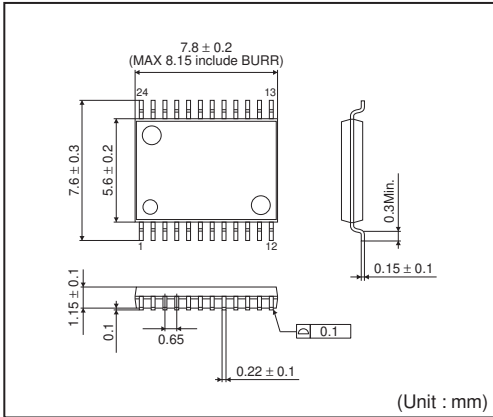

<Tape and Reel information>

Tape	Embossed carrier tape
Quantity	2000pcs
Direction of feed	E2 (The direction is the 1pin of product is at the upper left when you hold reel on the left hand and you pull out the tape on the right hand)

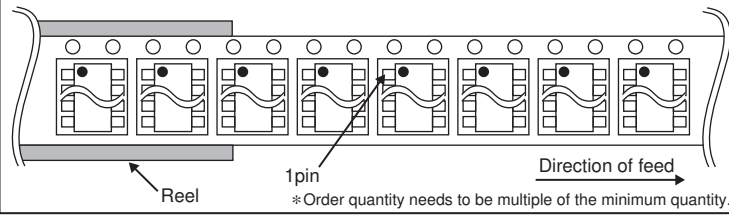

SSOP-B16

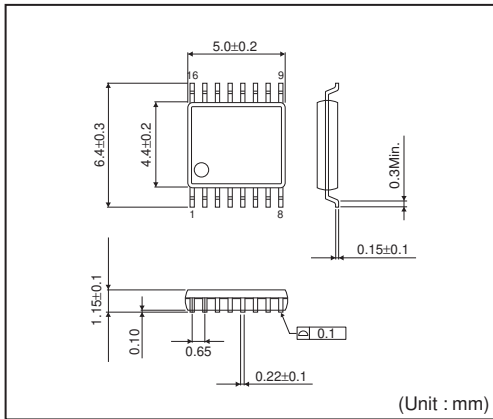

<Tape and Reel information>

Tape	Embossed carrier tape
Quantity	2500pcs
Direction of feed	E2 (The direction is the 1pin of product is at the upper left when you hold reel on the left hand and you pull out the tape on the right hand)

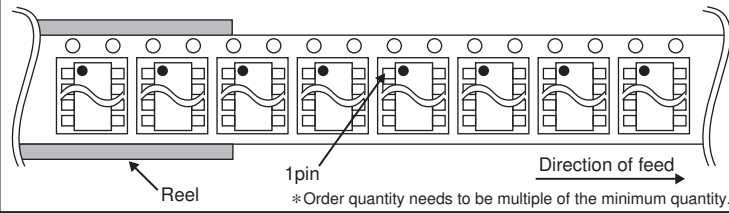

Notes

No copying or reproduction of this document, in part or in whole, is permitted without the consent of ROHM Co.,Ltd.

The content specified herein is subject to change for improvement without notice.

The content specified herein is for the purpose of introducing ROHM's products (hereinafter "Products"). If you wish to use any such Product, please be sure to refer to the specifications, which can be obtained from ROHM upon request.

Examples of application circuits, circuit constants and any other information contained herein illustrate the standard usage and operations of the Products. The peripheral conditions must be taken into account when designing circuits for mass production.

Great care was taken in ensuring the accuracy of the information specified in this document. However, should you incur any damage arising from any inaccuracy or misprint of such information, ROHM shall bear no responsibility for such damage.

The technical information specified herein is intended only to show the typical functions of and examples of application circuits for the Products. ROHM does not grant you, explicitly or implicitly, any license to use or exercise intellectual property or other rights held by ROHM and other parties. ROHM shall bear no responsibility whatsoever for any dispute arising from the use of such technical information.

The Products specified in this document are intended to be used with general-use electronic equipment or devices (such as audio visual equipment, office-automation equipment, communication devices, electronic appliances and amusement devices).

The Products specified in this document are not designed to be radiation tolerant.

While ROHM always makes efforts to enhance the quality and reliability of its Products, a Product may fail or malfunction for a variety of reasons.

Please be sure to implement in your equipment using the Products safety measures to guard against the possibility of physical injury, fire or any other damage caused in the event of the failure of any Product, such as derating, redundancy, fire control and fail-safe designs. ROHM shall bear no responsibility whatsoever for your use of any Product outside of the prescribed scope or not in accordance with the instruction manual.

The Products are not designed or manufactured to be used with any equipment, device or system which requires an extremely high level of reliability the failure or malfunction of which may result in a direct threat to human life or create a risk of human injury (such as a medical instrument, transportation equipment, aerospace machinery, nuclear-reactor controller, fuel-controller or other safety device). ROHM shall bear no responsibility in any way for use of any of the Products for the above special purposes. If a Product is intended to be used for any such special purpose, please contact a ROHM sales representative before purchasing.

If you intend to export or ship overseas any Product or technology specified herein that may be controlled under the Foreign Exchange and the Foreign Trade Law, you will be required to obtain a license or permit under the Law.



Thank you for your accessing to ROHM product informations.
More detail product informations and catalogs are available, please contact us.

ROHM Customer Support System

<http://www.rohm.com/contact/>

