



Chipsmall Limited consists of a professional team with an average of over 10 year of expertise in the distribution of electronic components. Based in Hongkong, we have already established firm and mutual-benefit business relationships with customers from,Europe,America and south Asia,supplying obsolete and hard-to-find components to meet their specific needs.

With the principle of "Quality Parts,Customers Priority,Honest Operation,and Considerate Service",our business mainly focus on the distribution of electronic components. Line cards we deal with include Microchip,ALPS,ROHM,Xilinx,Pulse,ON,Everlight and Freescale. Main products comprise IC,Modules,Potentiometer,IC Socket,Relay,Connector.Our parts cover such applications as commercial,industrial, and automotives areas.

We are looking forward to setting up business relationship with you and hope to provide you with the best service and solution. Let us make a better world for our industry!



Contact us

Tel: +86-755-8981 8866 Fax: +86-755-8427 6832

Email & Skype: info@chipsmall.com Web: www.chipsmall.com

Address: A1208, Overseas Decoration Building, #122 Zhenhua RD., Futian, Shenzhen, China



DC Brushless Fan Motor Driver 5V Single-phase Full-wave Fan Motor Driver



BU6906NUX

●General Description

The BU6906NUX is a 5V single-phase full-wave FAN motor driver with built in HALL element. This is a DC brushless FAN motor driver series.

That has compact package, auto gain control function (Henceforth, abbreviated to AGC), silent drive by soft switching, and low battery consumption by standby function.

This is the best lineup for note PC cooling FANs.

●Features

- Built in HALL element.
- Auto Gain Control function (AGC).
- Soft switching drive (PWM type)
- Low PWM duty start up
- Quick start function
- Stand-by mode
- Incorporating lock protection and automatic restart circuit.
- Compact package
- Rotating speed pulse signal (FG) output
- PWM speed control

●Package(s)

VSON008X2030

W(Typ.) x D(Typ.) x H(Max.)
2.00mm x 3.00mm x 0.60mm

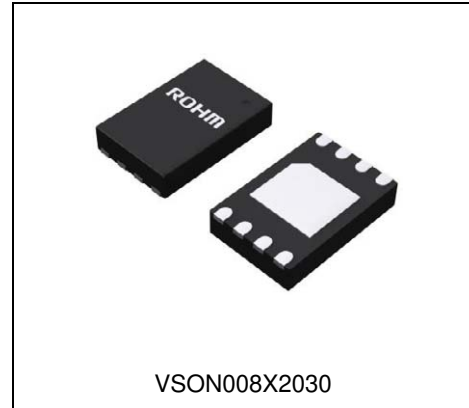

●Applications

- For compact 5V FAN such as notebook PC cooling FAN

●Absolute Maximum Ratings

Parameter	Symbol	Limit	Unit
Supply voltage	Vcc	7	V
Power dissipation	Pd	410*	mW
Operating temperature	Topr	-40 to +85	°C
Storage temperature	Tstg	-55 to +125	°C
Output voltage	Vomax	7	V
Output current	Iomax	800**	mA
FG signal output voltage	Vfg	7	V
FG signal output current	Ifg	10	mA
Junction temperature	Tjmax	125	°C

* Reduce by 4.1mW/°C over 25°C. (70.0mm×70.0mm×1.6mm glass epoxy board)

** This value is not to exceed Pd.

●Operating Rating

Parameter	Symbol	Limit	Unit
Operating supply voltage range	Vcc	1.8 to 5.5	V

●Block Diagram

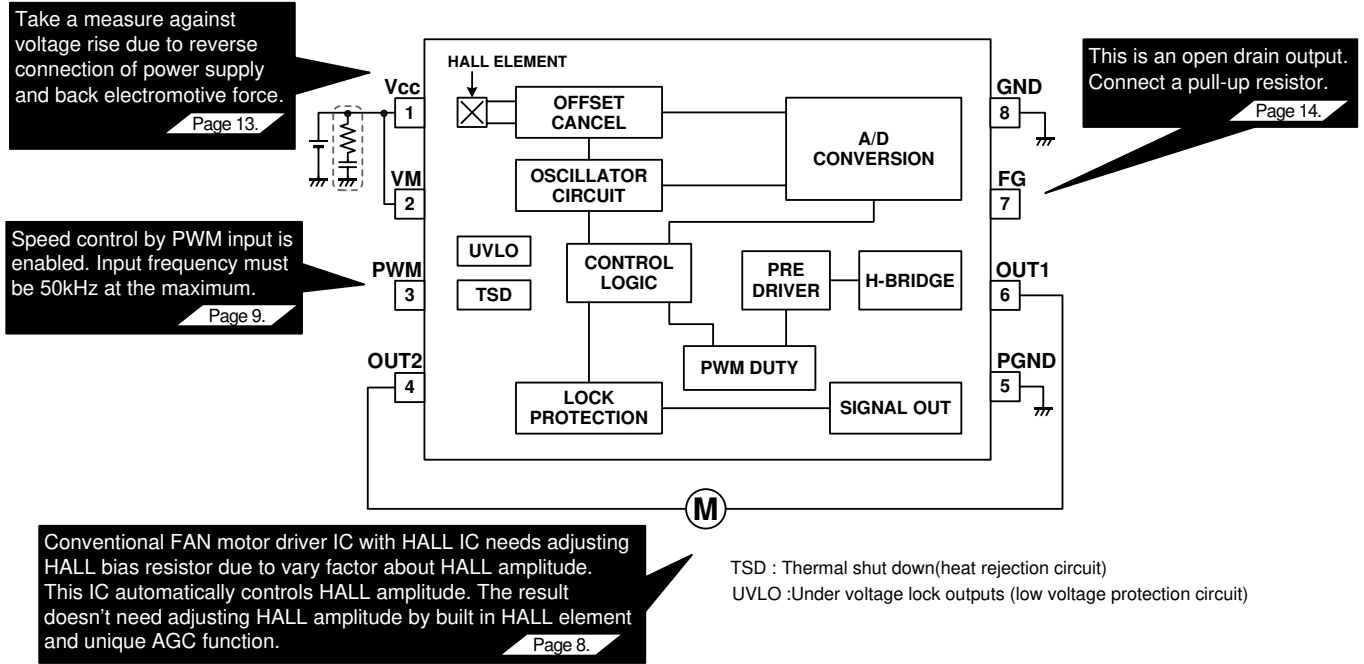

Figure 1. Block diagram and application circuit

●Pin Description

P/No.	T/Name	Function
1	Vcc	Power supply terminal 1
2	VM	Power supply terminal 2
3	PWM	PWM signal input terminal
4	OUT2	Motor output terminal 2
5	PGND	Ground terminal 2
6	OUT1	Motor output terminal 1
7	FG	FG signal output terminal
8	GND	Ground terminal 1

●I/O truth table

• Supply magnetic direction (positive)

• Output operation

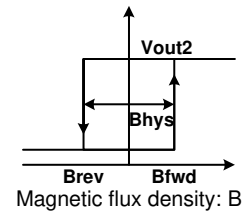
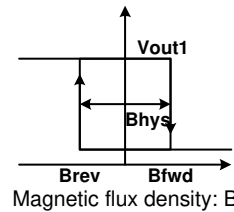
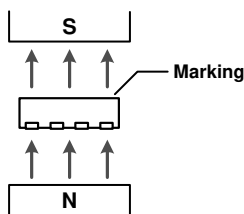

Figure 2. Output operation

Supply magnetic direction	PWM*	OUT1	OUT2	FG
S	H(OPEN)	L	H	H (Tr : OFF)
N	H(OPEN)	H	L	L (Tr : ON)
S	L	L	L	H (Tr : OFF)
N	L	L	L	H (Tr : OFF)

*When PWM terminal is input L, IC state changes stand-by mode. FG terminal is H constant in stand-by mode

● **Electrical Characteristic(s)** (Unless otherwise specified Ta=25°C, Vcc=5V)

Parameter	Symbol	Limit			Unit	Conditions	Characteristics
		MIN	TYP	MAX			
Circuit current 1	Icc1	-	2	4	mA	PWM=OPEN	Figure 3.
Circuit current 2 (stand-by mode)	Icc2	-	50	-	uA	PWM=GND	Figure 4.
Magnetic switch-point for forward rotation	Bfwd	-	1.5	-	mT		Figure 5.
Magnetic switch-point for reverse rotation	Brev	-	-1.5	-	mT		Figure 6.
Magnetic hysteresis	Bhys	-	3.0	5.0	mT		Figure 7.
PWM input H level	Pwmh	2.5	-	Vcc	V		-
PWM input L level	Pwml	0	-	0.7	V		-
PWM Input frequency	Pwmf	5	-	50	kHz		-
Output voltage	Vo	-	0.16	0.24	V	Io=200mA Upper and Lower total	Figure 8 to 13.
FG low voltage	Vfgl	-	-	0.4	V	I _{fg} =5mA	Figure 14,15.
FG leak current	I _{fgl}	-	-	5	μA	V _{fg} =7V	Figure 16.
Lock detection ON time	Ton	0.35	0.50	0.65	s		Figure 17.
Lock detection OFF time	Toff	3.5	5.0	6.5	s		Figure 18.

● Typical Performance Curves 1

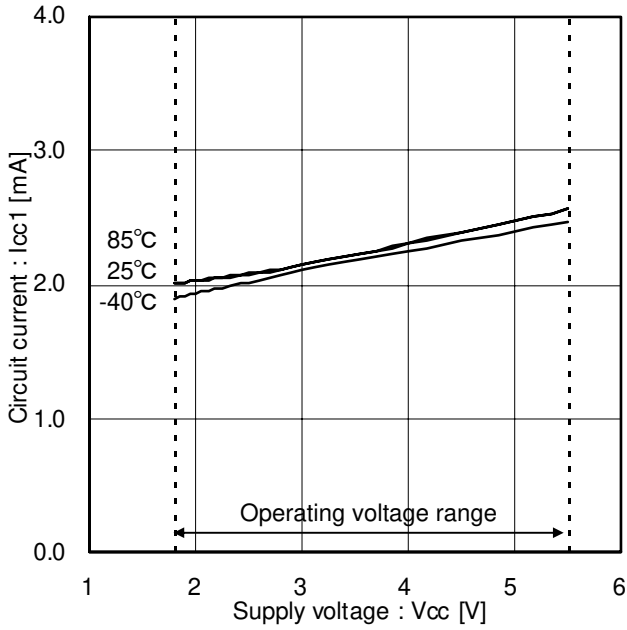

Figure 3. Circuit current 1

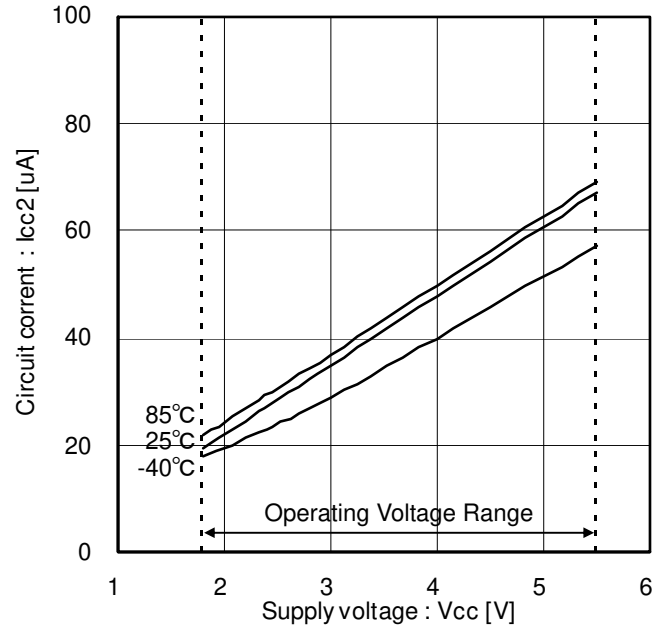

Figure 4. Circuit current 2 (Stand-by mode)

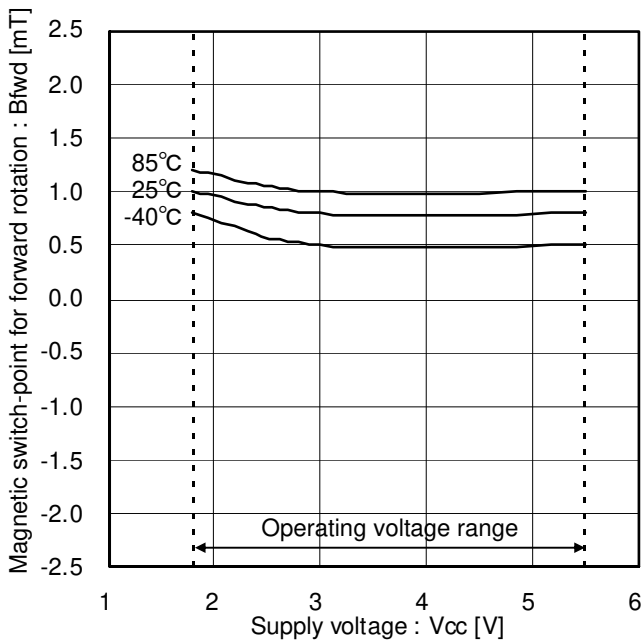

Figure 5. Magnetic switch-point for forward rotation

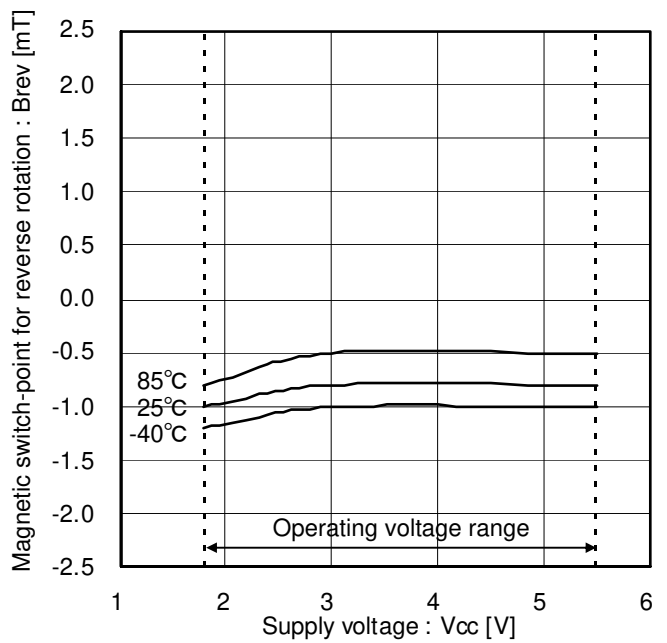

Figure 6. Magnetic switch-point for reverse rotation

● Typical Performance Curves 2

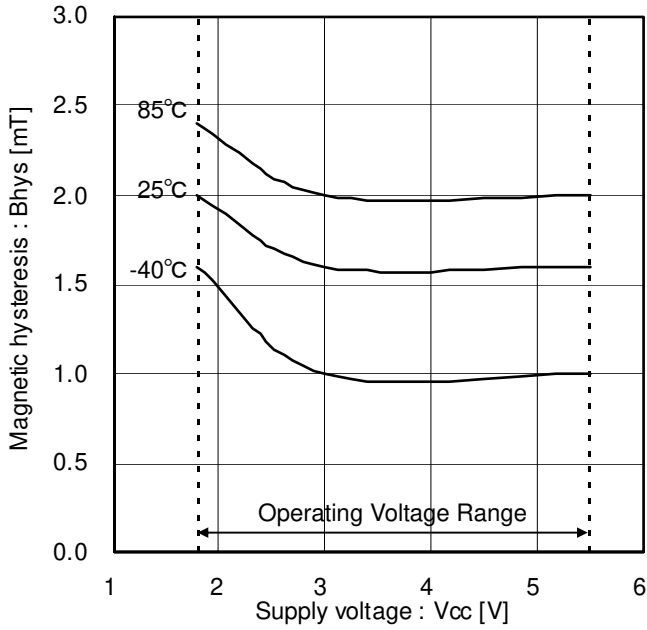

Figure 7. Magnetic hysteresis

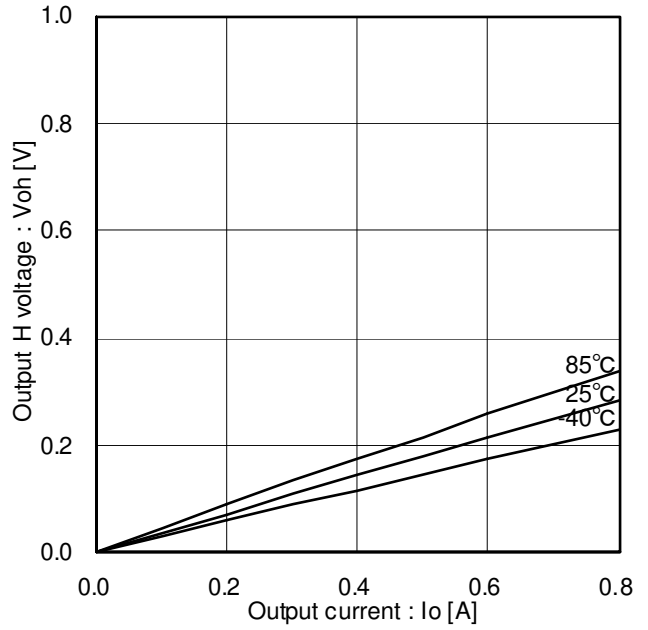

Figure 8. Output H voltage (Temperature characteristics)

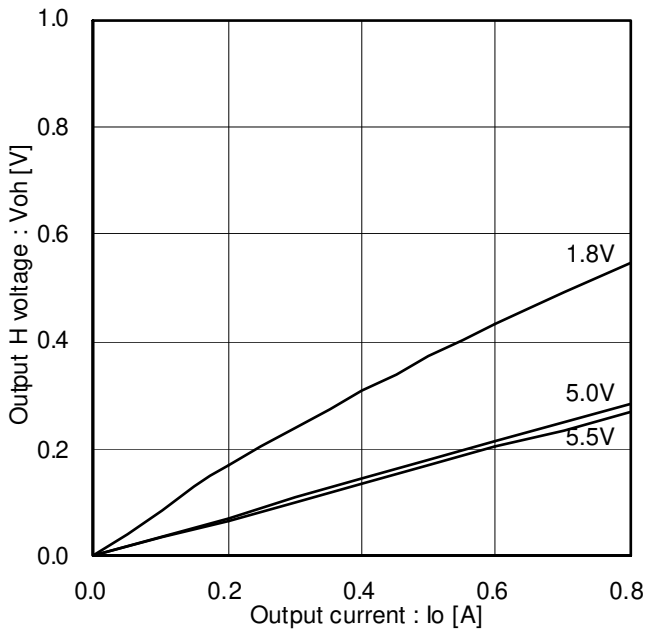

Figure 9. Output H voltage (Voltage characteristics)

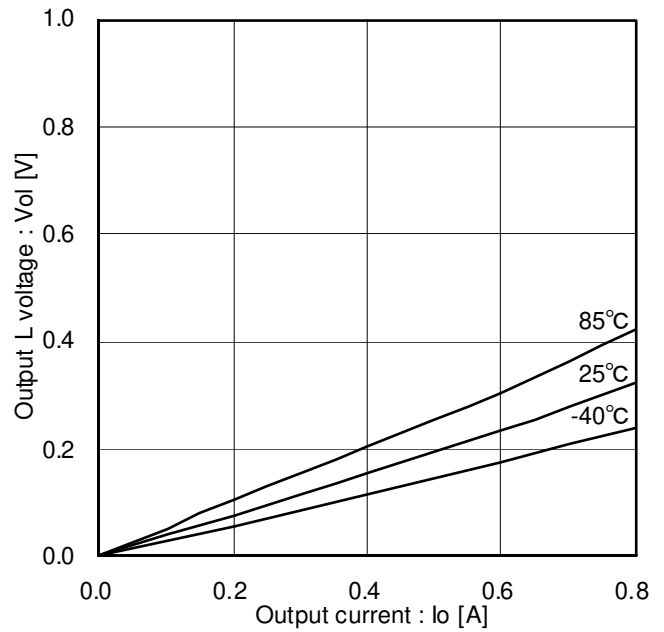

Figure 10. Output L voltage (Temperature characteristics)

● Typical Performance Curves 3

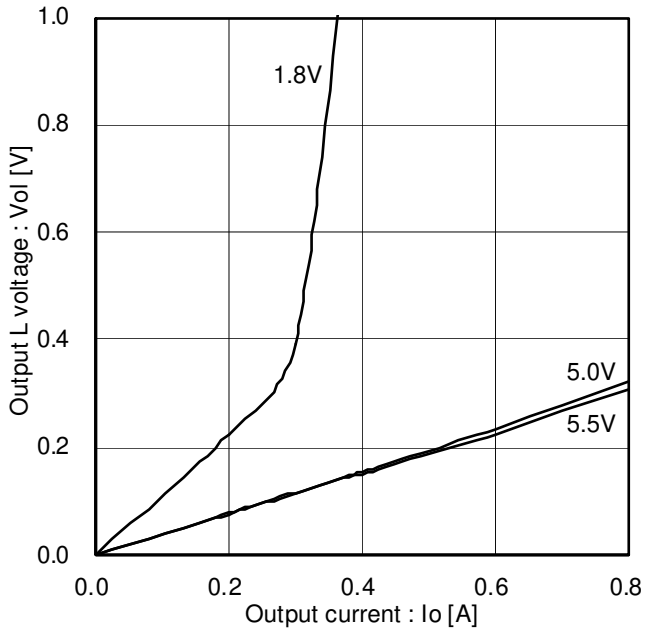

Figure 11. Output L voltage (Voltage characteristics)

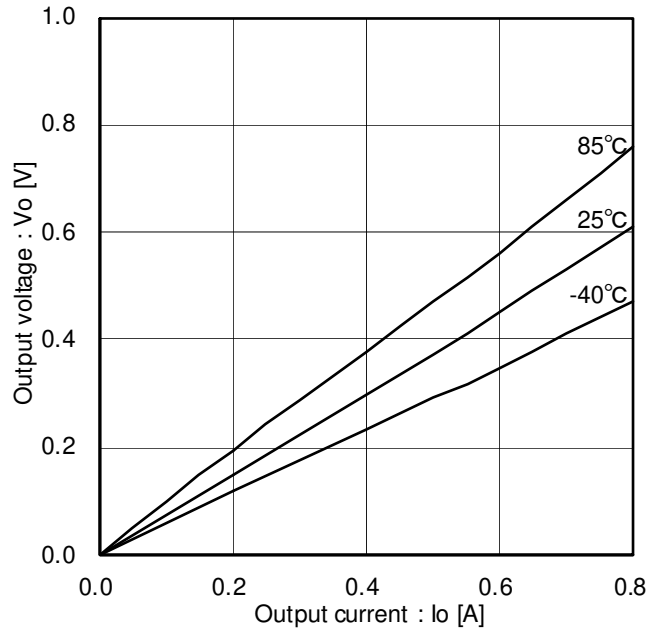

Figure 12. Output voltage (Upper and lower total) (Temperature characteristics)

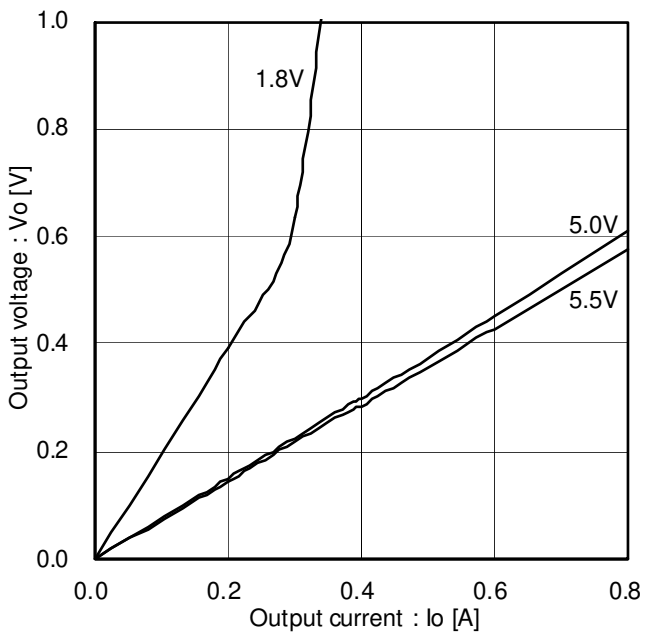

Figure 13. Output voltage (Upper and lower total) (Voltage characteristics)

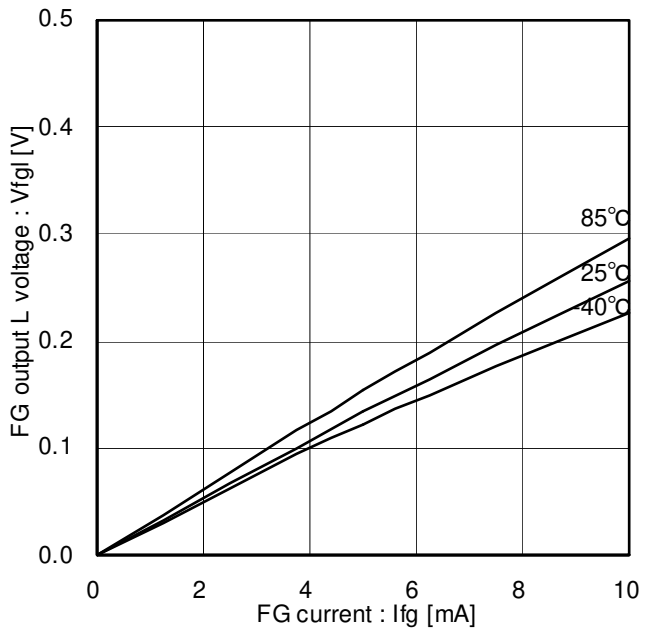

Figure 14. FG output L voltage (Temperature characteristics)

● Typical Performance Curves 4

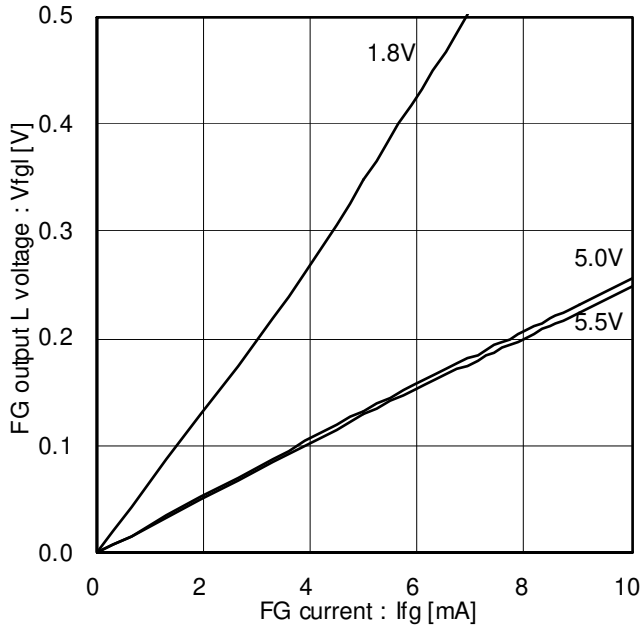

Figure 15. FG output L voltage (Voltage characteristics)

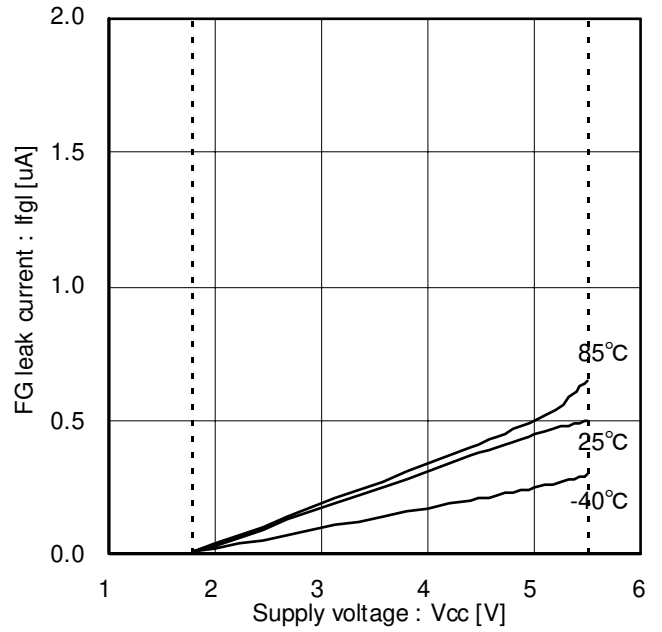

Figure 16. FG Output leak current

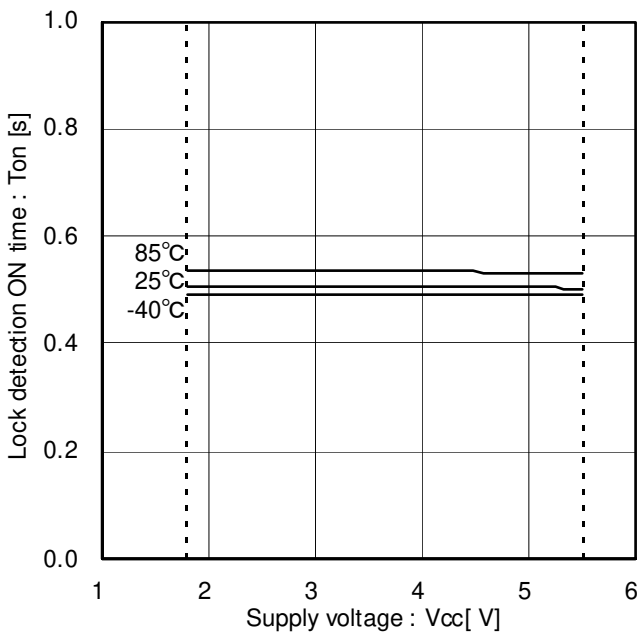

Figure 17. Lock detection ON time

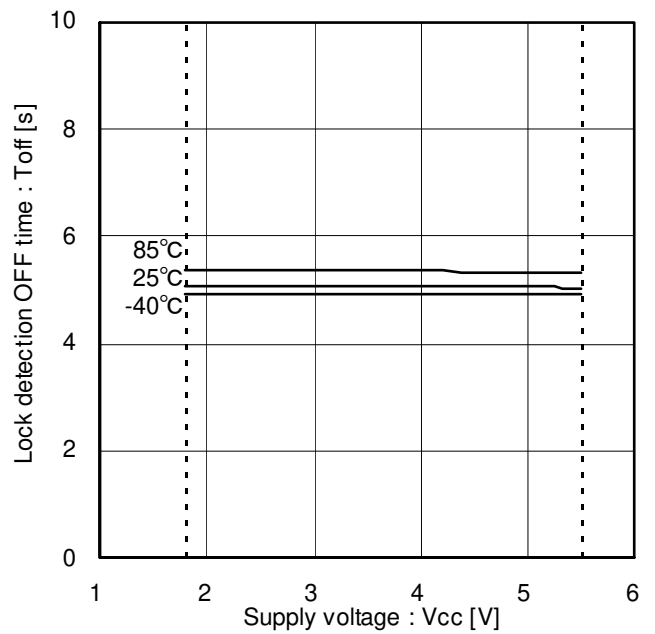

Figure 18. Lock detection OFF time

●Auto gain control

Conventional FAN motor driver IC with HALL IC needs adjusting HALL bias resistor due to vary factor about HALL amplitude. This IC automatically controls HALL amplitude generated by built in HALL element and motor magnet. The result doesn't need adjusting HALL amplitude by built in HALL element and unique AGC function. AGC function needs selecting 30ms time for HALL amp gain when turning on the power, recovering from stand-by mode and lock protection.(Refer to Figure 22 and 23.)

●Soft switching (PWM type)

Soft switching is operated using output PWM switching. The output PWM signal is generated by the slope of AGC HALL signal. The first, the AGC HALL signal is converted to absolute waveform. Next, synthesize the absolute waveform and the triangular waveform by inside IC generated. The synthesized waveform has determined PWM soft switching duty and the ratio of time.

PWM soft switching time depends on motor speed. In case of HALL signal a slower, PWM soft switching time is long due to the obtuse angle of the AGC HALL signal. (PWM soft switching time is about 2ms to 4ms.) The other, in case of HALL signal a faster, PWM soft switching time is short due to the sharp slope of the AGC HALL signal. (PWM soft switching time is about 200μs to 1ms.) And, PWM soft switching frequency is 50 kHz (typical) for making triangle oscillator IC inside. Hence, input PWM frequency is not equal to PWM soft switching frequency.

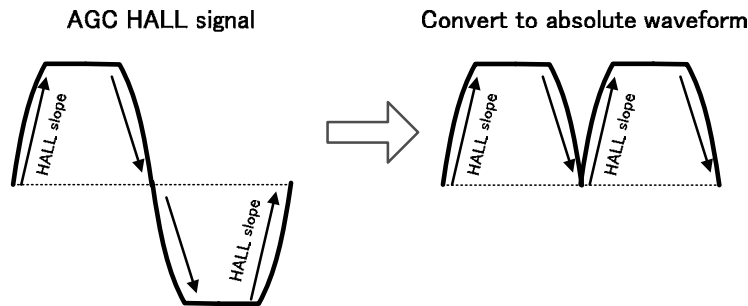

(a) Convert to absolute waveform from the AGC HALL signal

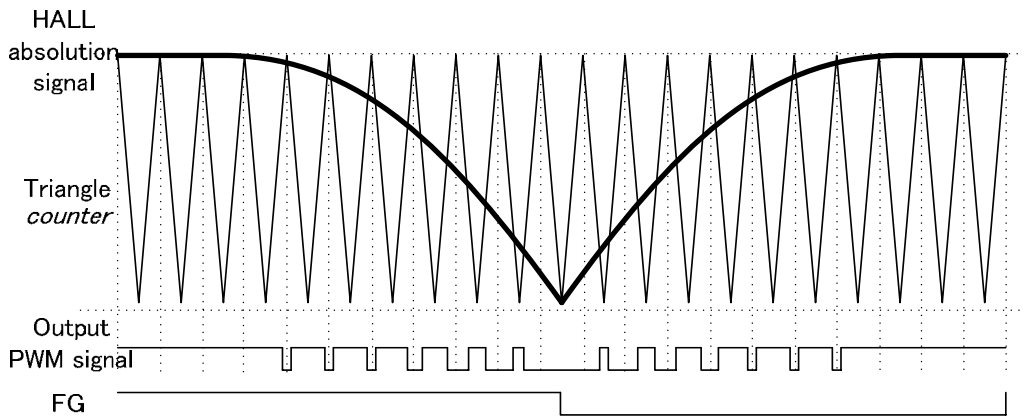

(b) Motor speed is slow

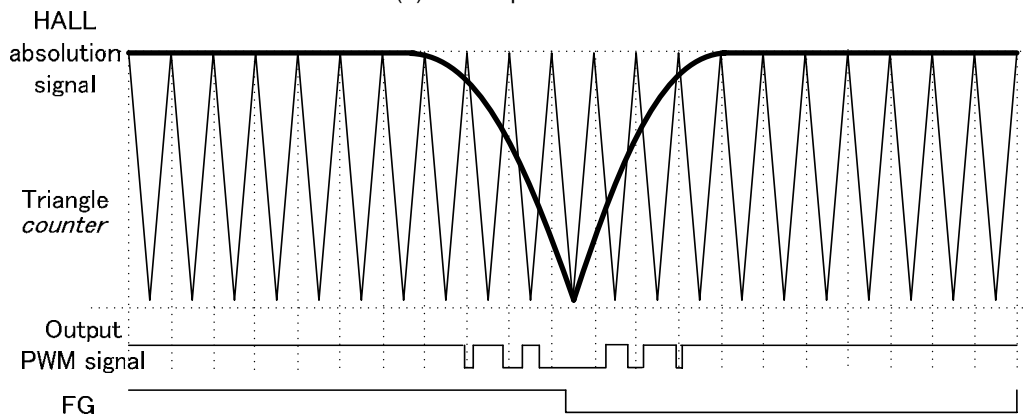

(c) Motor speed is fast

Figure 19. PWM soft switching signal synthesis

●PWM control

Rotation speed of motor can be changed by controlling ON/OFF of the upper output depending on duty of the signal input to PWM terminal. When PWM terminal is open, H logic is applied. Output PWM frequency is 50 kHz (typical). This IC is not direct PWM. Hence, input PWM frequency is not equal to output PWM frequency. Figure 20. shows characteristic input PWM duty and output PWM duty.

PWM terminal build in digital low pass filter (Henceforth abbreviated to LPF). Output PWM duty transitional time is max 3.5 ms from changing input PWM duty by LPF characteristic (Reference is shown in Figure 21.) . Additionally, Input PWM frequency uses more than 5 kHz.

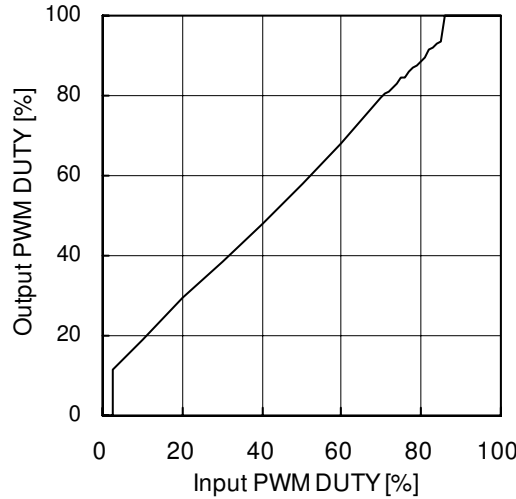

Figure 20. Characteristic input PWM DUTY and output PWM DUTY

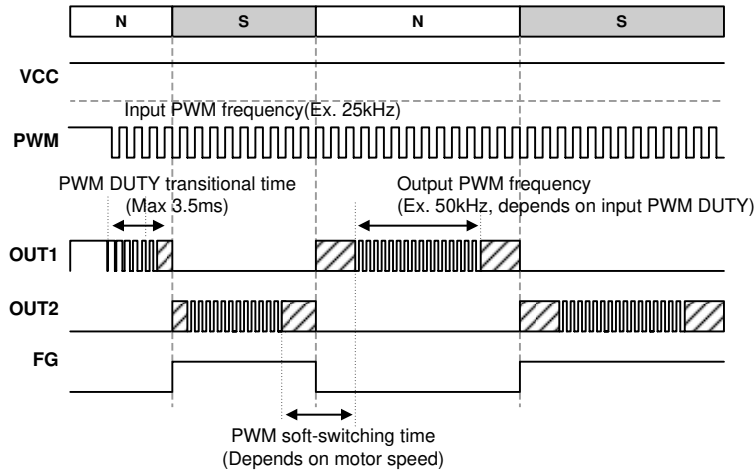

Figure 21. Timing chart in PWM control

● Low duty start up function

When motor starts up from stop condition, outputs are driven in about PWM 50% duty until 3 times changing magnetic direction. The output duty depends on the input PWM duty (except 0%). Even if input duty of PWM signal is low, the motor can be started. In case of input PWM duty area 2.5% to 50%, output PWM starts all 50% until 3 times changing magnetic direction. After the low PWM duty start up function, output PWM duty changes corresponding to input PWM duty. The other, in case of input PWM duty range more than 50%, output PWM duty changes corresponding to same input PWM duty at all driving time. Even if input duty of PWM signal is more less 50%, the motor can be started by this function.

When input PWM duty is 0%, the motor can be stay stand-by mode. Additionally, the motor changes idling mode in input PWM duty range from 0% to 2.5%. Idling mode only runs circuit current (Icc1) of IC. Idling mode is made all outputs terminals to open state.

Ex. PWM : 25kHz, DUTY20%

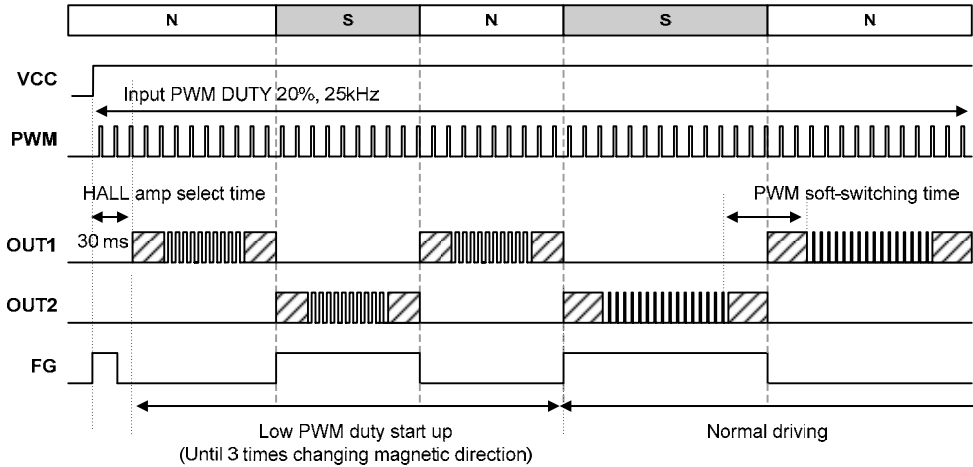

(a) Case A : Input PWM DUTY 2.5% to 50%

Ex. PWM : 25kHz, DUTY80%

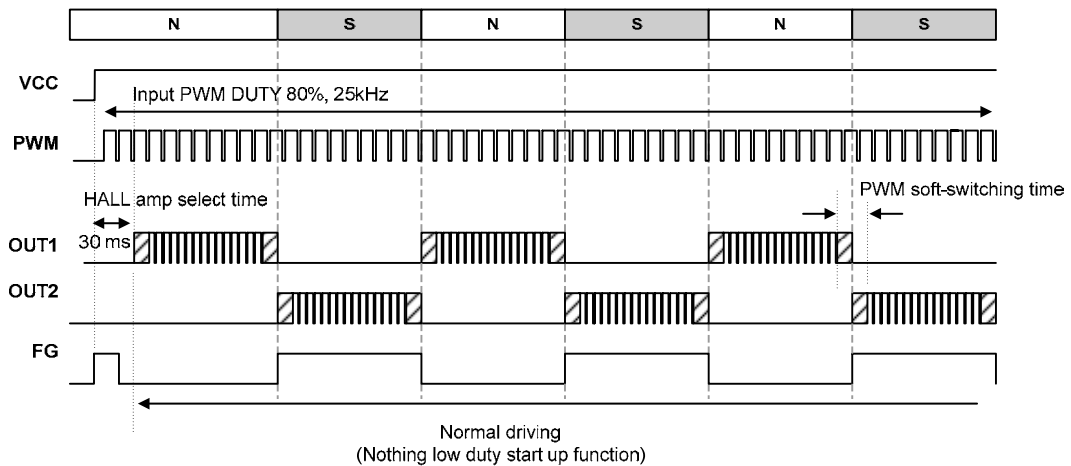

(b) Case B : Input PWM DUTY 50% to 100%

Figure 22. Low duty start up function

Table 1 Truth table input PWM duty and each outputs terminals

Input PWM duty [%]	IC function (state)	OUT1, OUT2	FG
DUTY 0	OFF (Stand-by mode)	OFF, OFF (Open state)	H (Output Tr : OFF)
DUTY 0 < 2.5	ON (Idle mode)	OFF, OFF (Open state)	H (Output Tr : OFF)
Case A : DUTY 2.5 to 50	ON (Low duty start up driving)	H / L, L / H	H / L
Case B : DUTY 50 to 100	ON (Normal driving)	H / L, L / H	H / L

●Quick start function

The quick start function is built into this series. When the PWM signal is input, this function can start up the motor at once regardless of the detection time of the lock protection function. (Notice, need HALL amp gain select time. Reference is shown in Figure 23.)

●Stand-by mode

Stand-by function turns off the circuit when the time of PWM=L has elapsed in order to reduce stand-by current. The circuit current in stand-by mode is specified at the parameter "Circuit current 2" of electrical characteristics. Figure 23. shows timing chart stand-by mode and quick start function.

The 0% detection time for changing stand-by mode is variable by input PWM duty. Because this IC has a LPF after PWM terminal. For example input PWM frequency 25kHz, the characteristic 0% detection time and input PWM duty is shown in Figure 24.

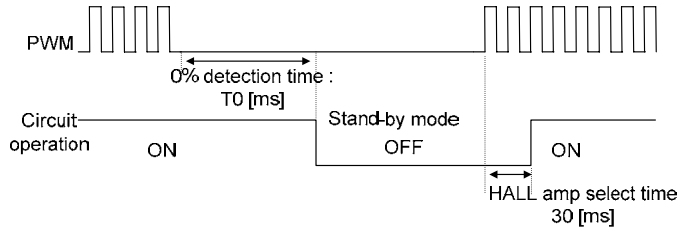

Figure 23. Stand-by mode and quick start function

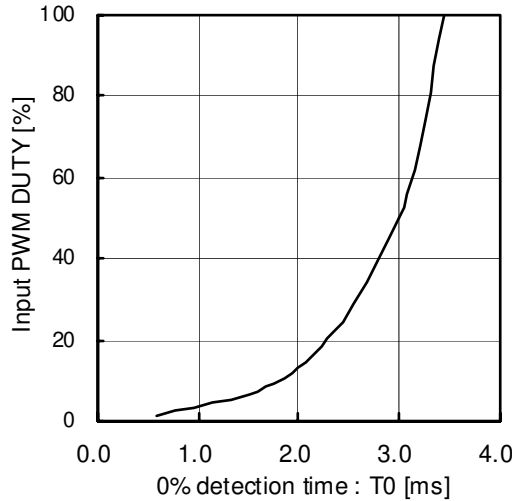

Figure 24. Characteristic 0% detection time and input PWM duty at 25kHz

●Lock protection and automatic restart

Motor rotation is detected by HALL signal, and lock detection ON time (Ton) and lock detection OFF time (Toff) are set by IC internal counter. External part (C or R) is not required. Timing chart is shown in Figure 25.

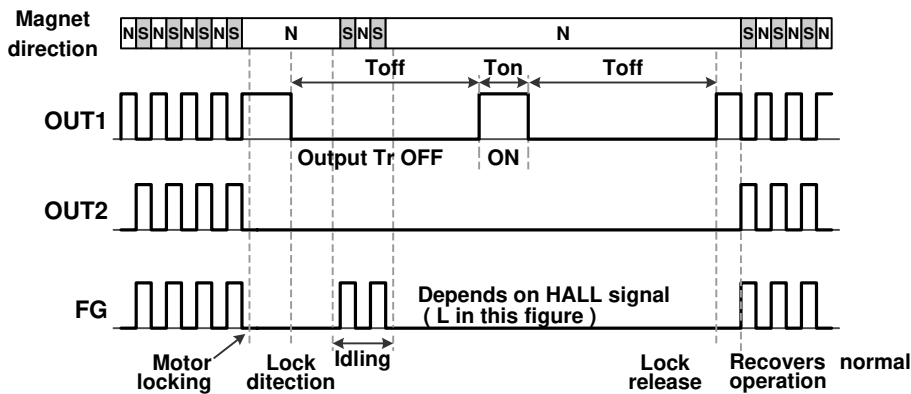
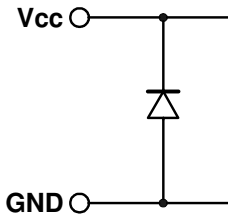

Figure 25. Lock protection timing chart

●Equivalent circuit

1) Supply voltage terminal



2) PWM signal input terminal

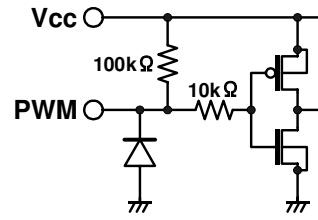

3) FG output terminal

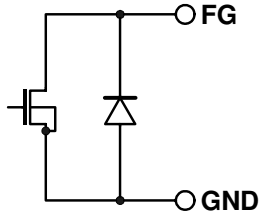

4) Motor output terminal

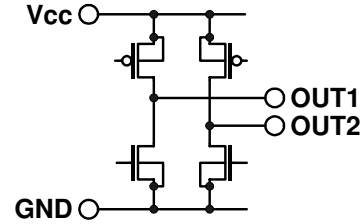

●HALL position (Reference data)

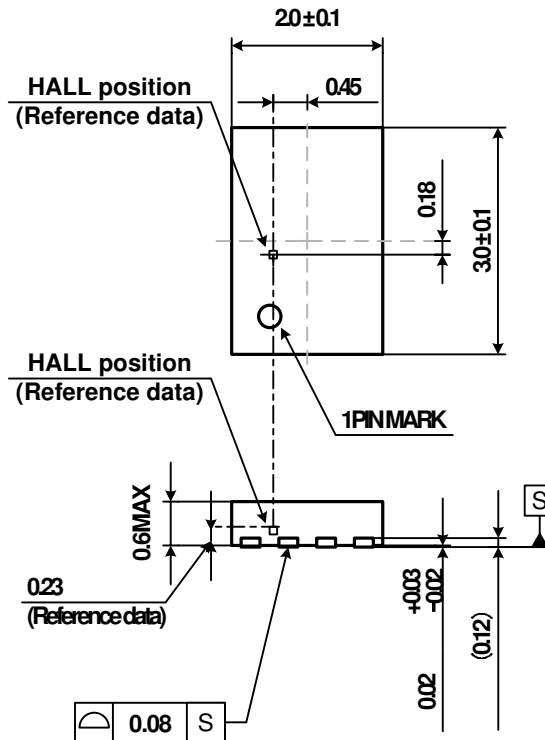

● Safety measure

1) Reverse connection protection diode

Reverse connection of power results in IC destruction as shown in Figure 26. When reverse connection is possible, reverse connection protection diode must be added between power supply and Vcc.

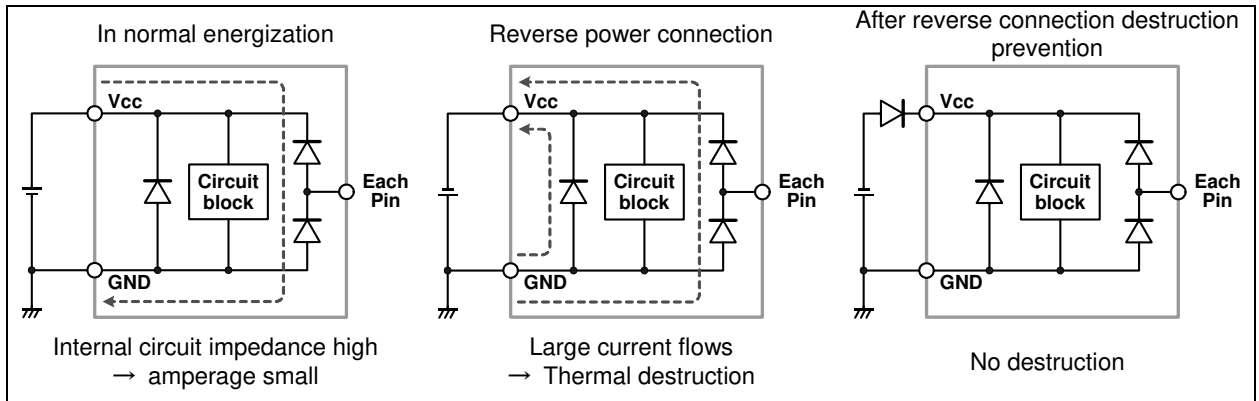

Figure 26. Flow of current when power is connected reversely

2) Measure against Vcc voltage rise by back electromotive force

Back electromotive force (Back EMF) generates regenerative current to power supply. However, when reverse connection protection diode is connected, Vcc voltage rises because the diode prevents current flow to power supply.

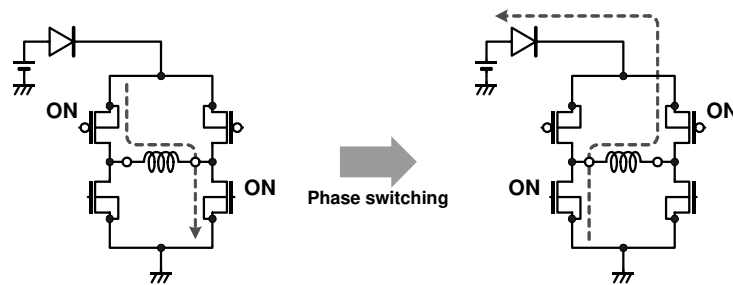

Figure 27. Vcc voltage rise by back electromotive force

When the absolute maximum rated voltage may be exceeded due to voltage rise by back electromotive force, place (A) Capacitor or (B) Zener diode between Vcc and GND. If necessary, add both (C). (D) Capacitor and resistor are improved ESD surge destruction.

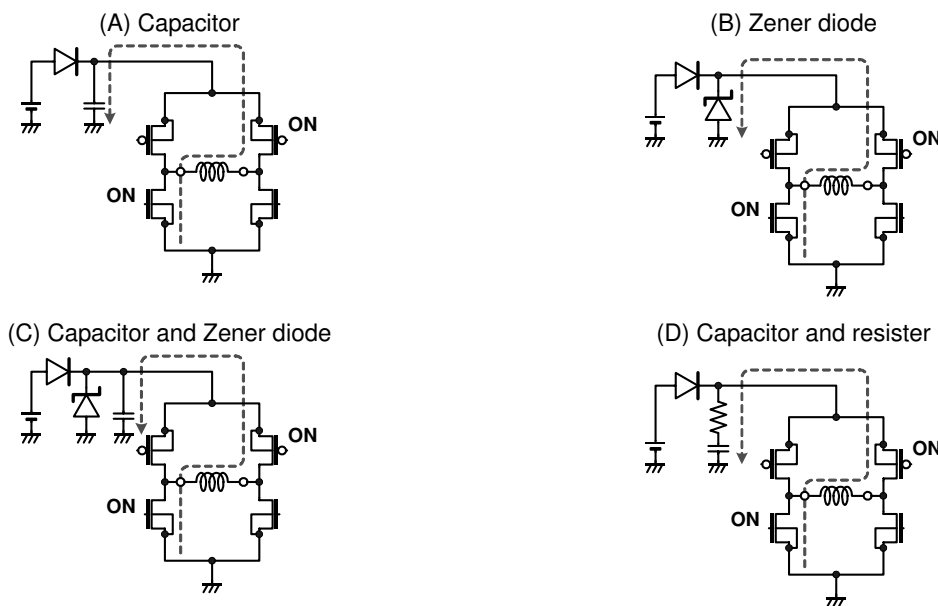

Figure 28. Measure against Vcc voltage rise

3) Problem of GND line PWM switching

Do not perform PWM switching of GND line because GND terminal potential cannot be kept to a minimum.

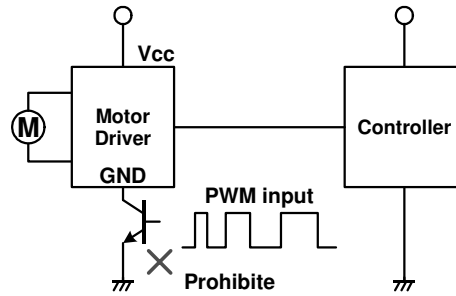

Figure 29. GND Line PWM switching prohibited

4) FG output

FG output is an open collector and requires pull-up resistor. The IC can be protected by adding resistor R1. An excess of absolute maximum rating, when FG output terminal is directly connected to power supply, could damage the IC.

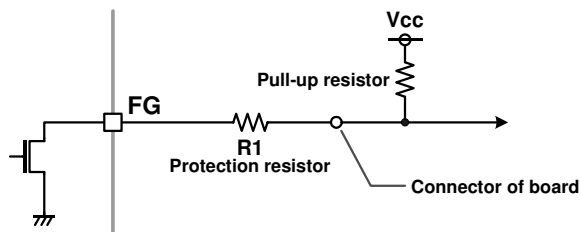
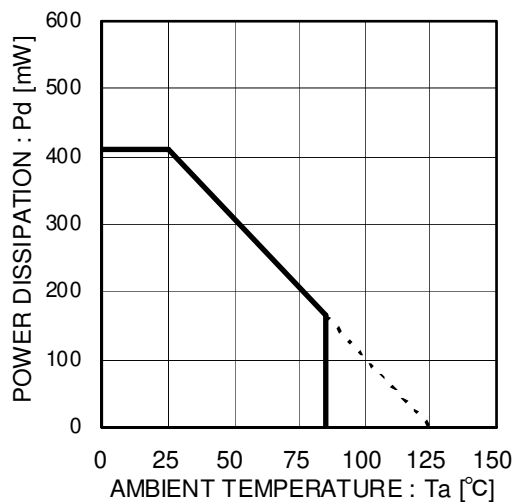

Figure 30. Protection of FG terminal

● Thermal derating curve

Thermal derating curve indicates power that can be consumed by IC with reference to ambient temperature. Power that can be consumed by IC begins to attenuate at certain ambient temperature. This gradient is determined by thermal resistance θ_{ja} .

Thermal resistance θ_{ja} depends on chip size, power consumption, package ambient temperature, packaging condition, wind velocity, etc., even when the same package is used. Thermal derating curve indicates a reference value measured at a specified condition. Figure 31. shows a thermal derating curve.



Reduce by 4.1mW/°C over 25°C.
(70.0mm × 70.0mm × 1.6mm FR4 glass epoxy board)

Figure 31. Thermal derating curve

●Operational Notes

- 1) Absolute maximum ratings
Devices may be destroyed when supply voltage or operating temperature exceeds the absolute maximum ratings. Because the cause of this damage cannot be identified as a short circuit or an open circuit, if any over rated values will expect to exceed the absolute maximum ratings, consider adding circuit protection devices, such as fuses.
- 2) Connecting the power supply connector backward
Connecting of the power supply in reverse polarity can damage IC. Take precautions when connecting the power supply lines. An external direction diode can be added.
- 3) Power supply line
Back electromotive force causes regenerated current to power supply line, therefore take a measure such as placing a capacitor between power supply and GND for routing regenerated current. And fully ensure that the capacitor characteristics have no problem before determine a capacitor value. (when applying electrolytic capacitors, capacitance characteristic values are reduced at low temperatures)
- 4) GND potential
It is possible that the motor output terminal may deflect below GND terminal because of influence by back electromotive force of motor. The potential of GND terminal must be minimum potential in all operating conditions, except that the levels of the motor outputs terminals are under GND level by the back electromotive force of the motor coil. Also ensure that all terminals except GND and motor output terminals do not fall below GND voltage including transient characteristics. Malfunction may possibly occur depending on use condition, environment, and property of individual motor. Please make fully confirmation that no problem is found on operation of IC.
- 5) Thermal design
Use a thermal design that allows for a sufficient margin in light of the power dissipation(Pd) in actual operating conditions.
- 6) Inter-pin shorts and mounting errors
Use caution when positioning the IC for mounting on printed circuit boards. The IC may be damaged if there is any connection error or if pins are shorted together.
- 7) Actions in strong electromagnetic field
Use caution when using the IC in the presence of a strong electromagnetic field as doing so may cause the IC to malfunction.
- 8) ASO
When using the IC, set the output transistor so that it does not exceed absolute maximum ratings or ASO.
- 9) Thermal shut down circuit
The IC incorporates a built-in thermal shutdown circuit (TSD circuit). Operation temperature is 150°C(typ.) and has a hysteresis width of 25°C(typ.). When IC chip temperature rises and TSD circuit works, the output terminal becomes an open state. TSD circuit is designed only to shut the IC off to prevent thermal runaway. It is not designed to protect the IC or guarantee its operation. Do not continue to use the IC after operation this circuit or use the IC in an environment where the operation of this circuit is assumed.
- 10) Testing on application boards
When testing the IC on an application board, connecting a capacitor to a pin with low impedance subjects the IC to stress. Always discharge capacitors after each process or step. Always turn the IC's power supply off before connecting it to or removing it from a jig or fixture during the inspection process. Ground the IC during assembly steps as an antistatic measure. Use similar precaution when transporting or storing the IC.
- 11) GND wiring pattern
When using both small signal and large current GND patterns, it is recommended to isolate the two ground patterns, placing a single ground point at the ground potential of application so that the pattern wiring resistance and voltage variations caused by large currents do not cause variations in the small signal ground voltage. Be careful not to change the GND wiring pattern of any external components, either.
- 12) Capacitor between output and GND
When a large capacitor is connected between output and GND, if Vcc is shorted with 0V or GND for some cause, it is possible that the current charged in the capacitor may flow into the output resulting in destruction. Keep the capacitor between output and GND below 100uF.
- 13) IC terminal input
When Vcc voltage is not applied to IC, do not apply voltage to each input terminal. When voltage above Vcc or below GND is applied to the input terminal, parasitic element is actuated due to the structure of IC. Operation of parasitic element causes mutual interference between circuits, resulting in malfunction as well as destruction in the last. Do not use in a manner where parasitic element is actuated.
- 14) In use
We are sure that the example of application circuit is preferable, but please check the character further more in application to a part which requires high precision. In using the unit with external circuit constant changed, consider the variation of externally equipped parts and our IC including not only static character but also transient character and allow sufficient margin in determining.

Status of this document

The Japanese version of this document is formal specification. A customer may use this translation version only for a reference to help reading the formal version.

If there are any differences in translation version of this document formal version takes priority.

●Physical Dimension Tape and Reel Information

VSON008X2030

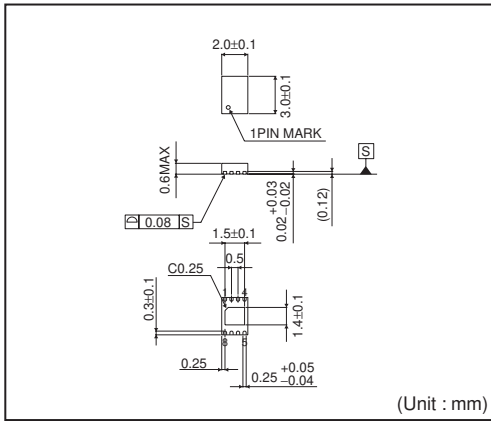

<Tape and Reel information>

Tape	Embossed carrier tape
Quantity	4000pcs
Direction of feed	TR (The direction is the 1 pin of product is at the upper right when you hold reel on the left hand and you pull out the tape on the right hand)

Reel

1 pin

Direction of feed

*Order quantity needs to be multiple of the minimum quantity.

●Marking Diagram(s)(TOP VIEW)

VSON008X2030(TOP VIEW)

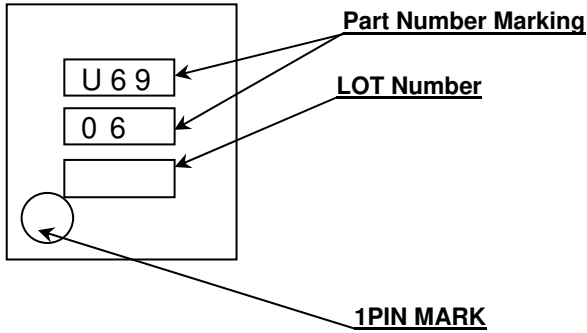

Notice

Precaution on using ROHM Products

- Our Products are designed and manufactured for application in ordinary electronic equipments (such as AV equipment, OA equipment, telecommunication equipment, home electronic appliances, amusement equipment, etc.). If you intend to use our Products in devices requiring extremely high reliability (such as medical equipment ^(Note 1), transport equipment, traffic equipment, aircraft/spacecraft, nuclear power controllers, fuel controllers, car equipment including car accessories, safety devices, etc.) and whose malfunction or failure may cause loss of human life, bodily injury or serious damage to property ("Specific Applications"), please consult with the ROHM sales representative in advance. Unless otherwise agreed in writing by ROHM in advance, ROHM shall not be in any way responsible or liable for any damages, expenses or losses incurred by you or third parties arising from the use of any ROHM's Products for Specific Applications.

(Note1) Medical Equipment Classification of the Specific Applications

JAPAN	USA	EU	CHINA
CLASS III	CLASS III	CLASS II b	CLASS III
CLASS IV		CLASS III	

- ROHM designs and manufactures its Products subject to strict quality control system. However, semiconductor products can fail or malfunction at a certain rate. Please be sure to implement, at your own responsibilities, adequate safety measures including but not limited to fail-safe design against the physical injury, damage to any property, which a failure or malfunction of our Products may cause. The following are examples of safety measures:
 - Installation of protection circuits or other protective devices to improve system safety
 - Installation of redundant circuits to reduce the impact of single or multiple circuit failure
- Our Products are designed and manufactured for use under standard conditions and not under any special or extraordinary environments or conditions, as exemplified below. Accordingly, ROHM shall not be in any way responsible or liable for any damages, expenses or losses arising from the use of any ROHM's Products under any special or extraordinary environments or conditions. If you intend to use our Products under any special or extraordinary environments or conditions (as exemplified below), your independent verification and confirmation of product performance, reliability, etc. prior to use, must be necessary:
 - Use of our Products in any types of liquid, including water, oils, chemicals, and organic solvents
 - Use of our Products outdoors or in places where the Products are exposed to direct sunlight or dust
 - Use of our Products in places where the Products are exposed to sea wind or corrosive gases, including Cl₂, H₂S, NH₃, SO₂, and NO₂
 - Use of our Products in places where the Products are exposed to static electricity or electromagnetic waves
 - Use of our Products in proximity to heat-producing components, plastic cords, or other flammable items
 - Sealing or coating our Products with resin or other coating materials
 - Use of our Products without cleaning residue of flux (even if you use no-clean type fluxes, cleaning residue of flux is recommended); or Washing our Products by using water or water-soluble cleaning agents for cleaning residue after soldering
 - Use of the Products in places subject to dew condensation
- The Products are not subject to radiation-proof design.
- Please verify and confirm characteristics of the final or mounted products in using the Products.
- In particular, if a transient load (a large amount of load applied in a short period of time, such as pulse. is applied, confirmation of performance characteristics after on-board mounting is strongly recommended. Avoid applying power exceeding normal rated power; exceeding the power rating under steady-state loading condition may negatively affect product performance and reliability.
- De-rate Power Dissipation (Pd) depending on Ambient temperature (Ta). When used in sealed area, confirm the actual ambient temperature.
- Confirm that operation temperature is within the specified range described in the product specification.
- ROHM shall not be in any way responsible or liable for failure induced under deviant condition from what is defined in this document.

Precaution for Mounting / Circuit board design

- When a highly active halogenous (chlorine, bromine, etc.) flux is used, the residue of flux may negatively affect product performance and reliability.
- In principle, the reflow soldering method must be used; if flow soldering method is preferred, please consult with the ROHM representative in advance.

For details, please refer to ROHM Mounting specification

Precautions Regarding Application Examples and External Circuits

1. If change is made to the constant of an external circuit, please allow a sufficient margin considering variations of the characteristics of the Products and external components, including transient characteristics, as well as static characteristics.
2. You agree that application notes, reference designs, and associated data and information contained in this document are presented only as guidance for Products use. Therefore, in case you use such information, you are solely responsible for it and you must exercise your own independent verification and judgment in the use of such information contained in this document. ROHM shall not be in any way responsible or liable for any damages, expenses or losses incurred by you or third parties arising from the use of such information.

Precaution for Electrostatic

This Product is electrostatic sensitive product, which may be damaged due to electrostatic discharge. Please take proper caution in your manufacturing process and storage so that voltage exceeding the Products maximum rating will not be applied to Products. Please take special care under dry condition (e.g. Grounding of human body / equipment / solder iron, isolation from charged objects, setting of ionizer, friction prevention and temperature / humidity control).

Precaution for Storage / Transportation

1. Product performance and soldered connections may deteriorate if the Products are stored in the places where:
 - [a] the Products are exposed to sea winds or corrosive gases, including Cl₂, H₂S, NH₃, SO₂, and NO₂
 - [b] the temperature or humidity exceeds those recommended by ROHM
 - [c] the Products are exposed to direct sunshine or condensation
 - [d] the Products are exposed to high Electrostatic
2. Even under ROHM recommended storage condition, solderability of products out of recommended storage time period may be degraded. It is strongly recommended to confirm solderability before using Products of which storage time is exceeding the recommended storage time period.
3. Store / transport cartons in the correct direction, which is indicated on a carton with a symbol. Otherwise bent leads may occur due to excessive stress applied when dropping of a carton.
4. Use Products within the specified time after opening a humidity barrier bag. Baking is required before using Products of which storage time is exceeding the recommended storage time period.

Precaution for Product Label

QR code printed on ROHM Products label is for ROHM's internal use only.

Precaution for Disposition

When disposing Products please dispose them properly using an authorized industry waste company.

Precaution for Foreign Exchange and Foreign Trade act

Since our Products might fall under controlled goods prescribed by the applicable foreign exchange and foreign trade act, please consult with ROHM representative in case of export.

Precaution Regarding Intellectual Property Rights

1. All information and data including but not limited to application example contained in this document is for reference only. ROHM does not warrant that foregoing information or data will not infringe any intellectual property rights or any other rights of any third party regarding such information or data. ROHM shall not be in any way responsible or liable for infringement of any intellectual property rights or other damages arising from use of such information or data.:
2. No license, expressly or implied, is granted hereby under any intellectual property rights or other rights of ROHM or any third parties with respect to the information contained in this document.

Other Precaution

1. This document may not be reprinted or reproduced, in whole or in part, without prior written consent of ROHM.
2. The Products may not be disassembled, converted, modified, reproduced or otherwise changed without prior written consent of ROHM.
3. In no event shall you use in any way whatsoever the Products and the related technical information contained in the Products or this document for any military purposes, including but not limited to, the development of mass-destruction weapons.
4. The proper names of companies or products described in this document are trademarks or registered trademarks of ROHM, its affiliated companies or third parties.

General Precaution

1. Before you use our Products, you are requested to carefully read this document and fully understand its contents. ROHM shall not be in any way responsible or liable for failure, malfunction or accident arising from the use of any ROHM's Products against warning, caution or note contained in this document.
2. All information contained in this document is current as of the issuing date and subject to change without any prior notice. Before purchasing or using ROHM's Products, please confirm the latest information with a ROHM sales representative.
3. The information contained in this document is provided on an "as is" basis and ROHM does not warrant that all information contained in this document is accurate and/or error-free. ROHM shall not be in any way responsible or liable for any damages, expenses or losses incurred by you or third parties resulting from inaccuracy or errors of or concerning such information.